

THIS DOCUMENT IS SUBJECT TO CHANGE WITHOUT NOTICE. IT IS CONFIDENTIAL AND A PROPERTY OF Amphenol LTW. DISCLOSURE TO THIRD PARTY HAS TO BE AUTHORIZED BY Amphenol LTW.

REV.	ECN NO.	DATE	SIGN	DESCRIPTION
B	LEN-880486	2008/07/18	Li Xiu Zhi	Change Dimension
C	LEN1741244	2017/04/18	Ruru	Change Logo
D	CI90268	2019/02/19	Ruru	Modify Note

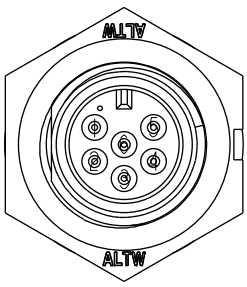

Pin Assignments  
Front View 前視圖

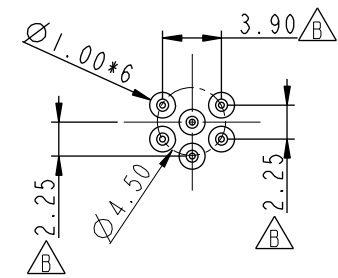
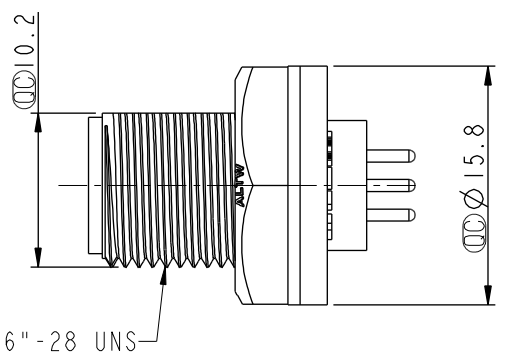

6 Pin Male Connector  
Male Pin PCB Layout  
6 Pin 公座公Pin  
PCB 挖孔位置尺寸圖

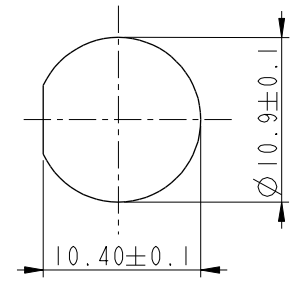

Recommended Panel Cut-Out

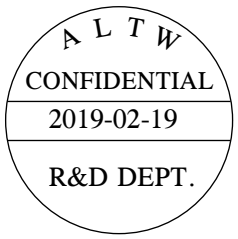

7/16"-28 UNS

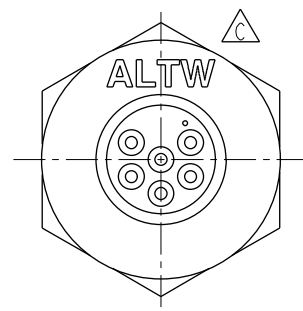
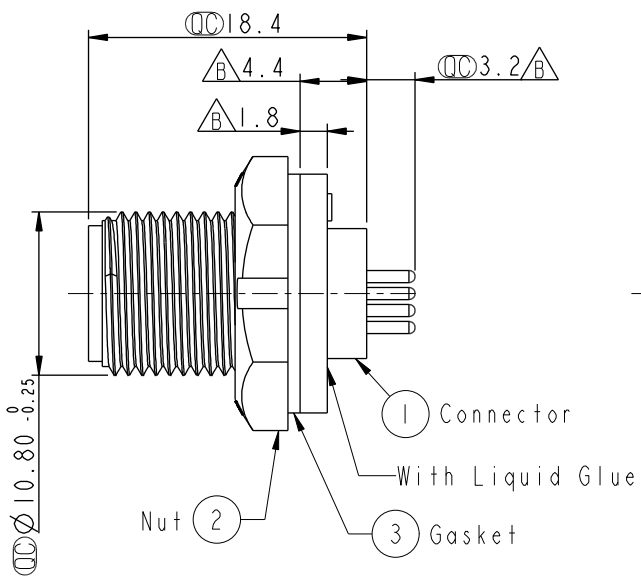

Note:  $\triangle B$   $\triangle D$

- \*  $\text{⌀}$  Important Dimension.
- \* Waterproof Rate: IP67, Unmated
- \* Housing: Thermoplastic, Black
- \* Pin: Copper Alloy, Gold Plated
- \* Nut: Thermoplastic, Black
- \* Gasket: Rubber, Black
- $\triangle B$ \* Use with waterproof cap or dust cap  
For Panel Thickness Max: 4.0mm
- $\triangle B$ \* Use without waterproof cap or dust cap  
For Panel Thickness Max: 5.0mm
- \* Gasket and Nut are packed separately in PE bags.

UNIT: mm		
TOLERANCE	.X ±0.25	
	.XX ±0.1	
	.XXX ±0.05	
ANGLES	±1°	

TITLE SCREW TYPE CONN. FOR PANEL MOUNT 6PIN M CONN. M PIN (2A)			
SCALE 2:1	SIZE A4	SHEET 1 OF 1	
REV. D	WC-REV. A.2	$\text{⌀}$ : Inspection item	

**Amphenol LTW**  
安費諾亮泰企業股份有限公司

ITEM NO. AU-06PMMP-SC7001	DRAWN BY Ruru	DATE 2019-02-19
DWG NO. AU-06PMMP-SC7001	CHECKED BY Rita	DATE 2019-02-19
CUSTOMER ALTW	APPROVED BY Max	DATE 2019-02-19

## X-ON Electronics

Largest Supplier of Electrical and Electronic Components

*Click to view similar products for [Sensor Cables / Actuator Cables](#) category:*

*Click to view products by [Amphenol](#) manufacturer:*

Other Similar products are found below :

[60963](#) [60964](#) [M83513/19-F01CP](#) [703000D02F2002](#) [703001D02F0602](#) [703001D02F300](#) [704000D02F120](#) [773032K02F030](#) [802027107404-1](#)  
[802027213811-1](#) [804001A09M150](#) [805001A09M0502](#) [84914-0235](#) [84914-0237](#) [885030A09M020](#) [8R4J30E03C3003](#) [1200651332](#)  
[1200651713](#) [1200660844](#) [1200660845](#) [1200661173](#) [1200680071](#) [1200720053](#) [1200720081](#) [1200720099](#) [1200720217](#) [1200800231](#)  
[1200860125](#) [1200870123](#) [1200980102](#) [1200650267](#) [1200650298](#) [1200660183](#) [1200660782](#) [1200660849](#) [1200661295](#) [1200661297](#)  
[1200661342](#) [1200661343](#) [1200670080](#) [1200670220](#) [1200680331](#) [1200720252](#) [1200730184](#) [1200860344](#) [1200870359](#) [1200870643](#)  
[1200980008](#) [1200980031](#) [1210502211](#)