

REVISIONS					
REV	ECO	DESCRIPTION	DATE	BY	APPR
A1	--	RELEASE NEW DRAWING	18/MAR/20	PETER	TOMMY

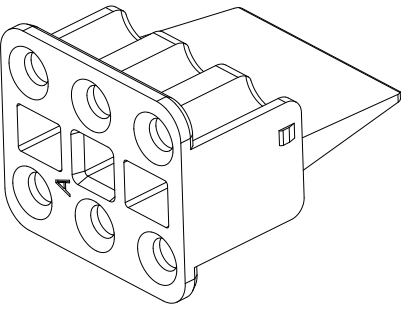
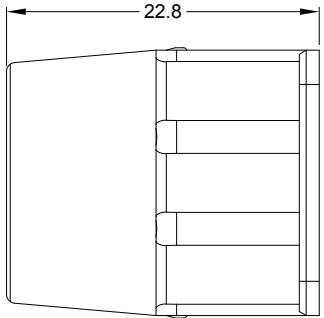
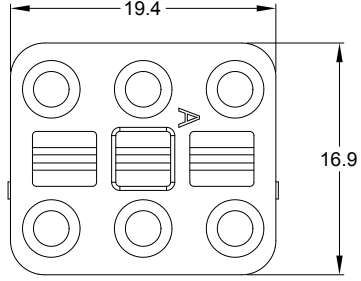
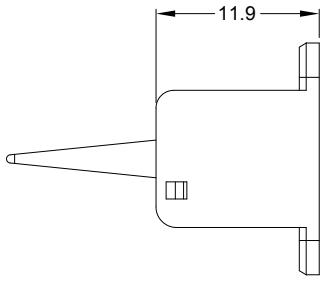

- NOTES: UNLESS OTHERWISE SPECIFIED
1. MATERIAL: THERMOPLASTIC; COLOR: SEE SHEET 2
  2. RoHS COMPLIANT
  3. CAVITIES: 6
  - 4 KEYED: SEE SHEET 2
  5. USE WITH CONNECTORS ATP06-6S\*  
(\* = MODIFICATIONS AND COLORS)
  6. ALL DIMENSIONS ARE FOR REFERENCE USE ONLY.

QUANTITY	AWP-6SX	PART NUMBER	DESCRIPTION	ITEM								
<b>MATERIALS LIST</b>												
<b>UNLESS OTHERWISE SPECIFIED</b> 1) All dimensions are in metric(mm). 2) Tolerances are as follows: 1 PL DEC ±0.30    Fractions ±1/64 2 PL DEC ±0.15    Angles ±1° 3 PL DEC ±0.08 3) Note reference =		<b>SIGNATURES</b> <b>DATE</b> DRAWN: <b>PETER.YANG</b> 18/MAR/20 CHECKED: <b>ORION.LI</b> 19/MAR/20 ENGINEER: APPROVAL: <b>TOMMY.XIE</b> 20/MAR/20 CUSTOMER:		<h1>Amphenol</h1> Sine Systems - www.amphenol-sine.com 44724 Morley Drive Clinton Township, MI 48036								
MATERIAL SPECIFICATIONS:		THIS DRAWING IS SUPPLIED FOR INFORMATION ONLY. DESIGN FEATURES, SPECIFICATIONS AND PERFORMANCE DATA SHOWN HEREON ARE THE PROPERTY OF THE AMPHENOL CORPORATION. NO RIGHTS OF REPRODUCTION ARE IMPLIED. ALL DIMENSIONS ARE SUBJECT TO NORMAL MANUFACTURING VARIATIONS.		S-WEDGELOCK, 6 POSITION, ATP SERIES  <table border="1"> <tr> <td>SIZE</td> <td>TYPE</td> <td>DWG NO:</td> <td>REVISION</td> </tr> <tr> <td><b>A</b></td> <td><b>C-</b></td> <td><b>AWP-6SX</b></td> <td><b>A1</b></td> </tr> </table>	SIZE	TYPE	DWG NO:	REVISION	<b>A</b>	<b>C-</b>	<b>AWP-6SX</b>	<b>A1</b>
SIZE	TYPE	DWG NO:	REVISION									
<b>A</b>	<b>C-</b>	<b>AWP-6SX</b>	<b>A1</b>									
PROCESS SPECIFICATIONS:		SCALE: NONE		SHEET 1 OF 2								
NEXT ASSY:												

REVISIONS					
REV	ECO	DESCRIPTION	DATE	BY	APPR
A1	--	RELEASE NEW DRAWING	18/MAR/20	PETER	TOMMY

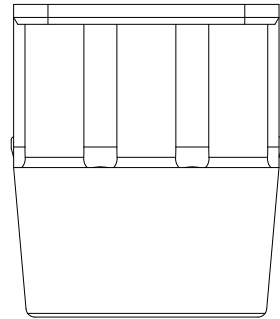
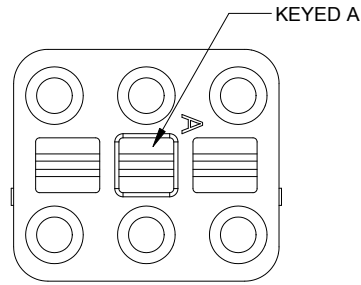

**AWP-6SA**  
GRAY

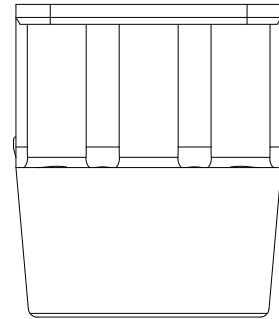
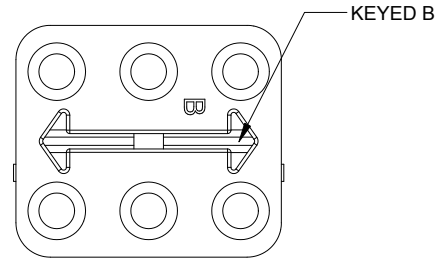

**AWP-6SB**  
BLACK

QUANTITY	PART NUMBER	DESCRIPTION	ITEM
<b>MATERIALS LIST</b>			

<p><b>UNLESS OTHERWISE SPECIFIED</b></p> <p>1) All dimensions are in metric(mm).                  2) Tolerances are as follows:                  1 PL DEC ±0.30      Fractions ±1/64                  2 PL DEC ±0.15      Angles ±1°                  3 PL DEC ±0.08</p> <p>3) Note reference = </p>	<p><b>SIGNATURES</b></p> DRAWN: <b>PETER.YANG</b> 18/MAR/20 CHECKED: <b>ORION.LI</b> 19/MAR/20 ENGINEER: APPROVAL: <b>TOMMY.XIE</b> 20/MAR/20		<h1>Amphenol</h1> <p>Sine Systems - www.amphenol-sine.com                  44724 Morley Drive                  Clinton Township, MI 48036</p>		
	MATERIAL SPECIFICATIONS:  PROCESS SPECIFICATIONS:  NEXT ASSY:				<p>S-WEDGELOCK, 6 POSITION, ATP SERIES</p>
	THIS DRAWING IS SUPPLIED FOR INFORMATION ONLY. DESIGN FEATURES, SPECIFICATIONS AND PERFORMANCE DATA SHOWN HEREON ARE THE PROPERTY OF THE AMPHENOL CORPORATION. NO RIGHTS OF REPRODUCTION ARE IMPLIED. ALL DIMENSIONS ARE SUBJECT TO NORMAL MANUFACTURING VARIATIONS.		SIZE: <b>A</b> TYPE: <b>C-</b>	DWG NO: <b>AWP-6SX</b>	REVISION: <b>A1</b>
	SCALE: <b>NONE</b>		SHEET <b>2</b> OF <b>2</b>		

## X-ON Electronics

Largest Supplier of Electrical and Electronic Components

*Click to view similar products for [Automotive Connectors](#) category:*

*Click to view products by [Amphenol](#) manufacturer:*

Other Similar products are found below :

[003-018-000](#) [60403001](#) [60993906-B](#) [M902-2131](#) [M902-2161](#) [72.330.1035.1](#) [73.353.4028.0](#) [F119300-B](#) [F166900](#) [F258300-B](#) [F358300-B](#)  
[F407400](#) [F444110](#) [F487000](#) [F509500B-B](#) [827153-1](#) [8N1515-32-24P](#) [9-1326729-8](#) [925474-1](#) [928905-1](#) [964562-4](#) [968782-1](#) [GT17SA-8DS-](#)  
[HU](#) [98891-1012](#) [98947-1016](#) [12004475-L](#) [12010290](#) [12010309-B](#) [12015454](#) [12020219-B](#) [12020308](#) [12041318-B](#) [12052225-L](#) [12052466](#)  
[12059125](#) [12064869](#) [12004327-B](#) [12010503-B](#) [12015308](#) [12015384](#) [12015909](#) [1-21030-1](#) [12041254](#) [12041318](#) [12047946-B](#) [12047957](#)  
[12047957-L](#) [12059473](#) [12066261](#) [12110546](#)