

Description

Developed in the late 1940's, the BNC is a miniature version of the Type C. BNC stands for Bayonet Neill Concelman and is available in 50 Ohm and 75 Ohm impedance versions.

The BNC product line is a miniature quick connect / disconnect RF connector. It features two bayonet lugs on the female connector; mating is achieved with only a quarter turn of the coupling nut.

Primary Applications - Ideally suited for cable termination for miniature to subminiature coaxial cable (RG-58, 59, to RG-179, RG-316, etc.)

Features/Benefits

- Bayonet coupling mechanism provides quick mating and unmating.
- 50 and 75 ohm impedance designs allow customers to match impedance to system requirements.
- 50 and 75 ohm connectors are intermateable to ensure nondestructive mating.
- Three grades of connectors are available for military, industrial and commercial applications

Applications

- Antennas
- Automotive (GPS)
- Base Stations
- Broadcast (75 ohm)
- Cable Assemblies
- Cable Modems
- Components
- Computers/LANs
- Instrumentation
- Network Analyzers
- Oscilloscopes
- Medical Equipment
- Mil-Aerospace
- Networks
- Radios
- Satcom
- Surge Protection
- Telecom.

Specifications

Electrical

Impedance	50 ohm	75 ohm
Frequency Range	0-4 GHz	0-1 GHz
Working Voltage	500 Volts rms.	500 Volts rms.
Dielectric Withstanding Voltage	1500 Volts rms.	1500 Volts rms.
VSWR	1.3 max. 0-4 GHz	1.05+0.1f(GHz) DC to 1 GHz
Contact Resistance	Center contact 1.5 milliohm Outer contact 1.0 milliohm	Center contact 1.5 milliohm Outer contact 1.0 milliohm

Material

Center Contact male	Brass, Gold or Silver plated
Center Contact female	Phosphor Bronze (nominal) or Beryllium Copper, Gold or Silver plated
Metal parts	Brass, nickel plated
Insulators	Teflon, Delrin, PBT polyester
Clamp gaskets	Silicone rubber, Synthetic rubber
Crimp ferrule	Annealed copper, nickel plated

Plug

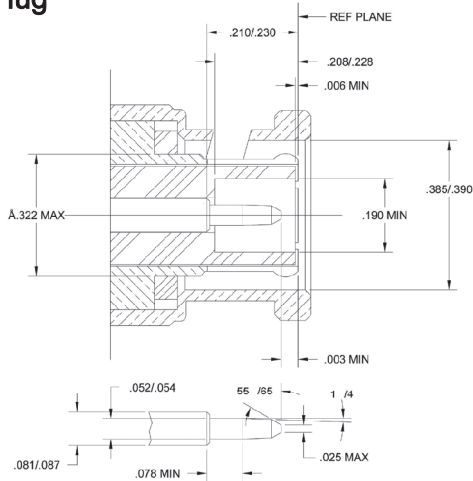

Jack

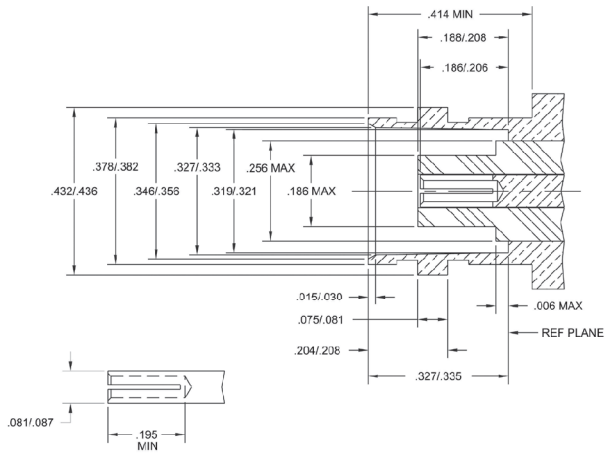

Straight Crimp Plug - Single Crimp

P.N.	Cable Group	Pit.	Ins.	Imp.	Crimp Tool
B1111L1-001-ND3G-01-50	01	Nickel	Delrin	50	5
B1111L1-001-ND3G-03-50	03	Nickel	Delrin	50	5

Remark: Only for Solid Center Conductor Cable

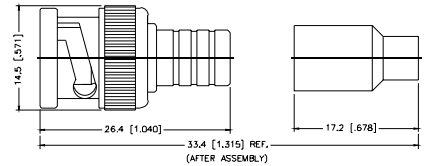
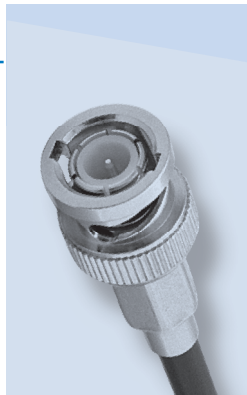

Assembly Instruction J - page 236

Straight Crimp Plug - Captive Contact - Standard Cable

P.N.	Cable Group	Pit.	Ins.	Imp.	Crimp Tool
B1121A1-NT3G-1-50	01	Nickel	Teflon	50	3 or 4
B1121A1-ND3G-1-50	01	Nickel	Delrin	50	3 or 4
B1121BA-001-ND3G-1A-50	01A	Nickel	Delrin	50	3 or 4
B1121AA-NT3G-1B-50	01B	Nickel	Teflon	50	3 or 4
B1121A1-ND3G-3-50	03	Nickel	Delrin	50	4
B1121A1-ND3G-3-75	03	Nickel	Delrin	75	4
B1121A9-NT3G-3-75*	03	Nickel	Teflon	75	7
B1121A1-ND3G-3A-75	03A	Nickel	Delrin	75	4
B1121A9-009-NT30G-3A-75*	03A	Nickel	Teflon	75	4
B1121A6-NT3G-7-50	07	Nickel	Teflon	50	4 + 6
B1121A6-NT3G-7A-50	07A	Nickel	Teflon	50	4 + 6
B1121A1-ND3G-7B-50	07B	Nickel	Delrin	50	4
B1121A6-NT3G-7C-50	07C	Nickel	Teflon	50	6
B1121A2-NT3G-7D-50	07D	Nickel	Teflon	50	4 + 6
B1121A6-NT3G-7E-75	07E	Nickel	Teflon	75	2 + 6
B1121A6-NT3G-7F-75	07F	Nickel	Teflon	75	2 + 6
B1121A1-ND3G-8-75	08	Nickel	Delrin	75	5
B1121CA-002-ND3G-8A-75	08A	Nickel	Delrin	75	5
B1121A9-NT15G-8A-75*	08A	Nickel	Teflon	75	2 + 5
B1121A9-NT15G-8B-75*	08B	Nickel	Teflon	75	5
B1121A1-ND3G-15-75	15	Nickel	Delrin	75	5
B1121A1-NT3G-15-75*	15	Nickel	Teflon	75	5
B1121C1-ND3G-15A-75	15A	Nickel	Delrin	75	5
B1121A9-003-NT3G-75	16	Nickel	Teflon	75	.180 hex
B1121A9-003-NT3G-75	16A	Nickel	Teflon	75	.180 hex
B1121A9-NT15G-18-75*	18	Nickel	Teflon	75	2 + 4
B1121A9-NT15G-19-75*	19	Nickel	Teflon	75	9
B1121A1-NT3G-22-75	22	Nickel	Teflon	75	.180 hex
Diecast Shell					
B1121BA-001-ND3G-1-50	01	Nickel	Delrin	50	3 or 4
B1121B1-ND3G-3-50	03	Nickel	Delrin	50	4
B1121B1-ND3G-3-75	03	Nickel	Delrin	75	4

* Center contact .053" diameter, 30 μ" Au.
True 75 ohm. Use .044 hex or 12-indent crimp

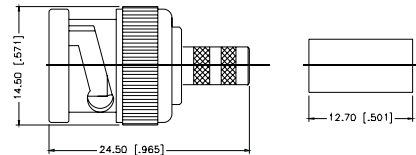
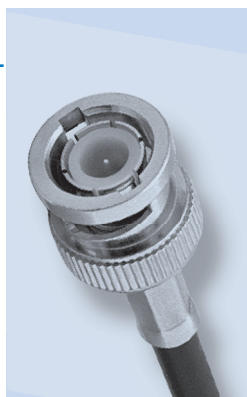

Assembly Instruction J - page 236

Straight Crimp Plug - Pin-in-Pin - Miniature Cable

P.N.	Cable Group	Pit.	Ins.	Imp.	Crimp Tool
Brass Shell					
B1121G1-ND3G-5-50	05	Nickel	Delrin	50	2
B1121G1-ND3G-6-75	06	Nickel	Delrin	75	2
Diecast Shell					
B1121H1-001-ND3G-5-50	05	Nickel	Delrin	50	1 or 2
B1121H1-001-ND3G-6-75	06	Nickel	Delrin	75	2

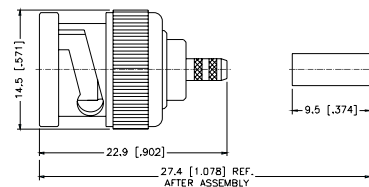
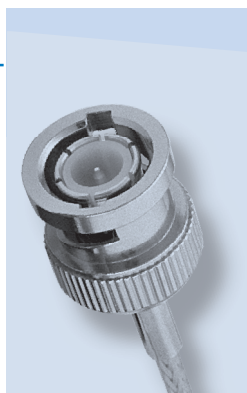

Assembly Instruction J - page 236

Straight Crimp Plug - Miniature Cable

P.N.	Cable Group	Pit.	Ins.	Imp.	Crimp Tool
Brass Shell					
B1121E9-002-NTPX3G-6-75	06	Nickel	TPX	75	3
Diecast Shell					
B1121F9-003-NTPX3G-6-75	06	Nickel	TPX	75	3
Remark: TPX Insulator/75 ohm AVAILABLE ONLY					

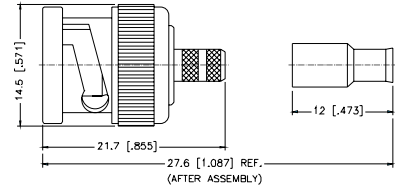
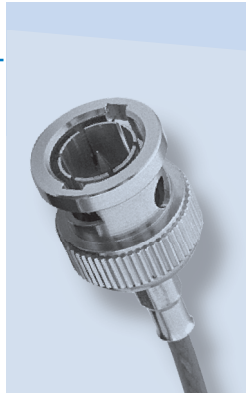

Assembly Instruction K - page 237

Straight Crimp Plug - Captive Contact - Plenum Cable

P.N.	Cable Group	Pit.	Ins.	Imp.	Crimp Tool
B1121CA-001-ND3G-4A-75	04A	Nickel	Delrin	75	4

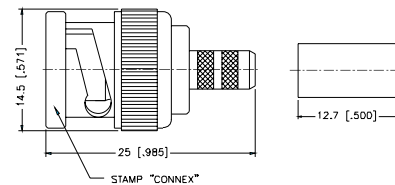
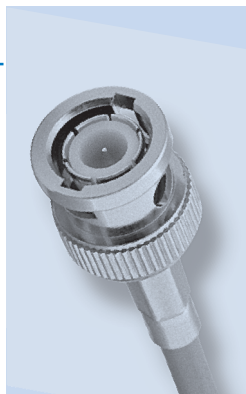

Assembly Instruction J - page 236

Straight Crimp Plug - Captive Contact - Miniature Cable

P.N.	Cable Group	Pit.	Ins.	Imp.	Crimp Tool
Brass Shell					
B1121E1-ND3G-5-50	05	Nickel	Delrin	50	3
B1121E1-ND3G-5A-50	05A	Nickel	Delrin	50	3
B1121E1-ND3G-6-50	06	Nickel	Delrin	50	3
B1121E2-003-ND3G-6-75	06	Nickel	Delrin	75	3
B1121E1-ND3G-6A-75	06A	Nickel	Delrin	75	9
B1121H1-001-ND3G-14-50	14	Nickel	Delrin	50	9
B1121A1-ND3G-16-75	16	Nickel	Delrin	75	1 or 2
B1121A1-ND3G-16A-75	16A	Nickel	Delrin	75	1 or 2
B1121A9-010-NT30G-16-75*	16	Nickel	Teflon	75	3
B1121A9-010-NT30G-16A-75	16A	Nickel	Teflon	75	3
Diecast Shell					
B1121FA-001-ND3G-5-50	05	Nickel	Delrin	50	3
B1121FA-001-ND3G-6-50	06	Nickel	Delrin	50	3

Remark: With teflon sleeve/Hex crimp size. 178"

* Center contact .053" diameter, 30 μ" Au.

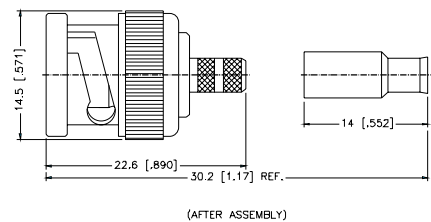
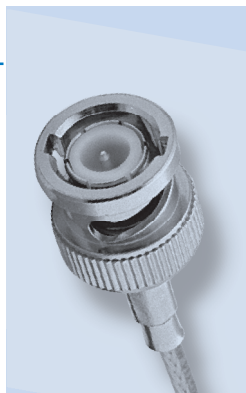

Assembly Instruction K - page 237

Straight Solder Plug - Semi-Rigid Cable

P.N.	Cable Group	Plt.	Ins.	Imp.	Crimp Tool
B1181A1-W/3GT3G-10-50	10	Nickel/Gold	Teflon	50	N/A
B1181A1-W/NT30GA-10-75	10	Nickel/Gold	Teflon	75	N/A
B1181A1-NT3G-11-50	11	Nickel/Gold	Teflon	50	N/A

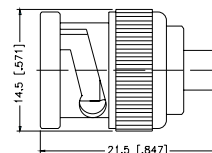

Assembly Instruction E - page 231

Right Angle Crimp/Solder Plug - Standard Cable

P.N.	Cable Group	Plt.	Ins.	Imp.	Crimp Tool
Brass Shell					
B1112A1-ND3G-1-50	01	Nickel	Delrin	50	3 or 4
B1112A1-ND3G-1A-50	01A	Nickel	Delrin	50	3 or 4
B1112A1-NT3G-1B-50	01B	Nickel	Teflon	50	3 or 4
B1112A1-ND3G-3-50	03	Nickel	Delrin	50	4
B1112A1-ND3G-3-75	03	Nickel	Delrin	75	4
B1112A6-NT3G-3-75*	03	Nickel	Teflon	75	4
B1112A1-NT3G-1-50	01	Nickel	Teflon	50	3 or 4
B1112A1-NT3G-3-75	03	Nickel	Teflon	75	4
B1112A4-NT3G-7-50	07	Nickel	Teflon	50	6
B1112A4-NT3G-7A-50	07A	Nickel	Teflon	50	6
B1112A4-ND3G-7B-50	07B	Nickel	Delrin	50	3 or 4
B1112A4-NT3G-7C-50	07C	Nickel	Teflon	50	6
B1112A6-NT3G-18-75*	18	Nickel	Teflon	75	4
B1112A6-NT3G-19-75*	19	Nickel	Teflon	75	9
Diecast Shell					
B1112B1-001-ND3G-1-50	01	Nickel	Delrin	50	3 or 4
B1112B1-001-ND3G-3-50	03	Nickel	Delrin	50	4
B1112B1-001-ND3G-3-75	03	Nickel	Delrin	75	4

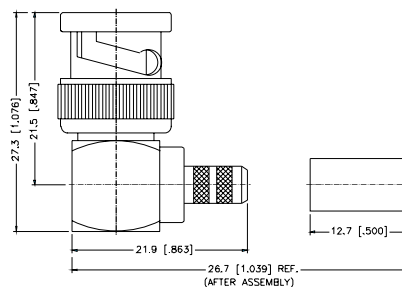

Assembly Instruction I - page 235

* Center contact .052" diameter, 20u" Au, Tin 75 Ohm, Use .044 hex or 12-indent edmp

Right Angle Crimp/Solder Plug - Miniature Cable

P.N.	Cable Group	Plt.	Ins.	Imp.	Crimp Tool
Brass Shell					
B1112E1-ND3G-5-50	05	Nickel	Delrin	50	3
B1112E1-ND3G-5A-50	05A	Nickel	Delrin	50	9
B1112E1-ND3G-6-75	06	Nickel	Delrin	75	9
B1112E1-ND3G-6A-75	06A	Nickel	Delrin	75	3
B1112E1-ND3G-16-75	16	Nickel	Delrin	75	9
B1112E1-ND3G-16A-75	16A	Nickel	Delrin	75	9

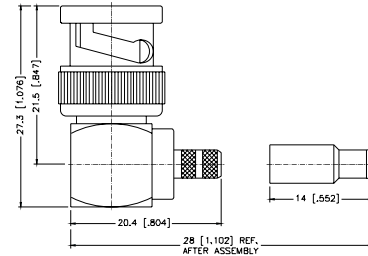
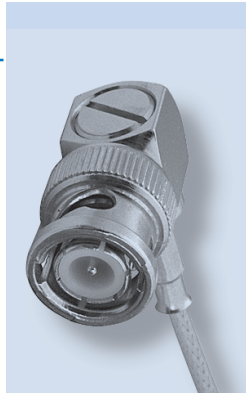

Assembly Instruction I - page 235

Right Angle Solder Plug - Semi-Rigid Cable

P.N.	Cable Group	Plt.	Ins.	Imp.	Crimp Tool
B1182A1-N/3GT3G-10-50	10	Nickel/Gold	Teflon	50	N/A
B1182A1-N/NT30GA-11-50	11	Nickel/Gold	Teflon	50	N/A

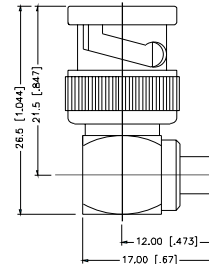
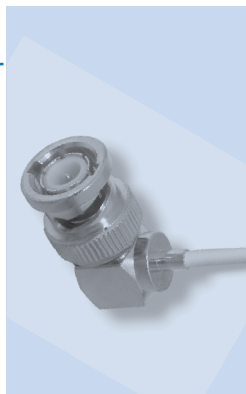

Assembly Instruction F - page 232

Right Angle Crimp/Crimp Plug - Standard Cable

P.N.	Cable Group	Plt.	Ins.	Imp.	Crimp Tool
Brass Shell					
B1122A1-ND3G-1-50	01	Nickel	Delrin	50	4
B1122A1-ND3G-3-50	03	Nickel	Delrin	50	4
B1122A1-ND3G-3-75	03	Nickel	Delrin	75	4
B1122A1-NT3G-8-75	08	Nickel	Teflon	75	5
B1122A1-NT3G-15-75	15	Nickel	Teflon	75	5
Diecast Shell					
B1122B1-001-ND3G-1-50	01	Nickel	Delrin	50	3 or 4
B1122B1-001-ND3G-3-75	03	Nickel	Delrin	75	4
B1122B1-001-NT3G-75	16A,16	Nickel	Teflon	75	.180 hex

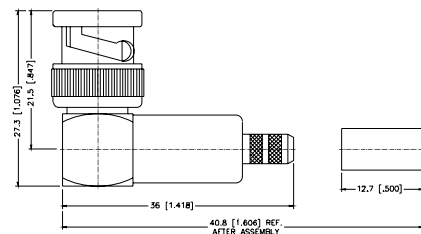
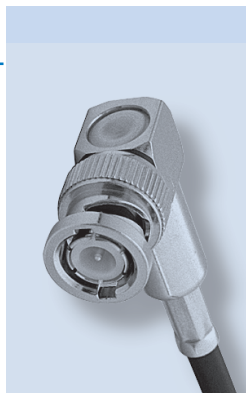

Assembly Instruction S - page 245

Right Angle Crimp/Crimp Plug - Miniature Cable

P.N.	Cable Group	Pit.	Ins.	Imp.	Crimp Tool
Brass Shell					
B1122E1-002-ND3G-5-50	05	Nickel	Delrin	50	3
B1122E1-ND3G-6-75	06	Nickel	Delrin	75	3
Diecast Shell					
B1122F1-001-ND3G-5-50	05	Nickel	Delrin	50	3
B1122F1-001-ND3G-6-75	06	Nickel	Delrin	75	3

Remark: With teflon sleeve Hex. crimp size .178"

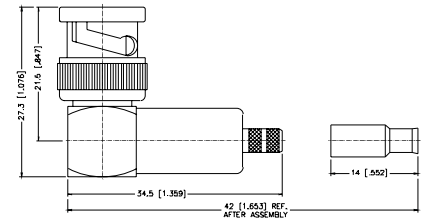
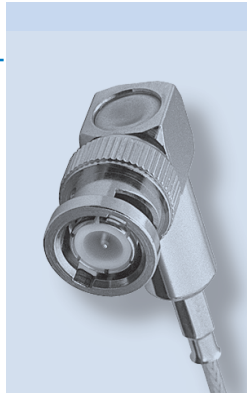

Assembly Instruction S - page 245

Straight Crimp Jack - Miniature Cable

P.N.	Cable Group	Pit.	Ins.	Imp.	Crimp Tool
B6121E1-ND3G-5-50	05	Nickel	Delrin	50	9
B6121E1-ND3G-5A-50	05A	Nickel	Delrin	50	9
B6121E1-ND3G-6-75	06	Nickel	Delrin	75	9
B6121E1-ND3G-6A-75	06A	Nickel	Delrin	75	9
B6121G1-NT3G-14-50	14	Nickel	Teflon	50	9
B6121B1-ND3G-16-75	16	Nickel	Delrin	75	9

Remark: With teflon sleeve, Hex crimp size .178"

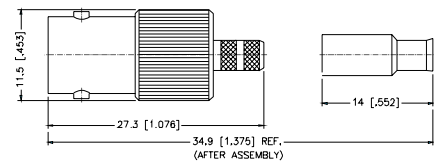
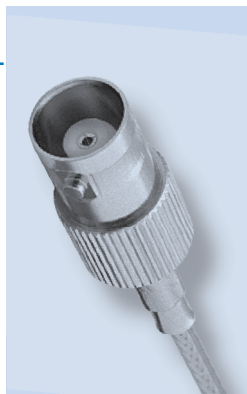

Assembly Instruction K - page 237

Straight Crimp Jack - Standard Cable

P.N.	Cable Group	Pit.	Ins.	Imp.	Crimp Tool
Captured					
B6121A1-NT3G-1-50	01	Nickel	Teflon	50	3 or 4
B6121B1-ND3G-1-50	01	Nickel	Delrin	50	3 or 4
B6121A1-004-ND3G-1A-50	01A	Nickel	Delrin	50	3 or 4
B6121A1-NT3G-1B-50	01B	Nickel	Teflon	50	4
B6121A1-NT3G-3-50	03	Nickel	Teflon	50	4
B6121A1-NT3G-3-75	03	Nickel	Teflon	75	4
B6121B1-ND3G-3-50	03	Nickel	Delrin	50	4
B6121A1-NT3G-3A-75	03A	Nickel	Teflon	75	4
B6121A1-NT3G-7B-50	07B	Nickel	Teflon	50	4
B6121A6-NT3G-7C-50	07C	Nickel	Teflon	50	1 + 6
B6121A2-NT3G-8A-75*	08A	Nickel	Teflon	75	2 + 5
B6121A2-NT3G-8B-75*	08B	Nickel	Teflon	75	2 + 5
B6121A1-NT3G-15-75	15	Nickel	Teflon	75	5
B6121A2-NT3G-18-75*	18	Nickel	Teflon	75	4
B6121A2-NT3G-19-75*	19	Nickel	Teflon	75	9

* Center contact .052" diameter, 30µ" Au. True 75 ohm.

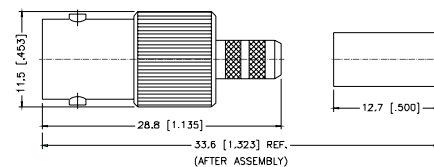
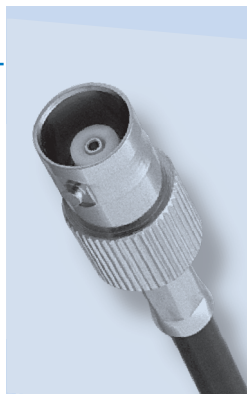

Assembly Instruction J - page 236

Straight Solder Jack - Semi-Rigid Cable

P.N.	Cable Group	Pit.	Ins.	Imp.	Crimp Tool
B6181A1-W/3GT3G-10-50	10	Nickel/Gold	Teflon	50	N/A
B6181A1-W/3GT3G-11-50	11	Nickel/Gold	Teflon	50	N/A

Remark: With teflon sleeve, Hex crimp size .178"

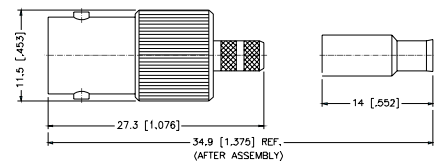
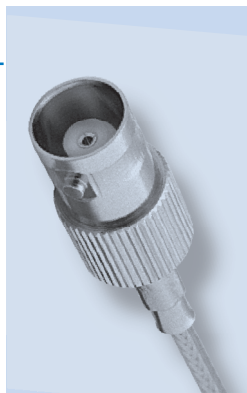

Assembly Instruction E - page 231

Bulkhead Crimp Jack - Snap-In Panel - Miniature Cable

P.N.	Cable Group	Plt.	Ins.	Imp.	Crimp Tool
B632100-001-NT3G-5-50	05	Nickel	Teflon	50	3

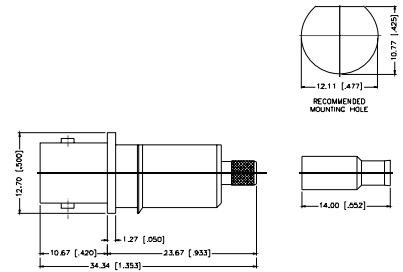

Assembly Instruction L - page 238

Bulkhead Crimp Jack - Standard Cable

P.N.	Cable Group	Plt.	Ins.	Imp.	Crimp Tool
Teflon/Captured					
B6421A1-NT3G-1-50	01	Nickel	Teflon	50	4
B6421A1-ND3G-1A-50	01A	Nickel	Delrin	50	4
B6421A1-NT3G-1B-50	01B	Nickel	Teflon	50	3 or 4
B6421A1-NT3G-3-50	03	Nickel	Teflon	50	4
B6421A1-NT3G-3-75	03	Nickel	Teflon	75	4
B6421A1-NT3G-3A-50	03A	Nickel	Teflon	50	4
B6421A1-NT3G-7B-50	07B	Nickel	Teflon	50	4
B6421A6-NT3G-7C-50	07C	Nickel	Teflon	50	1 + 6
B6421A1-NT3G-15-75	15	Nickel	Teflon	75	3
B6421A1-003-NT3G-75	16,16A	Nickel	Teflon	75	.180 hex
Delrin/Non Captured					
B6421B1-ND3G-1-50	01	Nickel	Delrin	50	3 or 4
B6421B1-ND3G-3-50	03	Nickel	Delrin	50	4
B6421B1-ND3G-3-75	03	Nickel	Delrin	75	4

Remark: 3.5 [.138] Max. panel thickness

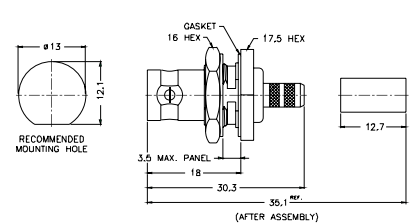
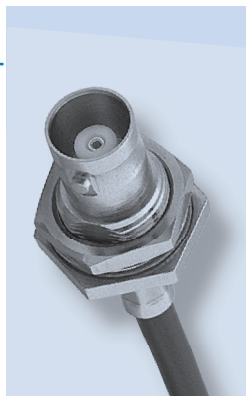

Assembly Instruction J - page 236

P.N.	Cable Group	Plt.	Ins.	Imp.	Crimp Tool
B6421A2-NT3G-1-50	01	Nickel	Teflon	50	4
B6421A2-NT3G-3-75	03	Nickel	Teflon	75	4

Remark: 6.5 [.256] Max. panel thickness

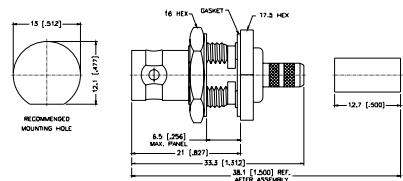
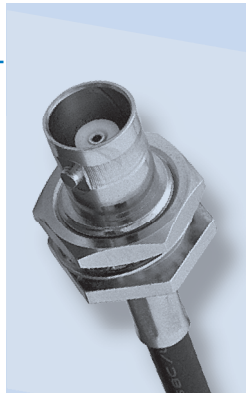

Assembly Instruction J - page 236

Bulkhead Isolated Crimp Jack - Miniature Cable

P.N.	Cable Group	Pit.	Ins.	Imp.	Crimp Tool
B6721E1-NT3G-5-50	05	Nickel	Teflon	50	9
B6721E1-NT3G-6-75	06	Nickel	Teflon	75	9

Remark: 6.0 [.236] Max. panel thickness

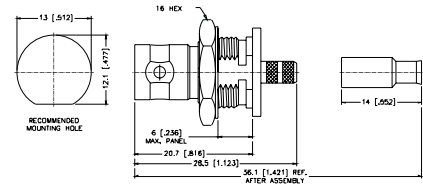
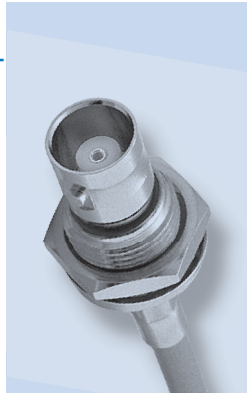

Assembly Instruction J - page 236

Bulkhead Crimp Jack - Miniature Cable

P.N.	Cable Group	Pit.	Ins.	Imp.	Crimp Tool
B6421E1-ND3G-5-50	05	Nickel	Delrin	50	9
B6421E1-ND3G-5A-50	05A	Nickel	Delrin	50	9
B6321A2-001-NT3G-5A-50 Front Mount	05A	Nickel	Teflon	50	2
B6421E1-ND3G-6-75	06	Nickel	Delrin	75	9
B6421E1-ND3G-6A-75	06A	Nickel	Delrin	75	3
B6421G1-ND3G-14-50	14	Nickel	Delrin	50	1 or 2
B6421A1-NT3G-16-75	16	Nickel	Teflon	75	3
B6421A3-NT3G-16A-75	16A	Nickel	Teflon	75	3
B6421A3-NT3G-18-75*	18	Nickel	Teflon	75	4
B6421A3-NT3G-19-75*	19	Nickel	Teflon	75	9

* Center contact .052" diameter, 30µ" Au, true 75 ohm.
Use .044 hex crimp or 12-indent crimp

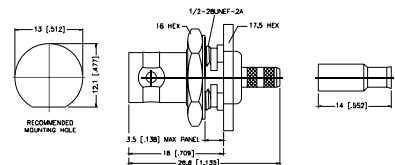
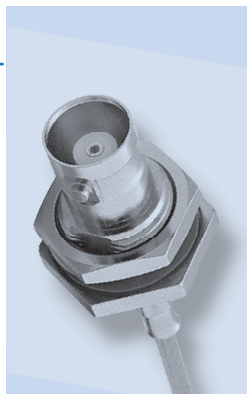

Assembly Instruction J - page 236

B6321A2-003-NT3G-5-50 Front Mount	05	Nickel	Teflon	50	1 or 2
B6321A2-005-NT3G-5A-50 Front Mount	05A	Nickel	Teflon	50	2

Remark: With teflon sleeve, Hex crimp size .178",
3.5 [.138] Max. panel thickness



B6321A2-003-NT3G-5-50, B6321A2-005-NT3G-5A-50

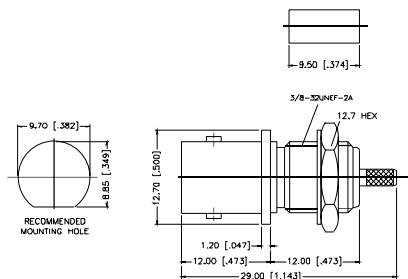

Assembly Instruction J - page 236

Bulkhead Solder Jack - Semi-Rigid Cable

P.N.	Cable Group	Pit.	Ins.	Imp.	Crimp Tool
B6481A1-N/3GT3G-10-50	10	Nickel/Gold	Teflon	50	N/A
B6481A1-N/3GT3G-11-50	11	Nickel/Gold	Teflon	50	N/A
B6381A1-N/3GT3G-11-50 Front Mount	11	Nickel/Gold	Teflon	50	N/A
B6381-N/3GT3G-11-75 Front Mount	11	Nickel/Gold	Teflon	75	N/A

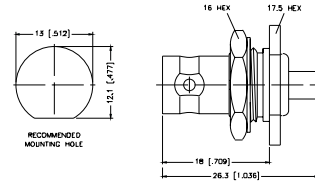

Assembly Instruction E - page 231

Bulkhead Isolated Crimp Jack - Standard Cable

P.N.	Cable Group	Pit.	Ins.	Imp.	Crimp Tool
Teflon/Captured					
B6721A1-NT3G-1-50	01	Nickel	Teflon	50	4
B6721A1-NT3G-1A-50	01A	Nickel	Teflon	50	4
B6721A1-NT3G-3-50	03	Nickel	Teflon	50	4
B6721A1-NT3G-3-75	03	Nickel	Teflon	75	4

Remark: 6.0 [0.236] Max. panel thickness

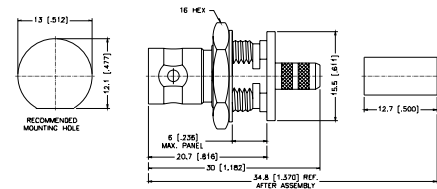
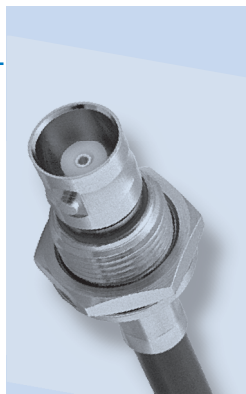

Assembly Instruction J - page 236

Panel Crimp Jack - Standard Cable

P.N.	Cable Group	Pit.	Ins.	Imp.	Crimp Tool
B6521A1-NT3G-1-50	01	Nickel	Teflon	50	4
B6521A1-ND3G-1A-50	01A	Nickel	Delrin	50	3 or 4
B6521A1-NT3G-3-50	03	Nickel	Teflon	50	4
B6521A1-NT3G-3-75	03	Nickel	Teflon	75	4

Remark: 5.0 [0.197] Max. panel thickness

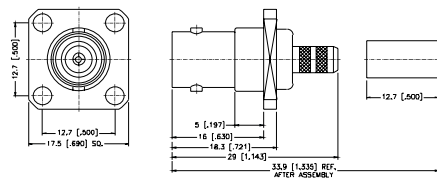
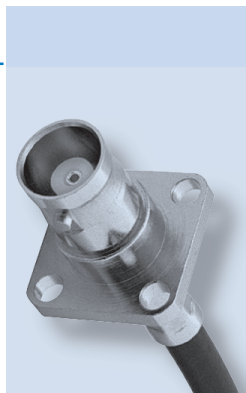

Assembly Instruction J - page 236

Panel Crimp and Solder Jack - Miniature Cable

P.N.	Cable Group	Pit.	Ins.	Imp.	Crimp Tool
B6521E1-NT3G-5-50	05	Nickel	Teflon	50	9
B6521F1-NT3G-5A-50	05A	Nickel	Teflon	50	9
B6521F1-ND3G-6-75	06	Nickel	Delrin	75	9

Remark: 5.0 [.197] Max. panel thickness

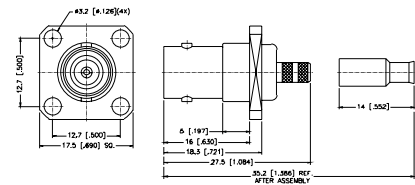
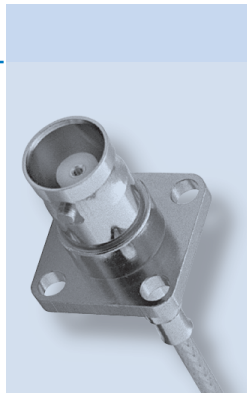

Assembly Instruction J - page 236

Panel Crimp and Solder Jack - Semi-Rigid Cable

P.N.	Cable Group	Pit.	Ins.	Imp.	Crimp Tool
B6581A1-N/3GT3G-10-50	10	Nickel/Gold	Teflon	50	N/A
B6581A1-N/3GT3G-11-50	11	Nickel/Gold	Teflon	50	N/A

Remark: 5.0 [.197] Max. panel thickness

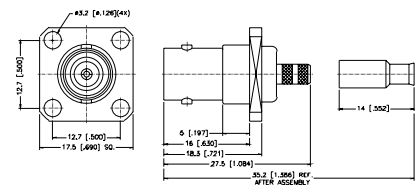
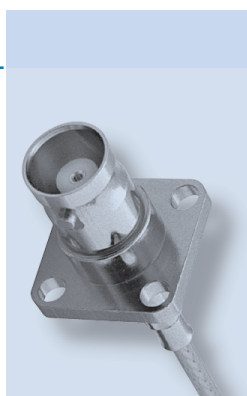

Assembly Instruction E - page 231

Straight Clamp Plug - Captive Contact - Standard Cable

P.N.	Cable Group	Pit.	Ins.	Imp.	Crimp Tool
B1141A1-ND3G-1-50	01	Nickel	Delrin	50	N/A
B1141A1-ND3G-3-50	03	Nickel	Delrin	50	N/A
B1141A1-ND3G-3-75	03	Nickel	Delrin	75	N/A
B1141C1-NT3G-5-50	05	Nickel	Teflon	50	N/A
B1141A2-NT3G-7A-50	07A	Nickel	Teflon	50	N/A
B1141A2-NT3G-7E-75	07E	Nickel	Teflon	75	N/A

Remark: Barrel O.D. = 12.5 mm

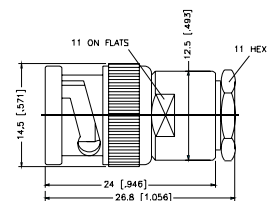
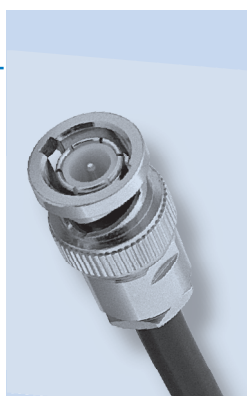

Assembly Instruction M - page 239

P.N.	Cable Group	Pit.	Ins.	Imp.	Crimp Tool
Brass Shell					
B1141C1-ND3G-1-50	01	Nickel	Delrin	50	N/A
B1141C1-ND3G-3-50	03	Nickel	Delrin	50	N/A
B1141C1-ND3G-3-75	03	Nickel	Delrin	75	N/A
Diecast Shell					
B1141D1-001-ND3G-1-50	01	Nickel	Delrin	50	N/A
B1141D1-ND3G-3-50	03	Nickel	Delrin	50	N/A

Remark: UG-88/U, UG-260/U

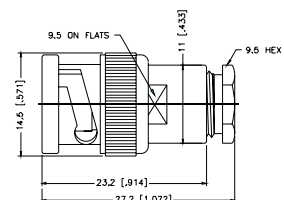

Assembly Instruction M - page 239

Right Angle Clamp Plug - Standard Cable

P.N.	Cable Group	Pit.	Ins.	Imp.	Crimp Tool
Brass Shell					
B1142E1-ND3G-1-50	01	Nickel	Delrin	50	N/A
B1142E1-ND3G-3-50	03	Nickel	Delrin	50	N/A
B1142E1-ND3G-3-75	03	Nickel	Delrin	75	N/A

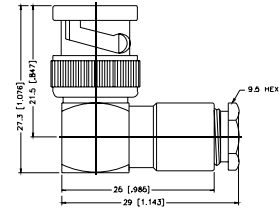
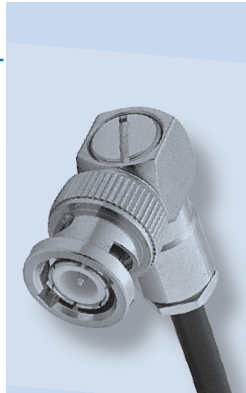

Assembly Instruction M - page 239

Straight Clamp Jack - Captive contact - Standard Cable

P.N.	Cable Group	Pit.	Ins.	Imp.	Crimp Tool
B6141A1-NT3G-1-50	01	Nickel	Teflon	50	N/A
B6141A1-NT3G-3-50	03	Nickel	Teflon	50	N/A
B6141A1-NT3G-3-75	03	Nickel	Teflon	75	N/A
B6141A2-NT3G-7A-50	07A	Nickel	Teflon	50	N/A

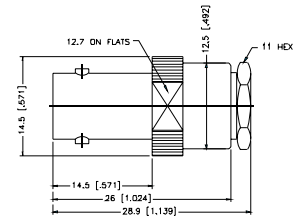
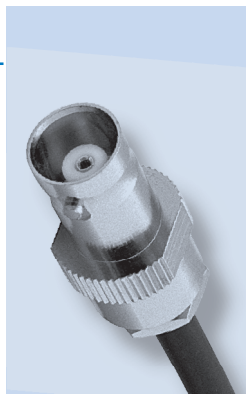

Assembly Instruction N - page 240

Bulkhead Clamp Jack - Captive Contact - Flexible Cable

P.N.	Cable Group	Pit.	Ins.	Imp.	Crimp Tool
B6441A2-NT3G-1-50	01	Nickel	Teflon	50	N/A

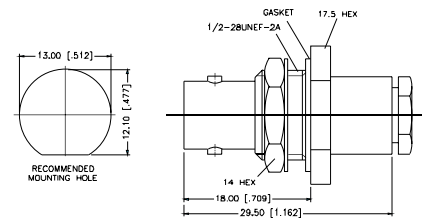

Assembly Instruction N - page 240

Twist-On Plug - Standard Cable

P.N.	Cable Group	Pit.	Ins.	Imp.	Crimp Tool
Brass Shell					
B1131A1-ND3G-1-50	01	Nickel	Delrin	50	N/A
B1131A1-ND3G-3-50	03	Nickel	Delrin	50	N/A
B1131A1-ND3G-3-75	03	Nickel	Delrin	75	N/A
B1131A1-ND3G-8-50	08	Nickel	Delrin	50	N/A

Remark: Only for solid center conductor cable

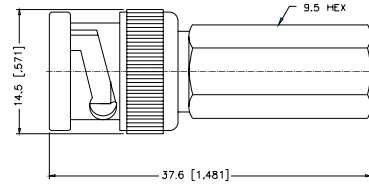
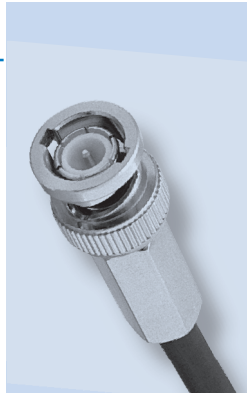

Assembly Instruction O - page 241

Twist-On Jack - Standard Cable

P.N.	Cable Group	Pit.	Ins.	Imp.	Crimp Tool
B6131A1-ND3G-1-50	01	Nickel	Delrin	50	N/A
B6131A1-ND3G-3-50	03	Nickel	Delrin	50	N/A

Remark: Only for solid center conductor cable

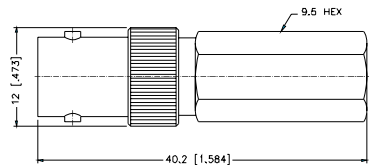
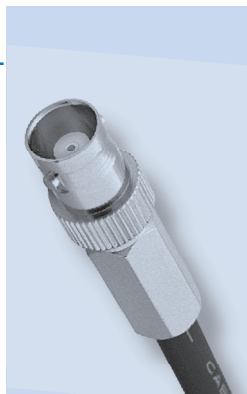

Assembly Instruction O - page 241

Wedge compression Plug - Standard Cable

P.N.	Cable Group	Pit.	Ins.	Imp.	Crimp Tool
Brass Shell					
B1141G1-ND3G-1-50	01	Nickel	Delrin	50	N/A
B1141G1-ND3G-3-50	03	Nickel	Delrin	50	N/A
B1141G1-ND3G-3-75	03	Nickel	Delrin	75	N/A

Remark: With wedge pin

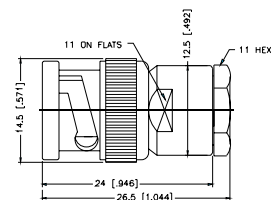

Assembly Instruction P - page 242

Wedge Compression Jack - Standard cable

P.N.	Cable Group	Pit.	Ins.	Imp.	Crimp Tool
B6141G1-NT3G-1-50	01	Nickel	Teflon	50	N/A
B6141G1-NT3G-3-50	03	Nickel	Teflon	50	N/A
B6141G1-NT3G-3-75	03	Nickel	Teflon	75	N/A

Remark: With wedge contact

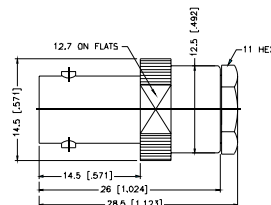
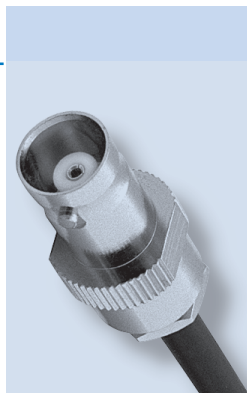

Assembly Instruction P - page 242

Bulkhead Receptacle Plug - Front Mount

P.N.	Cable Group	Pit.	Ins.	Imp.	Crimp Tool
Brass Shell					
B1351Q1-ND3G-50	N/A	Nickel	Delrin	50	N/A
B1351Q2-NT3G-75	N/A	Nickel	Teflon	75	N/A

Remark: 4.5 [.177] Max. panel thickness

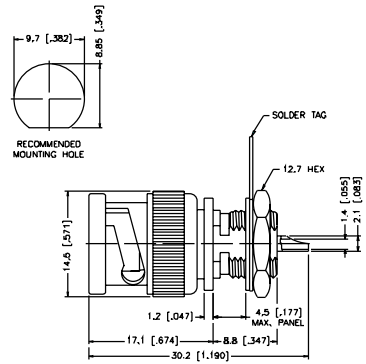
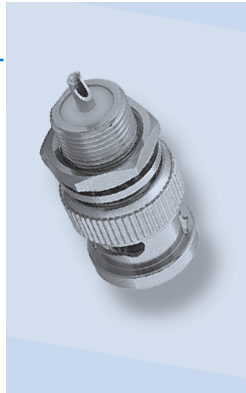

Bulkhead Receptacle Jack - Front Mount

P.N.	Cable Group	Pit.	Ins.	Imp.	Crimp Tool
L1 = 3.2 [.126] Max. panel thickness, L = 26.7 [1.05]					
B6351B1-ND3G-50	N/A	Nickel	Delrin	50	N/A
B6351B1-NT3G-50	N/A	Nickel	Teflon	50	N/A
B6351B1-ND3G-75	N/A	Nickel	Delrin	75	N/A
L1 = 6.5 [.256] Max. panel thickness, L = 30.0 [1.18]					
B6351B2-ND3G-50	N/A	Nickel	Delrin	50	N/A
B6351B2-ND3G-75	N/A	Nickel	Delrin	75	N/A

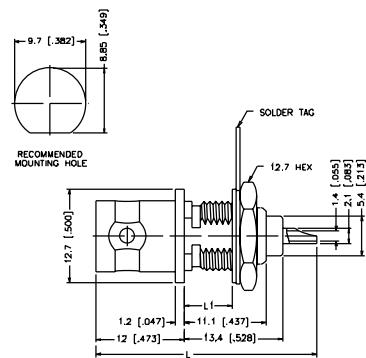
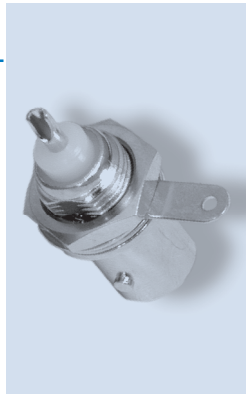

Bulkhead Receptacle Isolated Jack - Front Mount

P.N.	Cable Group	Pit.	Ins.	Imp.	Crimp Tool
B6651B1-NNYL3G-50	N/A	Nickel	ABS	50	N/A
B6651B1-NNYL3G-75	N/A	Nickel	ABS	75	N/A

Remark: 3.2 [.126] Max. panel thickness

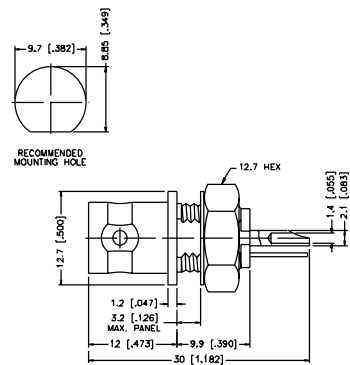

Bulkhead Receptacle Isolated Jack - Rear Mount

P.N.	Cable Group	Pit.	Ins.	Imp.	Crimp Tool
B675100-001-NT3G-50	N/A	Nickel	Teflon	50	N/A

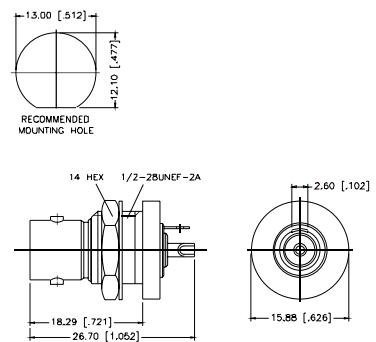
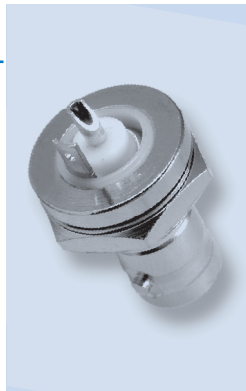

Bulkhead Receptacle - Push Fit

P.N.	Cable Group	Plt.	Ins.	Imp.	Crimp Tool
B6051A2-NT30G-50	N/A	Nickel	Teflon	50	N/A

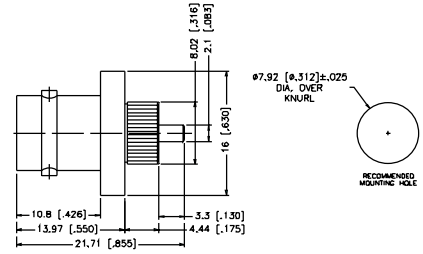
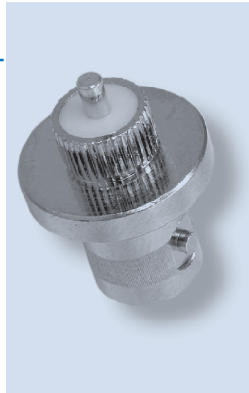

P.N.	Cable Group	Plt.	Ins.	Imp.	Crimp Tool
B6051A1-NT50G-50	N/A	Nickel	Teflon	50	N/A

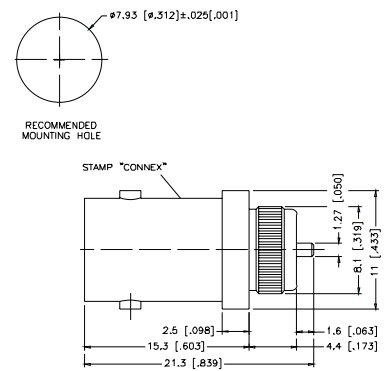

Panel Receptacle Jack

P.N.	Cable Group	Plt.	Ins.	Imp.	Crimp Tool
B6551A1-NT3G-50	N/A	Nickel	Teflon	50	N/A
B6551A1-NT3G-75	N/A	Nickel	Teflon	75	N/A
B6551A9-001-NT3G-50 Flush Rear 4-40 Screws	N/A	Nickel	Teflon	50	N/A

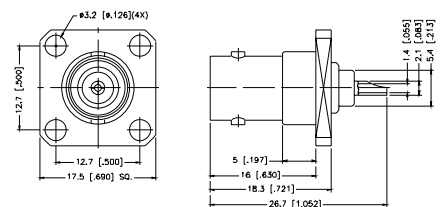
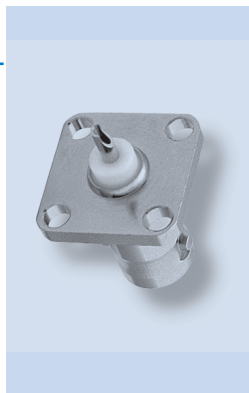

Panel Receptacle Plug

P.N.	Cable Group	Pit.	Ins.	Imp.	Crimp Tool
B1551A1-NT3G-50	N/A	Nickel	Teflon	50	N/A

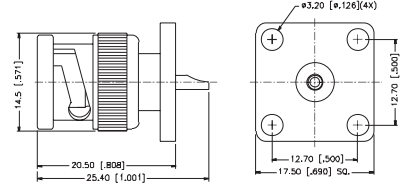
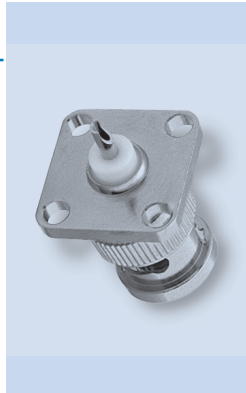

Panel Receptacle Jack - Exposed TFE Type

P.N.	Cable Group	Pit.	Ins.	Imp.	Crimp Tool
B6551E1-002-NT30G-50	N/A	Nickel	Teflon	50	N/A
B6551E1-002-ST30GA-50	N/A	Silver	Teflon	50	N/A

Note: Contact Amphenol for other lengths availability

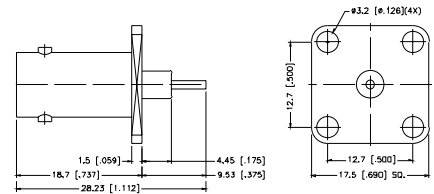
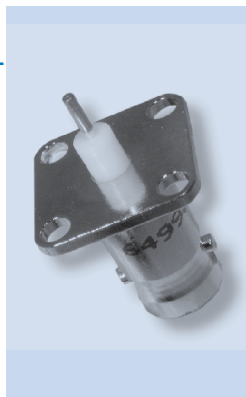

Panel Receptacle - Exposed Teflon - Gasket Seal

P.N.	Cable Group	Pit.	Ins.	Imp.	Crimp Tool
B6551E1-001-NT3G-50	N/A	Nickel	Teflon	50	N/A

Note: Contact Amphenol for other lengths availability

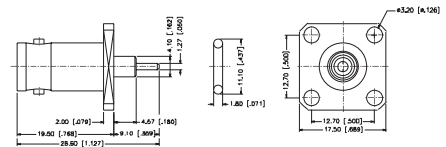
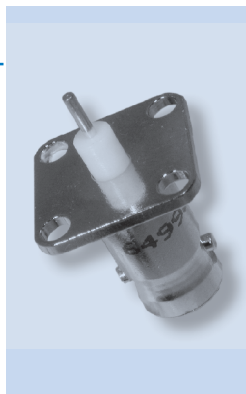

Straight P.C. Board Mount Jack - Four Legs

P.N.	Cable Group	Plt.	Ins.	Imp.	Crimp Tool
B6251C1-NT3G-50	N/A	Nickel	Teflon	50	N/A
B6251C1-NT3G-75	N/A	Nickel	Teflon	75	N/A

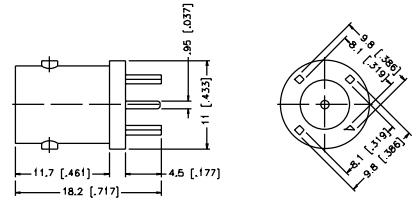
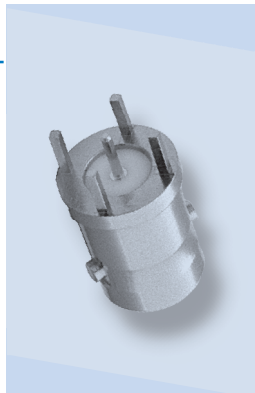

P.N.	Cable Group	Plt.	Ins.	Imp.	Crimp Tool
B6251D1-NPB3G-50	N/A	Nickel	PBT Polyester	50	N/A
B6251D1-NPB3G-75	N/A	Nickel	PBT Polyester	75	N/A

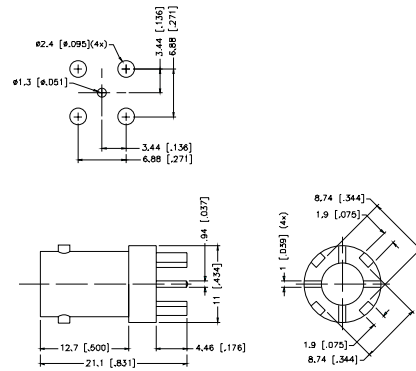
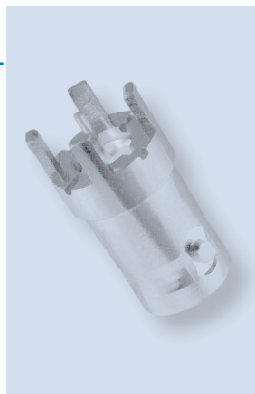

P.N.	Cable Group	Plt.	Ins.	Imp.	Crimp Tool
B6251C1-003-NT3G-50	N/A	Nickel	Teflon	50	N/A
B6251C1-004-NT3G-50 Waterproof	N/A	Nickel	Teflon	50	N/A

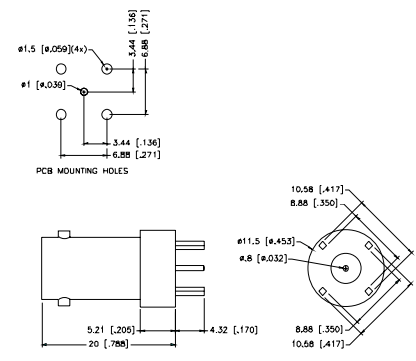
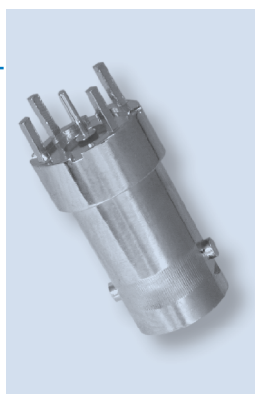

P.N.	Cable Group	Plt.	Ins.	Imp.	Crimp Tool
B625100-009-NT3G-50	N/A	Nickel	Teflon	50	N/A
B625100-009-NT3G-75	N/A	Nickel	Teflon	75	N/A

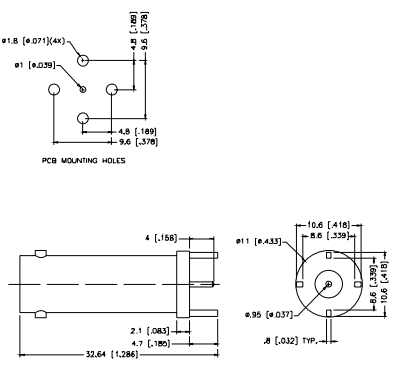
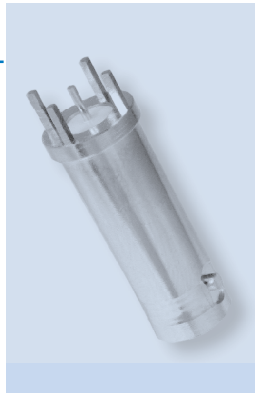

Straight P.C. Board Mount Jack - Three Legs

P.N.	Cable Group	Pit.	Ins.	Imp.	Crimp Tool
B6251E1-NT3G-50	N/A	Nickel	Teflon	50	N/A

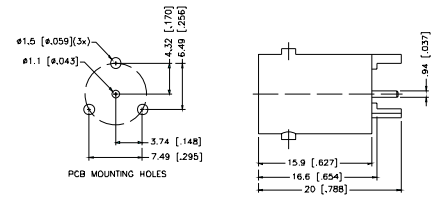
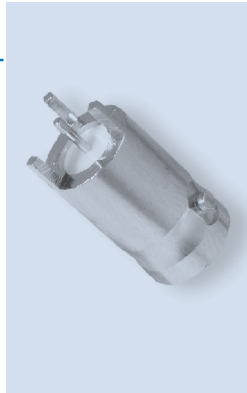

Straight P.C. Board Mount Jack - Four Legs

P.N.	Cable Group	Pit.	Ins.	Imp.	Crimp Tool
B6251C1-005-NT30G-75T	N/A	Nickel	Teflon	75	N/A

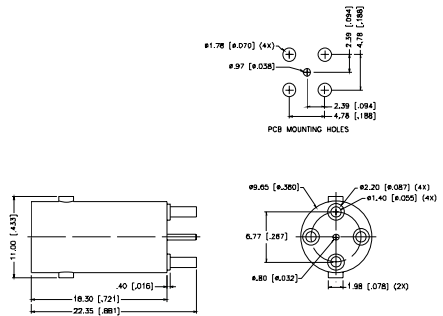
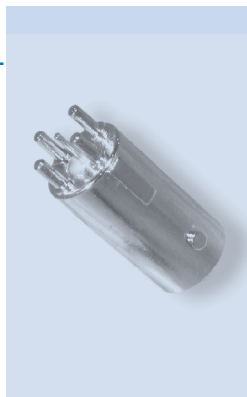

P.N.	Cable Group	Pit.	Ins.	Imp.	Crimp Tool
B6251F1-NT3G-50	N/A	Nickel	Teflon	50	N/A
B6251F1-NT3G-75	N/A	Nickel	Teflon	75	N/A

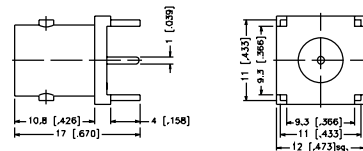
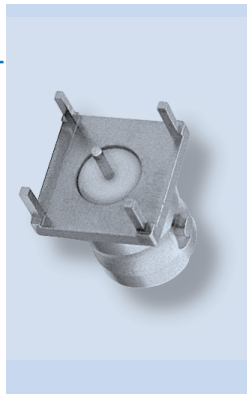

P.N.	Cable Group	Pit.	Ins.	Imp.	Crimp Tool
B625100-008-NT3G-50	N/A	Nickel	Teflon	50	N/A
B625100-005-NT3G-75	N/A	Nickel	Teflon	75	N/A

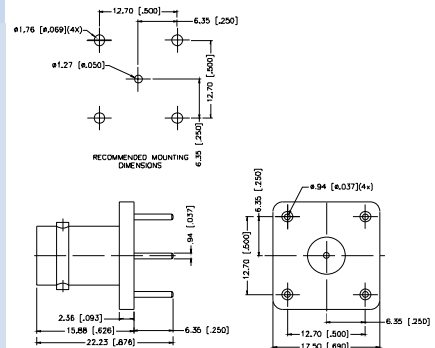
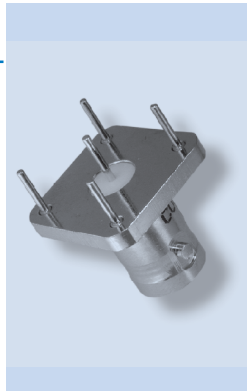

Straight P.C. Board Edge mount Jack - End Launch

P.N.	Cable Group	Plt.	Ins.	Imp.	Crimp Tool
B6251Q1-001-NT3G-50	N/A	Nickel	Teflon	50	N/A
B6251Q1-001-NT3G-75	N/A	Nickel	Teflon	75	N/A

Square Flange

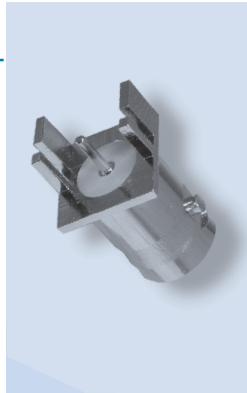

B6251Q1-001-NT3G-50

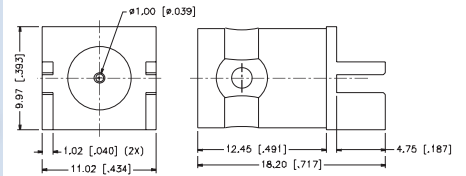

B625100-006-NT3G-50	N/A	Nickel	Teflon	50	N/A
B625100-006-NT3G-75	N/A	Nickel	Teflon	75	N/A

Round Flange

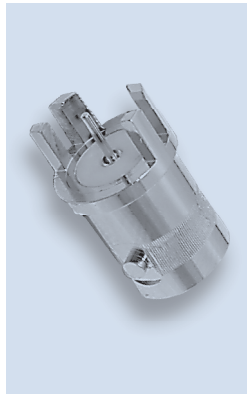

B625100-006-NT3G-50

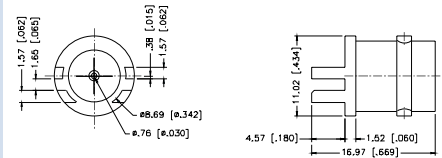

Bulkhead Vertical P.C. Board Receptacle - End Launch

P.N.	Cable Group	Plt.	Ins.	Imp.	Crimp Tool
B6351B1-004-NT3G-50	N/A	Nickel	Teflon	50	N/A

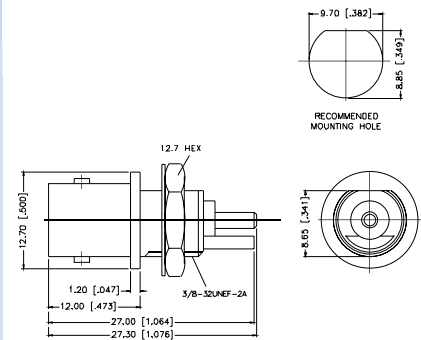

Commercial Straight P.C. Board Mount Jack

P.N.	Cable Group	Pit.	Ins.	Imp.	Crimp Tool
White Housing					
B6251G1-NPP3G-50	N/A	Nickel	Polypropylene	50	N/A
B6251G1-NPP3G-75T	N/A	Nickel	Polypropylene	75	N/A
Black Housing					
B6251G2-NPP3G-50	N/A	Nickel	Polypropylene	50	N/A
B6251G2-NPP3G-75T	N/A	Nickel	Polypropylene	75	N/A

Remark: Add L to part number for Locking Legs

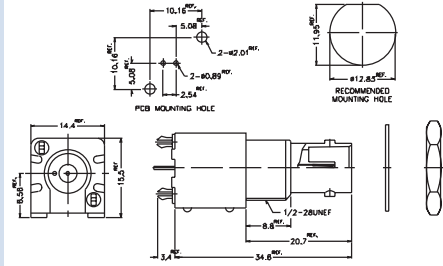
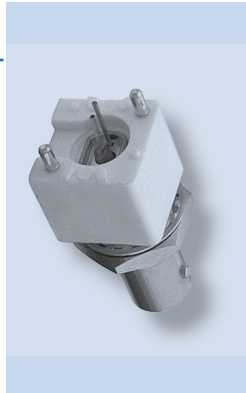

Commercial Straight P.C. Board Mount Jack - Metal Body

P.N.	Cable Group	Pit.	Ins.	Imp.	Crimp Tool
Diecast					
B6251G3-NPP3G-50	N/A	Nickel	Polypropylene	50	N/A
B6251G3-NPP3G-75T	N/A	Nickel	Polypropylene	75	N/A

Note: Connectors are shipped with lock nut and washer

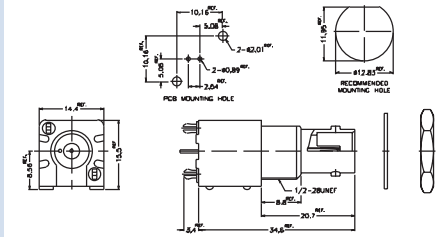
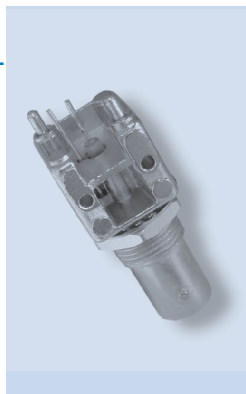

Commercial Right Angle P.C. Board Mount Jack

P.N.	Cable Group	Pit.	Ins.	Imp.	Crimp Tool
High Profile, 15.88 [.625] White					
B6252H5-NPP3G-50	N/A	Nickel	Polypropylene	50	N/A
B6252H5-NPP3G-75T	N/A	Nickel	Polypropylene	75	N/A
High Profile, 15.88 [.625] Black					
B6252H6-NPP3G-50	N/A	Nickel	Polypropylene	50	N/A
B6252H6-NPP3G-75T	N/A	Nickel	Polypropylene	75	N/A
Low Profile, 13.1 [.516] White					
B6252H7-NPP3G-50	N/A	Nickel	Polypropylene	50	N/A
B6252H7-NPP3G-75T	N/A	Nickel	Polypropylene	75	N/A
Low Profile, 13.1 [.516] Black					
B6252H8-NPP3G-50	N/A	Nickel	Polypropylene	50	N/A
B6252H8-NPP3G-75T	N/A	Nickel	Polypropylene	75	N/A

Note: Connectors are shipped with lock nut and washer

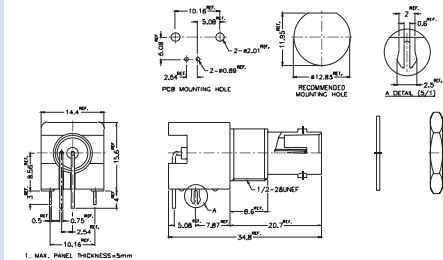
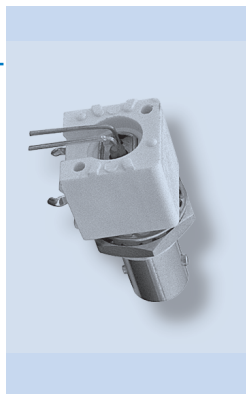

Commercial Right Angle P.C. Board Mount Jack - Metal Body

P.N.	Cable Group	Pit.	Ins.	Imp.	Crimp Tool
Diecast					
High Profile, 15.88 [.625]					
B6252HA-NPP3G-50	N/A	Nickel	Polypropylene	50	N/A
B6252HA-NPP3G-75T	N/A	Nickel	Polypropylene	75	N/A
Low Profile, 13.1 [.516]					
B6252HB-NPP3G-50	N/A	Nickel	Polypropylene	50	N/A
B6252HB-NPP3G-75T	N/A	Nickel	Polypropylene	75	N/A
UL approved UL no. E161813					
High Profile, 15.88 [.625]					
B6252HC-NPP3G-50	N/A	Nickel	Polypropylene	50	N/A
B6252HC-NPP3G-75T	N/A	Nickel	Polypropylene	75	N/A
with fork legs					
Low Profile, 13.1 [.516]					
B6252HD-NPP3G-50	N/A	Nickel	Polypropylene	50	N/A
B6252HD-NPP3G-75T	N/A	Nickel	Polypropylene	75	N/A
with fork legs					

Note: Connectors are shipped with lock nut and washer

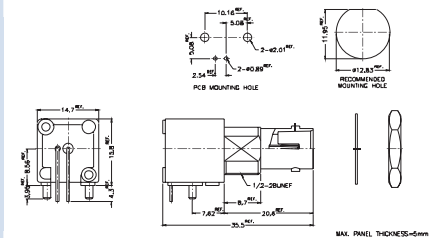
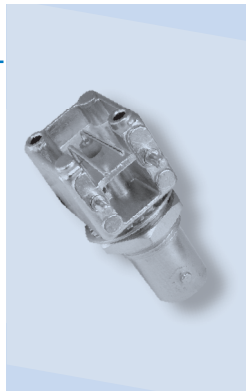

Dual port PCB Mount Receptacle Hook

P.N.	Cable Group	Pit.	Ins.	Imp.	Crimp Tool
B705000-NPB3G-75 Plastic body	N/A	Nickel	Polypropylene	75	N/A
B705001-NPB3G-75 Metal body	N/A	Nickel	Polypropylene	75	N/A

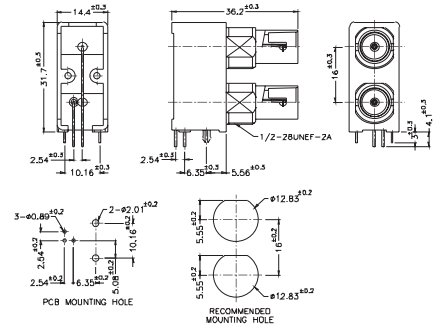
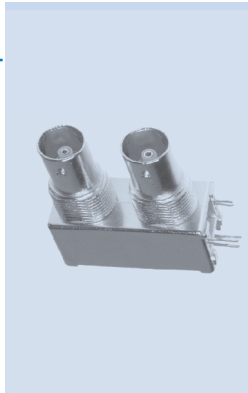

Press-Fit PC Board Receptacle Jack

P.N.	Cable Group	Pit.	Ins.	Imp.	Crimp Tool
B6251PF-NT10G-50	N/A	Nickel	Teflon	50	N/A

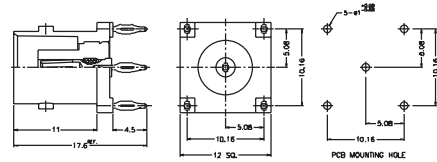
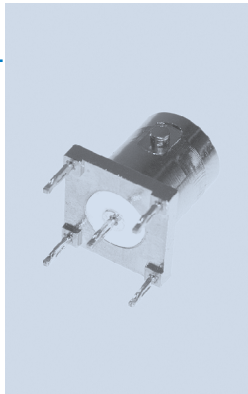

Straight P.C. Board Receptacle Jack

P.N.	Cable Group	Pit.	Ins.	Imp.	Crimp Tool
MNB6251A1-001-NT30G-75	N/A	Nickel	Teflon	75	N/A
MNB6251A1-001-3GT30G-75	N/A	Gold	Teflon	75	N/A

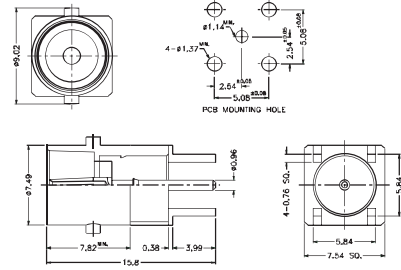
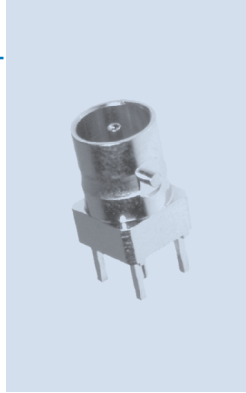

Right Angle P.C. Board Receptacle Jack

P.N.	Cable Group	Pit.	Ins.	Imp.	Crimp Tool
MNB6252A1-001-NT30G-75	N/A	Nickel	Teflon	75	N/A

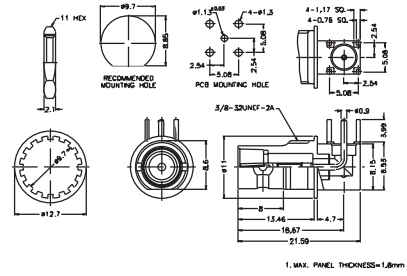
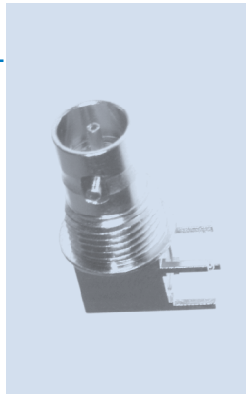

Straight Crimp Plug

P.N.	Cable Group	Pit.	Ins.	Imp.	Crimp Tool
MNB1121A1-001-NT30G-75	19	Nickel	Teflon	75	3
MNB1121A1-NT30G-8A-75	08A	Nickel	Teflon	75	7.06 Hex
MNB1121A1-NT30G-16-75	16	Nickel	Teflon	75	3
MNB1121A1-NT30G-16A-75	16A	Nickel	Teflon	75	3
MNB1121C1-NT30G-18-75	18	Nickel	Teflon	75	4
MNB1121E1-NT30G-6-75	06	Nickel	Teflon	75	7

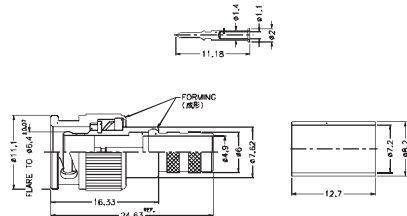
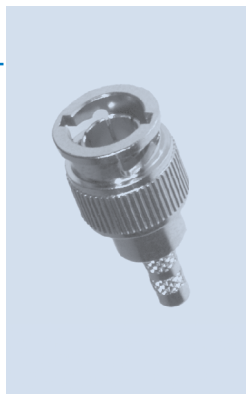

Assembly Instruction J - page 236

Bulkhead Crimp Jack-Isolated

P.N.	Cable Group	Pit.	Ins.	Imp.	Crimp Tool
MNB6721C1-001-NT30G-75	19	Nickel	Teflon	75	3

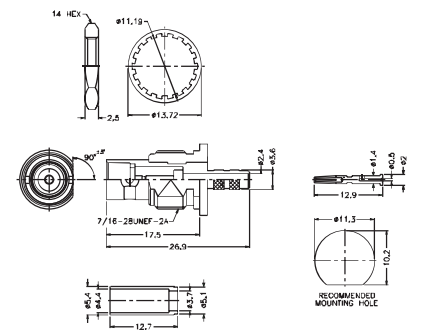

Assembly Instruction J - page 236-

MAX. PANEL THICKNESS=6mm

Jack-to-Jack Bulkhead Adapter

P.N.	Cable Group	Pit.	Ins.	Imp.	Crimp Tool
B7471A1-ND3G-50	N/A	Nickel	Delrin	50	N/A
B7471A1-ND3G-75	N/A	Nickel	Delrin	75	N/A

Remark: 8.0 mm [.315] Max. panel thickness, M55339/13-00492

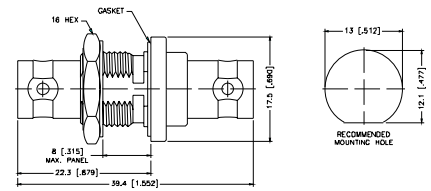
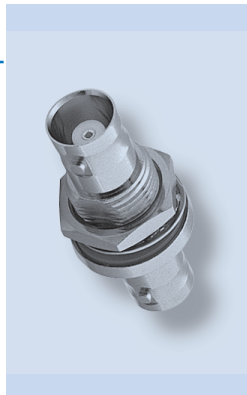

P.N.	Cable Group	Pit.	Ins.	Imp.	Crimp Tool
B7471A2-ND3G-50	N/A	Nickel	Delrin	50	N/A
B7471A2-ND3G-75	N/A	Nickel	Delrin	75	N/A

Remark: 7.0 mm [.276] Max. panel thickness, UG-492A

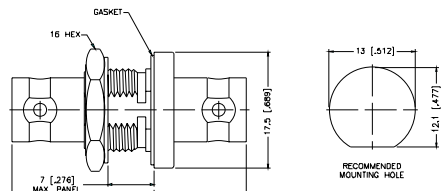
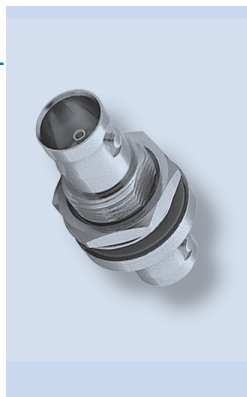

P.N.	Cable Group	Pit.	Ins.	Imp.	Crimp Tool
B7471B1-ND3G-50	N/A	Nickel	Delrin	50	N/A
B7471B1-ND3G-75	N/A	Nickel	Delrin	75	N/A

Remark: Without gasket, 5.5 mm [.217] Max. panel thickness

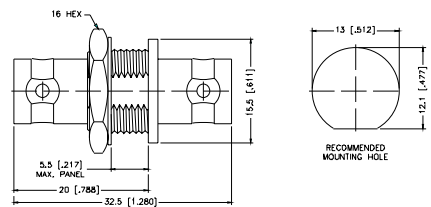
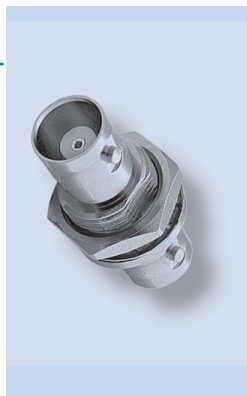

Jack-to-Plug Bulkhead Adapter - Push-On

P.N.	Cable Group	Pit.	Ins.	Imp.	Crimp Tool
B5071A1-NT3G-75	N/A	Nickel	Teflon	75	N/A

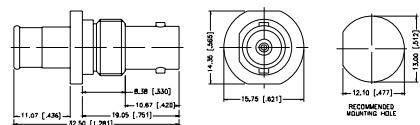

Jack-to-Jack Bulkhead - Isolated Adapter

P.N.	Cable Group	Pit.	Ins.	Imp.	Crimp Tool
B7771B1-ND3G-50	N/A	Nickel	Delrin	50	N/A
B7771B1-ND3G-75	N/A	Nickel	Delrin	75	N/A

Remark: With Isolated Bushing,
4.5 mm [.177] Max. panel thickness

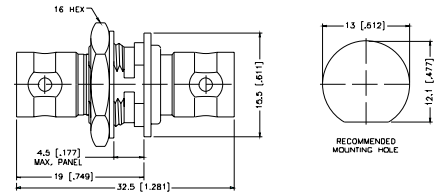
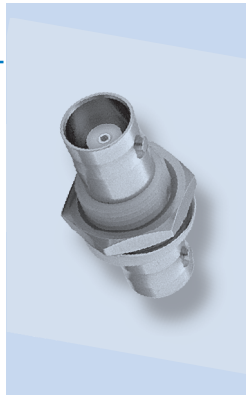

P.N.	Cable Group	Pit.	Ins.	Imp.	Crimp Tool
B7771B3-ND3G-50	N/A	Nickel	Delrin	50	N/A
B7771B3-ND3G-75	N/A	Nickel	Delrin	75	N/A

Remark: 5.5 mm [.217] Max. panel thickness

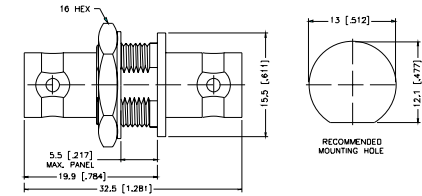
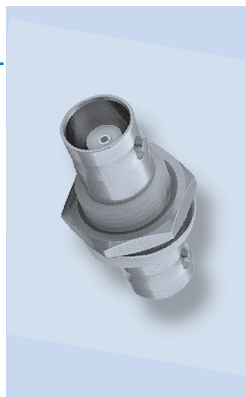

Jack-to-Jack Adapter

P.N.	Cable Group	Pit.	Ins.	Imp.	Crimp Tool
B7071A1-ND3G-50	N/A	Nickel	Delrin	50	N/A
B7071A1-ND3G-75	N/A	Nickel	Delrin	75	N/A

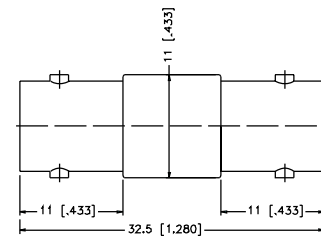

Plug-to-Plug Adapter

P.N.	Cable Group	Pit.	Ins.	Imp.	Crimp Tool
Brass Shell					
B2071A2-ND3G-50	N/A	Nickel	Delrin	50	N/A
B2071A2-ND3G-75	N/A	Nickel	Delrin	75	N/A
Diecast Shell					
B2071B2-002-ND3G-50	N/A	Nickel	Delrin	50	N/A
B2071B2-002-ND3G-75	N/A	Nickel	Delrin	75	N/A

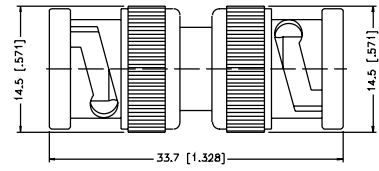

Right Angle Adapter - Plug-to-Jack

P.N.	Cable Group	Pit.	Ins.	Imp.	Crimp Tool
Brass Shell					
B5072A1-ND3G-50	N/A	Nickel	Delrin	50	N/A
B5072A1-ND3G-75	N/A	Nickel	Delrin	75	N/A
Diecast Shell					
B5072B1-001-ND3G-50	N/A	Nickel	Delrin	50	N/A
B5072B1-001-ND3G-75	N/A	Nickel	Delrin	75	N/A

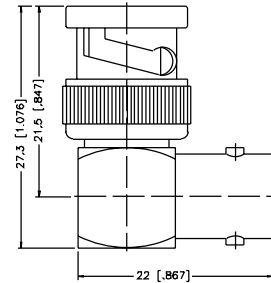
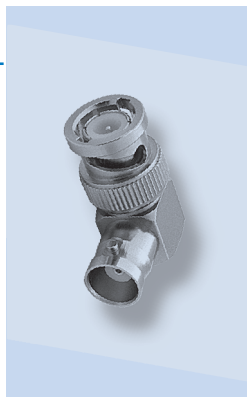

Tee Adapter - Jack-to-Jack-to-Jack

P.N.	Cable Group	Pit.	Ins.	Imp.	Crimp Tool
B8073A1-ND3G-50	N/A	Nickel	Delrin	50	N/A
B8073A1-ND3G-75	N/A	Nickel	Delrin	75	N/A

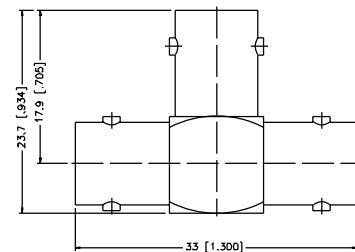
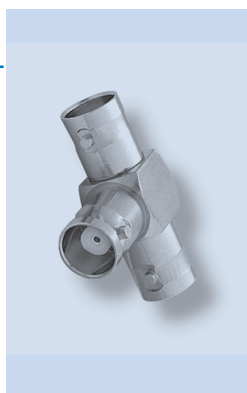

Tee Adapter - Jack-to-Plug-to-Jack

P.N.	Cable Group	Pit.	Ins.	Imp.	Crimp Tool
B9073D1-ND3G-50	N/A	Nickel	Delrin	50	N/A
B9073D1-ND3G-75	N/A	Nickel	Delrin	75	N/A

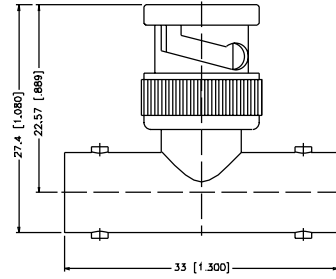
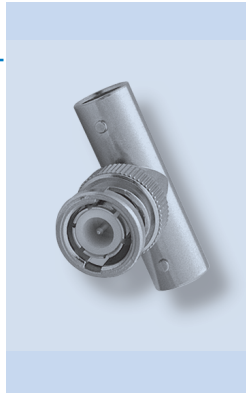

Tee Adapter - Jack-to-Jack-to-Plug

P.N.	Cable Group	Pit.	Ins.	Imp.	Crimp Tool
OS-7078-NDG	N/A	Nickel	Delrin	50	N/A
OS-7078-NT3G	N/A	Nickel	Teflon	50	N/A

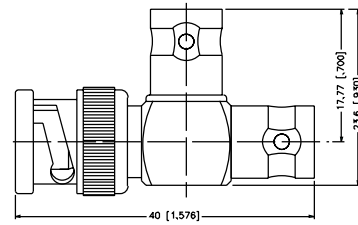
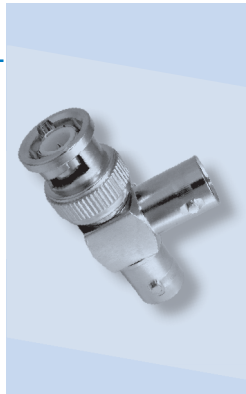

Terminator Plug

P.N.	Cable Group	Pit.	Ins.	Imp.	Crimp Tool
B1004A1-ND3G-50R-0.05-0.5W	N/A	Nickel	Delrin	50	N/A
B1004A1-NT3G-50R-0.5W	N/A	Nickel	Teflon	50	N/A
B1004A1-ND3G-75R-0.05-1W	N/A	Nickel	Delrin	75	N/A
B1004A1-NT3G-75R-0.05-1W	N/A	Nickel	Teflon	75	N/A
B1004A1-ND3G-93R-0.05-1W	N/A	Nickel	Delrin	93	N/A
B1004A1-NT3G-93R-0.05-1W	N/A	Nickel	Teflon	93	N/A
B1004A3-NT3G-50R High Performance	N/A	Nickel	Teflon	50	N/A
B1004A3-NT3G-75R-0.01-0.5W High Performance	N/A	Nickel	Teflon	75	N/A

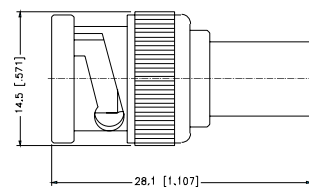
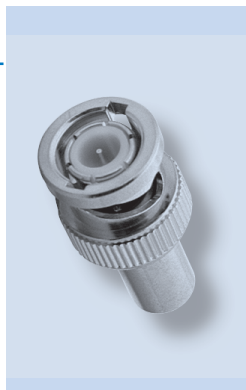

Terminator Jack

P.N.	Cable Group	Pit.	Ins.	Imp.	Crimp Tool
B6004A1-NT3G-50R-0.05-1W	N/A	Nickel	Teflon	50	N/A
B6004A1-NT3G-75R-0.05-1W	N/A	Nickel	Teflon	75	N/A
B6004A1-001-ND3G	N/A	Nickel	Delrin	500	N/A

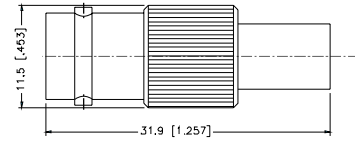
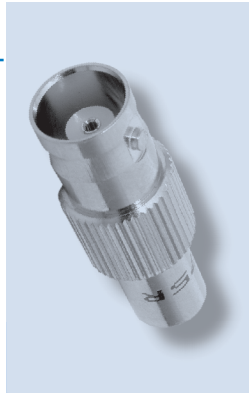

Male Cap & Chain

P.N.	Cable Group	Pit.	Ins.	Imp.	Crimp Tool
B1005A1-N With Chain Remark: Chain length 100 mm	N/A	Nickel	N/A	N/A	N/A
B1005A1-001-N No Chain	N/A	Nickel	N/A	N/A	N/A

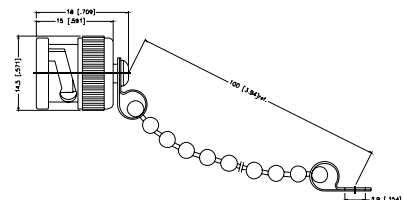

Male Shorting Cap

P.N.	Cable Group	Pit.	Ins.	Imp.	Crimp Tool
B1007A1-NT3G No Chain	N/A	Nickel	Teflon	N/A	N/A
B1007A2-NT3G With Chain	N/A	Nickel	Teflon	N/A	N/A

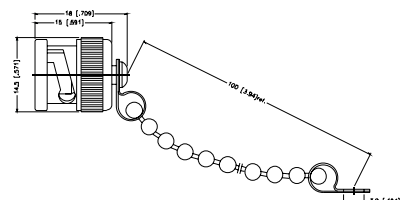

X-ON Electronics

Largest Supplier of Electrical and Electronic Components

Click to view similar products for [RF Connectors / Coaxial Connectors](#) category:

Click to view products by [Amphenol](#) manufacturer:

Other Similar products are found below :

[R125315120](#) [8915-1511-000](#) [89674-0827](#) [5916-1103-603](#) [0106-001-000](#) [6-0001-3](#) [6001-7071-019](#) [6002-7051-003](#) [6002-7551-202](#) [6059674-1](#) [619550-1](#) [630059-000](#) [M39012/25-0021](#) [M39012/79-3008](#) [M39030/3-01N](#) [M39030/3-03N](#) [M3933/25-29N](#) [M3933/25-36N](#) [6500-7071-046](#) [6501-1071-002](#) [M83723/72W24576](#) [M83723/72W2457N](#) [6769](#) [CX050L2AQ](#) [7002-1541-010](#) [7002-1572-002](#) [7003-1572-002](#) [7004-1512-000](#) [7009-1511-004](#) [7010-1511-000](#) [7029-1511-060](#) [7101-1541-010](#) [7101-1571-002](#) [7105-1521-002](#) [7145-1521-002](#) [7209-1511-011](#) [7210-1511-012](#) [7210-1511-015](#) [7210-1511-019](#) [7210-1511-040](#) [7225-1512-050](#) [7242-1511-000](#) [73137-5015](#) [73251-0111](#) [73251-0672](#) [73276-1501](#) [73366-0013](#) [73404-2300](#) [73413-6080](#) [734151610](#)