

### Description

Developed in the late 1940's, the BNC is a miniature version of the Type C. BNC stands for Bayonet Neill Concelman and is available in 50 Ohm and 75 Ohm impedance versions.

The BNC product line is a miniature quick connect / disconnect RF connector. It features two bayonet lugs on the female connector; mating is achieved with only a quarter turn of the coupling nut.

Primary Applications - Ideally suited for cable termination for miniature to subminiature coaxial cable (RG-58, 59, to RG-179, RG-316, etc.)

### Features/Benefits

- Bayonet coupling mechanism provides quick mating and unmating.
- 50 and 75 ohm impedance designs allow customers to match impedance to system requirements.
- 50 and 75 ohm connectors are intermateable to ensure nondestructive mating.
- Three grades of connectors are available for military, industrial and commercial applications

### Applications

- Antennas
- Automotive (GPS)
- Base Stations
- Broadcast (75 ohm)
- Cable Assemblies
- Cable Modems
- Components
- Computers/LANs
- Instrumentation
- Network Analyzers
- Oscilloscopes
- Medical Equipment
- Mil-Aerospace
- Networks
- Radios
- Satcom
- Surge Protection
- Telecom.

**Specifications**

**Electrical**

Impedance	50 ohm	75 ohm
Frequency Range	0-4 GHz	0-1 GHz
Working Voltage	500 Volts rms.	500 Volts rms.
Dielectric Withstanding Voltage	1500 Volts rms.	1500 Volts rms.
VSWR	1.3 max. 0-4 GHz	1.05+0.1f(GHz) DC to 1 GHz
Contact Resistance	Center contact 1.5 milliohm Outer contact 1.0 milliohm	Center contact 1.5 milliohm Outer contact 1.0 milliohm

**Material**

Center Contact male	Brass, Gold or Silver plated
Center Contact female	Phosphor Bronze (nominal) or Beryllium Copper, Gold or Silver plated
Metal parts	Brass, nickel plated
Insulators	Teflon, Delrin, PBT polyester
Clamp gaskets	Silicone rubber, Synthetic rubber
Crimp ferrule	Annealed copper, nickel plated

**Plug**

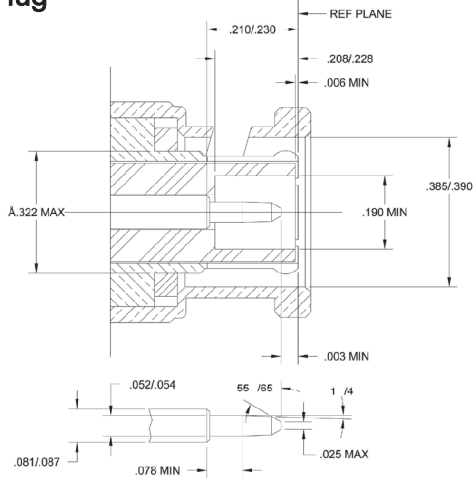

**Jack**

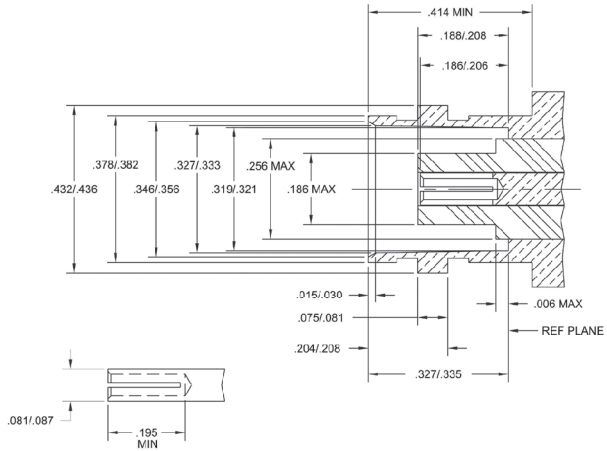

**Straight Crimp Plug - Single Crimp**

P.N.	Cable Group	Pit.	Ins.	Imp.	Crimp Tool
B1111L1-001-ND3G-01-50	01	Nickel	Delrin	50	5
B1111L1-001-ND3G-03-50	03	Nickel	Delrin	50	5

Remark: Only for Solid Center Conductor Cable

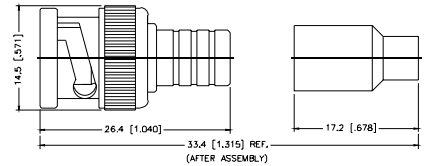
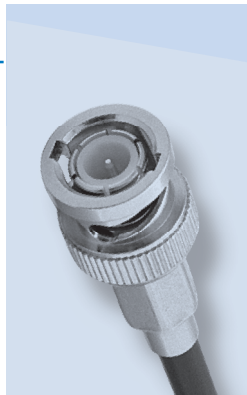

Assembly Instruction J - page 236

**Straight Crimp Plug - Captive Contact - Standard Cable**

P.N.	Cable Group	Pit.	Ins.	Imp.	Crimp Tool
B1121A1-NT3G-1-50	01	Nickel	Teflon	50	3 or 4
B1121A1-ND3G-1-50	01	Nickel	Delrin	50	3 or 4
B1121BA-001-ND3G-1A-50	01A	Nickel	Delrin	50	3 or 4
B1121AA-NT3G-1B-50	01B	Nickel	Teflon	50	3 or 4
B1121A1-ND3G-3-50	03	Nickel	Delrin	50	4
B1121A1-ND3G-3-75	03	Nickel	Delrin	75	4
B1121A9-NT3G-3-75*	03	Nickel	Teflon	75	7
B1121A1-ND3G-3A-75	03A	Nickel	Delrin	75	4
B1121A9-009-NT30G-3A-75*	03A	Nickel	Teflon	75	4
B1121A6-NT3G-7-50	07	Nickel	Teflon	50	4 + 6
B1121A6-NT3G-7A-50	07A	Nickel	Teflon	50	4 + 6
B1121A1-ND3G-7B-50	07B	Nickel	Delrin	50	4
B1121A6-NT3G-7C-50	07C	Nickel	Teflon	50	6
B1121A2-NT3G-7D-50	07D	Nickel	Teflon	50	4 + 6
B1121A6-NT3G-7E-75	07E	Nickel	Teflon	75	2 + 6
B1121A6-NT3G-7F-75	07F	Nickel	Teflon	75	2 + 6
B1121A1-ND3G-8-75	08	Nickel	Delrin	75	5
B1121CA-002-ND3G-8A-75	08A	Nickel	Delrin	75	5
B1121A9-NT15G-8A-75*	08A	Nickel	Teflon	75	2 + 5
B1121A9-NT15G-8B-75*	08B	Nickel	Teflon	75	5
B1121A1-ND3G-15-75	15	Nickel	Delrin	75	5
B1121A1-NT3G-15-75*	15	Nickel	Teflon	75	5
B1121C1-ND3G-15A-75	15A	Nickel	Delrin	75	5
B1121A9-003-NT3G-75	16	Nickel	Teflon	75	.180 hex
B1121A9-003-NT3G-75	16A	Nickel	Teflon	75	.180 hex
B1121A9-NT15G-18-75*	18	Nickel	Teflon	75	2 + 4
B1121A9-NT15G-19-75*	19	Nickel	Teflon	75	9
B1121A1-NT3G-22-75	22	Nickel	Teflon	75	.180 hex
<b>Diecast Shell</b>					
B1121BA-001-ND3G-1-50	01	Nickel	Delrin	50	3 or 4
B1121B1-ND3G-3-50	03	Nickel	Delrin	50	4
B1121B1-ND3G-3-75	03	Nickel	Delrin	75	4

\* Center contact .053" diameter, 30 μ" Au.  
True 75 ohm. Use .044 hex or 12-indent crimp

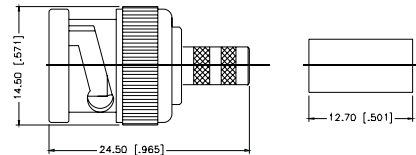
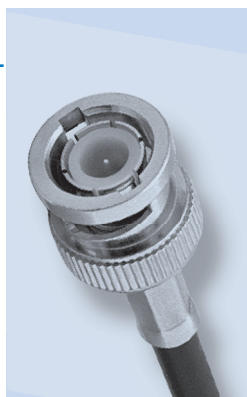

Assembly Instruction J - page 236

**Straight Crimp Plug - Pin-in-Pin - Miniature Cable**

P.N.	Cable Group	Pit.	Ins.	Imp.	Crimp Tool
<b>Brass Shell</b>					
B1121G1-ND3G-5-50	05	Nickel	Delrin	50	2
B1121G1-ND3G-6-75	06	Nickel	Delrin	75	2
<b>Diecast Shell</b>					
B1121H1-001-ND3G-5-50	05	Nickel	Delrin	50	1 or 2
B1121H1-001-ND3G-6-75	06	Nickel	Delrin	75	2

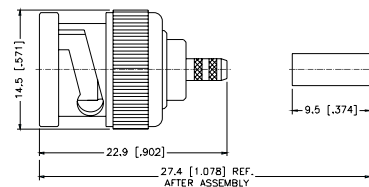
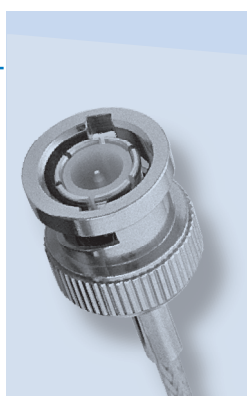

Assembly Instruction J - page 236

**Straight Crimp Plug - Miniature Cable**

P.N.	Cable Group	Pit.	Ins.	Imp.	Crimp Tool
<b>Brass Shell</b>					
B1121E9-002-NTPX3G-6-75	06	Nickel	TPX	75	3
<b>Diecast Shell</b>					
B1121F9-003-NTPX3G-6-75	06	Nickel	TPX	75	3
Remark: TPX Insulator/75 ohm AVAILABLE ONLY					

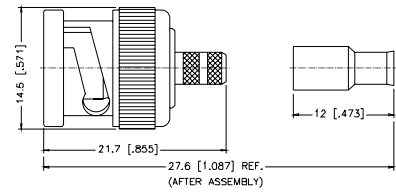
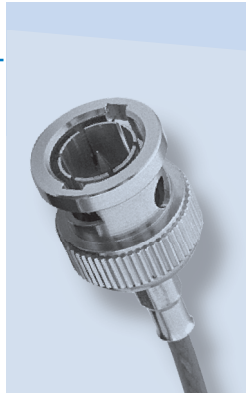

Assembly Instruction K - page 237

**Straight Crimp Plug - Captive Contact - Plenum Cable**

P.N.	Cable Group	Pit.	Ins.	Imp.	Crimp Tool
B1121CA-001-ND3G-4A-75	04A	Nickel	Delrin	75	4

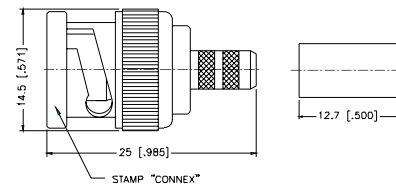
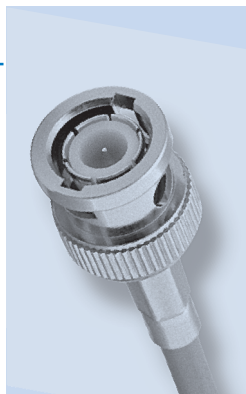

Assembly Instruction J - page 236

**Straight Crimp Plug - Captive Contact - Miniature Cable**

P.N.	Cable Group	Pit.	Ins.	Imp.	Crimp Tool
<b>Brass Shell</b>					
B1121E1-ND3G-5-50	05	Nickel	Delrin	50	3
B1121E1-ND3G-5A-50	05A	Nickel	Delrin	50	3
B1121E1-ND3G-6-50	06	Nickel	Delrin	50	3
B1121E2-003-ND3G-6-75	06	Nickel	Delrin	75	3
B1121E1-ND3G-6A-75	06A	Nickel	Delrin	75	9
B1121H1-001-ND3G-14-50	14	Nickel	Delrin	50	9
B1121A1-ND3G-16-75	16	Nickel	Delrin	75	1 or 2
B1121A1-ND3G-16A-75	16A	Nickel	Delrin	75	1 or 2
B1121A9-010-NT30G-16-75*	16	Nickel	Teflon	75	3
B1121A9-010-NT30G-16A-75	16A	Nickel	Teflon	75	3
<b>Diecast Shell</b>					
B1121FA-001-ND3G-5-50	05	Nickel	Delrin	50	3
B1121FA-001-ND3G-6-50	06	Nickel	Delrin	50	3

Remark: With teflon sleeve/Hex crimp size. 178"

\* Center contact .053" diameter, 30 μ" Au.

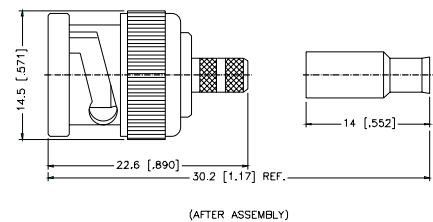
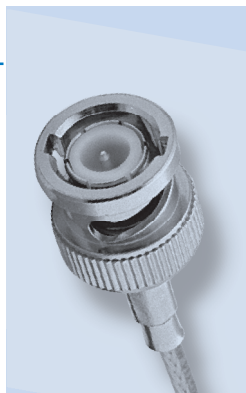

Assembly Instruction K - page 237

### Straight Solder Plug - Semi-Rigid Cable

P.N.	Cable Group	Plt.	Ins.	Imp.	Crimp Tool
B1181A1-W/3GT3G-10-50	10	Nickel/Gold	Teflon	50	N/A
B1181A1-W/NT30GA-10-75	10	Nickel/Gold	Teflon	75	N/A
B1181A1-NT3G-11-50	11	Nickel/Gold	Teflon	50	N/A

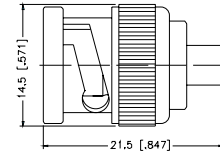

Assembly Instruction E - page 231

### Right Angle Crimp/Solder Plug - Standard Cable

P.N.	Cable Group	Plt.	Ins.	Imp.	Crimp Tool
<b>Brass Shell</b>					
B1112A1-ND3G-1-50	01	Nickel	Delrin	50	3 or 4
B1112A1-ND3G-1A-50	01A	Nickel	Delrin	50	3 or 4
B1112A1-NT3G-1B-50	01B	Nickel	Teflon	50	3 or 4
B1112A1-ND3G-3-50	03	Nickel	Delrin	50	4
B1112A1-ND3G-3-75	03	Nickel	Delrin	75	4
B1112A6-NT3G-3-75*	03	Nickel	Teflon	75	4
B1112A1-NT3G-1-50	01	Nickel	Teflon	50	3 or 4
B1112A1-NT3G-3-75	03	Nickel	Teflon	75	4
B1112A4-NT3G-7-50	07	Nickel	Teflon	50	6
B1112A4-NT3G-7A-50	07A	Nickel	Teflon	50	6
B1112A4-ND3G-7B-50	07B	Nickel	Delrin	50	3 or 4
B1112A4-NT3G-7C-50	07C	Nickel	Teflon	50	6
B1112A6-NT3G-18-75*	18	Nickel	Teflon	75	4
B1112A6-NT3G-19-75*	19	Nickel	Teflon	75	9
<b>Diecast Shell</b>					
B1112B1-001-ND3G-1-50	01	Nickel	Delrin	50	3 or 4
B1112B1-001-ND3G-3-50	03	Nickel	Delrin	50	4
B1112B1-001-ND3G-3-75	03	Nickel	Delrin	75	4

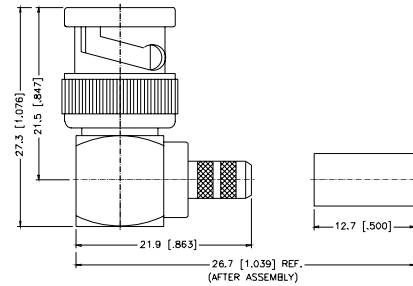
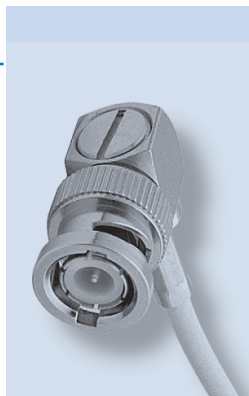

Assembly Instruction I - page 235

\* Center contact .052" diameter, 20u" Au, Tip 75 Ohm, Use .044 hex or 12-indent edmp

**Right Angle Crimp/Solder Plug - Miniature Cable**

P.N.	Cable Group	Plt.	Ins.	Imp.	Crimp Tool
<b>Brass Shell</b>					
B1112E1-ND3G-5-50	05	Nickel	Delrin	50	3
B1112E1-ND3G-5A-50	05A	Nickel	Delrin	50	9
B1112E1-ND3G-6-75	06	Nickel	Delrin	75	9
B1112E1-ND3G-6A-75	06A	Nickel	Delrin	75	3
B1112E1-ND3G-16-75	16	Nickel	Delrin	75	9
B1112E1-ND3G-16A-75	16A	Nickel	Delrin	75	9

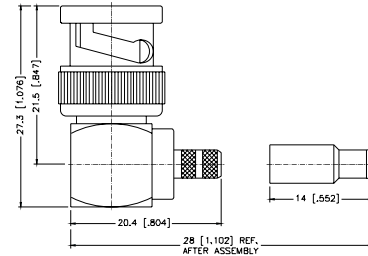
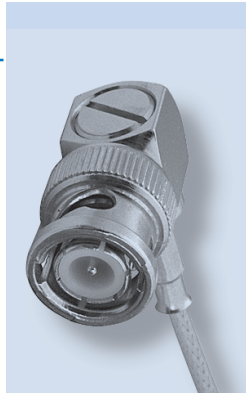

Assembly Instruction I - page 235

**Right Angle Solder Plug - Semi-Rigid Cable**

P.N.	Cable Group	Plt.	Ins.	Imp.	Crimp Tool
B1182A1-N/3GT3G-10-50	10	Nickel/Gold	Teflon	50	N/A
B1182A1-N/NT30GA-11-50	11	Nickel/Gold	Teflon	50	N/A

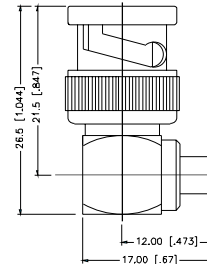
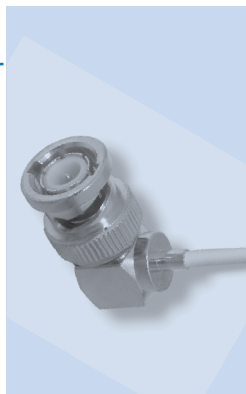

Assembly Instruction F - page 232

**Right Angle Crimp/Crimp Plug - Standard Cable**

P.N.	Cable Group	Plt.	Ins.	Imp.	Crimp Tool
<b>Brass Shell</b>					
B1122A1-ND3G-1-50	01	Nickel	Delrin	50	4
B1122A1-ND3G-3-50	03	Nickel	Delrin	50	4
B1122A1-ND3G-3-75	03	Nickel	Delrin	75	4
B1122A1-NT3G-8-75	08	Nickel	Teflon	75	5
B1122A1-NT3G-15-75	15	Nickel	Teflon	75	5
<b>Diecast Shell</b>					
B1122B1-001-ND3G-1-50	01	Nickel	Delrin	50	3 or 4
B1122B1-001-ND3G-3-75	03	Nickel	Delrin	75	4
B1122B1-001-NT3G-75	16A,16	Nickel	Teflon	75	.180 hex

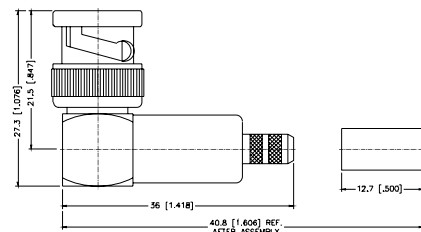
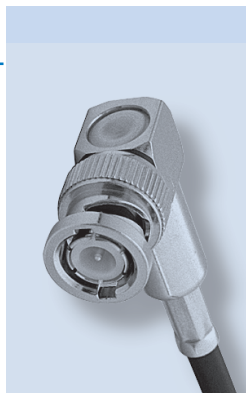

Assembly Instruction S - page 245

**Right Angle Crimp/Crimp Plug - Miniature Cable**

P.N.	Cable Group	Pit.	Ins.	Imp.	Crimp Tool
<b>Brass Shell</b>					
B1122E1-002-ND3G-5-50	05	Nickel	Delrin	50	3
B1122E1-ND3G-6-75	06	Nickel	Delrin	75	3
<b>Diecast Shell</b>					
B1122F1-001-ND3G-5-50	05	Nickel	Delrin	50	3
B1122F1-001-ND3G-6-75	06	Nickel	Delrin	75	3

Remark: With teflon sleeve Hex. crimp size .178"

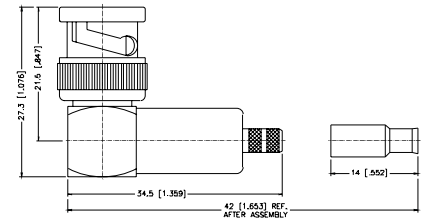
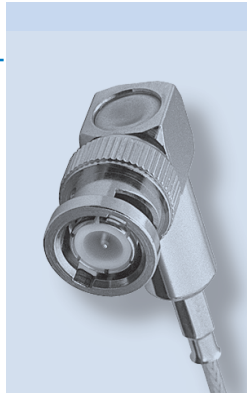

Assembly Instruction S - page 245

**Straight Crimp Jack - Miniature Cable**

P.N.	Cable Group	Pit.	Ins.	Imp.	Crimp Tool
B6121E1-ND3G-5-50	05	Nickel	Delrin	50	9
B6121E1-ND3G-5A-50	05A	Nickel	Delrin	50	9
B6121E1-ND3G-6-75	06	Nickel	Delrin	75	9
B6121E1-ND3G-6A-75	06A	Nickel	Delrin	75	9
B6121G1-NT3G-14-50	14	Nickel	Teflon	50	9
B6121B1-ND3G-16-75	16	Nickel	Delrin	75	9

Remark: With teflon sleeve, Hex crimp size .178"

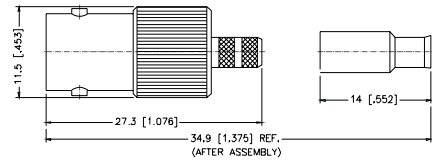
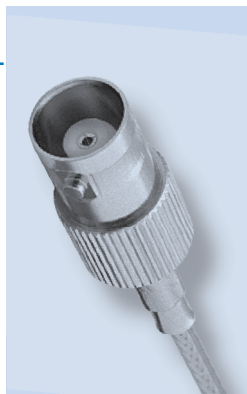

Assembly Instruction K - page 237

**Straight Crimp Jack - Standard Cable**

P.N.	Cable Group	Pit.	Ins.	Imp.	Crimp Tool
<b>Captured</b>					
B6121A1-NT3G-1-50	01	Nickel	Teflon	50	3 or 4
B6121B1-ND3G-1-50	01	Nickel	Delrin	50	3 or 4
B6121A1-004-ND3G-1A-50	01A	Nickel	Delrin	50	3 or 4
B6121A1-NT3G-1B-50	01B	Nickel	Teflon	50	4
B6121A1-NT3G-3-50	03	Nickel	Teflon	50	4
B6121A1-NT3G-3-75	03	Nickel	Teflon	75	4
B6121B1-ND3G-3-50	03	Nickel	Delrin	50	4
B6121A1-NT3G-3A-75	03A	Nickel	Teflon	75	4
B6121A1-NT3G-7B-50	07B	Nickel	Teflon	50	4
B6121A6-NT3G-7C-50	07C	Nickel	Teflon	50	1 + 6
B6121A2-NT3G-8A-75*	08A	Nickel	Teflon	75	2 + 5
B6121A2-NT3G-8B-75*	08B	Nickel	Teflon	75	2 + 5
B6121A1-NT3G-15-75	15	Nickel	Teflon	75	5
B6121A2-NT3G-18-75*	18	Nickel	Teflon	75	4
B6121A2-NT3G-19-75*	19	Nickel	Teflon	75	9

\* Center contact .052" diameter, 30 $\mu$ " Au. True 75 ohm.

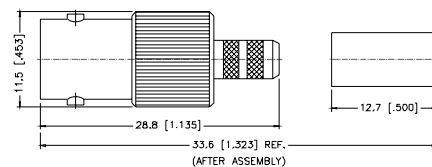
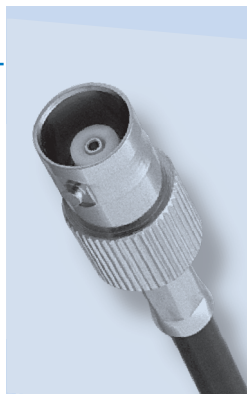

Assembly Instruction J - page 236

**Straight Solder Jack - Semi-Rigid Cable**

P.N.	Cable Group	Pit.	Ins.	Imp.	Crimp Tool
B6181A1-W/3GT3G-10-50	10	Nickel/Gold	Teflon	50	N/A
B6181A1-W/3GT3G-11-50	11	Nickel/Gold	Teflon	50	N/A

Remark: With teflon sleeve, Hex crimp size .178"

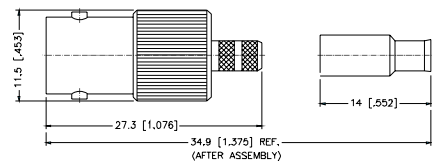
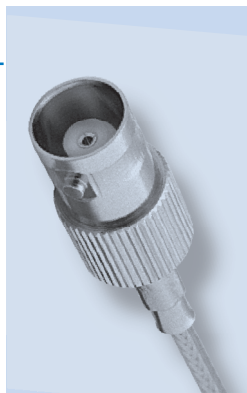

Assembly Instruction E - page 231



**Bulkhead Crimp Jack - Snap-In Panel - Miniature Cable**

P.N.	Cable Group	Pft.	Ins.	Imp.	Crimp Tool
B632100-001-NT3G-5-50	05	Nickel	Teflon	50	3

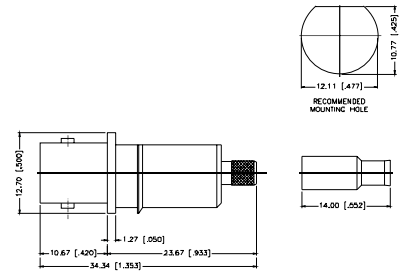
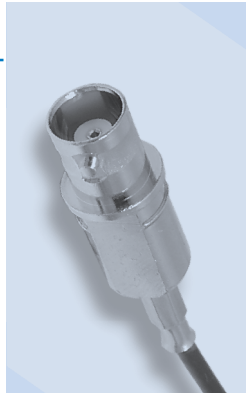

Assembly Instruction L - page 238

**Bulkhead Crimp Jack - Standard Cable**

P.N.	Cable Group	Pft.	Ins.	Imp.	Crimp Tool
<b>Teflon/Captured</b>					
B6421A1-NT3G-1-50	01	Nickel	Teflon	50	4
B6421A1-ND3G-1A-50	01A	Nickel	Delrin	50	4
B6421A1-NT3G-1B-50	01B	Nickel	Teflon	50	3 or 4
B6421A1-NT3G-3-50	03	Nickel	Teflon	50	4
B6421A1-NT3G-3-75	03	Nickel	Teflon	75	4
B6421A1-NT3G-3A-50	03A	Nickel	Teflon	50	4
B6421A1-NT3G-7B-50	07B	Nickel	Teflon	50	4
B6421A6-NT3G-7C-50	07C	Nickel	Teflon	50	1 + 6
B6421A1-NT3G-15-75	15	Nickel	Teflon	75	3
B6421A1-003-NT3G-75	16,16A	Nickel	Teflon	75	.180 hex
<b>Delrin/Non Captured</b>					
B6421B1-ND3G-1-50	01	Nickel	Delrin	50	3 or 4
B6421B1-ND3G-3-50	03	Nickel	Delrin	50	4
B6421B1-ND3G-3-75	03	Nickel	Delrin	75	4

Remark: 3.5 [.138] Max. panel thickness

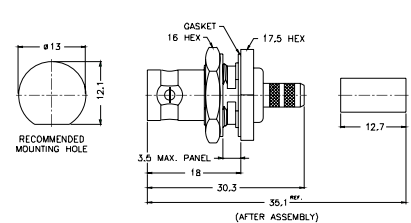
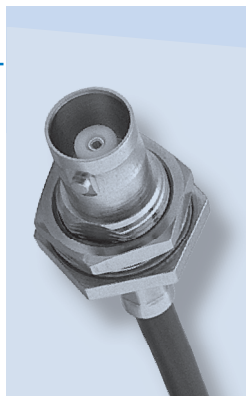

Assembly Instruction J - page 236

P.N.	Cable Group	Pft.	Ins.	Imp.	Crimp Tool
B6421A2-NT3G-1-50	01	Nickel	Teflon	50	4
B6421A2-NT3G-3-75	03	Nickel	Teflon	75	4

Remark: 6.5 [.256] Max. panel thickness

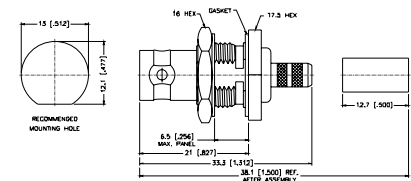
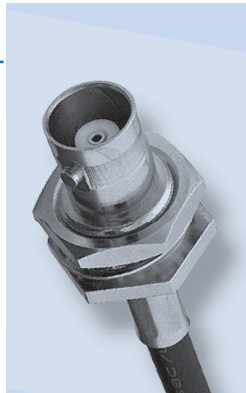

Assembly Instruction J - page 236



**Bulkhead Isolated Crimp Jack - Miniature Cable**

P.N.	Cable Group	Pit.	Ins.	Imp.	Crimp Tool
B6721E1-NT3G-5-50	05	Nickel	Teflon	50	9
B6721E1-NT3G-6-75	06	Nickel	Teflon	75	9

Remark: 6.0 [.236] Max. panel thickness

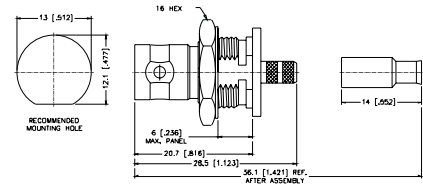
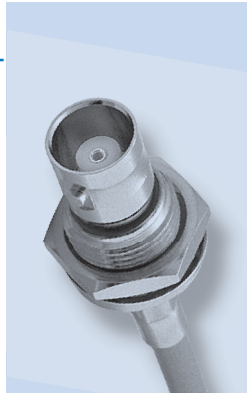

Assembly Instruction J - page 236

**Bulkhead Crimp Jack - Miniature Cable**

P.N.	Cable Group	Pit.	Ins.	Imp.	Crimp Tool
B6421E1-ND3G-5-50	05	Nickel	Delrin	50	9
B6421E1-ND3G-5A-50	05A	Nickel	Delrin	50	9
B6321A2-001-NT3G-5A-50 Front Mount	05A	Nickel	Teflon	50	2
B6421E1-ND3G-6-75	06	Nickel	Delrin	75	9
B6421E1-ND3G-6A-75	06A	Nickel	Delrin	75	3
B6421G1-ND3G-14-50	14	Nickel	Delrin	50	1 or 2
B6421A1-NT3G-16-75	16	Nickel	Teflon	75	3
B6421A3-NT3G-16A-75	16A	Nickel	Teflon	75	3
B6421A3-NT3G-18-75*	18	Nickel	Teflon	75	4
B6421A3-NT3G-19-75*	19	Nickel	Teflon	75	9

\* Center contact .052" diameter, 30µ" Au, true 75 ohm. Use .044 hex crimp or 12-indent crimp

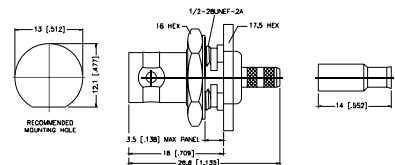
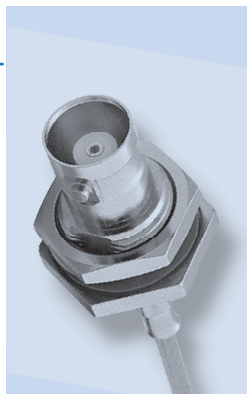

Assembly Instruction J - page 236

B6321A2-003-NT3G-5-50 Front Mount	05	Nickel	Teflon	50	1 or 2
B6321A2-005-NT3G-5A-50 Front Mount	05A	Nickel	Teflon	50	2

Remark: With teflon sleeve, Hex crimp size .178", 3.5 [.138] Max. panel thickness



B6321A2-003-NT3G-5-50, B6321A2-005-NT3G-5A-50

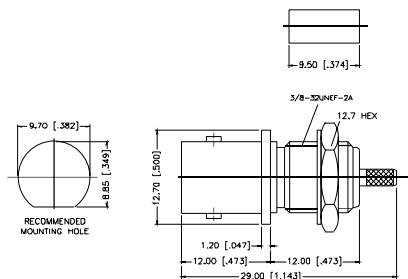

Assembly Instruction J - page 236

**Bulkhead Solder Jack - Semi-Rigid Cable**

P.N.	Cable Group	Pit.	Ins.	Imp.	Crimp Tool
B6481A1-N/3GT3G-10-50	10	Nickel/Gold	Teflon	50	N/A
B6481A1-N/3GT3G-11-50	11	Nickel/Gold	Teflon	50	N/A
B6381A1-N/3GT3G-11-50 Front Mount	11	Nickel/Gold	Teflon	50	N/A
B6381-N/3GT3G-11-75 Front Mount	11	Nickel/Gold	Teflon	75	N/A

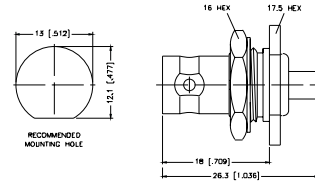

Assembly Instruction E - page 231

**Bulkhead Isolated Crimp Jack - Standard Cable**

P.N.	Cable Group	Pit.	Ins.	Imp.	Crimp Tool
<b>Teflon/Captured</b>					
B6721A1-NT3G-1-50	01	Nickel	Teflon	50	4
B6721A1-NT3G-1A-50	01A	Nickel	Teflon	50	4
B6721A1-NT3G-3-50	03	Nickel	Teflon	50	4
B6721A1-NT3G-3-75	03	Nickel	Teflon	75	4

Remark: 6.0 [0.236] Max. panel thickness

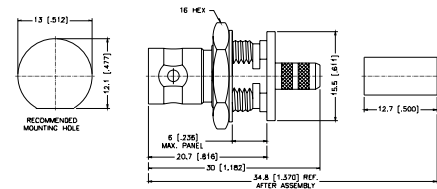
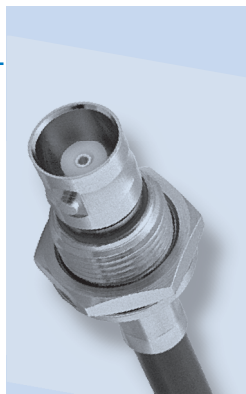

Assembly Instruction J - page 236

**Panel Crimp Jack - Standard Cable**

P.N.	Cable Group	Pit.	Ins.	Imp.	Crimp Tool
B6521A1-NT3G-1-50	01	Nickel	Teflon	50	4
B6521A1-ND3G-1A-50	01A	Nickel	Delrin	50	3 or 4
B6521A1-NT3G-3-50	03	Nickel	Teflon	50	4
B6521A1-NT3G-3-75	03	Nickel	Teflon	75	4

Remark: 5.0 [0.197] Max. panel thickness

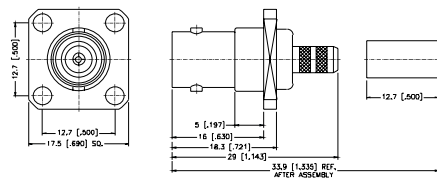
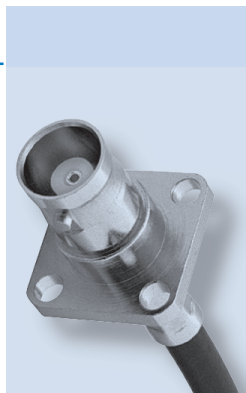

Assembly Instruction J - page 236

**Panel Crimp and Solder Jack - Miniature Cable**

P.N.	Cable Group	Pit.	Ins.	Imp.	Crimp Tool
B6521E1-NT3G-5-50	05	Nickel	Teflon	50	9
B6521F1-NT3G-5A-50	05A	Nickel	Teflon	50	9
B6521F1-ND3G-6-75	06	Nickel	Delrin	75	9

Remark: 5.0 [.197] Max. panel thickness

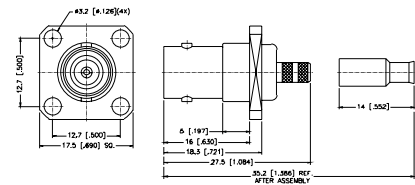
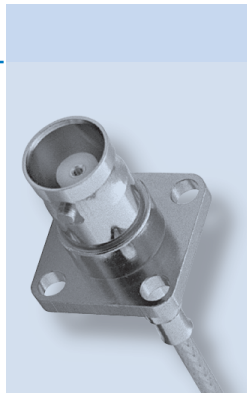

Assembly Instruction J - page 236

**Panel Crimp and Solder Jack - Semi-Rigid Cable**

P.N.	Cable Group	Pit.	Ins.	Imp.	Crimp Tool
B6581A1-N/3GT3G-10-50	10	Nickel/Gold	Teflon	50	N/A
B6581A1-N/3GT3G-11-50	11	Nickel/Gold	Teflon	50	N/A

Remark: 5.0 [.197] Max. panel thickness

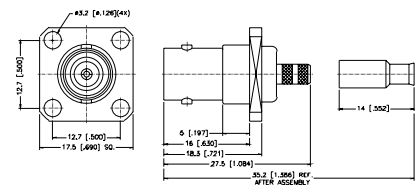
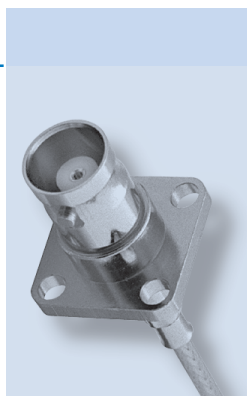

Assembly Instruction E - page 231

**Straight Clamp Plug - Captive Contact - Standard Cable**

P.N.	Cable Group	Pit.	Ins.	Imp.	Crimp Tool
B1141A1-ND3G-1-50	01	Nickel	Delrin	50	N/A
B1141A1-ND3G-3-50	03	Nickel	Delrin	50	N/A
B1141A1-ND3G-3-75	03	Nickel	Delrin	75	N/A
B1141C1-NT3G-5-50	05	Nickel	Teflon	50	N/A
B1141A2-NT3G-7A-50	07A	Nickel	Teflon	50	N/A
B1141A2-NT3G-7E-75	07E	Nickel	Teflon	75	N/A

Remark: Barrel O.D. = 12.5 mm

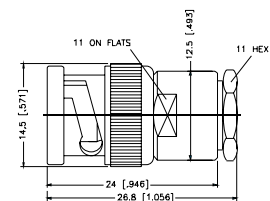
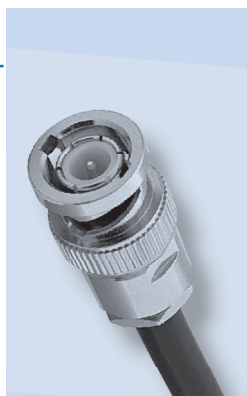

Assembly Instruction M - page 239

P.N.	Cable Group	Pit.	Ins.	Imp.	Crimp Tool
<b>Brass Shell</b>					
B1141C1-ND3G-1-50	01	Nickel	Delrin	50	N/A
B1141C1-ND3G-3-50	03	Nickel	Delrin	50	N/A
B1141C1-ND3G-3-75	03	Nickel	Delrin	75	N/A
<b>Diecast Shell</b>					
B1141D1-001-ND3G-1-50	01	Nickel	Delrin	50	N/A
B1141D1-ND3G-3-50	03	Nickel	Delrin	50	N/A

Remark: UG-88/U, UG-260/U

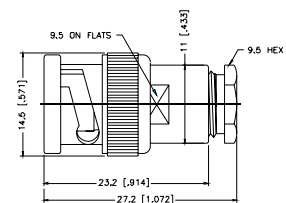

Assembly Instruction M - page 239

**Right Angle Clamp Plug - Standard Cable**

P.N.	Cable Group	Pit.	Ins.	Imp.	Crimp Tool
<b>Brass Shell</b>					
B1142E1-ND3G-1-50	01	Nickel	Delrin	50	N/A
B1142E1-ND3G-3-50	03	Nickel	Delrin	50	N/A
B1142E1-ND3G-3-75	03	Nickel	Delrin	75	N/A

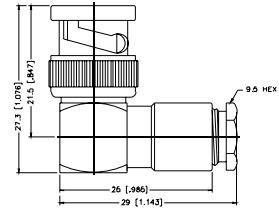
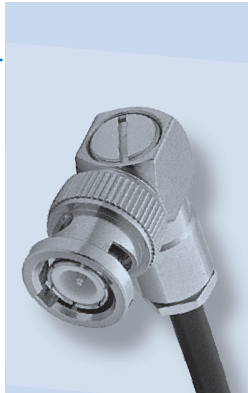

Assembly Instruction M - page 239

**Straight Clamp Jack - Captive contact - Standard Cable**

P.N.	Cable Group	Pit.	Ins.	Imp.	Crimp Tool
B6141A1-NT3G-1-50	01	Nickel	Teflon	50	N/A
B6141A1-NT3G-3-50	03	Nickel	Teflon	50	N/A
B6141A1-NT3G-3-75	03	Nickel	Teflon	75	N/A
B6141A2-NT3G-7A-50	07A	Nickel	Teflon	50	N/A

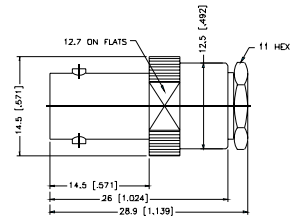
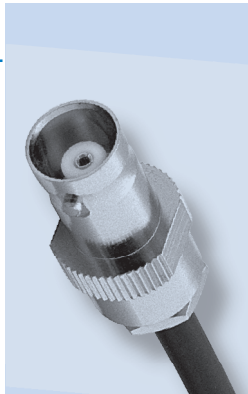

Assembly Instruction N - page 240

**Bulkhead Clamp Jack - Captive Contact - Flexible Cable**

P.N.	Cable Group	Pit.	Ins.	Imp.	Crimp Tool
B6441A2-NT3G-1-50	01	Nickel	Teflon	50	N/A

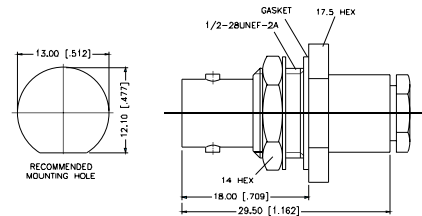

Assembly Instruction N - page 240

**Twist-On Plug - Standard Cable**

P.N.	Cable Group	Pit.	Ins.	Imp.	Crimp Tool
<b>Brass Shell</b>					
B1131A1-ND3G-1-50	01	Nickel	Delrin	50	N/A
B1131A1-ND3G-3-50	03	Nickel	Delrin	50	N/A
B1131A1-ND3G-3-75	03	Nickel	Delrin	75	N/A
B1131A1-ND3G-8-50	08	Nickel	Delrin	50	N/A

Remark: Only for solid center conductor cable

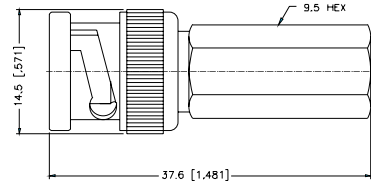
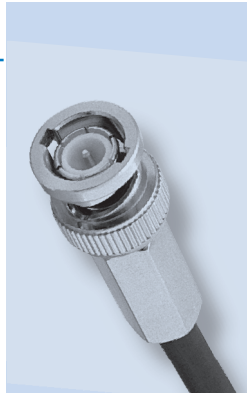

Assembly Instruction O - page 241

**Twist-On Jack - Standard Cable**

P.N.	Cable Group	Pit.	Ins.	Imp.	Crimp Tool
B6131A1-ND3G-1-50	01	Nickel	Delrin	50	N/A
B6131A1-ND3G-3-50	03	Nickel	Delrin	50	N/A

Remark: Only for solid center conductor cable

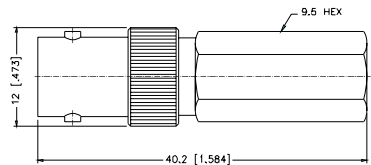
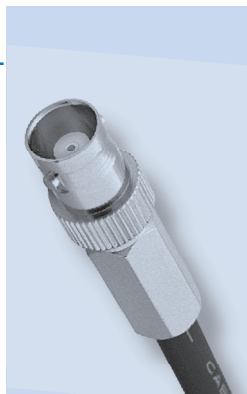

Assembly Instruction O - page 241

**Wedge compression Plug - Standard Cable**

P.N.	Cable Group	Pit.	Ins.	Imp.	Crimp Tool
<b>Brass Shell</b>					
B1141G1-ND3G-1-50	01	Nickel	Delrin	50	N/A
B1141G1-ND3G-3-50	03	Nickel	Delrin	50	N/A
B1141G1-ND3G-3-75	03	Nickel	Delrin	75	N/A

Remark: With wedge pin

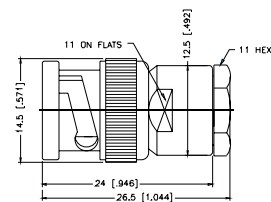

Assembly Instruction P - page 242

**Wedge Compression Jack - Standard cable**

P.N.	Cable Group	Pit.	Ins.	Imp.	Crimp Tool
B6141G1-NT3G-1-50	01	Nickel	Teflon	50	N/A
B6141G1-NT3G-3-50	03	Nickel	Teflon	50	N/A
B6141G1-NT3G-3-75	03	Nickel	Teflon	75	N/A

Remark: With wedge contact

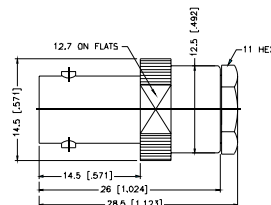
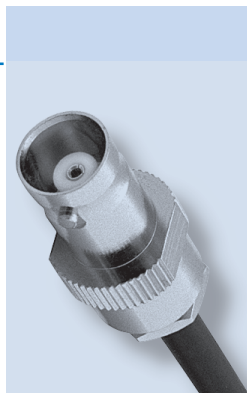

Assembly Instruction P - page 242

**Bulkhead Receptacle Plug - Front Mount**

P.N.	Cable Group	Pit.	Ins.	Imp.	Crimp Tool
Brass Shell					
B1351Q1-ND3G-50	N/A	Nickel	Delrin	50	N/A
B1351Q2-NT3G-75	N/A	Nickel	Teflon	75	N/A

Remark: 4.5 [.177] Max. panel thickness

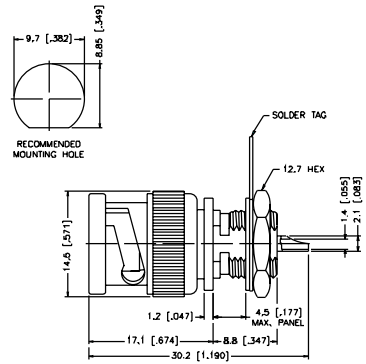
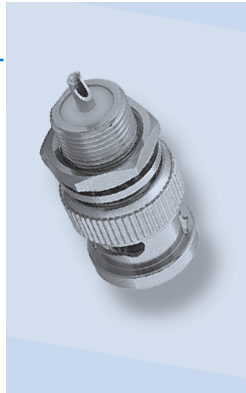

**Bulkhead Receptacle Jack - Front Mount**

P.N.	Cable Group	Pit.	Ins.	Imp.	Crimp Tool
L1 = 3.2 [.126] Max. panel thickness, L = 26.7 [1.05]					
B6351B1-ND3G-50	N/A	Nickel	Delrin	50	N/A
B6351B1-NT3G-50	N/A	Nickel	Teflon	50	N/A
B6351B1-ND3G-75	N/A	Nickel	Delrin	75	N/A
L1 = 6.5 [.256] Max. panel thickness, L = 30.0 [1.18]					
B6351B2-ND3G-50	N/A	Nickel	Delrin	50	N/A
B6351B2-ND3G-75	N/A	Nickel	Delrin	75	N/A

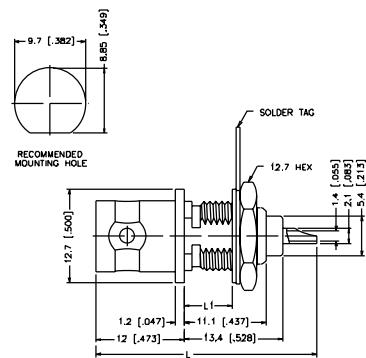
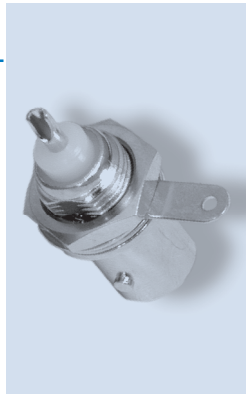

**Bulkhead Receptacle Isolated Jack - Front Mount**

P.N.	Cable Group	Pit.	Ins.	Imp.	Crimp Tool
B6651B1-NNYL3G-50	N/A	Nickel	ABS	50	N/A
B6651B1-NNYL3G-75	N/A	Nickel	ABS	75	N/A

Remark: 3.2 [.126] Max. panel thickness

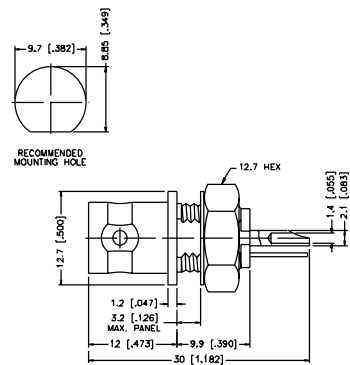

**Bulkhead Receptacle Isolated Jack - Rear Mount**

P.N.	Cable Group	Pit.	Ins.	Imp.	Crimp Tool
B675100-001-NT3G-50	N/A	Nickel	Teflon	50	N/A

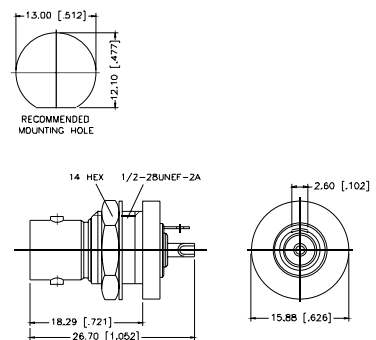
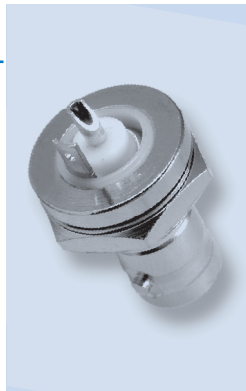

**Bulkhead Receptacle - Push Fit**

P.N.	Cable Group	Pit.	Ins.	Imp.	Crimp Tool
B6051A2-NT30G-50	N/A	Nickel	Teflon	50	N/A

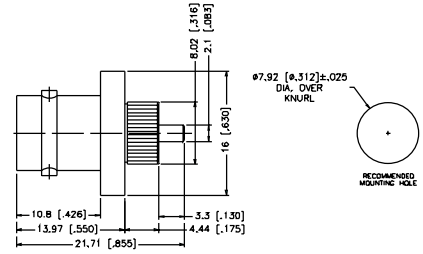
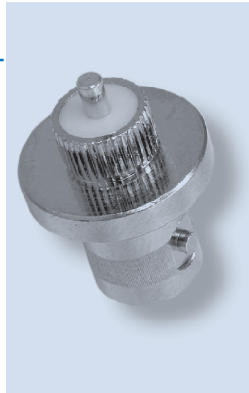

P.N.	Cable Group	Pit.	Ins.	Imp.	Crimp Tool
B6051A1-NT50G-50	N/A	Nickel	Teflon	50	N/A

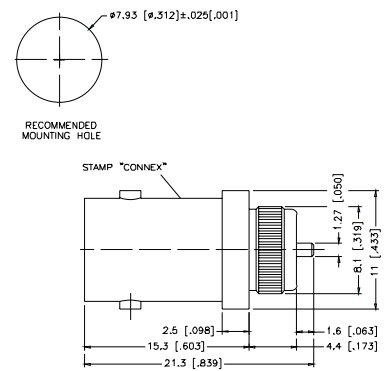

**Panel Receptacle Jack**

P.N.	Cable Group	Pit.	Ins.	Imp.	Crimp Tool
B6551A1-NT3G-50	N/A	Nickel	Teflon	50	N/A
B6551A1-NT3G-75	N/A	Nickel	Teflon	75	N/A
B6551A9-001-NT3G-50 Flush Rear 4-40 Screws	N/A	Nickel	Teflon	50	N/A

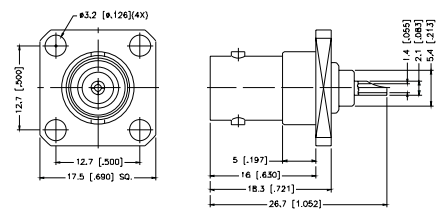
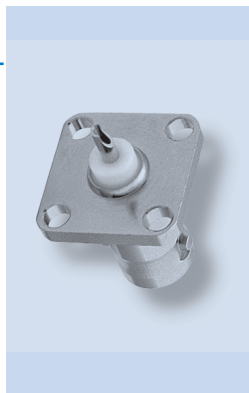



**Panel Receptacle Plug**

P.N.	Cable Group	Pit.	Ins.	Imp.	Crimp Tool
B1551A1-NT3G-50	N/A	Nickel	Teflon	50	N/A

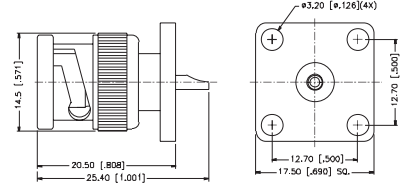
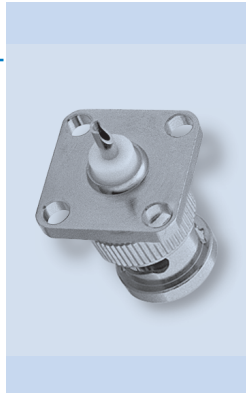

**Panel Receptacle Jack - Exposed TFE Type**

P.N.	Cable Group	Pit.	Ins.	Imp.	Crimp Tool
B6551E1-002-NT30G-50	N/A	Nickel	Teflon	50	N/A
B6551E1-002-ST30GA-50	N/A	Silver	Teflon	50	N/A

Note: Contact Amphenol for other lengths availability

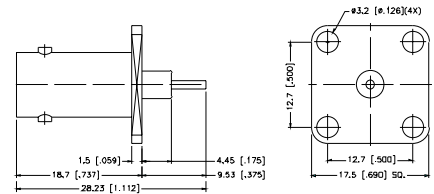
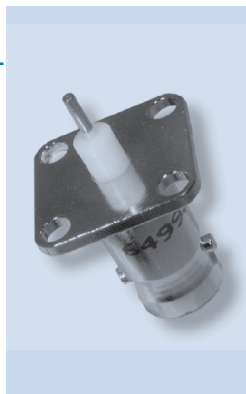

**Panel Receptacle - Exposed Teflon - Gasket Seal**

P.N.	Cable Group	Pit.	Ins.	Imp.	Crimp Tool
B6551E1-001-NT3G-50	N/A	Nickel	Teflon	50	N/A

Note: Contact Amphenol for other lengths availability

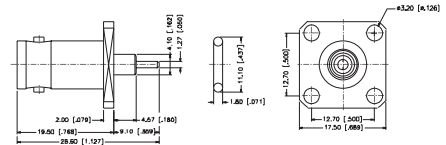
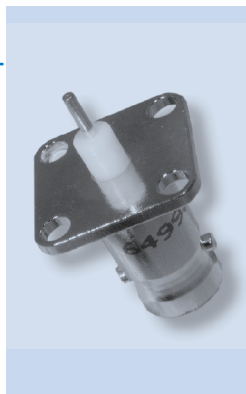

**Straight P.C. Board Mount Jack - Four Legs**

P.N.	Cable Group	Pit.	Ins.	Imp.	Crimp Tool
B6251C1-NT3G-50	N/A	Nickel	Teflon	50	N/A
B6251C1-NT3G-75	N/A	Nickel	Teflon	75	N/A

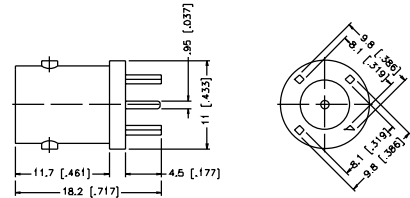
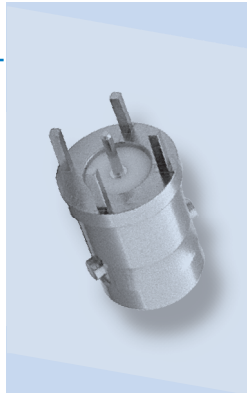

P.N.	Cable Group	Pit.	Ins.	Imp.	Crimp Tool
B6251D1-NPB3G-50	N/A	Nickel	PBT Polyester	50	N/A
B6251D1-NPB3G-75	N/A	Nickel	PBT Polyester	75	N/A

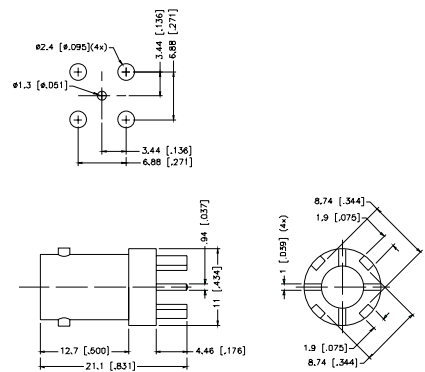
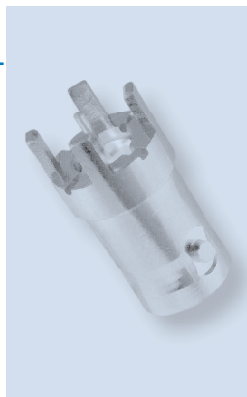

P.N.	Cable Group	Pit.	Ins.	Imp.	Crimp Tool
B6251C1-003-NT3G-50	N/A	Nickel	Teflon	50	N/A
B6251C1-004-NT3G-50 Waterproof	N/A	Nickel	Teflon	50	N/A

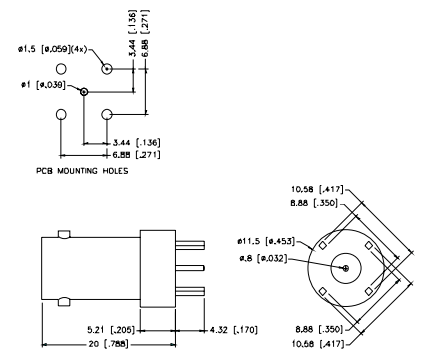
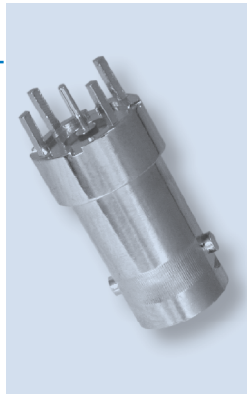

P.N.	Cable Group	Pit.	Ins.	Imp.	Crimp Tool
B625100-009-NT3G-50	N/A	Nickel	Teflon	50	N/A
B625100-009-NT3G-75	N/A	Nickel	Teflon	75	N/A

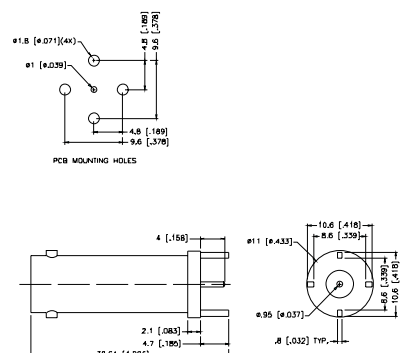
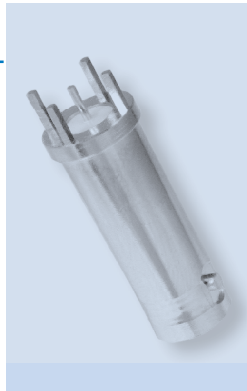

**Straight P.C. Board Mount Jack - Three Legs**

P.N.	Cable Group	Pit.	Ins.	Imp.	Crimp Tool
B6251E1-NT3G-50	N/A	Nickel	Teflon	50	N/A

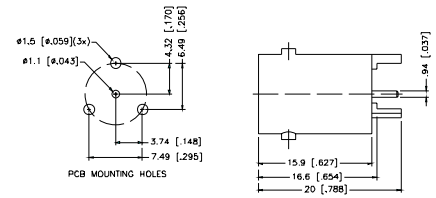
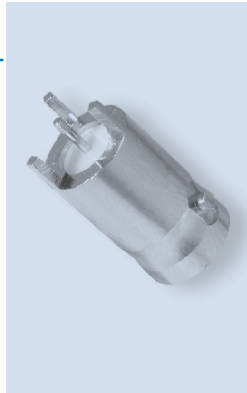

**Straight P.C. Board Mount Jack - Four Legs**

P.N.	Cable Group	Pit.	Ins.	Imp.	Crimp Tool
B6251C1-005-NT30G-75T	N/A	Nickel	Teflon	75	N/A

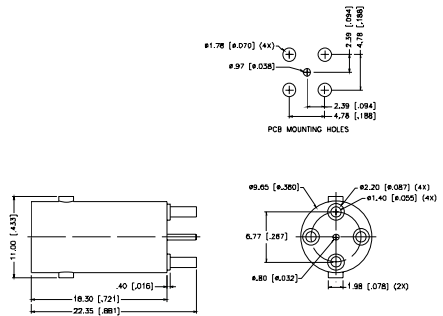
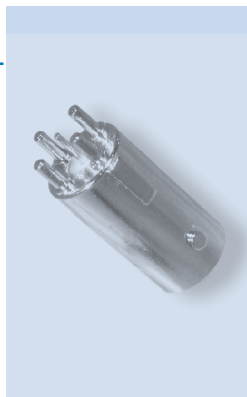

P.N.	Cable Group	Pit.	Ins.	Imp.	Crimp Tool
B6251F1-NT3G-50	N/A	Nickel	Teflon	50	N/A
B6251F1-NT3G-75	N/A	Nickel	Teflon	75	N/A

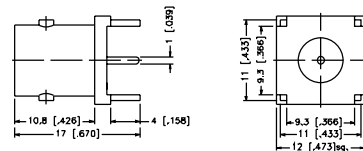
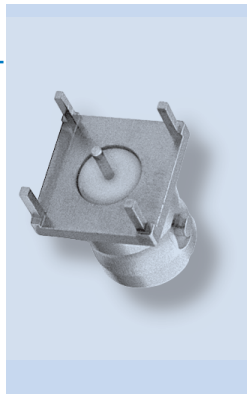

P.N.	Cable Group	Pit.	Ins.	Imp.	Crimp Tool
B625100-008-NT3G-50	N/A	Nickel	Teflon	50	N/A
B625100-005-NT3G-75	N/A	Nickel	Teflon	75	N/A

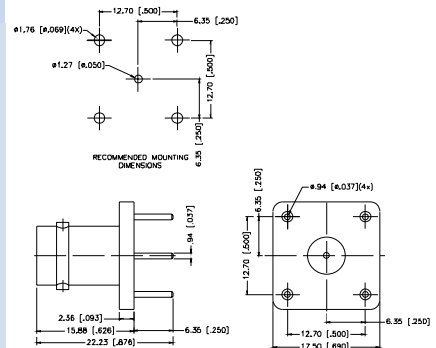
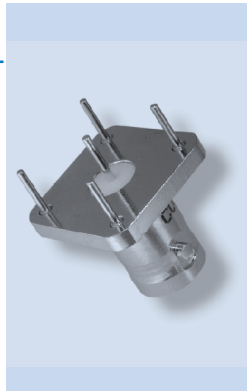

**Straight P.C. Board Edge mount Jack - End Launch**

P.N.	Cable Group	Plt.	Ins.	Imp.	Crimp Tool
B6251Q1-001-NT3G-50	N/A	Nickel	Teflon	50	N/A
B6251Q1-001-NT3G-75	N/A	Nickel	Teflon	75	N/A

Square Flange

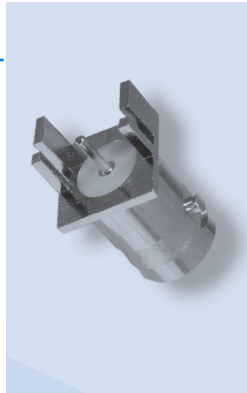

B6251Q1-001-NT3G-50

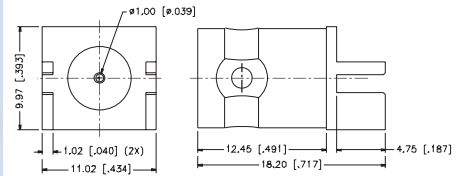

B625100-006-NT3G-50	N/A	Nickel	Teflon	50	N/A
B625100-006-NT3G-75	N/A	Nickel	Teflon	75	N/A

Round Flange

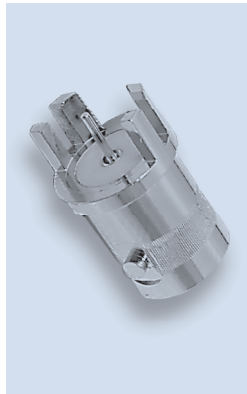

B625100-006-NT3G-50

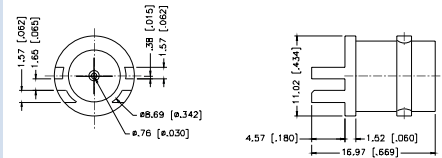

**Bulkhead Vertical P.C. Board Receptacle - End Launch**

P.N.	Cable Group	Plt.	Ins.	Imp.	Crimp Tool
B6351B1-004-NT3G-50	N/A	Nickel	Teflon	50	N/A

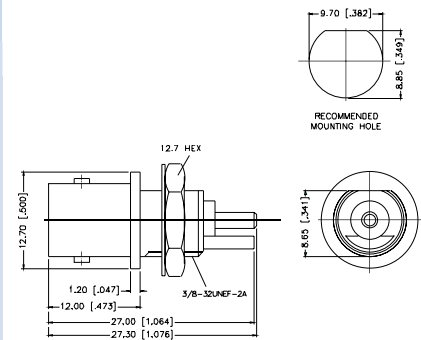

**Commercial Straight P.C. Board Mount Jack**

P.N.	Cable Group	Pit.	Ins.	Imp.	Crimp Tool
<b>White Housing</b>					
B6251G1-NPP3G-50	N/A	Nickel	Polypropylene	50	N/A
B6251G1-NPP3G-75T	N/A	Nickel	Polypropylene	75	N/A
<b>Black Housing</b>					
B6251G2-NPP3G-50	N/A	Nickel	Polypropylene	50	N/A
B6251G2-NPP3G-75T	N/A	Nickel	Polypropylene	75	N/A

Remark: Add L to part number for Locking Legs

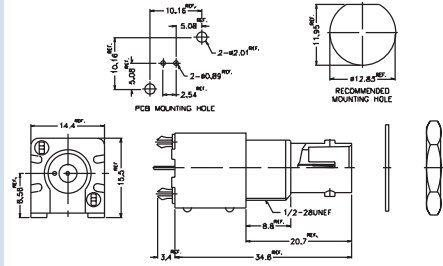
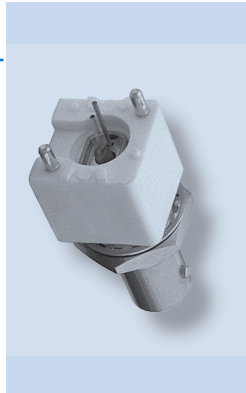

**Commercial Straight P.C. Board Mount Jack - Metal Body**

P.N.	Cable Group	Pit.	Ins.	Imp.	Crimp Tool
<b>Diecast</b>					
B6251G3-NPP3G-50	N/A	Nickel	Polypropylene	50	N/A
B6251G3-NPP3G-75T	N/A	Nickel	Polypropylene	75	N/A

Note: Connectors are shipped with lock nut and washer

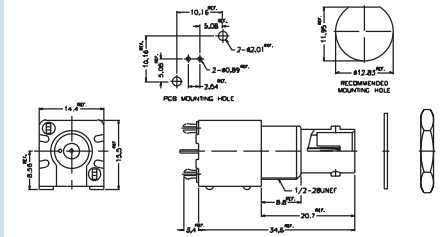
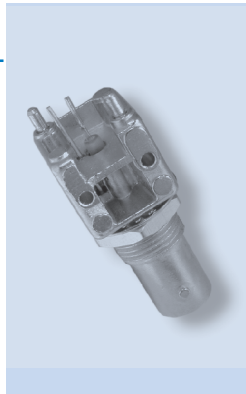

**Commercial Right Angle P.C. Board Mount Jack**

P.N.	Cable Group	Pit.	Ins.	Imp.	Crimp Tool
<b>High Profile, 15.88 [.625] White</b>					
B6252H5-NPP3G-50	N/A	Nickel	Polypropylene	50	N/A
B6252H5-NPP3G-75T	N/A	Nickel	Polypropylene	75	N/A
<b>High Profile, 15.88 [.625] Black</b>					
B6252H6-NPP3G-50	N/A	Nickel	Polypropylene	50	N/A
B6252H6-NPP3G-75T	N/A	Nickel	Polypropylene	75	N/A
<b>Low Profile, 13.1 [.516] White</b>					
B6252H7-NPP3G-50	N/A	Nickel	Polypropylene	50	N/A
B6252H7-NPP3G-75T	N/A	Nickel	Polypropylene	75	N/A
<b>Low Profile, 13.1 [.516] Black</b>					
B6252H8-NPP3G-50	N/A	Nickel	Polypropylene	50	N/A
B6252H8-NPP3G-75T	N/A	Nickel	Polypropylene	75	N/A

Note: Connectors are shipped with lock nut and washer

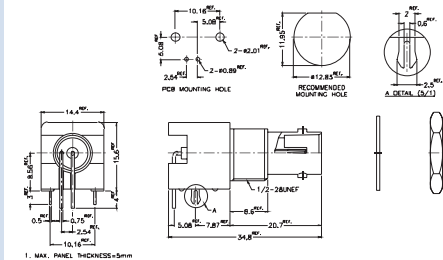
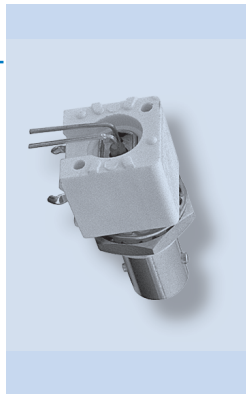

**Commercial Right Angle P.C. Board Mount Jack - Metal Body**

P.N.	Cable Group	Pit.	Ins.	Imp.	Crimp Tool
<b>Diecast</b>					
<b>High Profile, 15.88 [.625]</b>					
B6252HA-NPP3G-50	N/A	Nickel	Polypropylene	50	N/A
B6252HA-NPP3G-75T	N/A	Nickel	Polypropylene	75	N/A
<b>Low Profile, 13.1 [.516]</b>					
B6252HB-NPP3G-50	N/A	Nickel	Polypropylene	50	N/A
B6252HB-NPP3G-75T	N/A	Nickel	Polypropylene	75	N/A
UL approved UL no. E161813					
<b>High Profile, 15.88 [.625] with fork legs</b>					
B6252HC-NPP3G-50	N/A	Nickel	Polypropylene	50	N/A
B6252HC-NPP3G-75T	N/A	Nickel	Polypropylene	75	N/A
<b>Low Profile, 13.1 [.516] with fork legs</b>					
B6252HD-NPP3G-50	N/A	Nickel	Polypropylene	50	N/A
B6252HD-NPP3G-75T	N/A	Nickel	Polypropylene	75	N/A

Note: Connectors are shipped with lock nut and washer

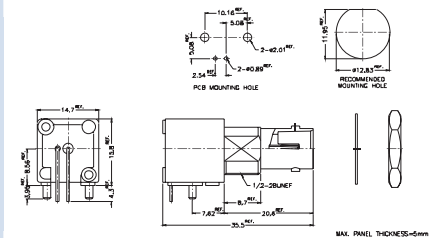

**Dual port PCB Mount Receptacle Hook**

P.N.	Cable Group	Pit.	Ins.	Imp.	Crimp Tool
B705000-NPB3G-75 Plastic body	N/A	Nickel	Polypropylene	75	N/A
B705001-NPB3G-75 Metal body	N/A	Nickel	Polypropylene	75	N/A

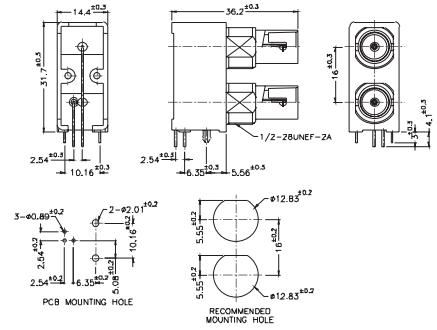
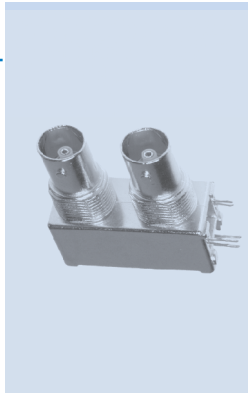

**Press-Fit PC Board Receptacle Jack**

P.N.	Cable Group	Pit.	Ins.	Imp.	Crimp Tool
B6251PF-NT10G-50	N/A	Nickel	Teflon	50	N/A

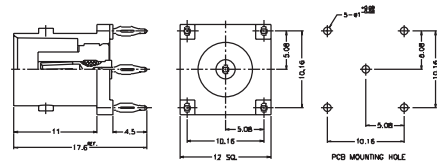
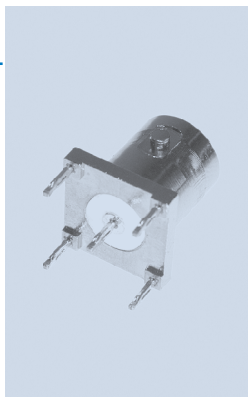

### Straight P.C. Board Receptacle Jack

P.N.	Cable Group	Plt.	Ins.	Imp.	Crimp Tool
MNB6251A1-001-NT30G-75	N/A	Nickel	Teflon	75	N/A
MNB6251A1-001-3GT30G-75	N/A	Gold	Teflon	75	N/A

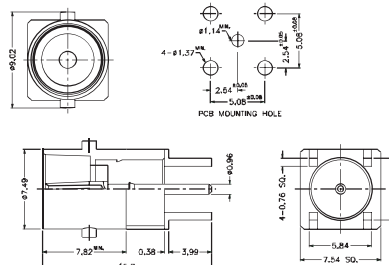
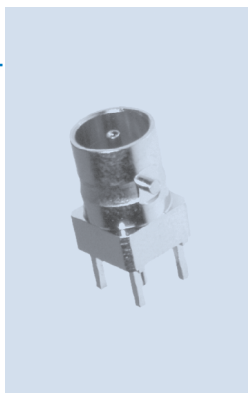

### Right Angle P.C. Board Receptacle Jack

P.N.	Cable Group	Plt.	Ins.	Imp.	Crimp Tool
MNB6252A1-001-NT30G-75	N/A	Nickel	Teflon	75	N/A

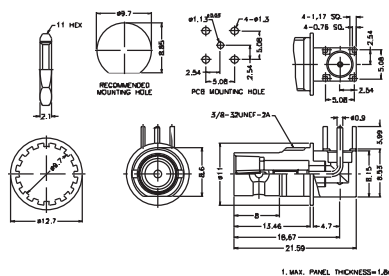
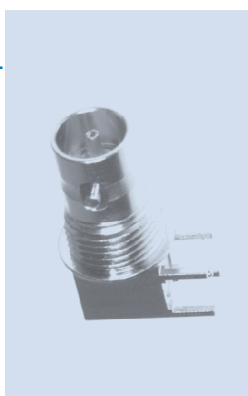

### Straight Crimp Plug

P.N.	Cable Group	Plt.	Ins.	Imp.	Crimp Tool
MNB1121A1-001-NT30G-75	19	Nickel	Teflon	75	3
MNB1121A1-001-NT30G-8A-75	08A	Nickel	Teflon	75	7.06 Hex
MNB1121A1-001-NT30G-16-75	16	Nickel	Teflon	75	3
MNB1121A1-001-NT30G-16A-75	16A	Nickel	Teflon	75	3
MNB1121C1-001-NT30G-18-75	18	Nickel	Teflon	75	4
MNB1121E1-001-NT30G-6-75	06	Nickel	Teflon	75	7

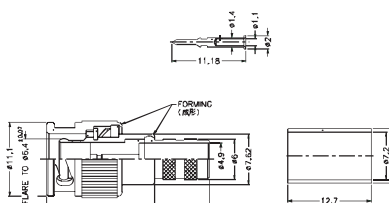

Assembly Instruction J - page 236

### Bulkhead Crimp Jack-Isolated

P.N.	Cable Group	Plt.	Ins.	Imp.	Crimp Tool
MNB6721C1-001-NT30G-75	19	Nickel	Teflon	75	3

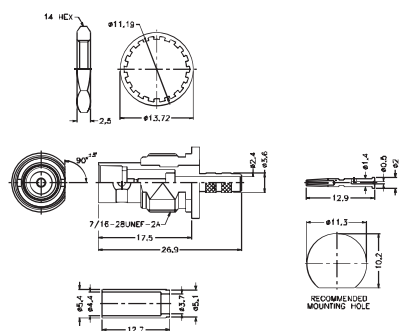

Assembly Instruction J - page 236-



### Jack-to-Jack Bulkhead Adapter

P.N.	Cable Group	Pit.	Ins.	Imp.	Crimp Tool
B7471A1-ND3G-50	N/A	Nickel	Delrin	50	N/A
B7471A1-ND3G-75	N/A	Nickel	Delrin	75	N/A

Remark: 8.0 mm [.315] Max. panel thickness, M55339/13-00492

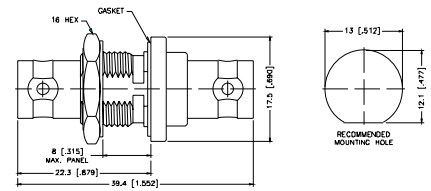
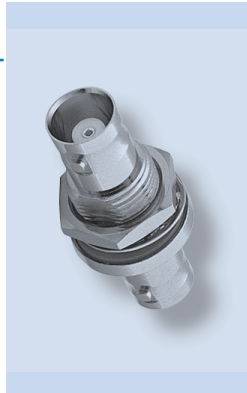

P.N.	Cable Group	Pit.	Ins.	Imp.	Crimp Tool
B7471A2-ND3G-50	N/A	Nickel	Delrin	50	N/A
B7471A2-ND3G-75	N/A	Nickel	Delrin	75	N/A

Remark: 7.0 mm [.276] Max. panel thickness, UG-492A

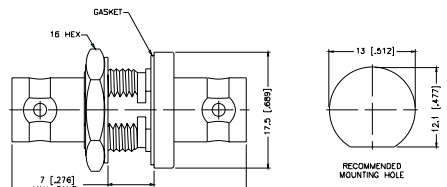

P.N.	Cable Group	Pit.	Ins.	Imp.	Crimp Tool
B7471B1-ND3G-50	N/A	Nickel	Delrin	50	N/A
B7471B1-ND3G-75	N/A	Nickel	Delrin	75	N/A

Remark: Without gasket, 5.5 mm [.217] Max. panel thickness

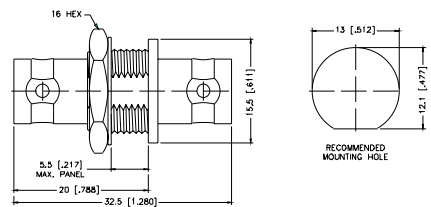
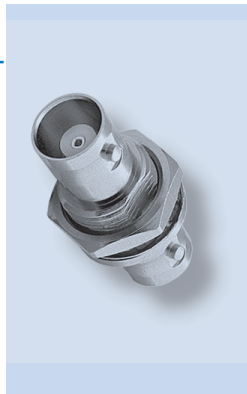

### Jack-to-Plug Bulkhead Adapter - Push-On

P.N.	Cable Group	Pit.	Ins.	Imp.	Crimp Tool
B5071A1-NT3G-75	N/A	Nickel	Teflon	75	N/A

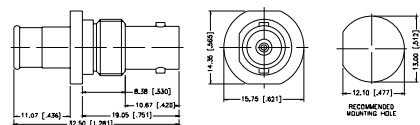

**Jack-to-Jack Bulkhead - Isolated Adapter**

P.N.	Cable Group	Pit.	Ins.	Imp.	Crimp Tool
B7771B1-ND3G-50	N/A	Nickel	Delrin	50	N/A
B7771B1-ND3G-75	N/A	Nickel	Delrin	75	N/A

Remark: With Isolated Bushing,  
4.5 mm [.177] Max. panel thickness

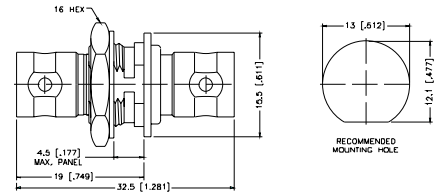
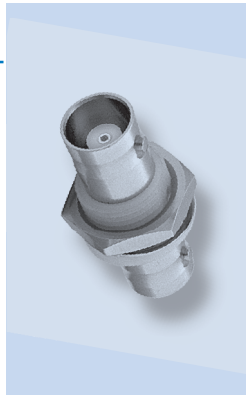

P.N.	Cable Group	Pit.	Ins.	Imp.	Crimp Tool
B7771B3-ND3G-50	N/A	Nickel	Delrin	50	N/A
B7771B3-ND3G-75	N/A	Nickel	Delrin	75	N/A

Remark: 5.5 mm [.217] Max. panel thickness

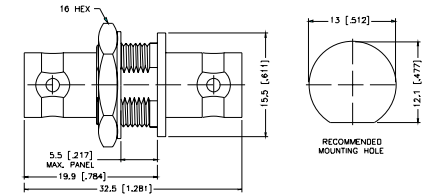
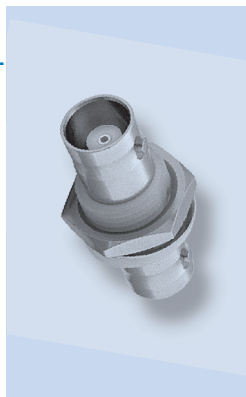

**Jack-to-Jack Adapter**

P.N.	Cable Group	Pit.	Ins.	Imp.	Crimp Tool
B7071A1-ND3G-50	N/A	Nickel	Delrin	50	N/A
B7071A1-ND3G-75	N/A	Nickel	Delrin	75	N/A

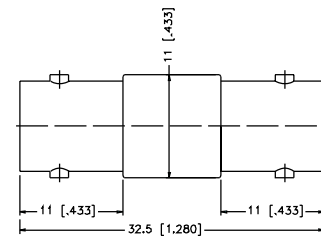

**Plug-to-Plug Adapter**

P.N.	Cable Group	Pit.	Ins.	Imp.	Crimp Tool
<b>Brass Shell</b>					
B2071A2-ND3G-50	N/A	Nickel	Delrin	50	N/A
B2071A2-ND3G-75	N/A	Nickel	Delrin	75	N/A
<b>Diecast Shell</b>					
B2071B2-002-ND3G-50	N/A	Nickel	Delrin	50	N/A
B2071B2-002-ND3G-75	N/A	Nickel	Delrin	75	N/A

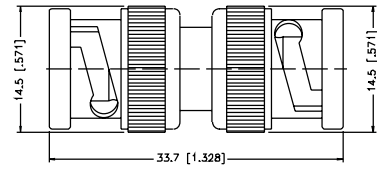

**Right Angle Adapter - Plug-to-Jack**

P.N.	Cable Group	Pit.	Ins.	Imp.	Crimp Tool
<b>Brass Shell</b>					
B5072A1-ND3G-50	N/A	Nickel	Delrin	50	N/A
B5072A1-ND3G-75	N/A	Nickel	Delrin	75	N/A
<b>Diecast Shell</b>					
B5072B1-001-ND3G-50	N/A	Nickel	Delrin	50	N/A
B5072B1-001-ND3G-75	N/A	Nickel	Delrin	75	N/A

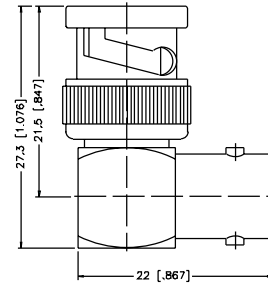
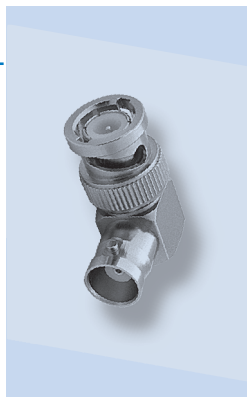

**Tee Adapter - Jack-to-Jack-to-Jack**

P.N.	Cable Group	Pit.	Ins.	Imp.	Crimp Tool
B8073A1-ND3G-50	N/A	Nickel	Delrin	50	N/A
B8073A1-ND3G-75	N/A	Nickel	Delrin	75	N/A

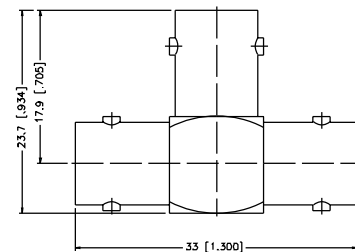
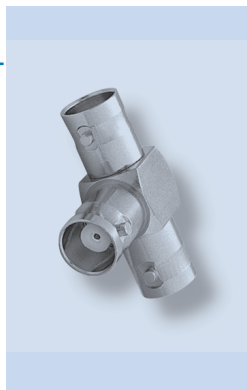

**Tee Adapter - Jack-to-Plug-to-Jack**

P.N.	Cable Group	Pit.	Ins.	Imp.	Crimp Tool
B9073D1-ND3G-50	N/A	Nickel	Delrin	50	N/A
B9073D1-ND3G-75	N/A	Nickel	Delrin	75	N/A

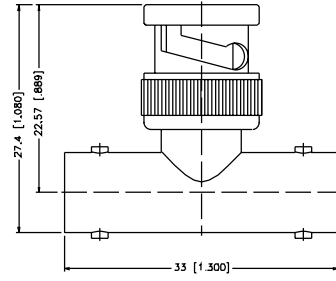
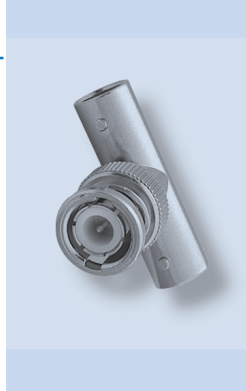

**Tee Adapter - Jack-to-Jack-to-Plug**

P.N.	Cable Group	Pit.	Ins.	Imp.	Crimp Tool
OS-7078-NDG	N/A	Nickel	Delrin	50	N/A
OS-7078-NT3G	N/A	Nickel	Teflon	50	N/A

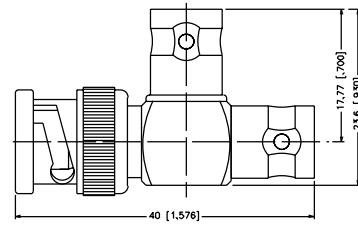
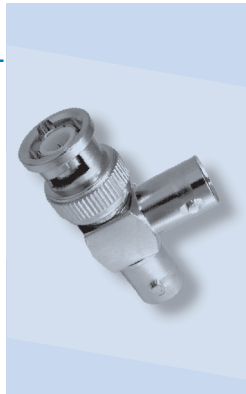

**Terminator Plug**

P.N.	Cable Group	Pit.	Ins.	Imp.	Crimp Tool
B1004A1-ND3G-50R-0.05-0.5W	N/A	Nickel	Delrin	50	N/A
B1004A1-NT3G-50R-0.5W	N/A	Nickel	Teflon	50	N/A
B1004A1-ND3G-75R-0.05-1W	N/A	Nickel	Delrin	75	N/A
B1004A1-NT3G-75R-0.05-1W	N/A	Nickel	Teflon	75	N/A
B1004A1-ND3G-93R-0.05-1W	N/A	Nickel	Delrin	93	N/A
B1004A1-NT3G-93R-0.05-1W	N/A	Nickel	Teflon	93	N/A
B1004A3-NT3G-50R High Performance	N/A	Nickel	Teflon	50	N/A
B1004A3-NT3G-75R-0.01-0.5W High Performance	N/A	Nickel	Teflon	75	N/A

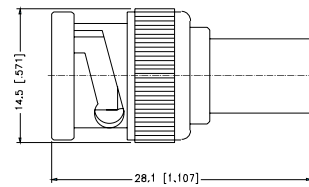
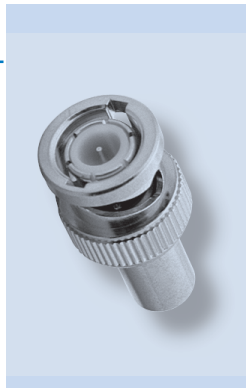

**Terminator Jack**

P.N.	Cable Group	Pit.	Ins.	Imp.	Crimp Tool
B6004A1-NT3G-50R-0.05-1W	N/A	Nickel	Teflon	50	N/A
B6004A1-NT3G-75R-0.05-1W	N/A	Nickel	Teflon	75	N/A
B6004A1-001-ND3G	N/A	Nickel	Delrin	500	N/A

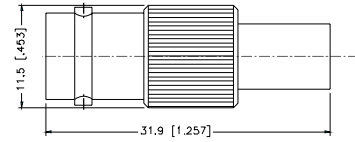
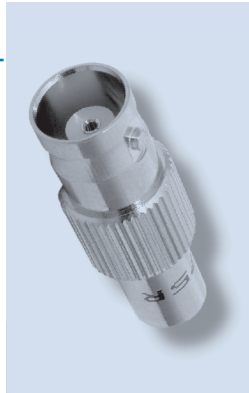

**Male Cap & Chain**

P.N.	Cable Group	Pit.	Ins.	Imp.	Crimp Tool
B1005A1-N With Chain Remark: Chain length 100 mm	N/A	Nickel	N/A	N/A	N/A
B1005A1-001-N No Chain	N/A	Nickel	N/A	N/A	N/A

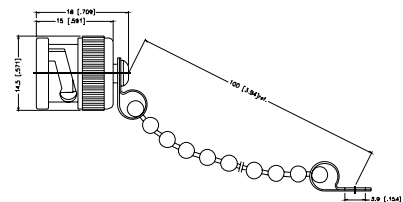

**Male Shorting Cap**

P.N.	Cable Group	Pit.	Ins.	Imp.	Crimp Tool
B1007A1-NT3G No Chain	N/A	Nickel	Teflon	N/A	N/A
B1007A2-NT3G With Chain	N/A	Nickel	Teflon	N/A	N/A

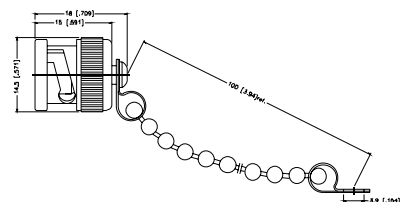

## X-ON Electronics

Largest Supplier of Electrical and Electronic Components

*Click to view similar products for [RF Connectors / Coaxial Connectors](#) category:*

*Click to view products by [Amphenol](#) manufacturer:*

Other Similar products are found below :

[R125315120](#) [8915-1511-000](#) [89674-0827](#) [5916-1103-603](#) [0106-001-000](#) [6-0001-3](#) [6001-7071-019](#) [6002-7051-003](#) [6002-7551-202](#) [6059674-1](#) [619550-1](#) [630059-000](#) [M39012/25-0021](#) [M39012/79-3008](#) [M39030/3-01N](#) [M39030/3-03N](#) [M3933/25-29N](#) [M3933/25-36N](#) [6500-7071-046](#) [6501-1071-002](#) [M83723/72W24576](#) [M83723/72W2457N](#) [6769](#) [CX050L2AQ](#) [7002-1541-010](#) [7002-1572-002](#) [7003-1572-002](#) [7004-1512-000](#) [7009-1511-004](#) [7010-1511-000](#) [7029-1511-060](#) [7101-1541-010](#) [7101-1571-002](#) [7105-1521-002](#) [7145-1521-002](#) [7209-1511-011](#) [7210-1511-012](#) [7210-1511-015](#) [7210-1511-019](#) [7210-1511-040](#) [7225-1512-050](#) [7242-1511-000](#) [73137-5015](#) [73251-0111](#) [73251-0672](#) [73276-1501](#) [73366-0013](#) [73404-2300](#) [73413-6080](#) [734151610](#)