

Description

Developed in the late 1940's, the BNC is a miniature version of the Type C. BNC stands for Bayonet Neill Concelman and is available in 50 Ohm and 75 Ohm impedance versions.

The BNC product line is a miniature quick connect / disconnect RF connector. It features two bayonet lugs on the female connector; mating is achieved with only a quarter turn of the coupling nut.

Primary Applications - Ideally suited for cable termination for miniature to subminiature coaxial cable (RG-58, 59, to RG-179, RG-316, etc.)

Features/Benefits

- Bayonet coupling mechanism provides quick mating and unmating.
- 50 and 75 ohm impedance designs allow customers to match impedance to system requirements.
- 50 and 75 ohm connectors are intermateable to ensure nondestructive mating.
- Three grades of connectors are available for military, industrial and commercial applications

Applications

- Antennas
- Automotive (GPS)
- Base Stations
- Broadcast (75 ohm)
- Cable Assemblies
- Cable Modems
- Components
- Computers/LANs
- Instrumentation
- Network Analyzers
- Oscilloscopes
- Medical Equipment
- Mil-Aerospace
- Networks
- Radios
- Satcom
- Surge Protection
- Telecom.

Specifications

Electrical

| | | |
|---------------------------------|---|---|
| Impedance | 50 ohm | 75 ohm |
| Frequency Range | 0-4 GHz | 0-1 GHz |
| Working Voltage | 500 Volts rms. | 500 Volts rms. |
| Dielectric Withstanding Voltage | 1500 Volts rms. | 1500 Volts rms. |
| VSWR | 1.3 max. 0-4 GHz | 1.05+0.1f(GHz) DC to 1 GHz |
| Contact Resistance | Center contact 1.5 milliohm Outer contact 1.0 milliohm | Center contact 1.5 milliohm Outer contact 1.0 milliohm |

Material

| | |
|-----------------------|--|
| Center Contact male | Brass, Gold or Silver plated |
| Center Contact female | Phosphor Bronze (nominal) or Beryllium Copper, Gold or Silver plated |
| Metal parts | Brass, nickel plated |
| Insulators | Teflon, Delrin, PBT polyester |
| Clamp gaskets | Silicone rubber, Synthetic rubber |
| Crimp ferrule | Annealed copper, nickel plated |

Plug

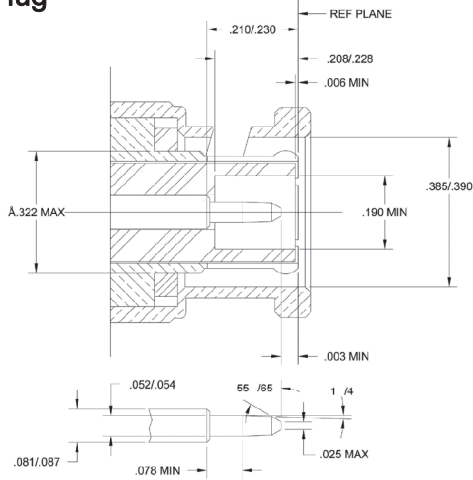

Jack

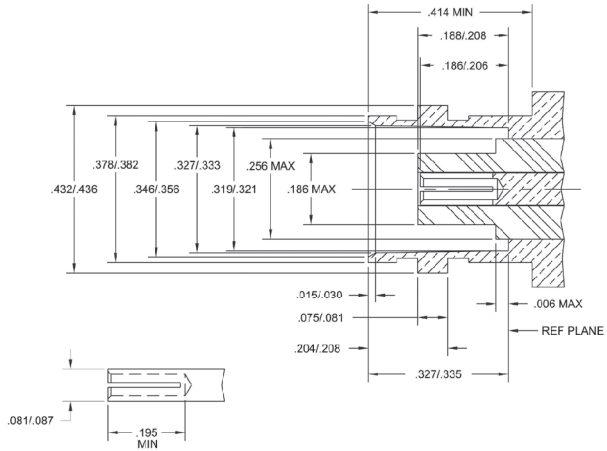

Straight Crimp Plug - Single Crimp

| P.N. | Cable Group | Pit. | Ins. | Imp. | Crimp Tool |
|------------------------|-------------|--------|--------|------|------------|
| B1111L1-001-ND3G-01-50 | 01 | Nickel | Delrin | 50 | 5 |
| B1111L1-001-ND3G-03-50 | 03 | Nickel | Delrin | 50 | 5 |

Remark: Only for Solid Center Conductor Cable

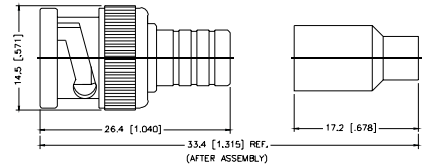
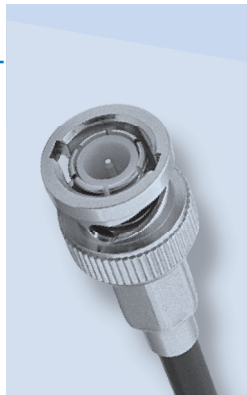

Assembly Instruction J - page 236

Straight Crimp Plug - Captive Contact - Standard Cable

| P.N. | Cable Group | Pit. | Ins. | Imp. | Crimp Tool |
|--------------------------|-------------|--------|--------|------|------------|
| B1121A1-NT3G-1-50 | 01 | Nickel | Teflon | 50 | 3 or 4 |
| B1121A1-ND3G-1-50 | 01 | Nickel | Delrin | 50 | 3 or 4 |
| B1121BA-001-ND3G-1A-50 | 01A | Nickel | Delrin | 50 | 3 or 4 |
| B1121AA-NT3G-1B-50 | 01B | Nickel | Teflon | 50 | 3 or 4 |
| B1121A1-ND3G-3-50 | 03 | Nickel | Delrin | 50 | 4 |
| B1121A1-ND3G-3-75 | 03 | Nickel | Delrin | 75 | 4 |
| B1121A9-NT3G-3-75* | 03 | Nickel | Teflon | 75 | 7 |
| B1121A1-ND3G-3A-75 | 03A | Nickel | Delrin | 75 | 4 |
| B1121A9-009-NT30G-3A-75* | 03A | Nickel | Teflon | 75 | 4 |
| B1121A6-NT3G-7-50 | 07 | Nickel | Teflon | 50 | 4 + 6 |
| B1121A6-NT3G-7A-50 | 07A | Nickel | Teflon | 50 | 4 + 6 |
| B1121A1-ND3G-7B-50 | 07B | Nickel | Delrin | 50 | 4 |
| B1121A6-NT3G-7C-50 | 07C | Nickel | Teflon | 50 | 6 |
| B1121A2-NT3G-7D-50 | 07D | Nickel | Teflon | 50 | 4 + 6 |
| B1121A6-NT3G-7E-75 | 07E | Nickel | Teflon | 75 | 2 + 6 |
| B1121A6-NT3G-7F-75 | 07F | Nickel | Teflon | 75 | 2 + 6 |
| B1121A1-ND3G-8-75 | 08 | Nickel | Delrin | 75 | 5 |
| B1121CA-002-ND3G-8A-75 | 08A | Nickel | Delrin | 75 | 5 |
| B1121A9-NT15G-8A-75* | 08A | Nickel | Teflon | 75 | 2 + 5 |
| B1121A9-NT15G-8B-75* | 08B | Nickel | Teflon | 75 | 5 |
| B1121A1-ND3G-15-75 | 15 | Nickel | Delrin | 75 | 5 |
| B1121A1-NT3G-15-75* | 15 | Nickel | Teflon | 75 | 5 |
| B1121C1-ND3G-15A-75 | 15A | Nickel | Delrin | 75 | 5 |
| B1121A9-003-NT3G-75 | 16 | Nickel | Teflon | 75 | .180 hex |
| B1121A9-003-NT3G-75 | 16A | Nickel | Teflon | 75 | .180 hex |
| B1121A9-NT15G-18-75* | 18 | Nickel | Teflon | 75 | 2 + 4 |
| B1121A9-NT15G-19-75* | 19 | Nickel | Teflon | 75 | 9 |
| B1121A1-NT3G-22-75 | 22 | Nickel | Teflon | 75 | .180 hex |
| Diecast Shell | | | | | |
| B1121BA-001-ND3G-1-50 | 01 | Nickel | Delrin | 50 | 3 or 4 |
| B1121B1-ND3G-3-50 | 03 | Nickel | Delrin | 50 | 4 |
| B1121B1-ND3G-3-75 | 03 | Nickel | Delrin | 75 | 4 |

* Center contact .053" diameter, 30 μ" Au.
True 75 ohm. Use .044 hex or 12-indent crimp

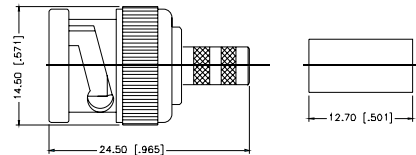
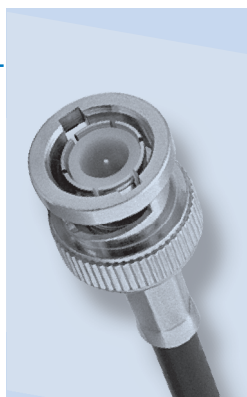

Assembly Instruction J - page 236

Straight Crimp Plug - Pin-in-Pin - Miniature Cable

| P.N. | Cable Group | Pit. | Ins. | Imp. | Crimp Tool |
|-----------------------|-------------|--------|--------|------|------------|
| Brass Shell | | | | | |
| B1121G1-ND3G-5-50 | 05 | Nickel | Delrin | 50 | 2 |
| B1121G1-ND3G-6-75 | 06 | Nickel | Delrin | 75 | 2 |
| Diecast Shell | | | | | |
| B1121H1-001-ND3G-5-50 | 05 | Nickel | Delrin | 50 | 1 or 2 |
| B1121H1-001-ND3G-6-75 | 06 | Nickel | Delrin | 75 | 2 |

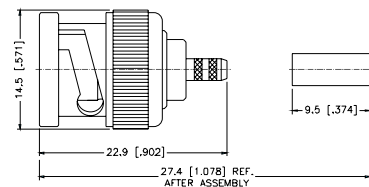
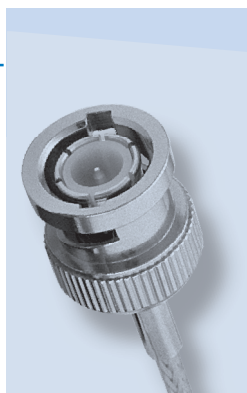

Assembly Instruction J - page 236

Straight Crimp Plug - Miniature Cable

| P.N. | Cable Group | Pit. | Ins. | Imp. | Crimp Tool |
|---|-------------|--------|------|------|------------|
| Brass Shell | | | | | |
| B1121E9-002-NTPX3G-6-75 | 06 | Nickel | TPX | 75 | 3 |
| Diecast Shell | | | | | |
| B1121F9-003-NTPX3G-6-75 | 06 | Nickel | TPX | 75 | 3 |
| Remark: TPX Insulator/75 ohm AVAILABLE ONLY | | | | | |

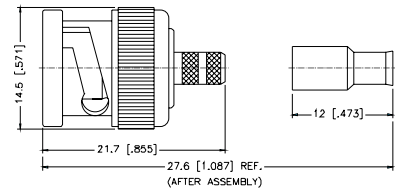
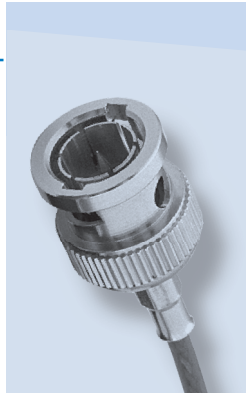

Assembly Instruction K - page 237

Straight Crimp Plug - Captive Contact - Plenum Cable

| P.N. | Cable Group | Pit. | Ins. | Imp. | Crimp Tool |
|------------------------|-------------|--------|--------|------|------------|
| B1121CA-001-ND3G-4A-75 | 04A | Nickel | Delrin | 75 | 4 |

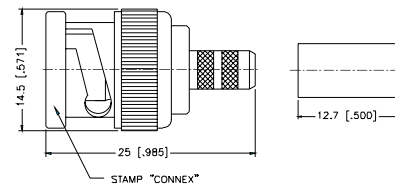
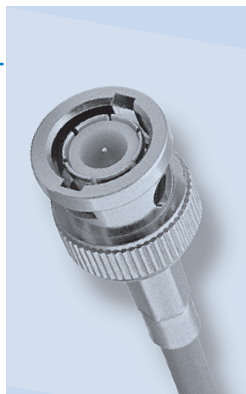

Assembly Instruction J - page 236

Straight Crimp Plug - Captive Contact - Miniature Cable

| P.N. | Cable Group | Pit. | Ins. | Imp. | Crimp Tool |
|--------------------------|-------------|--------|--------|------|------------|
| Brass Shell | | | | | |
| B1121E1-ND3G-5-50 | 05 | Nickel | Delrin | 50 | 3 |
| B1121E1-ND3G-5A-50 | 05A | Nickel | Delrin | 50 | 3 |
| B1121E1-ND3G-6-50 | 06 | Nickel | Delrin | 50 | 3 |
| B1121E2-003-ND3G-6-75 | 06 | Nickel | Delrin | 75 | 3 |
| B1121E1-ND3G-6A-75 | 06A | Nickel | Delrin | 75 | 9 |
| B1121H1-001-ND3G-14-50 | 14 | Nickel | Delrin | 50 | 9 |
| B1121A1-ND3G-16-75 | 16 | Nickel | Delrin | 75 | 1 or 2 |
| B1121A1-ND3G-16A-75 | 16A | Nickel | Delrin | 75 | 1 or 2 |
| B1121A9-010-NT30G-16-75* | 16 | Nickel | Teflon | 75 | 3 |
| B1121A9-010-NT30G-16A-75 | 16A | Nickel | Teflon | 75 | 3 |
| Diecast Shell | | | | | |
| B1121FA-001-ND3G-5-50 | 05 | Nickel | Delrin | 50 | 3 |
| B1121FA-001-ND3G-6-50 | 06 | Nickel | Delrin | 50 | 3 |

Remark: With teflon sleeve/Hex crimp size. 178"

* Center contact .053" diameter, 30 μ" Au.

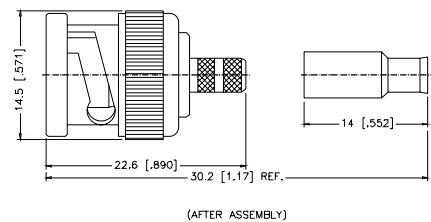
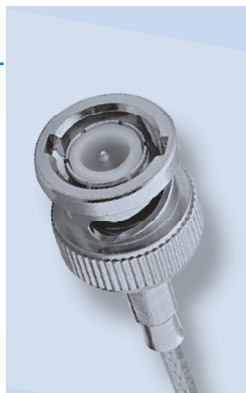

Assembly Instruction K - page 237

Straight Solder Plug - Semi-Rigid Cable

| P.N. | Cable Group | Pit. | Ins. | Imp. | Crimp Tool |
|------------------------|-------------|-------------|--------|------|------------|
| B1181A1-W/3GT3G-10-50 | 10 | Nickel/Gold | Teflon | 50 | N/A |
| B1181A1-W/NT30GA-10-75 | 10 | Nickel/Gold | Teflon | 75 | N/A |
| B1181A1-NT3G-11-50 | 11 | Nickel/Gold | Teflon | 50 | N/A |

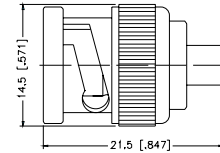

Assembly Instruction E - page 231

Right Angle Crimp/Solder Plug - Standard Cable

| P.N. | Cable Group | Pit. | Ins. | Imp. | Crimp Tool |
|-----------------------|-------------|--------|--------|------|------------|
| Brass Shell | | | | | |
| B1112A1-ND3G-1-50 | 01 | Nickel | Delrin | 50 | 3 or 4 |
| B1112A1-ND3G-1A-50 | 01A | Nickel | Delrin | 50 | 3 or 4 |
| B1112A1-NT3G-1B-50 | 01B | Nickel | Teflon | 50 | 3 or 4 |
| B1112A1-ND3G-3-50 | 03 | Nickel | Delrin | 50 | 4 |
| B1112A1-ND3G-3-75 | 03 | Nickel | Delrin | 75 | 4 |
| B1112A6-NT3G-3-75* | 03 | Nickel | Teflon | 75 | 4 |
| B1112A1-NT3G-1-50 | 01 | Nickel | Teflon | 50 | 3 or 4 |
| B1112A1-NT3G-3-75 | 03 | Nickel | Teflon | 75 | 4 |
| B1112A4-NT3G-7-50 | 07 | Nickel | Teflon | 50 | 6 |
| B1112A4-NT3G-7A-50 | 07A | Nickel | Teflon | 50 | 6 |
| B1112A4-ND3G-7B-50 | 07B | Nickel | Delrin | 50 | 3 or 4 |
| B1112A4-NT3G-7C-50 | 07C | Nickel | Teflon | 50 | 6 |
| B1112A6-NT3G-18-75* | 18 | Nickel | Teflon | 75 | 4 |
| B1112A6-NT3G-19-75* | 19 | Nickel | Teflon | 75 | 9 |
| Diecast Shell | | | | | |
| B1112B1-001-ND3G-1-50 | 01 | Nickel | Delrin | 50 | 3 or 4 |
| B1112B1-001-ND3G-3-50 | 03 | Nickel | Delrin | 50 | 4 |
| B1112B1-001-ND3G-3-75 | 03 | Nickel | Delrin | 75 | 4 |

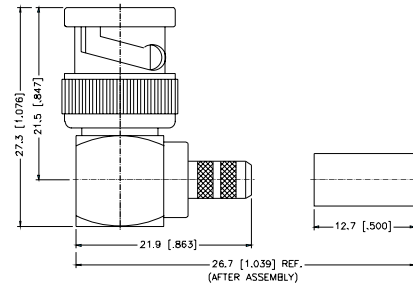

Assembly Instruction I - page 235

* Center contact .052" diameter, 20u" Au, Tin 75 Ohm, Use .044 hex or 12-indent edmp

Right Angle Crimp/Solder Plug - Miniature Cable

| P.N. | Cable Group | Plt. | Ins. | Imp. | Crimp Tool |
|---------------------|-------------|--------|--------|------|------------|
| Brass Shell | | | | | |
| B1112E1-ND3G-5-50 | 05 | Nickel | Delrin | 50 | 3 |
| B1112E1-ND3G-5A-50 | 05A | Nickel | Delrin | 50 | 9 |
| B1112E1-ND3G-6-75 | 06 | Nickel | Delrin | 75 | 9 |
| B1112E1-ND3G-6A-75 | 06A | Nickel | Delrin | 75 | 3 |
| B1112E1-ND3G-16-75 | 16 | Nickel | Delrin | 75 | 9 |
| B1112E1-ND3G-16A-75 | 16A | Nickel | Delrin | 75 | 9 |

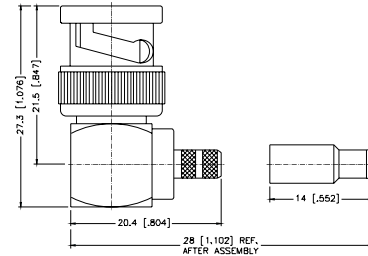
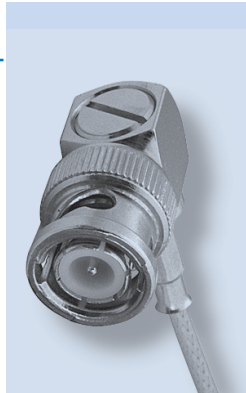

Assembly Instruction I - page 235

Right Angle Solder Plug - Semi-Rigid Cable

| P.N. | Cable Group | Plt. | Ins. | Imp. | Crimp Tool |
|------------------------|-------------|-------------|--------|------|------------|
| B1182A1-N/3GT3G-10-50 | 10 | Nickel/Gold | Teflon | 50 | N/A |
| B1182A1-N/NT30GA-11-50 | 11 | Nickel/Gold | Teflon | 50 | N/A |

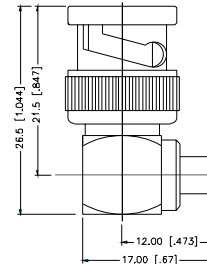

Assembly Instruction F - page 232

Right Angle Crimp/Crimp Plug - Standard Cable

| P.N. | Cable Group | Plt. | Ins. | Imp. | Crimp Tool |
|-----------------------|-------------|--------|--------|------|------------|
| Brass Shell | | | | | |
| B1122A1-ND3G-1-50 | 01 | Nickel | Delrin | 50 | 4 |
| B1122A1-ND3G-3-50 | 03 | Nickel | Delrin | 50 | 4 |
| B1122A1-ND3G-3-75 | 03 | Nickel | Delrin | 75 | 4 |
| B1122A1-NT3G-8-75 | 08 | Nickel | Teflon | 75 | 5 |
| B1122A1-NT3G-15-75 | 15 | Nickel | Teflon | 75 | 5 |
| Diecast Shell | | | | | |
| B1122B1-001-ND3G-1-50 | 01 | Nickel | Delrin | 50 | 3 or 4 |
| B1122B1-001-ND3G-3-75 | 03 | Nickel | Delrin | 75 | 4 |
| B1122B1-001-NT3G-75 | 16A,16 | Nickel | Teflon | 75 | .180 hex |

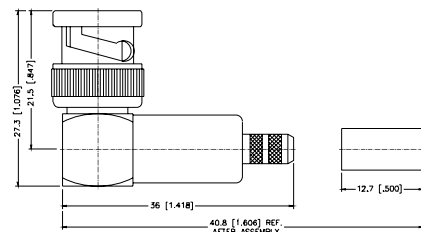
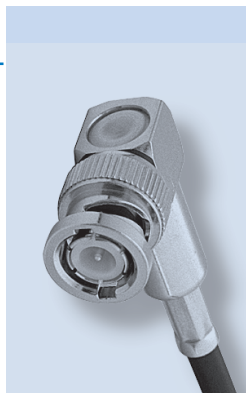

Assembly Instruction S - page 245

Right Angle Crimp/Crimp Plug - Miniature Cable

| P.N. | Cable Group | Pit. | Ins. | Imp. | Crimp Tool |
|-----------------------|-------------|--------|--------|------|------------|
| Brass Shell | | | | | |
| B1122E1-002-ND3G-5-50 | 05 | Nickel | Delrin | 50 | 3 |
| B1122E1-ND3G-6-75 | 06 | Nickel | Delrin | 75 | 3 |
| Diecast Shell | | | | | |
| B1122F1-001-ND3G-5-50 | 05 | Nickel | Delrin | 50 | 3 |
| B1122F1-001-ND3G-6-75 | 06 | Nickel | Delrin | 75 | 3 |

Remark: With teflon sleeve Hex. crimp size .178"

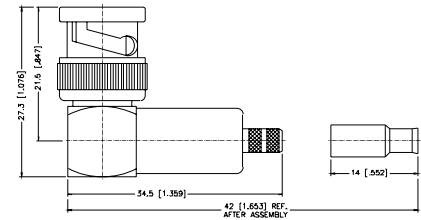
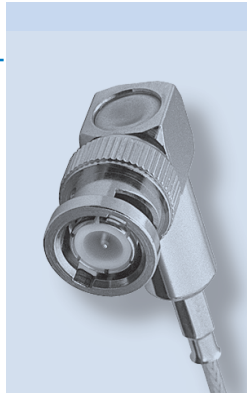

Assembly Instruction S - page 245

Straight Crimp Jack - Miniature Cable

| P.N. | Cable Group | Pit. | Ins. | Imp. | Crimp Tool |
|--------------------|-------------|--------|--------|------|------------|
| B6121E1-ND3G-5-50 | 05 | Nickel | Delrin | 50 | 9 |
| B6121E1-ND3G-5A-50 | 05A | Nickel | Delrin | 50 | 9 |
| B6121E1-ND3G-6-75 | 06 | Nickel | Delrin | 75 | 9 |
| B6121E1-ND3G-6A-75 | 06A | Nickel | Delrin | 75 | 9 |
| B6121G1-NT3G-14-50 | 14 | Nickel | Teflon | 50 | 9 |
| B6121B1-ND3G-16-75 | 16 | Nickel | Delrin | 75 | 9 |

Remark: With teflon sleeve, Hex crimp size .178"

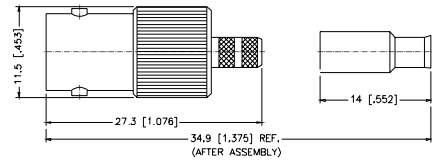
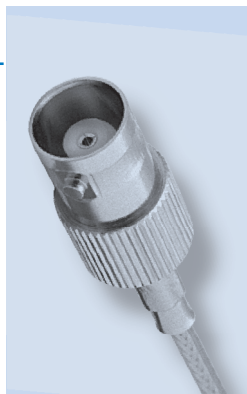

Assembly Instruction K - page 237

Straight Crimp Jack - Standard Cable

| P.N. | Cable Group | Pit. | Ins. | Imp. | Crimp Tool |
|------------------------|-------------|--------|--------|------|------------|
| Captured | | | | | |
| B6121A1-NT3G-1-50 | 01 | Nickel | Teflon | 50 | 3 or 4 |
| B6121B1-ND3G-1-50 | 01 | Nickel | Delrin | 50 | 3 or 4 |
| B6121A1-004-ND3G-1A-50 | 01A | Nickel | Delrin | 50 | 3 or 4 |
| B6121A1-NT3G-1B-50 | 01B | Nickel | Teflon | 50 | 4 |
| B6121A1-NT3G-3-50 | 03 | Nickel | Teflon | 50 | 4 |
| B6121A1-NT3G-3-75 | 03 | Nickel | Teflon | 75 | 4 |
| B6121B1-ND3G-3-50 | 03 | Nickel | Delrin | 50 | 4 |
| B6121A1-NT3G-3A-75 | 03A | Nickel | Teflon | 75 | 4 |
| B6121A1-NT3G-7B-50 | 07B | Nickel | Teflon | 50 | 4 |
| B6121A6-NT3G-7C-50 | 07C | Nickel | Teflon | 50 | 1 + 6 |
| B6121A2-NT3G-8A-75* | 08A | Nickel | Teflon | 75 | 2 + 5 |
| B6121A2-NT3G-8B-75* | 08B | Nickel | Teflon | 75 | 2 + 5 |
| B6121A1-NT3G-15-75 | 15 | Nickel | Teflon | 75 | 5 |
| B6121A2-NT3G-18-75* | 18 | Nickel | Teflon | 75 | 4 |
| B6121A2-NT3G-19-75* | 19 | Nickel | Teflon | 75 | 9 |

* Center contact .052" diameter, 30u" Au. True 75 ohm.

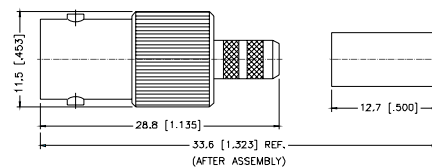
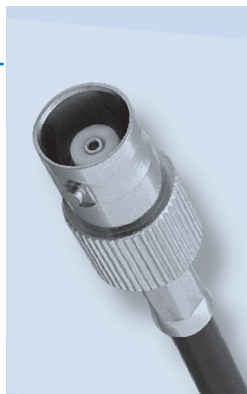

Assembly Instruction J - page 236

Straight Solder Jack - Semi-Rigid Cable

| P.N. | Cable Group | Pit. | Ins. | Imp. | Crimp Tool |
|-----------------------|-------------|-------------|--------|------|------------|
| B6181A1-W/3GT3G-10-50 | 10 | Nickel/Gold | Teflon | 50 | N/A |
| B6181A1-W/3GT3G-11-50 | 11 | Nickel/Gold | Teflon | 50 | N/A |

Remark: With teflon sleeve, Hex crimp size .178"

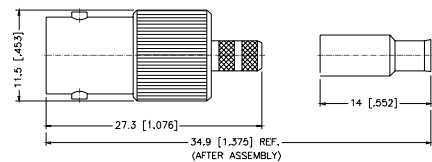
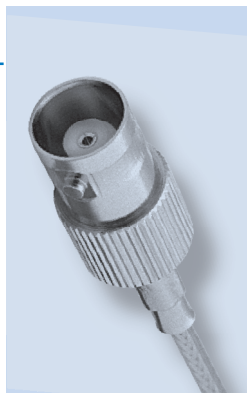

Assembly Instruction E - page 231

Bulkhead Crimp Jack - Snap-In Panel - Miniature Cable

| P.N. | Cable Group | Plt. | Ins. | Imp. | Crimp Tool |
|-----------------------|-------------|--------|--------|------|------------|
| B632100-001-NT3G-5-50 | 05 | Nickel | Teflon | 50 | 3 |

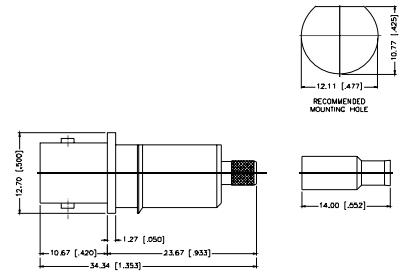

Assembly Instruction L - page 238

Bulkhead Crimp Jack - Standard Cable

| P.N. | Cable Group | Plt. | Ins. | Imp. | Crimp Tool |
|----------------------------|-------------|--------|--------|------|------------|
| Teflon/Captured | | | | | |
| B6421A1-NT3G-1-50 | 01 | Nickel | Teflon | 50 | 4 |
| B6421A1-ND3G-1A-50 | 01A | Nickel | Delrin | 50 | 4 |
| B6421A1-NT3G-1B-50 | 01B | Nickel | Teflon | 50 | 3 or 4 |
| B6421A1-NT3G-3-50 | 03 | Nickel | Teflon | 50 | 4 |
| B6421A1-NT3G-3-75 | 03 | Nickel | Teflon | 75 | 4 |
| B6421A1-NT3G-3A-50 | 03A | Nickel | Teflon | 50 | 4 |
| B6421A1-NT3G-7B-50 | 07B | Nickel | Teflon | 50 | 4 |
| B6421A6-NT3G-7C-50 | 07C | Nickel | Teflon | 50 | 1 + 6 |
| B6421A1-NT3G-15-75 | 15 | Nickel | Teflon | 75 | 3 |
| B6421A1-003-NT3G-75 | 16,16A | Nickel | Teflon | 75 | .180 hex |
| Delrin/Non Captured | | | | | |
| B6421B1-ND3G-1-50 | 01 | Nickel | Delrin | 50 | 3 or 4 |
| B6421B1-ND3G-3-50 | 03 | Nickel | Delrin | 50 | 4 |
| B6421B1-ND3G-3-75 | 03 | Nickel | Delrin | 75 | 4 |

Remark: 3.5 [138] Max. panel thickness

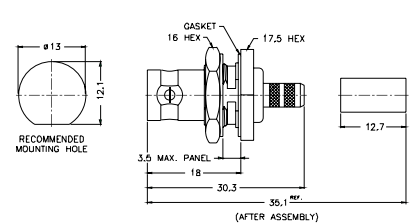
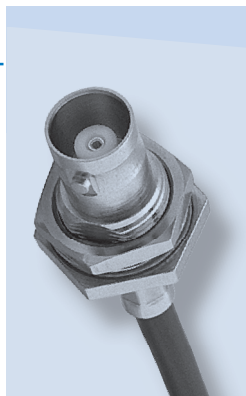

Assembly Instruction J - page 236

| P.N. | Cable Group | Plt. | Ins. | Imp. | Crimp Tool |
|-------------------|-------------|--------|--------|------|------------|
| B6421A2-NT3G-1-50 | 01 | Nickel | Teflon | 50 | 4 |
| B6421A2-NT3G-3-75 | 03 | Nickel | Teflon | 75 | 4 |

Remark: 6.5 [256] Max. panel thickness

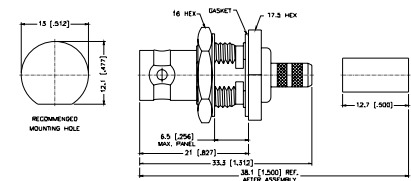
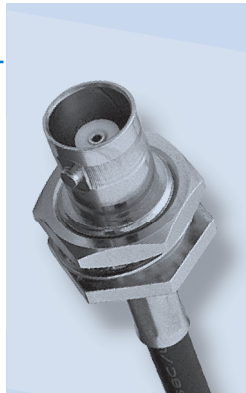

Assembly Instruction J - page 236

Bulkhead Isolated Crimp Jack - Miniature Cable

| P.N. | Cable Group | Pit. | Ins. | Imp. | Crimp Tool |
|-------------------|-------------|--------|--------|------|------------|
| B6721E1-NT3G-5-50 | 05 | Nickel | Teflon | 50 | 9 |
| B6721E1-NT3G-6-75 | 06 | Nickel | Teflon | 75 | 9 |

Remark: 6.0 [.236] Max. panel thickness

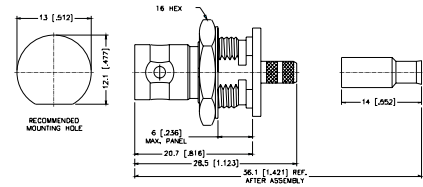
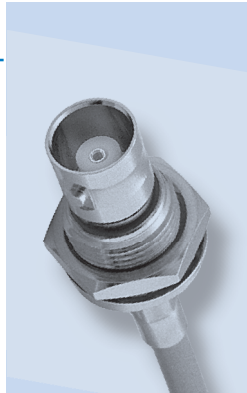

Assembly Instruction J - page 236

Bulkhead Crimp Jack - Miniature Cable

| P.N. | Cable Group | Pit. | Ins. | Imp. | Crimp Tool |
|---------------------------------------|-------------|--------|--------|------|------------|
| B6421E1-ND3G-5-50 | 05 | Nickel | Delrin | 50 | 9 |
| B6421E1-ND3G-5A-50 | 05A | Nickel | Delrin | 50 | 9 |
| B6321A2-001-NT3G-5A-50 Front Mount | 05A | Nickel | Teflon | 50 | 2 |
| B6421E1-ND3G-6-75 | 06 | Nickel | Delrin | 75 | 9 |
| B6421E1-ND3G-6A-75 | 06A | Nickel | Delrin | 75 | 3 |
| B6421G1-ND3G-14-50 | 14 | Nickel | Delrin | 50 | 1 or 2 |
| B6421A1-NT3G-16-75 | 16 | Nickel | Teflon | 75 | 3 |
| B6421A3-NT3G-16A-75 | 16A | Nickel | Teflon | 75 | 3 |
| B6421A3-NT3G-18-75* | 18 | Nickel | Teflon | 75 | 4 |
| B6421A3-NT3G-19-75* | 19 | Nickel | Teflon | 75 | 9 |

* Center contact .052" diameter, 30µ" Au, true 75 ohm. Use .044 hex crimp or 12-indent crimp

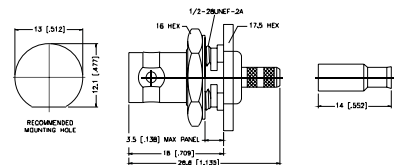
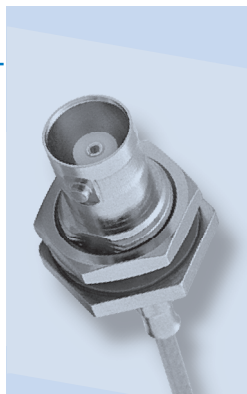

Assembly Instruction J - page 236

| | | | | | |
|---------------------------------------|-----|--------|--------|----|--------|
| B6321A2-003-NT3G-5-50 Front Mount | 05 | Nickel | Teflon | 50 | 1 or 2 |
| B6321A2-005-NT3G-5A-50 Front Mount | 05A | Nickel | Teflon | 50 | 2 |

Remark: With teflon sleeve, Hex crimp size .178", 3.5 [.138] Max. panel thickness



B6321A2-003-NT3G-5-50, B6321A2-005-NT3G-5A-50

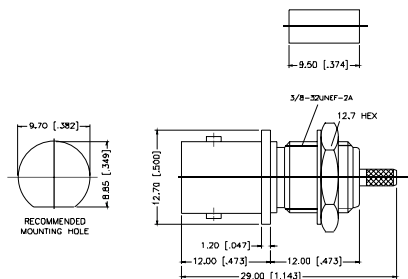

Assembly Instruction J - page 236

Bulkhead Solder Jack - Semi-Rigid Cable

| P.N. | Cable Group | Pit. | Ins. | Imp. | Crimp Tool |
|--------------------------------------|-------------|-------------|--------|------|------------|
| B6481A1-N/3GT3G-10-50 | 10 | Nickel/Gold | Teflon | 50 | N/A |
| B6481A1-N/3GT3G-11-50 | 11 | Nickel/Gold | Teflon | 50 | N/A |
| B6381A1-N/3GT3G-11-50 Front Mount | 11 | Nickel/Gold | Teflon | 50 | N/A |
| B6381-N/3GT3G-11-75 Front Mount | 11 | Nickel/Gold | Teflon | 75 | N/A |

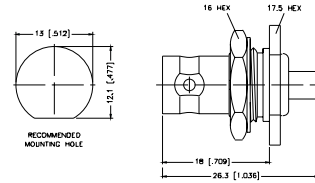

Assembly Instruction E - page 231

Bulkhead Isolated Crimp Jack - Standard Cable

| P.N. | Cable Group | Pit. | Ins. | Imp. | Crimp Tool |
|------------------------|-------------|--------|--------|------|------------|
| Teflon/Captured | | | | | |
| B6721A1-NT3G-1-50 | 01 | Nickel | Teflon | 50 | 4 |
| B6721A1-NT3G-1A-50 | 01A | Nickel | Teflon | 50 | 4 |
| B6721A1-NT3G-3-50 | 03 | Nickel | Teflon | 50 | 4 |
| B6721A1-NT3G-3-75 | 03 | Nickel | Teflon | 75 | 4 |

Remark: 6.0 [0.236] Max. panel thickness

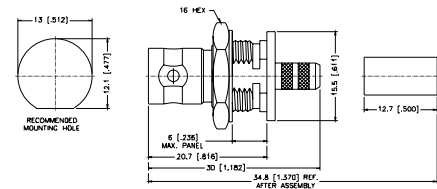
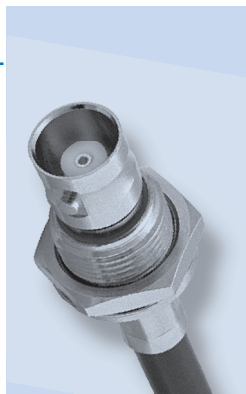

Assembly Instruction J - page 236

Panel Crimp Jack - Standard Cable

| P.N. | Cable Group | Pit. | Ins. | Imp. | Crimp Tool |
|--------------------|-------------|--------|--------|------|------------|
| B6521A1-NT3G-1-50 | 01 | Nickel | Teflon | 50 | 4 |
| B6521A1-ND3G-1A-50 | 01A | Nickel | Delrin | 50 | 3 or 4 |
| B6521A1-NT3G-3-50 | 03 | Nickel | Teflon | 50 | 4 |
| B6521A1-NT3G-3-75 | 03 | Nickel | Teflon | 75 | 4 |

Remark: 5.0 [0.197] Max. panel thickness

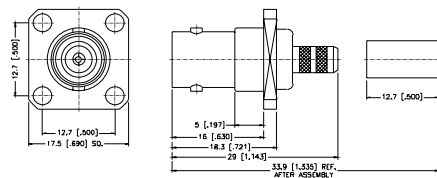
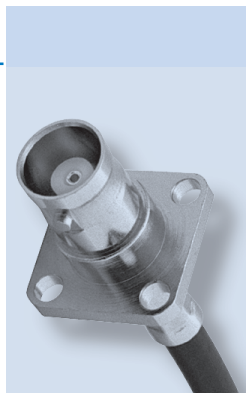

Assembly Instruction J - page 236

Panel Crimp and Solder Jack - Miniature Cable

| P.N. | Cable Group | Pit. | Ins. | Imp. | Crimp Tool |
|--------------------|-------------|--------|--------|------|------------|
| B6521E1-NT3G-5-50 | 05 | Nickel | Teflon | 50 | 9 |
| B6521F1-NT3G-5A-50 | 05A | Nickel | Teflon | 50 | 9 |
| B6521F1-ND3G-6-75 | 06 | Nickel | Delrin | 75 | 9 |

Remark: 5.0 [.197] Max. panel thickness

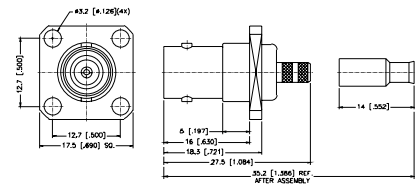
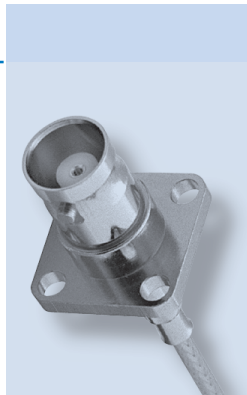

Assembly Instruction J - page 236

Panel Crimp and Solder Jack - Semi-Rigid Cable

| P.N. | Cable Group | Pit. | Ins. | Imp. | Crimp Tool |
|-----------------------|-------------|-------------|--------|------|------------|
| B6581A1-N/3GT3G-10-50 | 10 | Nickel/Gold | Teflon | 50 | N/A |
| B6581A1-N/3GT3G-11-50 | 11 | Nickel/Gold | Teflon | 50 | N/A |

Remark: 5.0 [.197] Max. panel thickness

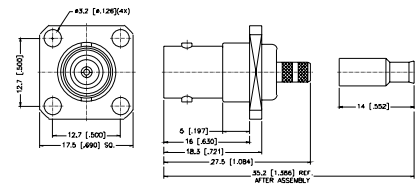
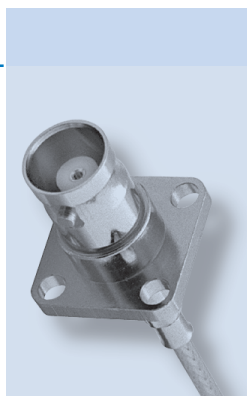

Assembly Instruction E - page 231

Straight Clamp Plug - Captive Contact - Standard Cable

| P.N. | Cable Group | Pit. | Ins. | Imp. | Crimp Tool |
|--------------------|-------------|--------|--------|------|------------|
| B1141A1-ND3G-1-50 | 01 | Nickel | Delrin | 50 | N/A |
| B1141A1-ND3G-3-50 | 03 | Nickel | Delrin | 50 | N/A |
| B1141A1-ND3G-3-75 | 03 | Nickel | Delrin | 75 | N/A |
| B1141C1-NT3G-5-50 | 05 | Nickel | Teflon | 50 | N/A |
| B1141A2-NT3G-7A-50 | 07A | Nickel | Teflon | 50 | N/A |
| B1141A2-NT3G-7E-75 | 07E | Nickel | Teflon | 75 | N/A |

Remark: Barrel O.D. = 12.5 mm

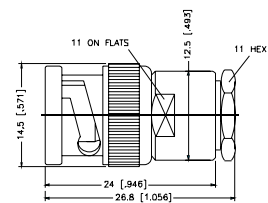

Assembly Instruction M - page 239

| P.N. | Cable Group | Pit. | Ins. | Imp. | Crimp Tool |
|--------------------|-------------|--------|--------|------|------------|
| Brass Shell | | | | | |
| B1141C1-ND3G-1-50 | 01 | Nickel | Delrin | 50 | N/A |
| B1141C1-ND3G-3-50 | 03 | Nickel | Delrin | 50 | N/A |
| B1141C1-ND3G-3-75 | 03 | Nickel | Delrin | 75 | N/A |

| P.N. | Cable Group | Pit. | Ins. | Imp. | Crimp Tool |
|-----------------------|-------------|--------|--------|------|------------|
| Diecast Shell | | | | | |
| B1141D1-001-ND3G-1-50 | 01 | Nickel | Delrin | 50 | N/A |
| B1141D1-ND3G-3-50 | 03 | Nickel | Delrin | 50 | N/A |

Remark: UG-88/U, UG-260/U

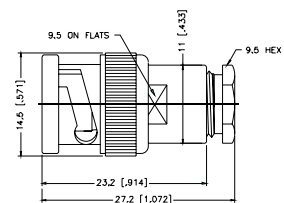

Assembly Instruction M - page 239

Right Angle Clamp Plug - Standard Cable

| P.N. | Cable Group | Pit. | Ins. | Imp. | Crimp Tool |
|--------------------|-------------|--------|--------|------|------------|
| Brass Shell | | | | | |
| B1142E1-ND3G-1-50 | 01 | Nickel | Delrin | 50 | N/A |
| B1142E1-ND3G-3-50 | 03 | Nickel | Delrin | 50 | N/A |
| B1142E1-ND3G-3-75 | 03 | Nickel | Delrin | 75 | N/A |

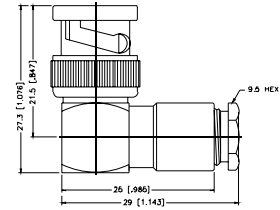
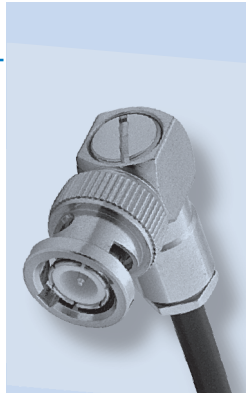

Assembly Instruction M - page 239

Straight Clamp Jack - Captive contact - Standard Cable

| P.N. | Cable Group | Pit. | Ins. | Imp. | Crimp Tool |
|--------------------|-------------|--------|--------|------|------------|
| B6141A1-NT3G-1-50 | 01 | Nickel | Teflon | 50 | N/A |
| B6141A1-NT3G-3-50 | 03 | Nickel | Teflon | 50 | N/A |
| B6141A1-NT3G-3-75 | 03 | Nickel | Teflon | 75 | N/A |
| B6141A2-NT3G-7A-50 | 07A | Nickel | Teflon | 50 | N/A |

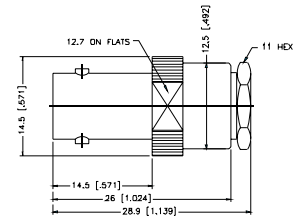
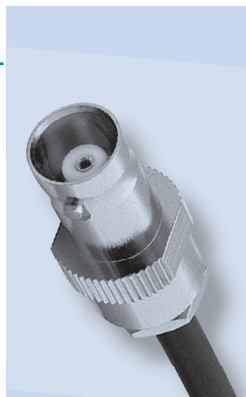

Assembly Instruction N - page 240

Bulkhead Clamp Jack - Captive Contact - Flexible Cable

| P.N. | Cable Group | Pit. | Ins. | Imp. | Crimp Tool |
|-------------------|-------------|--------|--------|------|------------|
| B6441A2-NT3G-1-50 | 01 | Nickel | Teflon | 50 | N/A |

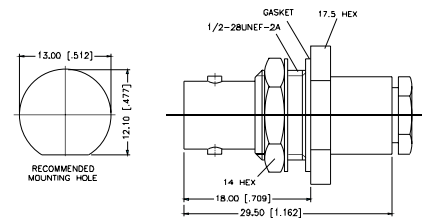

Assembly Instruction N - page 240

Twist-On Plug - Standard Cable

| P.N. | Cable Group | Pit. | Ins. | Imp. | Crimp Tool |
|--------------------|-------------|--------|--------|------|------------|
| Brass Shell | | | | | |
| B1131A1-ND3G-1-50 | 01 | Nickel | Delrin | 50 | N/A |
| B1131A1-ND3G-3-50 | 03 | Nickel | Delrin | 50 | N/A |
| B1131A1-ND3G-3-75 | 03 | Nickel | Delrin | 75 | N/A |
| B1131A1-ND3G-8-50 | 08 | Nickel | Delrin | 50 | N/A |

Remark: Only for solid center conductor cable

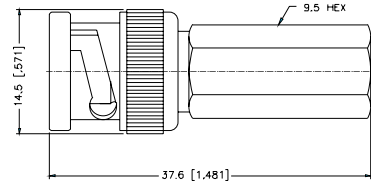
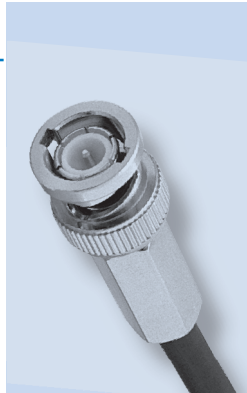

Assembly Instruction O - page 241

Twist-On Jack - Standard Cable

| P.N. | Cable Group | Pit. | Ins. | Imp. | Crimp Tool |
|-------------------|-------------|--------|--------|------|------------|
| B6131A1-ND3G-1-50 | 01 | Nickel | Delrin | 50 | N/A |
| B6131A1-ND3G-3-50 | 03 | Nickel | Delrin | 50 | N/A |

Remark: Only for solid center conductor cable

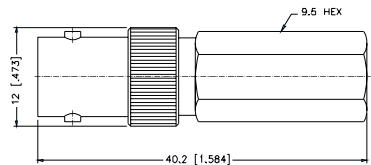
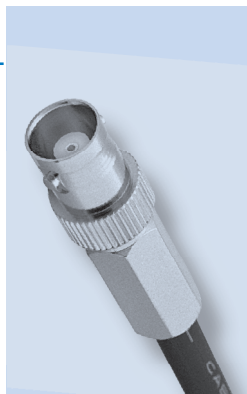

Assembly Instruction O - page 241

Wedge compression Plug - Standard Cable

| P.N. | Cable Group | Pit. | Ins. | Imp. | Crimp Tool |
|--------------------|-------------|--------|--------|------|------------|
| Brass Shell | | | | | |
| B1141G1-ND3G-1-50 | 01 | Nickel | Delrin | 50 | N/A |
| B1141G1-ND3G-3-50 | 03 | Nickel | Delrin | 50 | N/A |
| B1141G1-ND3G-3-75 | 03 | Nickel | Delrin | 75 | N/A |

Remark: With wedge pin

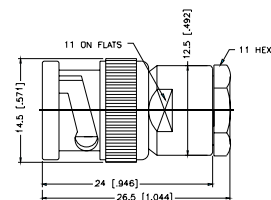

Assembly Instruction P - page 242

Wedge Compression Jack - Standard cable

| P.N. | Cable Group | Pit. | Ins. | Imp. | Crimp Tool |
|-------------------|-------------|--------|--------|------|------------|
| B6141G1-NT3G-1-50 | 01 | Nickel | Teflon | 50 | N/A |
| B6141G1-NT3G-3-50 | 03 | Nickel | Teflon | 50 | N/A |
| B6141G1-NT3G-3-75 | 03 | Nickel | Teflon | 75 | N/A |

Remark: With wedge contact

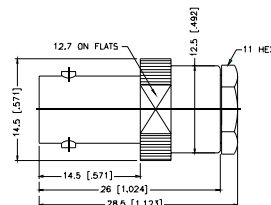
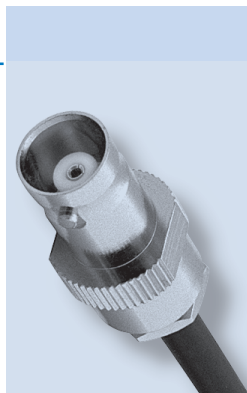

Assembly Instruction P - page 242

Bulkhead Receptacle Plug - Front Mount

| P.N. | Cable Group | Pit. | Ins. | Imp. | Crimp Tool |
|--------------------|-------------|--------|--------|------|------------|
| Brass Shell | | | | | |
| B1351Q1-ND3G-50 | N/A | Nickel | Delrin | 50 | N/A |
| B1351Q2-NT3G-75 | N/A | Nickel | Teflon | 75 | N/A |

Remark: 4.5 [.177] Max. panel thickness

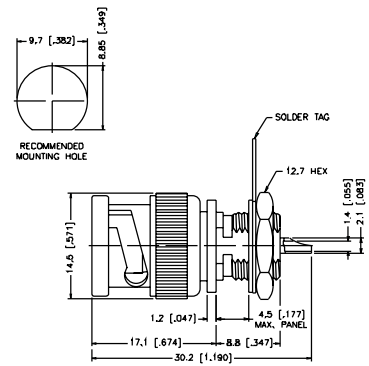
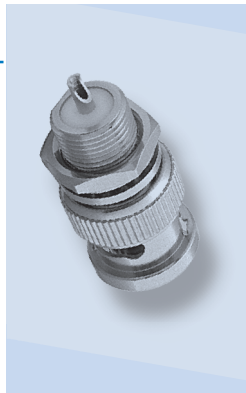

Bulkhead Receptacle Jack - Front Mount

| P.N. | Cable Group | Pit. | Ins. | Imp. | Crimp Tool |
|--|-------------|--------|--------|------|------------|
| L1 = 3.2 [.126] Max. panel thickness, L = 26.7 [1.05] | | | | | |
| B6351B1-ND3G-50 | N/A | Nickel | Delrin | 50 | N/A |
| B6351B1-NT3G-50 | N/A | Nickel | Teflon | 50 | N/A |
| B6351B1-ND3G-75 | N/A | Nickel | Delrin | 75 | N/A |
| L1 = 6.5 [.256] Max. panel thickness, L = 30.0 [1.18] | | | | | |
| B6351B2-ND3G-50 | N/A | Nickel | Delrin | 50 | N/A |
| B6351B2-ND3G-75 | N/A | Nickel | Delrin | 75 | N/A |

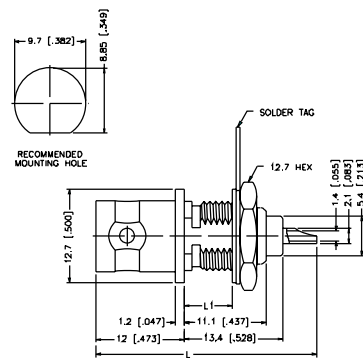
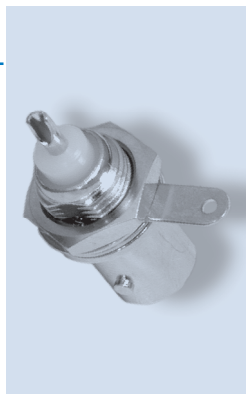

Bulkhead Receptacle Isolated Jack - Front Mount

| P.N. | Cable Group | Pit. | Ins. | Imp. | Crimp Tool |
|-------------------|-------------|--------|------|------|------------|
| B6651B1-NNYL3G-50 | N/A | Nickel | ABS | 50 | N/A |
| B6651B1-NNYL3G-75 | N/A | Nickel | ABS | 75 | N/A |

Remark: 3.2 [.126] Max. panel thickness

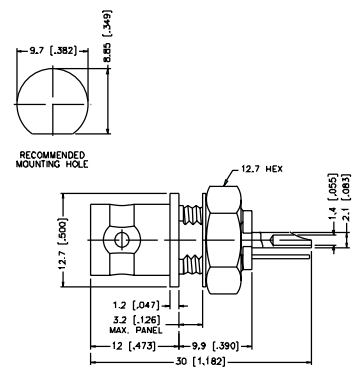
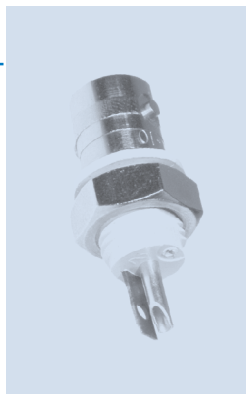

Bulkhead Receptacle Isolated Jack - Rear Mount

| P.N. | Cable Group | Pit. | Ins. | Imp. | Crimp Tool |
|---------------------|-------------|--------|--------|------|------------|
| B675100-001-NT3G-50 | N/A | Nickel | Teflon | 50 | N/A |

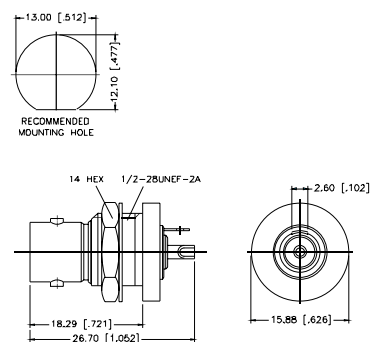
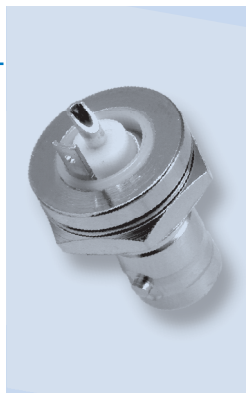

Bulkhead Receptacle - Push Fit

| P.N. | Cable Group | Pit. | Ins. | Imp. | Crimp Tool |
|------------------|-------------|--------|--------|------|------------|
| B6051A2-NT30G-50 | N/A | Nickel | Teflon | 50 | N/A |

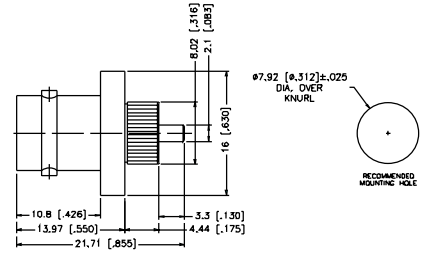
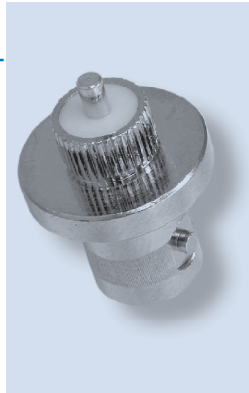

| P.N. | Cable Group | Pit. | Ins. | Imp. | Crimp Tool |
|------------------|-------------|--------|--------|------|------------|
| B6051A1-NT50G-50 | N/A | Nickel | Teflon | 50 | N/A |

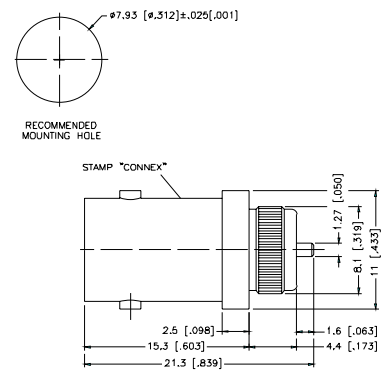

Panel Receptacle Jack

| P.N. | Cable Group | Pit. | Ins. | Imp. | Crimp Tool |
|---|-------------|--------|--------|------|------------|
| B6551A1-NT3G-50 | N/A | Nickel | Teflon | 50 | N/A |
| B6551A1-NT3G-75 | N/A | Nickel | Teflon | 75 | N/A |
| B6551A9-001-NT3G-50 Flush Rear 4-40 Screws | N/A | Nickel | Teflon | 50 | N/A |

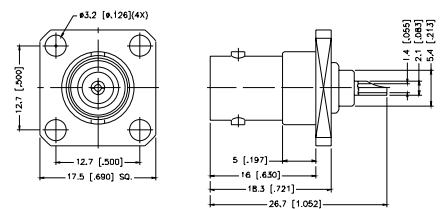
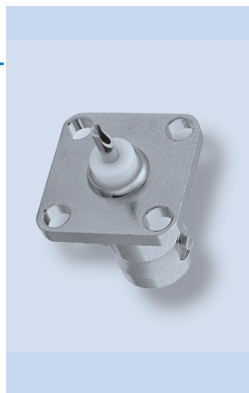

Panel Receptacle Plug

| P.N. | Cable Group | Pit. | Ins. | Imp. | Crimp Tool |
|-----------------|-------------|--------|--------|------|------------|
| B1551A1-NT3G-50 | N/A | Nickel | Teflon | 50 | N/A |

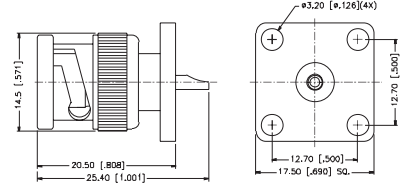
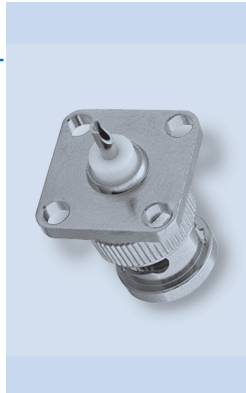

Panel Receptacle Jack - Exposed TFE Type

| P.N. | Cable Group | Pit. | Ins. | Imp. | Crimp Tool |
|-----------------------|-------------|--------|--------|------|------------|
| B6551E1-002-NT30G-50 | N/A | Nickel | Teflon | 50 | N/A |
| B6551E1-002-ST30GA-50 | N/A | Silver | Teflon | 50 | N/A |

Note: Contact Amphenol for other lengths availability

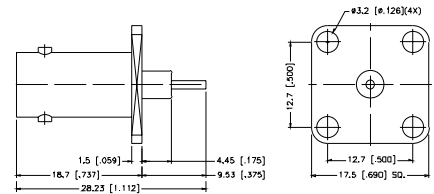
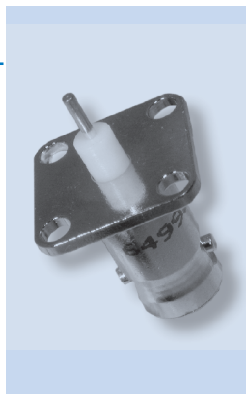

Panel Receptacle - Exposed Teflon - Gasket Seal

| P.N. | Cable Group | Pit. | Ins. | Imp. | Crimp Tool |
|---------------------|-------------|--------|--------|------|------------|
| B6551E1-001-NT3G-50 | N/A | Nickel | Teflon | 50 | N/A |

Note: Contact Amphenol for other lengths availability

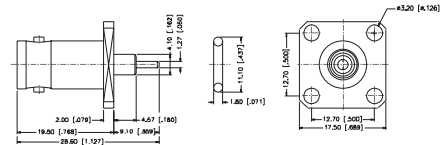
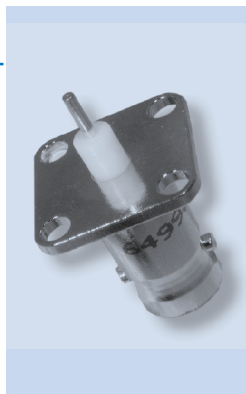

Straight P.C. Board Mount Jack - Four Legs

| P.N. | Cable Group | Plt. | Ins. | Imp. | Crimp Tool |
|-----------------|-------------|--------|--------|------|------------|
| B6251C1-NT3G-50 | N/A | Nickel | Teflon | 50 | N/A |
| B6251C1-NT3G-75 | N/A | Nickel | Teflon | 75 | N/A |

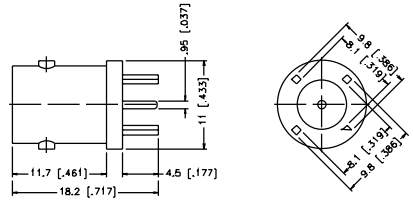
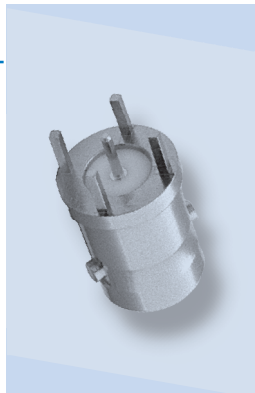

| P.N. | Cable Group | Plt. | Ins. | Imp. | Crimp Tool |
|------------------|-------------|--------|---------------|------|------------|
| B6251D1-NPB3G-50 | N/A | Nickel | PBT Polyester | 50 | N/A |
| B6251D1-NPB3G-75 | N/A | Nickel | PBT Polyester | 75 | N/A |

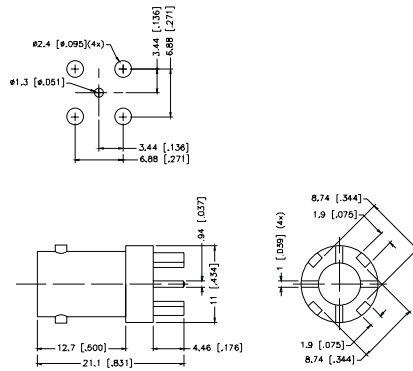
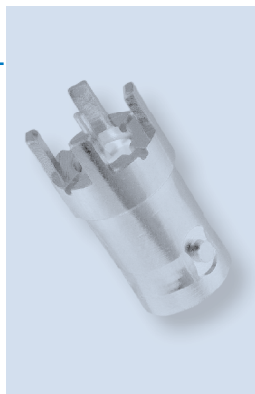

| P.N. | Cable Group | Plt. | Ins. | Imp. | Crimp Tool |
|-----------------------------------|-------------|--------|--------|------|------------|
| B6251C1-003-NT3G-50 | N/A | Nickel | Teflon | 50 | N/A |
| B6251C1-004-NT3G-50 Waterproof | N/A | Nickel | Teflon | 50 | N/A |

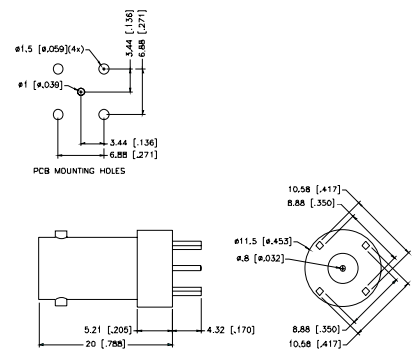
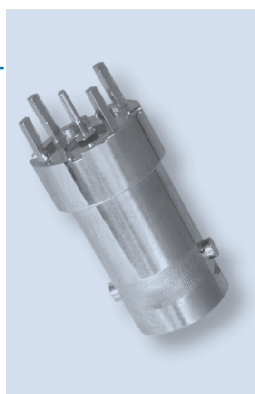

| P.N. | Cable Group | Plt. | Ins. | Imp. | Crimp Tool |
|---------------------|-------------|--------|--------|------|------------|
| B625100-009-NT3G-50 | N/A | Nickel | Teflon | 50 | N/A |
| B625100-009-NT3G-75 | N/A | Nickel | Teflon | 75 | N/A |

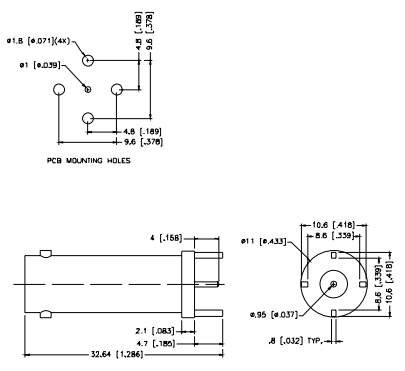
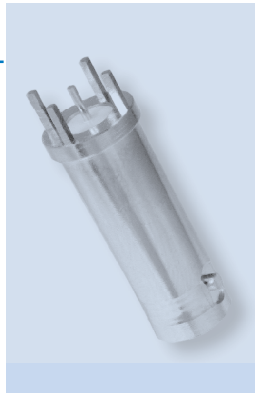

Straight P.C. Board Mount Jack - Three Legs

| P.N. | Cable Group | Pit. | Ins. | Imp. | Crimp Tool |
|-----------------|-------------|--------|--------|------|------------|
| B6251E1-NT3G-50 | N/A | Nickel | Teflon | 50 | N/A |

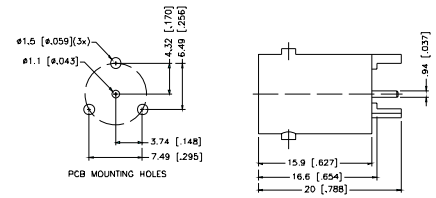
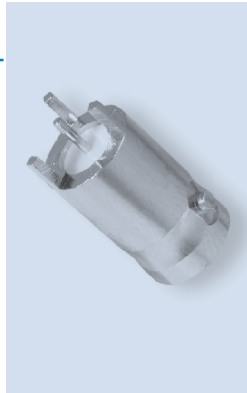

Straight P.C. Board Mount Jack - Four Legs

| P.N. | Cable Group | Pit. | Ins. | Imp. | Crimp Tool |
|-----------------------|-------------|--------|--------|------|------------|
| B6251C1-005-NT30G-75T | N/A | Nickel | Teflon | 75 | N/A |

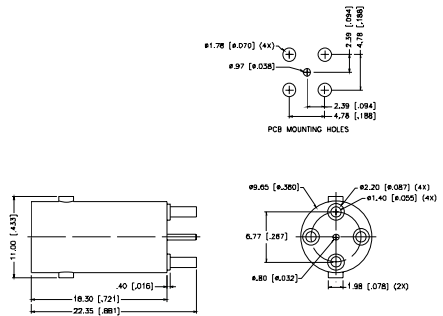
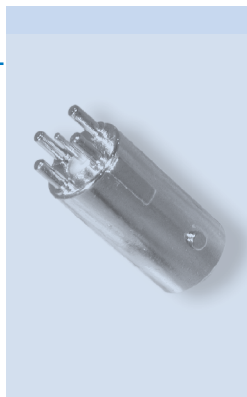

| P.N. | Cable Group | Pit. | Ins. | Imp. | Crimp Tool |
|-----------------|-------------|--------|--------|------|------------|
| B6251F1-NT3G-50 | N/A | Nickel | Teflon | 50 | N/A |
| B6251F1-NT3G-75 | N/A | Nickel | Teflon | 75 | N/A |

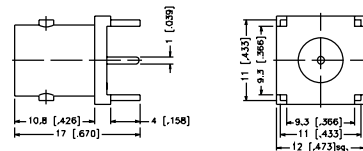
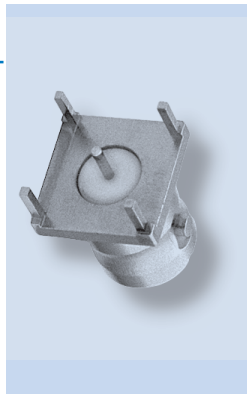

| P.N. | Cable Group | Pit. | Ins. | Imp. | Crimp Tool |
|---------------------|-------------|--------|--------|------|------------|
| B625100-008-NT3G-50 | N/A | Nickel | Teflon | 50 | N/A |
| B625100-005-NT3G-75 | N/A | Nickel | Teflon | 75 | N/A |

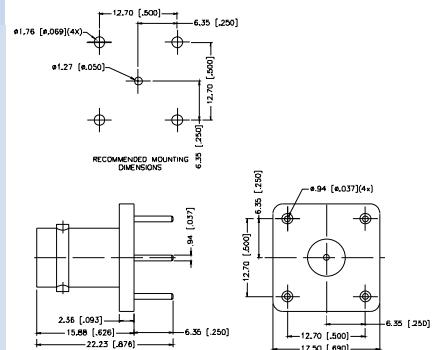
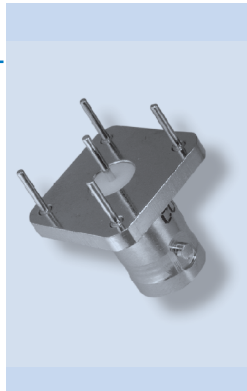

Straight P.C. Board Edge mount Jack - End Launch

| P.N. | Cable Group | Plt. | Ins. | Imp. | Crimp Tool |
|---------------------|-------------|--------|--------|------|------------|
| B6251Q1-001-NT3G-50 | N/A | Nickel | Teflon | 50 | N/A |
| B6251Q1-001-NT3G-75 | N/A | Nickel | Teflon | 75 | N/A |

Square Flange

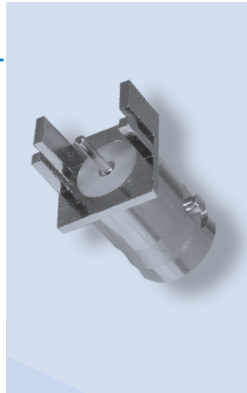

B6251Q1-001-NT3G-50

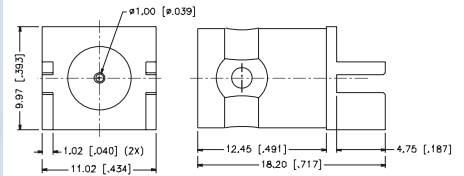

| | | | | | |
|---------------------|-----|--------|--------|----|-----|
| B625100-006-NT3G-50 | N/A | Nickel | Teflon | 50 | N/A |
| B625100-006-NT3G-75 | N/A | Nickel | Teflon | 75 | N/A |

Round Flange

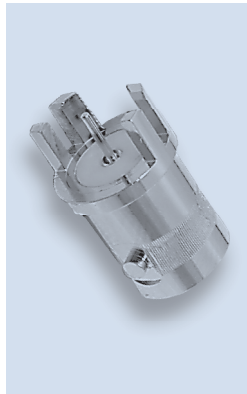

B625100-006-NT3G-50

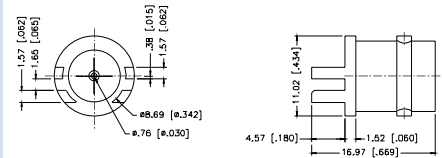

Bulkhead Vertical P.C. Board Receptacle - End Launch

| P.N. | Cable Group | Plt. | Ins. | Imp. | Crimp Tool |
|---------------------|-------------|--------|--------|------|------------|
| B6351B1-004-NT3G-50 | N/A | Nickel | Teflon | 50 | N/A |

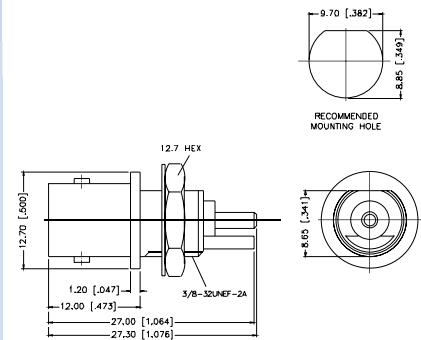

Commercial Straight P.C. Board Mount Jack

| P.N. | Cable Group | Pit. | Ins. | Imp. | Crimp Tool |
|----------------------|-------------|--------|---------------|------|------------|
| White Housing | | | | | |
| B6251G1-NPP3G-50 | N/A | Nickel | Polypropylene | 50 | N/A |
| B6251G1-NPP3G-75T | N/A | Nickel | Polypropylene | 75 | N/A |
| Black Housing | | | | | |
| B6251G2-NPP3G-50 | N/A | Nickel | Polypropylene | 50 | N/A |
| B6251G2-NPP3G-75T | N/A | Nickel | Polypropylene | 75 | N/A |

Remark: Add L to part number for Locking Legs

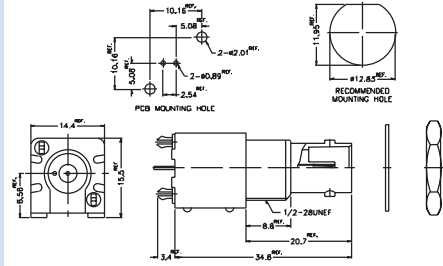
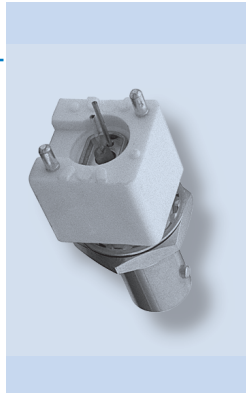

Commercial Straight P.C. Board Mount Jack - Metal Body

| P.N. | Cable Group | Pit. | Ins. | Imp. | Crimp Tool |
|-------------------|-------------|--------|---------------|------|------------|
| Diecast | | | | | |
| B6251G3-NPP3G-50 | N/A | Nickel | Polypropylene | 50 | N/A |
| B6251G3-NPP3G-75T | N/A | Nickel | Polypropylene | 75 | N/A |

Note: Connectors are shipped with lock nut and washer

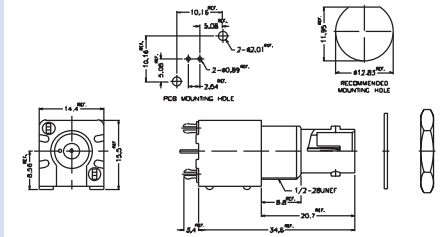
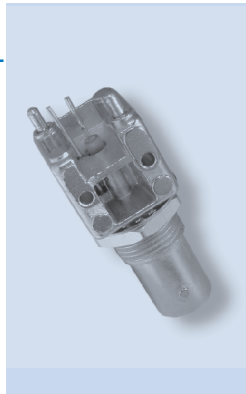

Commercial Right Angle P.C. Board Mount Jack

| P.N. | Cable Group | Pit. | Ins. | Imp. | Crimp Tool |
|---|-------------|--------|---------------|------|------------|
| High Profile, 15.88 [.625] White | | | | | |
| B6252H5-NPP3G-50 | N/A | Nickel | Polypropylene | 50 | N/A |
| B6252H5-NPP3G-75T | N/A | Nickel | Polypropylene | 75 | N/A |
| High Profile, 15.88 [.625] Black | | | | | |
| B6252H6-NPP3G-50 | N/A | Nickel | Polypropylene | 50 | N/A |
| B6252H6-NPP3G-75T | N/A | Nickel | Polypropylene | 75 | N/A |
| Low Profile, 13.1 [.516] White | | | | | |
| B6252H7-NPP3G-50 | N/A | Nickel | Polypropylene | 50 | N/A |
| B6252H7-NPP3G-75T | N/A | Nickel | Polypropylene | 75 | N/A |
| Low Profile, 13.1 [.516] Black | | | | | |
| B6252H8-NPP3G-50 | N/A | Nickel | Polypropylene | 50 | N/A |
| B6252H8-NPP3G-75T | N/A | Nickel | Polypropylene | 75 | N/A |

Note: Connectors are shipped with lock nut and washer

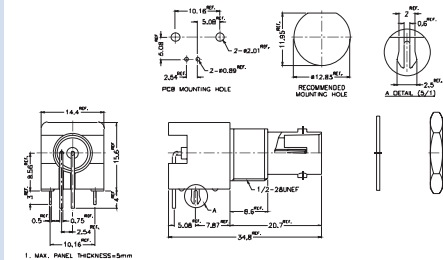
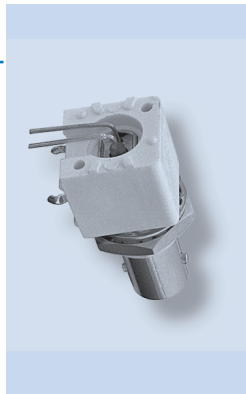

Commercial Right Angle P.C. Board Mount Jack - Metal Body

| P.N. | Cable Group | Pit. | Ins. | Imp. | Crimp Tool |
|-----------------------------------|-------------|--------|---------------|------|------------|
| Diecast | | | | | |
| High Profile, 15.88 [.625] | | | | | |
| B6252HA-NPP3G-50 | N/A | Nickel | Polypropylene | 50 | N/A |
| B6252HA-NPP3G-75T | N/A | Nickel | Polypropylene | 75 | N/A |
| Low Profile, 13.1 [.516] | | | | | |
| B6252HB-NPP3G-50 | N/A | Nickel | Polypropylene | 50 | N/A |
| B6252HB-NPP3G-75T | N/A | Nickel | Polypropylene | 75 | N/A |
| UL approved UL no. E161813 | | | | | |
| High Profile, 15.88 [.625] | | | | | |
| B6252HC-NPP3G-50 | N/A | Nickel | Polypropylene | 50 | N/A |
| B6252HC-NPP3G-75T | N/A | Nickel | Polypropylene | 75 | N/A |
| with fork legs | | | | | |
| Low Profile, 13.1 [.516] | | | | | |
| B6252HD-NPP3G-50 | N/A | Nickel | Polypropylene | 50 | N/A |
| B6252HD-NPP3G-75T | N/A | Nickel | Polypropylene | 75 | N/A |
| with fork legs | | | | | |

Note: Connectors are shipped with lock nut and washer

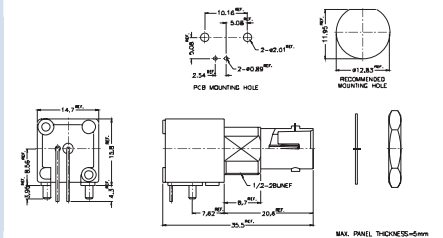
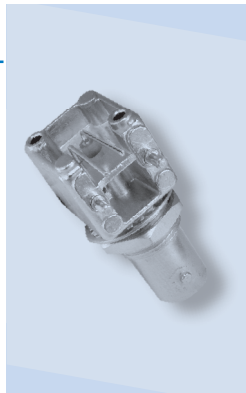

Dual port PCB Mount Receptacle Hook

| P.N. | Cable Group | Pit. | Ins. | Imp. | Crimp Tool |
|----------------------------------|-------------|--------|---------------|------|------------|
| B705000-NPB3G-75 Plastic body | N/A | Nickel | Polypropylene | 75 | N/A |
| B705001-NPB3G-75 Metal body | N/A | Nickel | Polypropylene | 75 | N/A |

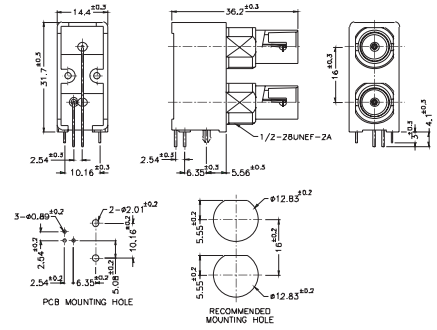
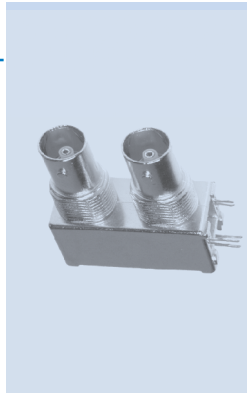

Press-Fit PC Board Receptacle Jack

| P.N. | Cable Group | Pit. | Ins. | Imp. | Crimp Tool |
|------------------|-------------|--------|--------|------|------------|
| B6251PF-NT10G-50 | N/A | Nickel | Teflon | 50 | N/A |

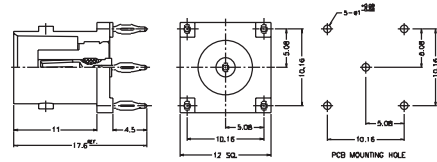
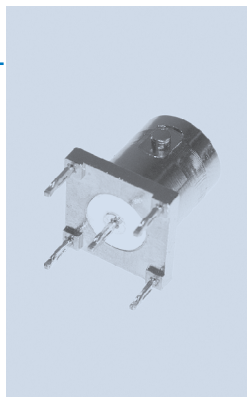

Jack-to-Jack Bulkhead Adapter

| P.N. | Cable Group | Pit. | Ins. | Imp. | Crimp Tool |
|-----------------|-------------|--------|--------|------|------------|
| B7471A1-ND3G-50 | N/A | Nickel | Delrin | 50 | N/A |
| B7471A1-ND3G-75 | N/A | Nickel | Delrin | 75 | N/A |

Remark: 8.0 mm [.315] Max. panel thickness, M55339/13-00492

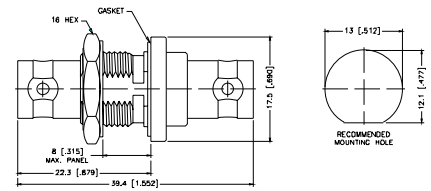
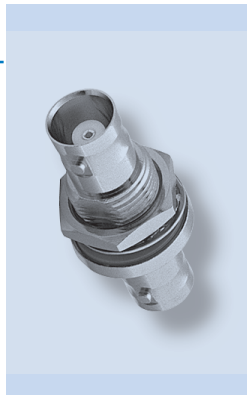

| P.N. | Cable Group | Pit. | Ins. | Imp. | Crimp Tool |
|-----------------|-------------|--------|--------|------|------------|
| B7471A2-ND3G-50 | N/A | Nickel | Delrin | 50 | N/A |
| B7471A2-ND3G-75 | N/A | Nickel | Delrin | 75 | N/A |

Remark: 7.0 mm [.276] Max. panel thickness, UG-492A

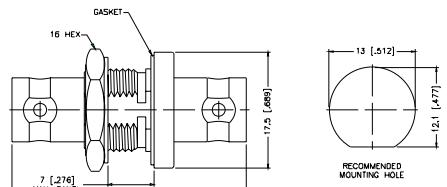
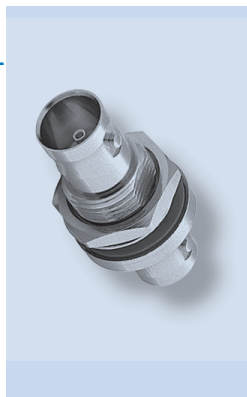

| P.N. | Cable Group | Pit. | Ins. | Imp. | Crimp Tool |
|-----------------|-------------|--------|--------|------|------------|
| B7471B1-ND3G-50 | N/A | Nickel | Delrin | 50 | N/A |
| B7471B1-ND3G-75 | N/A | Nickel | Delrin | 75 | N/A |

Remark: Without gasket, 5.5 mm [.217] Max. panel thickness

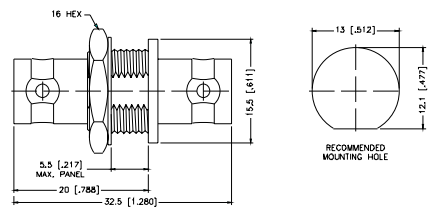

Jack-to-Plug Bulkhead Adapter - Push-On

| P.N. | Cable Group | Pit. | Ins. | Imp. | Crimp Tool |
|-----------------|-------------|--------|--------|------|------------|
| B5071A1-NT3G-75 | N/A | Nickel | Teflon | 75 | N/A |

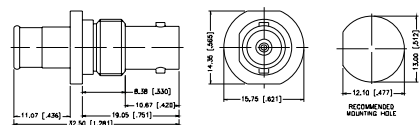

Jack-to-Jack Bulkhead - Isolated Adapter

| P.N. | Cable Group | Pit. | Ins. | Imp. | Crimp Tool |
|-----------------|-------------|--------|--------|------|------------|
| B7771B1-ND3G-50 | N/A | Nickel | Delrin | 50 | N/A |
| B7771B1-ND3G-75 | N/A | Nickel | Delrin | 75 | N/A |

Remark: With Isolated Bushing,
4.5 mm [.177] Max. panel thickness

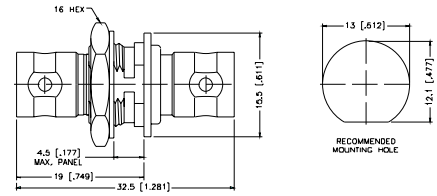
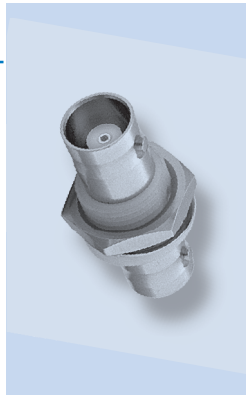

| P.N. | Cable Group | Pit. | Ins. | Imp. | Crimp Tool |
|-----------------|-------------|--------|--------|------|------------|
| B7771B3-ND3G-50 | N/A | Nickel | Delrin | 50 | N/A |
| B7771B3-ND3G-75 | N/A | Nickel | Delrin | 75 | N/A |

Remark: 5.5 mm [.217] Max. panel thickness

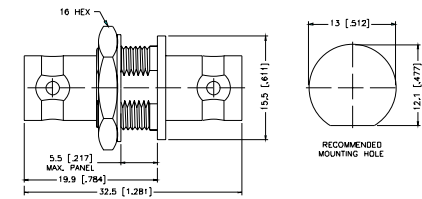
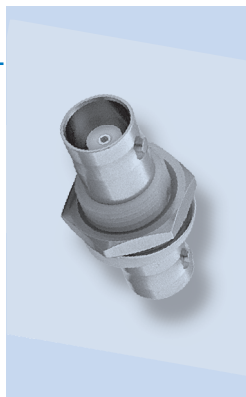

Jack-to-Jack Adapter

| P.N. | Cable Group | Pit. | Ins. | Imp. | Crimp Tool |
|-----------------|-------------|--------|--------|------|------------|
| B7071A1-ND3G-50 | N/A | Nickel | Delrin | 50 | N/A |
| B7071A1-ND3G-75 | N/A | Nickel | Delrin | 75 | N/A |

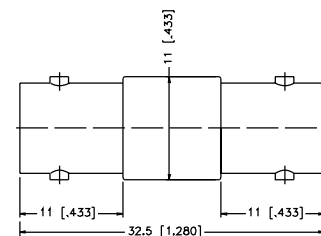

Plug-to-Plug Adapter

| P.N. | Cable Group | Pit. | Ins. | Imp. | Crimp Tool |
|----------------------|-------------|--------|--------|------|------------|
| Brass Shell | | | | | |
| B2071A2-ND3G-50 | N/A | Nickel | Delrin | 50 | N/A |
| B2071A2-ND3G-75 | N/A | Nickel | Delrin | 75 | N/A |
| Diecast Shell | | | | | |
| B2071B2-002-ND3G-50 | N/A | Nickel | Delrin | 50 | N/A |
| B2071B2-002-ND3G-75 | N/A | Nickel | Delrin | 75 | N/A |

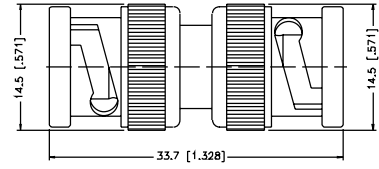
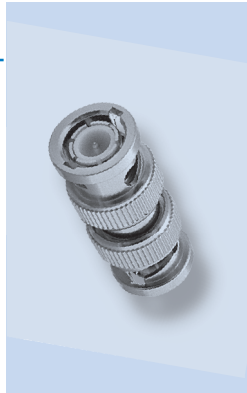

Right Angle Adapter - Plug-to-Jack

| P.N. | Cable Group | Pit. | Ins. | Imp. | Crimp Tool |
|----------------------|-------------|--------|--------|------|------------|
| Brass Shell | | | | | |
| B5072A1-ND3G-50 | N/A | Nickel | Delrin | 50 | N/A |
| B5072A1-ND3G-75 | N/A | Nickel | Delrin | 75 | N/A |
| Diecast Shell | | | | | |
| B5072B1-001-ND3G-50 | N/A | Nickel | Delrin | 50 | N/A |
| B5072B1-001-ND3G-75 | N/A | Nickel | Delrin | 75 | N/A |

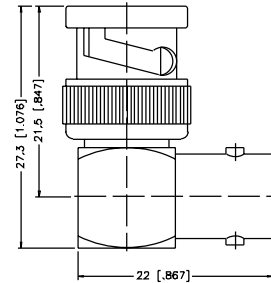
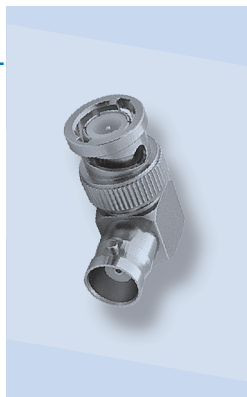

Tee Adapter - Jack-to-Jack-to-Jack

| P.N. | Cable Group | Pit. | Ins. | Imp. | Crimp Tool |
|-----------------|-------------|--------|--------|------|------------|
| B8073A1-ND3G-50 | N/A | Nickel | Delrin | 50 | N/A |
| B8073A1-ND3G-75 | N/A | Nickel | Delrin | 75 | N/A |

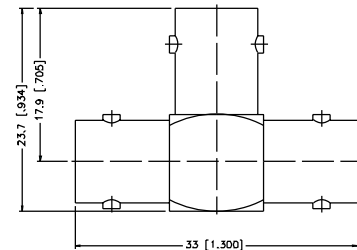
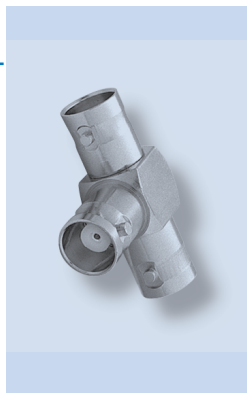

Tee Adapter - Jack-to-Plug-to-Jack

| P.N. | Cable Group | Pit. | Ins. | Imp. | Crimp Tool |
|-----------------|-------------|--------|--------|------|------------|
| B9073D1-ND3G-50 | N/A | Nickel | Delrin | 50 | N/A |
| B9073D1-ND3G-75 | N/A | Nickel | Delrin | 75 | N/A |

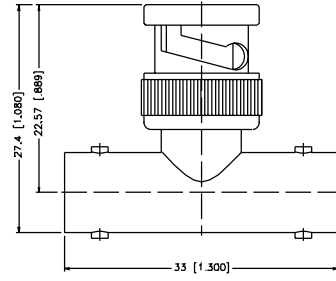
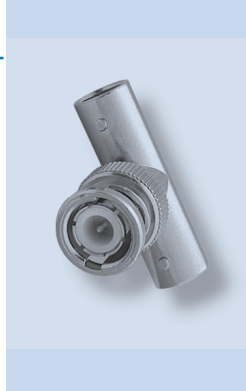

Tee Adapter - Jack-to-Jack-to-Plug

| P.N. | Cable Group | Pit. | Ins. | Imp. | Crimp Tool |
|--------------|-------------|--------|--------|------|------------|
| OS-7078-NDG | N/A | Nickel | Delrin | 50 | N/A |
| OS-7078-NT3G | N/A | Nickel | Teflon | 50 | N/A |

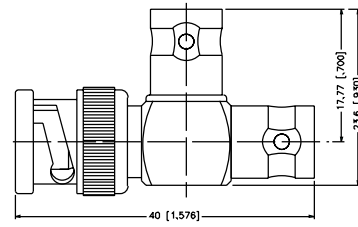
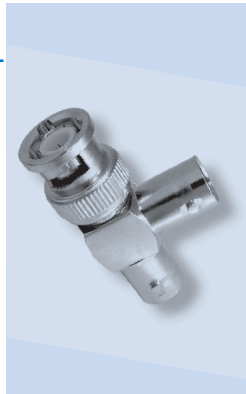

Terminator Plug

| P.N. | Cable Group | Pit. | Ins. | Imp. | Crimp Tool |
|--|-------------|--------|--------|------|------------|
| B1004A1-ND3G-50R-0.05-0.5W | N/A | Nickel | Delrin | 50 | N/A |
| B1004A1-NT3G-50R-0.5W | N/A | Nickel | Teflon | 50 | N/A |
| B1004A1-ND3G-75R-0.05-1W | N/A | Nickel | Delrin | 75 | N/A |
| B1004A1-NT3G-75R-0.05-1W | N/A | Nickel | Teflon | 75 | N/A |
| B1004A1-ND3G-93R-0.05-1W | N/A | Nickel | Delrin | 93 | N/A |
| B1004A1-NT3G-93R-0.05-1W | N/A | Nickel | Teflon | 93 | N/A |
| B1004A3-NT3G-50R High Performance | N/A | Nickel | Teflon | 50 | N/A |
| B1004A3-NT3G-75R-0.01-0.5W High Performance | N/A | Nickel | Teflon | 75 | N/A |

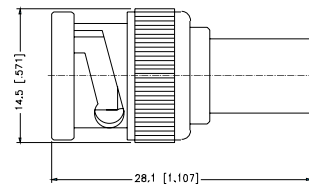
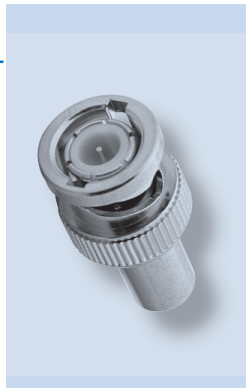

Terminator Jack

| P.N. | Cable Group | Pit. | Ins. | Imp. | Crimp Tool |
|--------------------------|-------------|--------|--------|------|------------|
| B6004A1-NT3G-50R-0.05-1W | N/A | Nickel | Teflon | 50 | N/A |
| B6004A1-NT3G-75R-0.05-1W | N/A | Nickel | Teflon | 75 | N/A |
| B6004A1-001-ND3G | N/A | Nickel | Delrin | 500 | N/A |

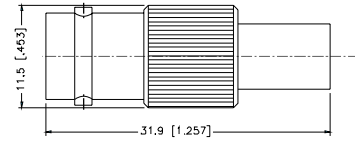
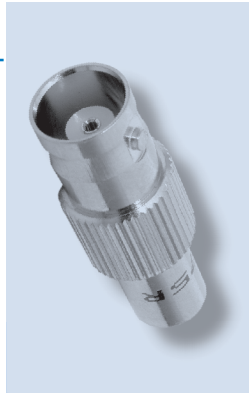

Male Cap & Chain

| P.N. | Cable Group | Pit. | Ins. | Imp. | Crimp Tool |
|--|-------------|--------|------|------|------------|
| B1005A1-N With Chain Remark: Chain length 100 mm | N/A | Nickel | N/A | N/A | N/A |
| B1005A1-001-N No Chain | N/A | Nickel | N/A | N/A | N/A |

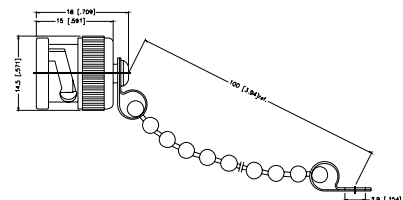

Male Shorting Cap

| P.N. | Cable Group | Pit. | Ins. | Imp. | Crimp Tool |
|----------------------------|-------------|--------|--------|------|------------|
| B1007A1-NT3G No Chain | N/A | Nickel | Teflon | N/A | N/A |
| B1007A2-NT3G With Chain | N/A | Nickel | Teflon | N/A | N/A |

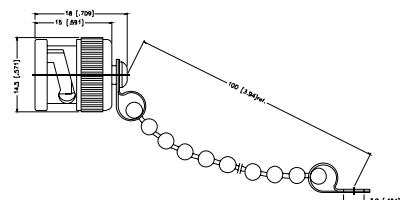

X-ON Electronics

Largest Supplier of Electrical and Electronic Components

Click to view similar products for [RF Connectors](#) / [Coaxial Connectors](#) category:

Click to view products by [Amphenol](#) manufacturer:

Other Similar products are found below :

[R125315120](#) [8915-1511-000](#) [89674-0827](#) [5916-1103-603](#) [0106-001-000](#) [6-0001-3](#) [6001-7071-019](#) [6002-7051-003](#) [6002-7551-202](#) [6059674-1](#) [619550-1](#) [630059-000](#) [M39012/25-0021](#) [M39012/79-3008](#) [M39030/3-01N](#) [M39030/3-03N](#) [M3933/25-29N](#) [M3933/25-36N](#) [6500-7071-046](#) [6501-1071-002](#) [M83723/72W24576](#) [M83723/72W2457N](#) [6769](#) [CX050L2AQ](#) [7002-1541-010](#) [7003-1572-002](#) [7004-1512-000](#) [7009-1511-004](#) [7010-1511-000](#) [7029-1511-060](#) [7101-1541-010](#) [7101-1571-002](#) [7105-1521-002](#) [7145-1521-002](#) [7209-1511-011](#) [7210-1511-012](#) [7210-1511-015](#) [7210-1511-019](#) [7210-1511-040](#) [7225-1512-050](#) [7242-1511-000](#) [73137-5015](#) [73251-0111](#) [73251-0672](#) [73276-1501](#) [73366-0013](#) [73404-2300](#) [73413-6080](#) [734151610](#) [73415-5721](#)