

THIS DOCUMENT IS SUBJECT TO CHANGE WITHOUT NOTICE. IT IS CONFIDENTIAL AND A PROPERTY OF AMPHENOL LTW. DISCLOSURE TO THIRD PARTY HAS TO BE AUTHORIZED BY AMPHENOL LTW.

REV.	ECN NO.	DATE	SIGN	DESCRIPTION
A		2016/11/03	Victor Hung	Change Rev.01 To Rev.A

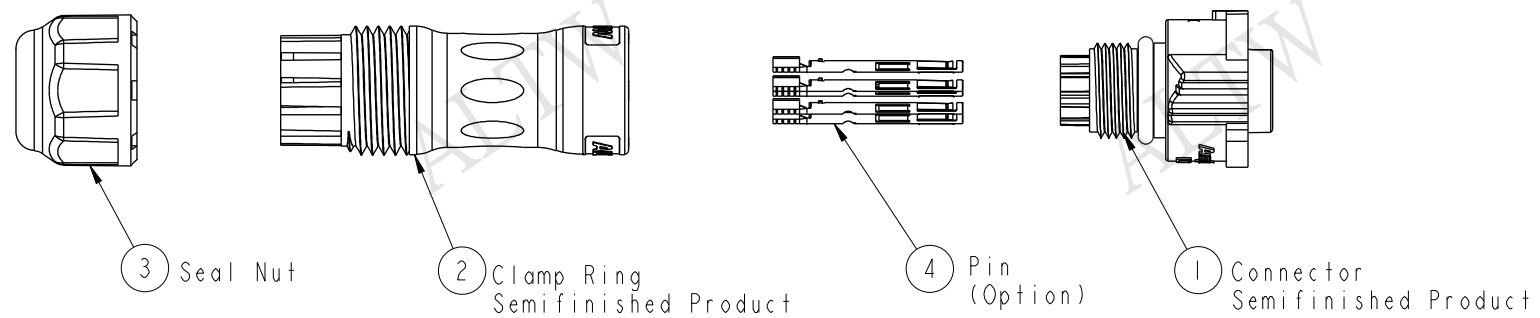

Material Specification:

- * Connector: Thermoplastic, Black.
- * Terminal: Copper Alloy, Gold Plated.
- * Gasket & O-Ring: Rubber.
- * UL Rated: UL 94V-0, fl.
- * RoHS Compliant.

Electrical Specification:

- * Contact Resistance: 10mΩ Max.
- * Insulation Resistance: 100MΩ Min.
- * Dielectric Withstand Voltage: 1,600 Vac.

Mechanical Specification:

- * Durability: 1000 Cycles.
- * Tensile strength: 10 kgf.
- * Wire Conductor:
 - 5A: 22AWG~20AWG
 - 10A: 18AWG~16AWG
- * Wire Insulation OD:
 - 5A: 1.9mm Max.
 - 10A: 2.7mm Max.
- * Torque Force for Clamp Ring: 6~8 kgf-cm
- * Torque Force for Seal Nut: 6~8 kgf-cm

Environmental Specification:

- * Waterproof Rating: IP68(Mated, 1M/24 Hours)
- * Temperature Range: -40°C to 105°C.
- * Salt Spray: Mated, 1000 Hours.
- * Safety Compliance: UL 1977.

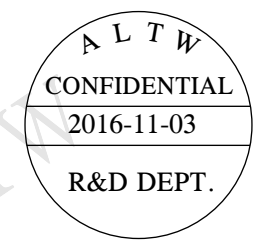
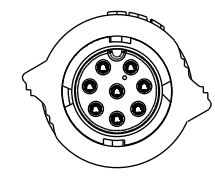
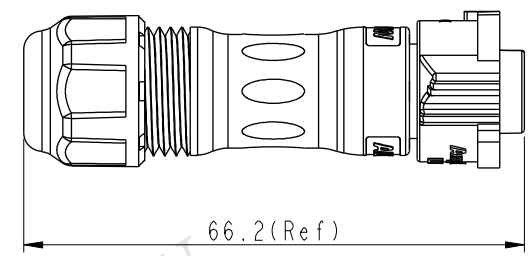
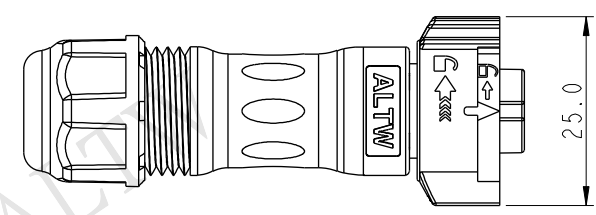

UNIT:mm			TITLE X-Lok B-Size Field Installable Cable Type F Conn		
TOLERANCE ±0.5 mm			SCALE 8:5	SIZE A4	SHEET 1 OF 2
REV. A	WC-REV. A.3	QC: Inspection item			

Amphenol LTW
安費諾亮泰企業股份有限公司

ITEM NO	DRAWN BY Victor Hung	DATE 2016/11/03
DWG NO BX-0XBFXA-QL8XX0	CHECKED BY Wes Fan	DATE 2016/11/03
CUSTOMER ALTW	APPROVED BY Kevin Hu	DATE 2016/11/03

THIS DOCUMENT IS SUBJECT TO CHANGE WITHOUT NOTICE. IT IS CONFIDENTIAL AND A PROPERTY OF Amphenol LTW. DISCLOSURE TO THIRD PARTY HAS TO BE AUTHORIZED BY Amphenol LTW.

Ordering Information:

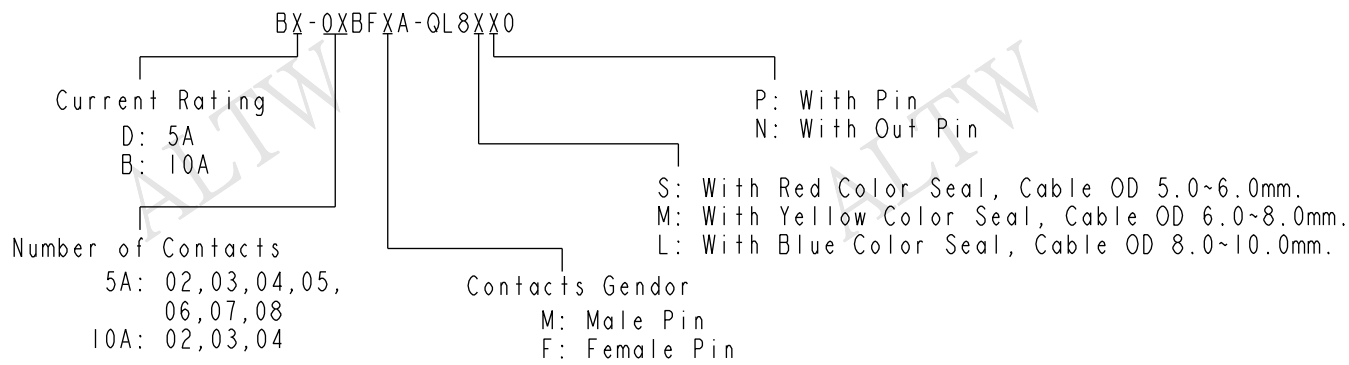

Mating Connector:
 Overmolded with Cable: BX-0XAMXM-QL8XXX
 Receptacle: BX-0XXMXS-QX8001
 Field Installable: BX-0XBMXA-QL8XX0

Tool Part No:
 ASST-C-XXA-W-A

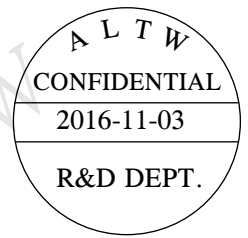

Pin Assignments Front View	10A ; 300Vac/Vdc 2 Contacts(02)	10A ; 300Vac/Vdc 3 Contacts(03)	10A ; 300Vac/Vdc 4 Contacts(04)	5A ; 300Vac/Vdc 2 Contacts(02)	5A ; 300Vac/Vdc 3 Contacts(03)	5A ; 300Vac/Vdc 4 Contacts(04)	5A ; 300Vac/Vdc 5 Contacts(05)	5A ; 300Vac/Vdc 6 Contacts(06)	5A ; 300Vac/Vdc 7 Contacts(07)	5A ; 300Vac/Vdc 8 Contacts(08)
Male Pin										
Female Pin										

UNIT:mm 	TITLE X-Lok B-Size Field Installable Cable Type F Conn			Amphenol LTW 安費諾亮泰企業股份有限公司	ITEM NO	DRAWN BY Victor Hung	DATE 2016/11/03		
	TOLERANCE ±0.5 mm		SCALE 8:5		SIZE A4	SHEET 2 OF 2	DWG NO BX-0XBFXA-QL8XX0	CHECKED BY Wes Fan	DATE 2016/11/03
	REV. A	WC-REV. A.3	QC: Inspection item		CUSTOMER ALTW	APPROVED BY Kevin Hu	DATE 2016/11/03		

X-ON Electronics

Largest Supplier of Electrical and Electronic Components

Click to view similar products for [Standard Circular Connector](#) category:

Click to view products by [Amphenol](#) manufacturer:

Other Similar products are found below :

[5M2530B10P](#) [600259N006](#) [600273N007](#) [6134-336-13149](#) [6134-337-11149](#) [6134-337-2390](#) [6134-341-17149](#) [6280-4SG-516](#) [6280-7SG-3DC](#)
[6290](#) [6291A](#) [66200A-10](#) [680-SMG](#) [681-PMG](#) [CXS3102A14S2P](#) [CXS3102A181S](#) [7251-6SG-300](#) [7271-6SG-300](#) [7282-3PG-300-CH3](#) [75-](#)
[474014-05S](#) [75-474618-01S](#) [75-474618-04P](#) [75-474618-04S](#) [799539-000](#) [MI8-SE](#) [805-005-07NF11-19PC](#) [805-005-07NF15-7PA](#) [8280-4PG-](#)
[516](#) [8280-7PG-519](#) [8282-5PG-519](#) [836783-1](#) [MP-4102-25P-C](#) [862256-1](#) [864019-2](#) [866857-1](#) [867865-1](#) [PT01SP-14-18P](#) [PT08P-14-5S](#)
[PTSF06SE-14-12S](#) [120-1833-000](#) [QCM019PC2DC012B](#) [1-2069279-1](#) [121583-0217](#) [121667-0020](#) [129591AU](#) [1000B BULK](#) [RD10A16-19-](#)
[P6CS051/1](#) [RD10A20-31-P8CS051/1](#) [RD16A14-12-S6CS051/2](#) [1301240290](#) [1301240347](#)