

THIS DOCUMENT IS SUBJECT TO CHANGE WITHOUT NOTICE. IT IS CONFIDENTIAL AND A PROPERTY OF Amphenol LTW. DISCLOSURE TO THIRD PARTY HAS TO BE AUTHORIZED BY Amphenol LTW.

REV.	ECN NO.	DATE	SIGN	DESCRIPTION
B	LEN14C0417	2014/12/10	Vicky	Update Logo & Dimension

**ALTW**  
**CONFIDENTIAL**  
 2014-12-10  
**R&D DEPT.**

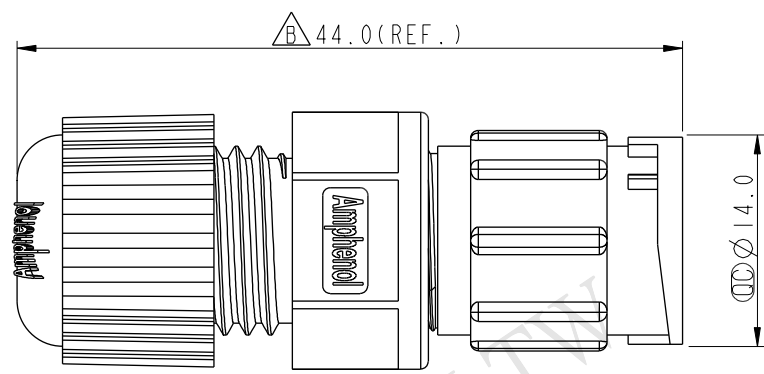
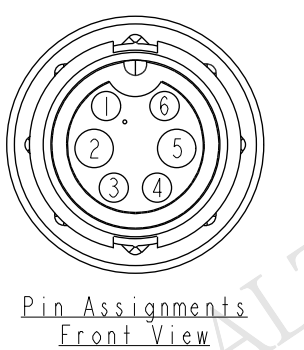
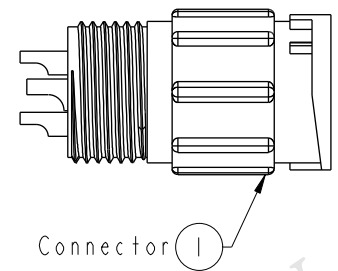
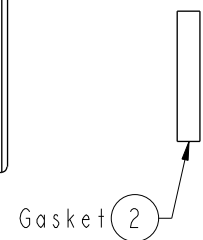
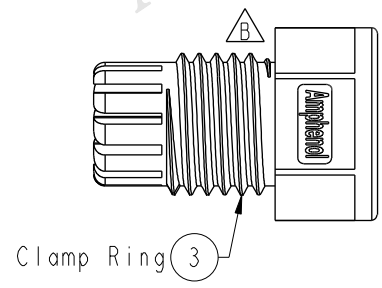
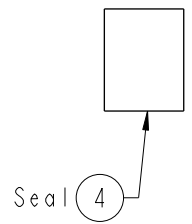
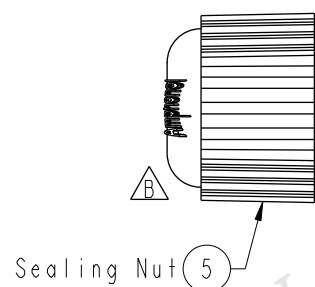

- Note:
- \*  $\varnothing$  Important Dimension To Check.
  - \* Waterproof Rate: IP67
  - \* Housing: Nylon+GF, Black
  - \* Female Pin: Copper Alloy, Gold Plated
  - \* Gasket: EPDM, Black
  - \* Clamp Ring: Nylon, Black
  - \* Seal: EPDM, Black
  - \* Sealing Nut: Nylon, Black
  - \* Seal For Cable OD:  $\varnothing 4.5\text{mm} \sim \varnothing 6.5\text{mm}$   
(防水墊圈線徑:  $\varnothing 4.5\text{mm} \sim \varnothing 6.5\text{mm}$ )
  - \* One Set Unassembled In One PE Bag  
(每一組未組裝, 放置於一個PE袋, 並封口)

UNIT:mm		
TOLERANCE	.X ±0.25	
.XX ±0.1		
.XXX ±0.05		
ANGLES	±1°	

TITLE Standard, Assy Lock 6Pin M Conn F Pin			
SCALE 3:2	SIZE A4	SHEET 1 OF 1	
REV. B	WC-REV. A.4	$\varnothing$ : Inspection item	

**Amphenol LTW**  
**安費諾亮泰企業股份有限公司**

ITEM NO BBD-06BMFA-LL7001	DRAWN BY Vicky	DATE 2014-12-10
DWG NO BBD-06BMFA-LL7001	CHECKED BY Sam	DATE 2014-12-10
CUSTOMER ALTW	APPROVED BY Rita	DATE 2014-12-10

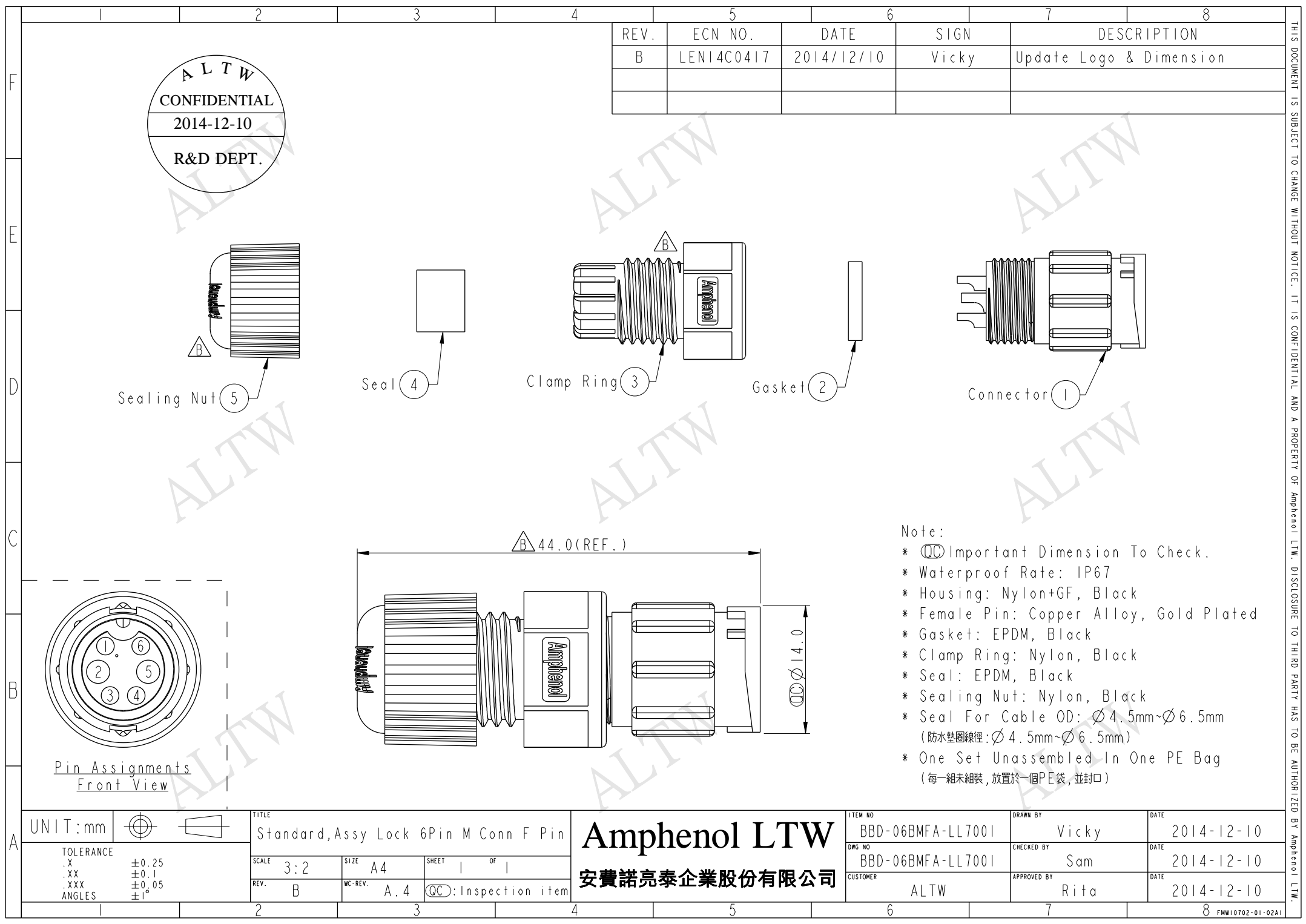

## X-ON Electronics

Largest Supplier of Electrical and Electronic Components

*Click to view similar products for [Standard Circular Connector](#) category:*

*Click to view products by [Amphenol](#) manufacturer:*

Other Similar products are found below :

[5M2530B10P](#) [600259N006](#) [600273N007](#) [6134-336-13149](#) [6134-337-11149](#) [6134-337-2390](#) [6134-341-17149](#) [6280-4SG-516](#) [6280-7SG-3DC](#)  
[6290](#) [6291A](#) [66200A-10](#) [680-SMG](#) [681-PMG](#) [CXS3102A14S2P](#) [CXS3102A181S](#) [7251-6SG-300](#) [7271-6SG-300](#) [7282-3PG-300-CH3](#) [75-](#)  
[474014-05S](#) [75-474618-01S](#) [75-474618-04S](#) [799539-000](#) [MI8-SE](#) [805-005-07NF11-19PC](#) [805-005-07NF15-7PA](#) [8280-4PG-516](#) [8280-7PG-](#)  
[519](#) [8282-5PG-519](#) [836783-1](#) [MP-4102-25P-C](#) [862256-1](#) [864019-2](#) [866857-1](#) [867865-1](#) [PT01SP-14-18P](#) [PT08P-14-5S](#) [PTSF06SE-14-12S](#)  
[120-1833-000](#) [QCM019PC2DC012B](#) [1-2069279-1](#) [121583-0217](#) [121667-0020](#) [129591AU](#) [1000B BULK](#) [RD10A16-19-P6CS051/1](#)  
[RD10A20-31-P8CS051/1](#) [RD16A14-12-S6CS051/2](#) [1301240290](#) [1301240347](#) [1301860202](#)