

Amphenol



LJT / HE 308

MIL-DTL-38999 Series I
Subminiature cylindrical connectors

www.amphenol-socapex.com - www.38999-solutions.com

■■■ Description

Amphenol Socapex is a MIL-DTL-38999 series I standard QPL and HE308 qualified manufacturer. The LJT product range was developed to meet the needs of the aerospace and military industries. It offers bayonet coupling connectors with a large variety of contact arrangements and shell types, maximum weight / space saving and a 100 % contact protection.

■■■ General Characteristics

- **Shell material**
 - Aluminium alloy
 - Marine bronze available - RoHS compliant
 - Carbon steel (for hermetic receptacles)
- **Finish**
 - Olive drab cadmium plating
 - Electroless nickel plating - RoHS compliant
 - Tin plating (for hermetic receptacles)
 - Cadmium free versions available
 - Others, please consult us (bright cadmium, black anodic coating)
- **9 shell sizes from 09 to 25**
- **Contacts**
 - More than 60 arrangements of contacts including high density and power versions
 - Size 00, 4, 8, 12, 16, 20, 22D, 23 contacts
 - Signal: crimp, PCB, wire-wrap, cable soldering (hermetic only)
 - Power: crimp, cable soldering, PCB
 - Coax: crimp, PCB
 - Twinax: crimp, PCB
 - Optical termini
 - Quadrax and differential twinax
- **Contact protection**
 - 100 % scoop-proof shell
 - Improved interfacial seal ensures sealing around each contact and prevents electrolytic erosion
- **EMI / RFI protection**
 - Grounding fingers on the plug shell
 - Grounded versions available

■■■ Applications

- **Military avionic applications**
- **Military vehicles, battlefield communication**

■■■ Additional Information

- Contacts (refer to datasheet DOC-000030-ANG)
- Power connectors, refer to datasheets LJT 25-1A (E116), LJT 21-48 (E117), LJT 23-P1 (E122), LJT 25-P1,
- Backshells (refer to datasheet E118)
- EWOC: Environmental Weatherproof Optical Connectors (refer to DOC-000503-ANG)
- High Density 38999

Table of Contents

DESCRIPTION, GENERAL CHARACTERISTICS & APPLICATIONS	2
TECHNICAL CHARACTERISTICS	
<i>Description</i>	4
<i>Mechanical characteristics</i>	4
<i>Environmental characteristics</i>	5
<i>Electrical characteristics</i>	6
<i>Insert arrangements</i>	7, 8, 9, 10 & 11
<i>Coding</i>	11
DIMENSIONS	
<i>Overall dimensions</i>	12
<i>Panel cut out</i>	14
STAND OFF RECEPTACLES	15
PRINTED CIRCUIT BOARD DRILLING	16, 17 & 18
STANDARD PCB TAIL DIMENSIONS AT THE REAR OF RECEPTACLES	18
HERMETIC RECEPTACLES	
<i>Main characteristics</i>	19
<i>Overall dimensions</i>	19
THRU-BULKHEAD RECEPTACLES	21
RECEPTACLES WITH ENHANCED SEALING	21
INTEGRATED BACKSHELLS	21
UNCODED CONNECTORS	21
LJTOP	22
ACCESSORIES	
<i>Protection caps</i>	23
<i>Dummy receptacles</i>	24
<i>Crimp contacts</i>	25
<i>Piggy back grommets</i>	25
<i>Sealing plugs</i>	26
<i>Dummy contacts</i>	26
<i>Standard PC tail contacts</i>	26
<i>Reducing ferrules</i>	27
<i>Plastic dust caps</i>	27
<i>Panel gaskets</i>	27
APPLICATION TOOLS	
<i>Crimping tools</i>	28
<i>Insertion and removal tools</i>	28
BACKSHELLS	29
HOW TO ORDER	
<i>Amphenol designation (LJT)</i>	30
<i>Hermetic receptacles</i>	30 & 31
<i>HE 308 / UTE 93-422 designation</i>	31
<i>MIL-DTL-38999 Series I designation</i>	32
CROSS REFERENCES	
<i>Connectors</i>	32
<i>Protection caps</i>	32

■ ■ ■ Technical Characteristics

Description

- 1 - Socket insert
- 2 - Grommet
- 3 - Crimping socket contact
- 4 - Grounding fingers (EMI)
- 5 - Interfacial seal
- 6 - Crimping pin contact
- 7 - Pin insert
- 8 - Sealing
- 9 - Contact retention clips
- 10 - Receptacle seal

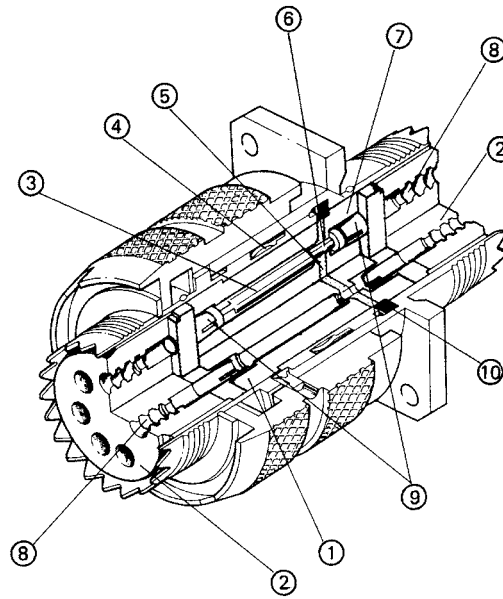

Mechanical characteristics

- Thermoplastic insert
- Fluorosilicone grommet and interfacial seal
- Durability: 500 cycles
- Contact retention force:

Contact Size	22 D	20	16	12	8	4	00
Maximum load (N)	45	67	110	110	150	150	150

■ ■ ■ Technical Characteristics

Environmental characteristics

SALT SPRAY EXPOSURE AND WORKING TEMPERATURE:

Waterproof shells

Shell material	Shell finish	Salt spray exposure per MIL.STD 1344/1099	Working temperature	
			min	max
Aluminium	Electroless Nickel O.D cadmium	48 H 500 H	- 65° C - 65° C	+ 200° C + 175° C
Bronze*	-	1000 H	- 65° C	+ 200° C

* Consult us

Hermetic shells

Shell material	Shell finish	Salt spray exposure per MIL.STD 1344/1099	Working temperature	
			min	max
Carbon steel	Tin	48 H	- 65° C	+ 150° C
Carbon Steel	O.D. Cadmium	500 H	- 65° C	+ 175° C

HUMIDITY: per MIL-DTL-38999 par. 3.29

AIR LEAKAGE: 1.10^{-7} cm³ /s under 1 bar of differential pressure (hermetics only)

FLUID IMMERSION per EIA364.10:

- Hydraulic fluid, per MIL-H-5606
- Turbine fluid, grade JP-8, per MIL-DTL-83133 (NATO TYPE 34)
- Lubricating oil, per MIL-L-7808
- Lubricating oil, per MIL-PRF-23699
- Defrosting fluid, per MIL-A-8243
- Cleaning compound, diluted for cleaning, per MIL-PRF-87937 type I alkaline base
- Gasoline, per ASTM-D-4814
- Gasohol, per A-A-52530
- One part isopropyl alcohol, per TT-I-735, grade A or B ; and 3 parts mineral spirits, per A-A-2904, type II, grade A or P-D-680, type I, by volume
- Coolant, dielectric fluid, synthetic silicate ester base MIL-PRF-47220 (Coolanol 25) or equivalent
- Hydraulic fluid M2-V Chevron oil ST0145LB0001 or equivalent

Technical Characteristics

Electrical characteristics

CONTACT RATING: NOMINAL CURRENT PER CONTACT

Contact size	22 D	20	16	12	8	4	00
Crimp (A)	5	7.5	13	23	60	100	230
Hermetic (A)	3	5	10	17	-	-	-
PC Tail (A)	3	4.5	10	17	40	-	-

CONTACT RESISTANCE

Contact size	22 D	20	16	12	8	4	00
Contact resistance (mΩ)	8	5	3	2	2	2	2

INSULATION RESISTANCE

Insulation resistance (500 V)	Crimp	Hermetic
Ambiant temperature	≥ 5.10 ³ MΩ	≥ 5.10 ³ MΩ
Maximal temperature	≥ 5.10 ² MΩ	≥ 5.10 ² MΩ

SERVICE RATING**

Service	Dielectric withstanding voltage (Vrms)								Working voltage	
	At sea level		15000 meters		21000 meters		34000 meters		Vrms	Vdc
	mated	unmated	mated	unmated	mated	unmated	mated	unmated		
M	1300	1300	800	550	800	350	800	200	400	550
N	1000	1000	-	400	-	260	-	200	300	450
I	1800	1800	1000	600	1000	400	1000	200	600	850
II	2300	2300	1000	800	1000	500	1000	200	900	1250

** Please note that the establishment of electrical safety factor is left entirely in the designer's hands, since he is the best position to know what peak voltage, switching surges, transients, etc... can be expected in a particular circuit.

DIMENSIONS OF ACCEPTABLE CONTACTS AND CABLES

Contact Size	Contact Diameter mm	Acceptable cables						
		Gauge AWG Section mm ²				Outside diameter (mm)		
		Min	Average	Max	Min	Average	Max	
22D	0.76	22	24	26	28	0.76	1.20	1.37
		0.38	0.22	0.15	0.095			
20	1	20	22	24	-	1.02	1.83	2.11
		0.60	0.38	0.22	-			
16	1.57	16	18	20	-	1.68	2.41	2.77
		1.34	0.93	0.60	-			
12	2.36	12	14	-	-	2.46	3.20	3.61
		3.30	1.94	-	-			
8 power	3.60	8				4.5	-	5.8
		8.98 Max acceptable: 10mm ²						
4	5.70	4				7.7	-	8.4
		21.10						
00	10.3	00				13.3	-	14.7
		100						

Technical Characteristics

Insert arrangements

Front face view of male insert

The major keyway is shown in the «normal» position

Contact size	22D	20	16	12	8	4	00
Caption	●	⊖	⊕	◐	●	○	⊗

1 Insert arrangement reference
2 Service class

3 Number of contacts
4 Contact sizes

09



1		09-22		09-35		09-98
2		I		M		I
3		2		6		3
4		20		22D		20

11

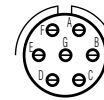
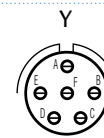
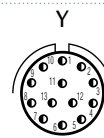
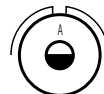
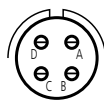

1	11-02	11-04	11-05	11-12 (11-01) **	11-35	11-98	11-99
2	I	I	I	II	M	I	I
3	2	4	5	1	13	6	7
4	16	20	20	12	22D	20	20

13

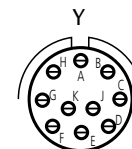
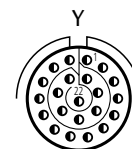
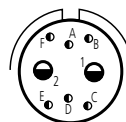
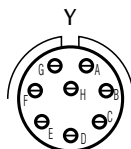
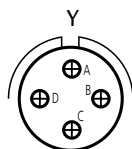

1	13-04	13-08	13-26		13-35	13-98
2	I	I	M		M	I
3	4	8	6	2	22	10
4	16	20	22D	12	22D	20

15

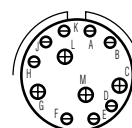
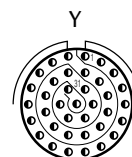
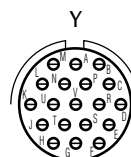
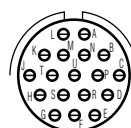
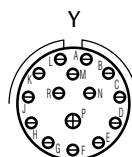
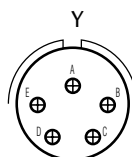
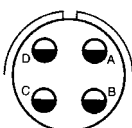

1	15-04	15-05	15-15		15-18	15-19	15-35	15-97	
2	I	II	I		I	I	M	I	
3	4	5	14	1	18	19	37	8	4
4	12	16	20	16	20	20	22D	20	16

* Military P/N delivered with 8 twinax and proprietary P/N delivered with size 8 coaxial contacts for RG 180 and RG 195 wire.

** HE 308 arrangement designation in brackets.

Y Available in hermetic version.

○ Delivered with twinax contacts for simple braid cable (M17/1760002, AECMA Pr EN 3375 - 003, Raychem 10612, EPD44690, EPD44691).

Technical Characteristics

Insert arrangements

Front face view of male insert

The major keyway is shown in the «normal» position

Contact size	22D	20	16	12	8	4	00
Caption	●	⊖	⊕	◐	●	○	⊗

1 Insert arrangement reference
2 Service class

3 Number of contacts
4 Contact sizes

17

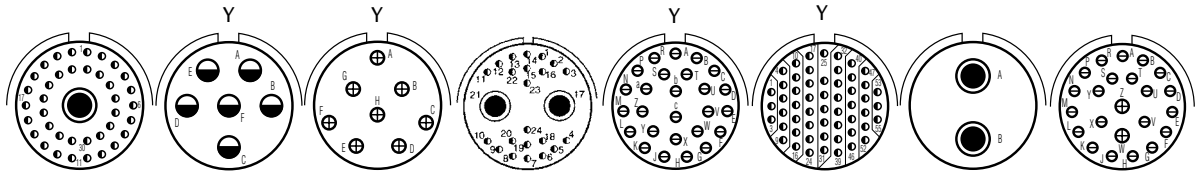

1	17-02	17-06	17-08	17-25	17-26	17-35	17-75	17-99
2	M	I	II	M	I	M	I	I
3	38	1	6	22	2	26	2	21
4	22D	8 Twinax ^o	12	22D	8 Coax	20	22D	20
							8 Twinax ^o	16

19

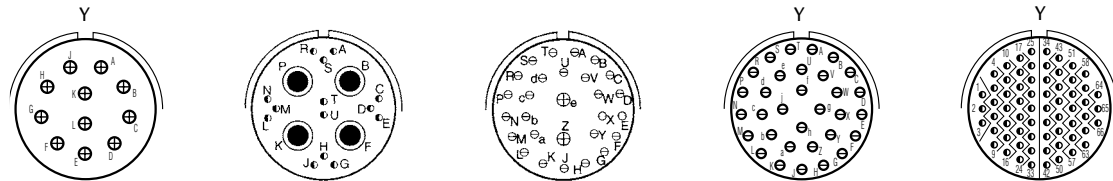

1	19-11	19-18	19-28	19-32	19-35
2	II		I	I	M
3	11	14	26	32	66
4	16	22D	20	20	22D
		8 Twinax ^o	16		

21

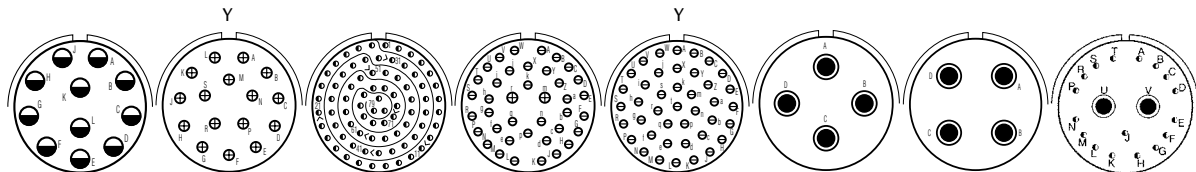

1	21-11	21-16	21-35	21-39	21-41	21-48	21-75	21-79
2	I	II	M	I	I	M	M	II
3	11	16	79	37	2	41	4	17
4	12	16	22D	20	16	20	8 Coax or 8 Twinax ^o	22D
						8 Power	8 Coax or 8 Twinax ^o	8 Coax [△]

* Military P/N delivered with 8 twinax and proprietary P/N delivered with size 8 coaxial contacts for RG 180 and RG 195 wire.

Y Available in hermetic version.

△ Coax contacts are not supplied unless specified by customer.

○ Delivered with twinax contacts for simple braid cable (M17/1760002, AECMA Pr EN 3375 - 003, Raychem 10612, EPD44690, EPD44691).

Technical Characteristics

Insert arrangements

Front face view of male insert

The major keyway is shown in the «normal» position

Contact size	22D	20	16	12	8	4	00
Caption	●	⊖	⊕	◐	●	○	⊗

1 Insert arrangement reference
2 Service class

3 Number of contacts
4 Contact sizes

23

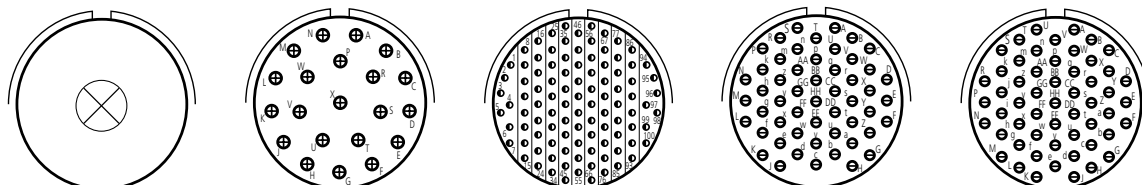

1	23-P1 (23-01)**	23-21	23-35	23-53	23-55
2	-	II	M	I	I
3	1	21	100	53	55
4	00 Power	16	22D	20	20

25

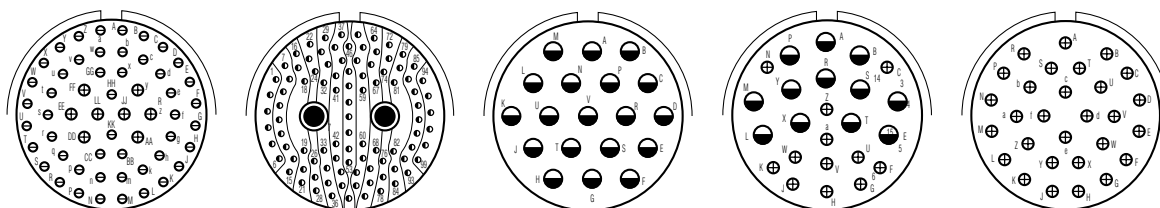

1	25-04	25-07	25-19	25-24	25-29			
2	I	M	I	I	I			
3	48	8	97	2	19	12	12	29
4	20	16	22D	8 Twinax°	12	16	12	16

25

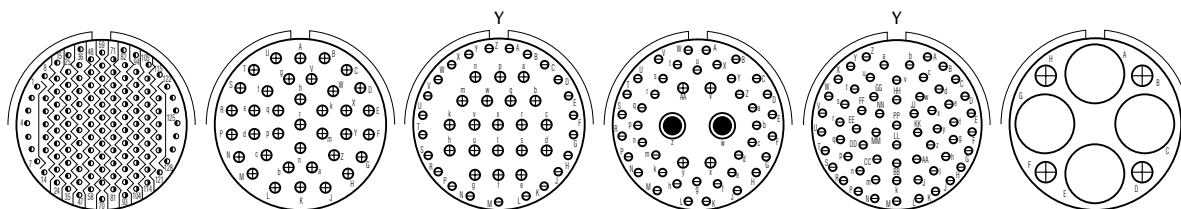

1	25-35	25-37	25-43	25-46	25-61	25-1A (24-44)**				
2	M	I	I	I	I	M				
3	128	37	23	20	40	4	4	61	4	4
4	22D	16	20	16	20	16	8 Coax	20	16	4

* Military P/N delivered with 8 twinax and proprietary P/N delivered with size 8 coaxial contacts for RG 180 and RG 195 wire.

** HE 308 arrangement designation in brackets.

Y Available in hermetic version.

○ Delivered with twinax contacts for simple braid cable (M17/1760002, AECMA Pr EN 3375 - 003, Raychem 10612, EPD44690, EPD44691).

Technical Characteristics

Insert arrangements

Arrangements of contacts	Hermetic (Y)	Service Rating	Total Contacts	Number and Size of Contacts									
				22D	20	16	12	12 Coax	8 power	8 coax	8 twinax	4	
09-35	Pin only	M	6	6									
09-98	Pin only	I	3		3								
09-22	-		2		2								
11-02	Pin only	I	2			2							
11-04	-	I	4		4								
11-05	-	I	5		5								
11-12 (11-01)	-		1				1						
11-35	Pin only	M	13	13									
11-98	Pin only	I	6		6								
11-99	-	I	7		7								
13-04	Pin only	I	4			4							
13-08	Pin only	I	8		8								
13-26	-	M	8	6			2						
13-35	Pin only	M	22	22									
13-98	Pin only	I	10		10								
15-04	-	I	4				4						
15-05	-	II	5			5							
15-15	Pin only	I	15		14	1							
15-18	Pin only	I	18		18								
15-19	-	I	19		19								
15-35	Pin only	M	37	37									
15-97	Pin only	I	12		8	4							
17-02	-	M	39	38									
17-06	Pin only	I	6				6						
17-08	Pin only	II	8			8							
17-25	-	M	24	22						2			
17-26	Pin only	I	26		26								
17-35	Pin only	M	55	55									
17-75	-	I	2									2	
17-99	-	I	23		21	2							
19-11	Pin only	II	11			11							
19-18	-	M	18	14								4	
19-28	-	I	28		26	2							
19-32	Pin only	I	32		32								
19-35	-	M	66	66									
21-11	-	I	11				11						
21-16	Pin only	II	16			16							

Bold letters: Preferred arrangement.

Technical Characteristics

Insert arrangements

Arrangements of contacts	Hermetic (Y)	Service Rating	Total Contacts	Number and Size of Contacts											
				22D	20	16	12	12 Coax	8 power	8 coax	8 twinax	4	00		
21-35	-	M	79	79											
21-39	-	I	39		37	2									
21-41	-	I	41		41										
21-48	-		4							4					
21-75	-	N	4							(see note 4)					
21-79	-	II	19	17					(see note 5)	2					
23-P1 (23-01)	-		1												1
23-21	Pin only	II	21			21									
23-35	-	M	100	100											
23-53	-	I	53		53										
23-55	-	I	55		55										
25-04	-	I	56		48	8									
25-07	-	M	99	97								2			
25-19	-	I	19				19								
25-24	-	I	24			12	12								
25-29	-		29			29									
25-35	-	M	128	128											
25-37	-	I	39			37									
25-43	Pin only	I	43		23	20									
25-46	-	I	46		40	4					2				
25-61	Pin only	I	61		61										
25-1 A (25-44)	-	M	8			4								4	

Bold letters: Preferred arrangement.

Note 4: MS connector 21-75 is supplied with four size 8 twinax contacts.
Proprietary connector 21-75 is supplied with 4 size 8 coax contacts.

Note 5: MS connector 21-79 has provision for 2 size 8 coax contacts.
Coax contacts are not supplied unless specified by customer.

Coding

To avoid cross-plugging problems in applications that require the use of more than one MIL-DTL-38999 I connector of the same size, alternate key-rotations are available as indicated in the chart below. As shown in the following diagram the master key rotates in the shell, and the insert always remains in the same position relative to the minor keys.

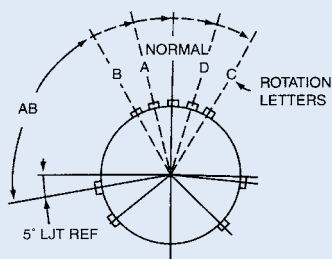

RELATIVE POSSIBLE POSITION OF ROTATED MASTER KEYWAY (front face of receptacle shown)

AB angles shown are viewed from the front face of the connector, a receptacle is shown beside. The angles for the plug are exactly the same except the direction of rotation is opposite of that shown for the receptacle.

Shell size	AB Angle of rotation (degrees)				
	Normal	A	B	C	D
9	95°	77°	-	-	113°
11	95°	81°	67°	123°	109°
13	95°	75°	63°	127°	115°
15	95°	74°	61°	129°	116°
17	95°	77°	65°	125°	113°
19	95°	77°	65°	125°	113°
21	95°	77°	65°	125°	113°
23	95°	80°	69°	121°	110°
25	95°	80°	69°	121°	110°

Dimensions

Overall dimensions

WALL MOUNTING RECEPTACLE *LJT 00 RT / HE 308 00 T / JMS27466 T*

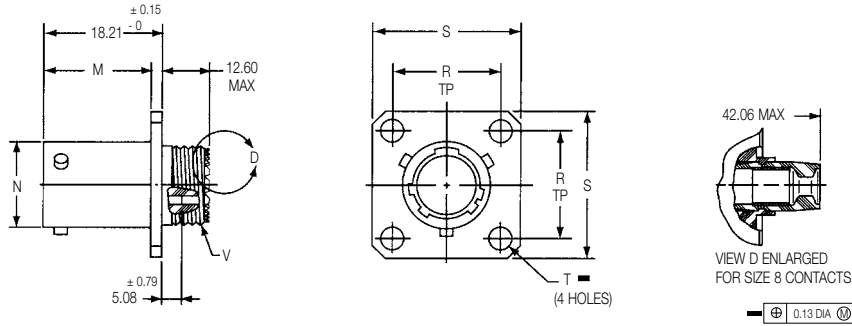

Shell Size	M + 0 - 0.13 (mm)	N + 0.03 - 0.13 (mm)	R (TP) (mm)	S ± 0.41 (mm)	T Dia ± 0.13 (mm)	V Thread Class 2A (plated)
9	16.05	14.53	18.26	23.83	3.25	.4375-28 UNEF
11	16.05	17.78	20.62	26.19	3.25	.5625-24 UNEF
13	16.05	21.59	23.01	28.58	3.25	.6875-24 UNEF
15	16.05	24.77	24.61	30.96	3.25	.8125-20 UNEF
17	16.05	27.94	26.97	33.32	3.25	.9375-20 UNEF
19	16.05	30.66	29.36	36.53	3.25	1.0625-18 UNEF
21	15.29	33.83	31.75	39.67	3.25	1.1875-18 UNEF
23	15.29	37.01	34.92	42.88	3.73	1.3125-18 UNEF
25	15.29	40.18	38.10	46.03	3.73	1.4375-18 UNEF

WALL MOUNTING RECEPTACLE (BACK PANEL MOUNTING) *LJT PQ00 RT / JMS27656 T*

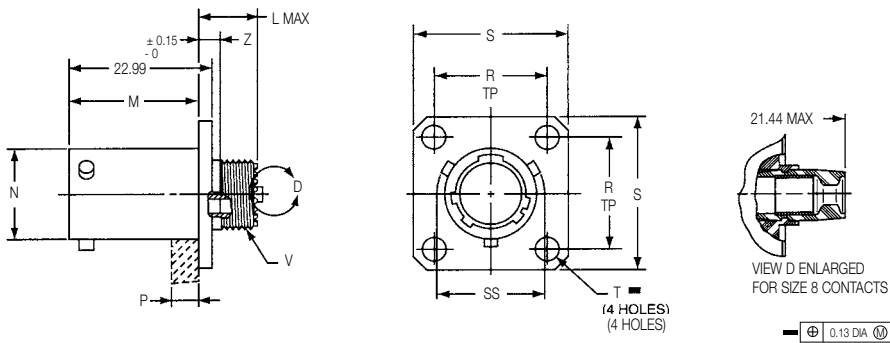

Shell Size	L Max. (mm)	M + 0 - 0.13 (mm)	N Dia (mm)	P Max. Panel Thickness (mm)	R (TP) (mm)	S + 0.28 - 0.25 (mm)	T Dia ± 0.13 (mm)	V Thread Class 2A (plated)	Z Max. (mm)
9	11.51	20.83	14.53	5.94	18.26	23.83	3.25	.4375-28 UNEF	3.50
11	11.51	20.83	17.78	5.94	20.62	26.19	3.25	.5625-24 UNEF	3.50
13	11.51	20.83	21.59	5.94	23.01	28.58	3.25	.6875-24 UNEF	3.50
15	11.51	20.83	24.77	5.94	24.61	30.96	3.25	.8125-20 UNEF	3.50
17	11.51	20.83	27.94	5.94	26.97	33.32	3.25	.9375-20 UNEF	3.50
19	11.51	20.83	30.66	5.94	29.36	36.53	3.25	1.0625-18 UNEF	3.50
21	12.29	20.07	33.83	5.18	31.75	39.67	3.25	1.1875-18 UNEF	4.27
23	12.29	20.07	37.01	5.18	48.02	42.88	3.73	1.3125-18 UNEF	4.27
25	12.29	20.07	40.18	4.90	38.10	46.03	3.73	1.4375-18 UNEF	4.27

Dimensions

STRAIGHT PLUG *LJT 06 RT / HE 308 06 T / JMS27467 T*

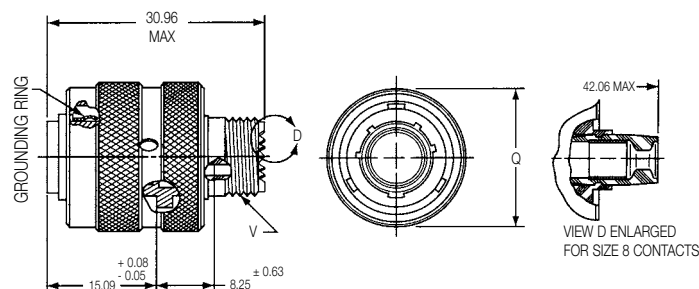

Shell Size	Q Max. (mm)	V Thread Class 2A (plated)
9	21.44	.4375-28 UNEF
11	24.61	.5625-24 UNEF
13	28.98	.6875-24 UNEF
15	32.16	.8125-20 UNEF
17	35.33	.9375-20 UNEF
19	38.10	1.0625-18 UNEF
21	41.28	1.1875-18 UNEF
23	44.45	1.3125-18 UNEF
25	47.63	1.4375-18 UNEF

JAM NUT RECEPTACLE *LJT 07 RT / HE308 07 T / JMS27468 T*

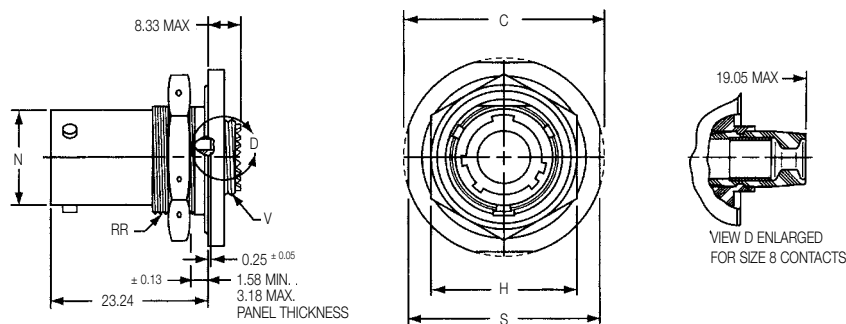

Shell Size	C Max. (mm)	H Hex + 0.43 - 0.41 (mm)	N + 0.03 - 0.13 (mm)	S ± 0.41 (mm)	V Thread Class 2A (plated)	RR Thread Class 2A (plated)	Hex. nut min/max torque value (N.m)
9	30.46	22.00	14.53	26.97	.4375-28 UNEF	.6875-24 UNEF	3.4 / 4.1
11	35.20	25.80	17.78	31.75	.5625-24 UNEF	.8125-20 UNEF	4.5 / 5.2
13	38.38	30.00	21.59	34.92	.6875-24 UNEF	1.0000-20 UNEF	6.2 / 6.8
15	41.55	33.00	24.77	38.10	.8125-20 UNEF	1.1250-18 UNEF	7.9 / 8.5
17	44.73	37.00	27.94	41.27	.9375-20 UNEF	1.2500-18 UNEF	9.0 / 9.6
19	49.51	40.00	30.66	46.02	1.0625-18 UNEF	1.3750-18 UNEF	10.2 / 10.7
21	52.65	43.00	33.83	49.23	1.1875-18 UNEF	1.5000-18 UNEF	11.3 / 12.4
23	55.86	46.00	37.01	52.37	1.3125-18 UNEF	1.6250-18 UNEF	12.4 / 13.6
25	59.13	51.20	40.18	55.58	1.4375-18 UNEF	1.7500-18 UNEF	13.6 / 14.7

Dimensions

LINE RECEPTACLE LJT 01 RT / HE 308 01 T

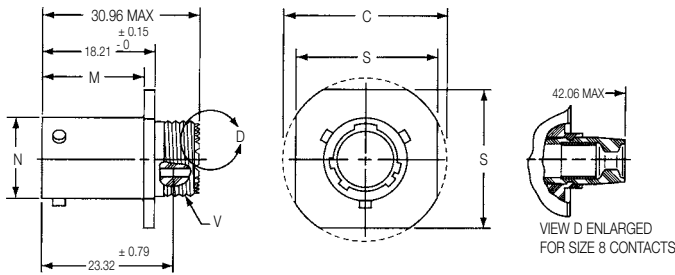

Shell Size	C Max. (mm)	M + 0 - 0.13 (mm)	N + 0.03 - 0.13 (mm)	S ± 0.41 (mm)	V Thread Class 2A (plated)
9	27.79	16.05	14.53	23.83	.4375-28 UNEF
11	30.18	16.05	17.78	26.19	.5625-24 UNEF
13	32.54	16.05	21.59	28.58	.6875-24 UNEF
15	34.93	16.05	24.77	30.96	.8125-20 UNEF
17	37.31	16.05	27.94	33.32	.9375-20 UNEF
19	40.49	16.05	30.66	36.53	1.0625-18 UNEF
21	43.66	15.29	33.83	39.67	1.1875-18 UNEF
23	46.84	15.29	37.01	42.88	1.3125-18 UNEF
25	50.01	15.29	40.18	46.03	1.4375-18 UNEF

Panel cut out

LJT PQ00
Square flange receptacle
back panel mounting

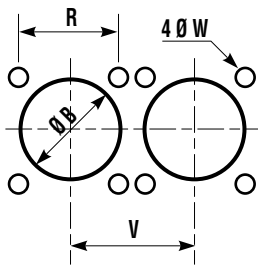

LJT 00
Square flange receptacle
front panel mounting

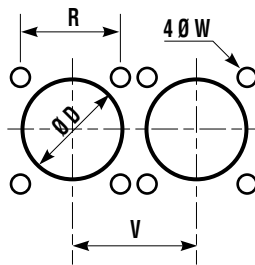

LJT 07
Jam nut receptacle
back panel mounting

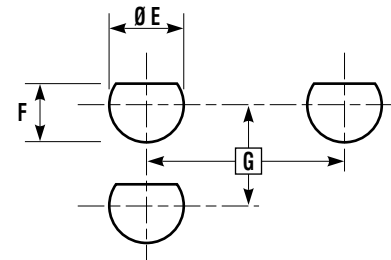

Shell Size	R (mm)	V + 0 - 0.25 (mm)	W + 0 - 0.25 (mm)	G Min (mm)	E Min (mm)	F + 0 - 0.25 (mm)	B + 0 - 0.41 Min (mm)	D + 0 - 0.25 Min (mm)
9	18.26	24.60	3.25	27.80	17.70	16.99	16.81	13.11
11	20.62	27.00	3.25	32.60	20.88	19.53	20.57	15.88
13	23.01	30.20	3.25	36.00	25.58	24.26	24.38	19.05
15	24.61	33.30	3.25	39.60	28.80	27.53	27.56	23.01
17	26.97	36.50	3.25	43.30	31.98	30.68	30.73	25.81
19	29.36	39.30	3.25	47.00	35.16	33.86	33.45	28.98
21	31.75	42.50	3.25	50.60	38.28	37.06	36.53	32.16
23	34.93	45.70	3.73	54.20	41.50	40.01	39.30	34.93
25	38.10	48.80	3.73	59.70	44.68	43.41	42.98	37.69

Stand Off Receptacles

Main characteristics

- Receptacles with stand-off flange shells, for attachment to printed circuit boards.
- The contacts are tin plated. Lead free versions are available.
- Available in wall mount (LJT PQ00) and jam nut (LJT 07) configurations.
- Prevent any mechanical stress on the contact tails.
- Provide grounding continuity between PCB and box.
- Increase reliability and resistance to shocks and vibrations.



Overall dimensions

JAM NUT RECEPTACLE (SIZE 9 and 11)

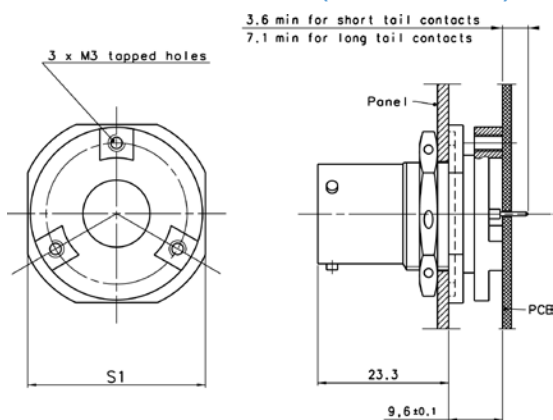

WALL MOUNT RECEPTACLE (SIZE 9 to 25)

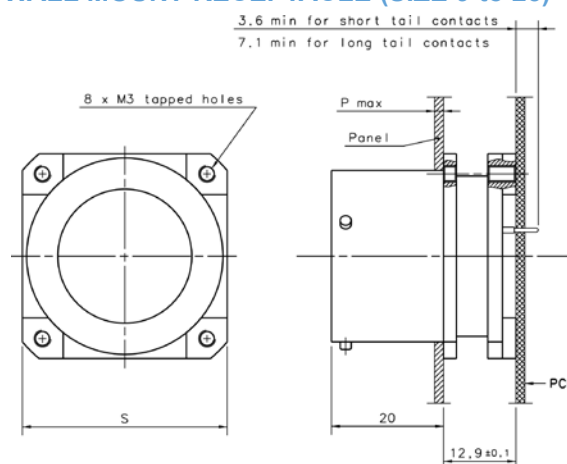

JAM NUT RECEPTACLE (SIZE 13 to 25)

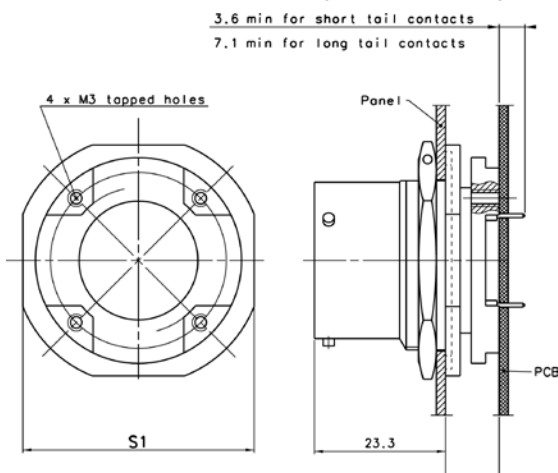

Shell Size	S ± 0.25 (mm)	Pmax (mm)	S1 ± 0.4 (mm)
9	23.82	5.18	27.00
11	26.19	5.18	31.80
13	28.57	5.18	34.90
15	30.96	5.18	38.10
17	33.32	5.18	41.30
19	36.52	5.18	46.00
21	39.67	5.18	49.20
23	42.87	5.18	52.40
25	46.02	4.90	55.60

Contact us for more detailed information.

For ordering informations, please refer to page 30.

Printed circuit Board drilling

Receptacles equipped with size 22D contacts

The marking of contact cavities is shown on the mating side view of male insert. The marking on the female insert is symmetrical in relation to the +Y/-Y axis. For recommended hole diameters ($\varnothing A$) see table on page 18.

Cavity marking	x (mm)	y (mm)
1	+1.14	+1.98
2	+1.98	-1.14
3	0	-2.29
4	-1.98	-1.14
5	+1.14	+1.98
6	0	0

9-35

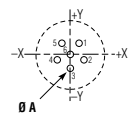

6 contacts size 22D

Cavity marking	x (mm)	y (mm)
1	0	+3.71
2	+2.16	+3.00
3	+3.51	+1.14
4	+3.51	-1.14
5	+2.16	-3.00
6	0	-3.71
7	-2.16	-3.00
8	-3.51	-1.14
9	-3.51	+1.14
10	-2.16	3.00
11	0	+1.42
12	+1.24	-0.89
13	-1.24	-0.89

11-35

13 contacts size 22D

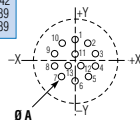

13-35

22 contacts size 22D

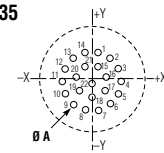

Cavity marking	x (mm)	y (mm)
1	+1.14	+5.00
2	+3.20	+4.01
3	+4.62	+2.24
4	+5.16	0

Cavity marking	x (mm)	y (mm)
5	+4.62	-2.24
6	+3.20	-4.01
7	+1.14	-5.00
8	-1.14	-5.00

Cavity marking	x (mm)	y (mm)
9	-3.20	-4.01
10	-4.62	-2.24
11	-5.16	0
12	-4.62	+2.24
13	-3.20	+4.01
14	-1.14	+5.00
15	+1.14	+5.00
16	+2.97	+0.66
17	+2.36	-1.91
18	0	-3.05
19	-2.36	-1.91
20	-2.97	+0.66
21	-1.14	+2.72
22	0	-0.76

15-35

37 contacts size 22D

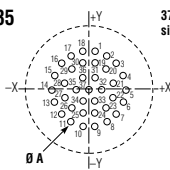

Cavity marking	x (mm)	y (mm)
17	-3.12	+5.51
18	-1.14	+6.65
19	+1.14	+4.37
20	+3.12	+3.02
21	+4.32	+1.02
22	+4.32	-1.27
23	+3.12	-3.23
24	+1.14	-4.37
25	-1.14	-4.37
26	-3.12	-3.23
27	-4.32	-1.27
28	-4.32	+1.02
29	-3.12	+3.02
30	-1.14	+4.37
31	+1.14	+1.88
32	+2.29	-0.10
33	+1.14	-2.08
34	-1.14	-2.08
35	-2.29	-0.10
36	-1.14	+1.88
37	0	-0.10

Cavity marking	x (mm)	y (mm)
1	+1.14	+6.65
2	+3.12	+5.51
3	+5.36	+4.06
4	+6.45	+2.03
5	+6.78	-0.25
6	+6.27	-2.49
7	+5.08	-4.45
8	+3.30	-5.89
9	+1.14	-6.65
10	-1.14	-6.65
11	-3.30	-5.89
12	-5.08	-4.45
13	-6.27	-2.49
14	-6.78	-0.25
15	-6.45	+2.03
16	-5.36	+4.06

19-35

66 contacts size 22D

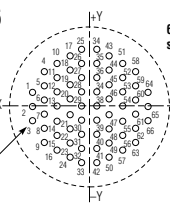

Cavity marking	x (mm)	y (mm)
35	+1.14	+6.86
36	+1.14	+4.57
37	+1.14	+2.29
38	+1.14	0
39	+1.14	-2.29
40	+1.14	-4.57
41	+1.14	-6.86
42	+1.14	-9.14
43	+3.12	+8.00
44	+3.12	+5.72
45	+3.12	+3.43
46	+3.12	+1.14
47	+3.12	-1.14
48	+3.12	-3.43
49	+3.12	-5.72
50	+3.12	-8.00
51	+5.11	+6.86
52	+5.11	+4.57
53	+5.11	+2.29
54	+5.11	0
55	+5.11	-2.29
56	+5.11	-4.57
57	+5.11	-6.86
58	+7.09	+5.72
59	+7.09	+3.43
60	+7.09	+1.14
61	+7.09	-1.14
62	+7.09	-3.43
63	+7.09	-5.72
64	+9.07	+2.29
65	+9.07	0
66	+9.07	-2.29

Cavity marking	x (mm)	y (mm)
1	-9.07	+2.29
2	-9.07	0
3	-9.07	-2.29
4	-7.09	+5.72
5	-7.09	+3.43
6	-7.09	+1.14
7	-7.09	-1.14
8	-7.09	-3.43
9	-7.09	-5.72
10	-5.11	+6.86
11	-5.11	+4.57
12	-5.11	+2.29
13	-5.11	0
14	-5.11	-2.29
15	-5.11	-4.57
16	-5.11	-6.86
17	-3.12	+8.00
18	-3.12	+5.72
19	-3.12	+3.43
20	-3.12	+1.14
21	-3.12	-1.14
22	-3.12	-3.43
23	-3.12	-5.72
24	-3.12	-8.00
25	-1.14	+9.14
26	-1.14	+6.86
27	-1.14	+4.57
28	-1.14	+2.29
29	-1.14	0
30	-1.14	-2.29
31	-1.14	-4.57
32	-1.14	-6.86
33	-1.14	-9.14
34	+1.14	+9.14

17-35

55 contacts size 22D

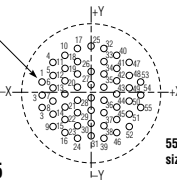

Cavity marking	x (mm)	y (mm)
1	-10.87	+6.12
2	-11.86	+3.91
3	-12.40	+1.55
4	-10.54	0
5	-12.40	-1.55
6	-10.87	-3.61
7	-10.87	-6.02
8	-8.43	+8.46
9	-8.43	+6.05
10	-8.43	+3.63
11	-8.43	+1.22
12	-8.43	-1.19
13	-8.43	-3.61
14	-8.43	-6.02
15	-8.43	-8.43
16	-6.32	+9.65
17	-6.32	+7.24
18	-6.32	+4.83
19	-6.32	+2.41
20	-6.32	0
21	-6.32	-2.41
22	-6.32	-4.83
23	-6.32	-7.24
24	-6.32	-9.65
25	-4.22	+10.87
26	-4.22	+8.46
27	-4.22	+6.05
28	-4.22	+3.63
29	-4.22	+1.22
30	-4.22	-1.19
31	-4.22	-3.61
32	-4.22	-6.02
33	-4.22	-8.43
34	-4.22	-10.85

Cavity marking	x (mm)	y (mm)
35	-2.11	+12.07
36	-2.11	+9.65
37	-2.11	+7.24
38	-2.11	+4.83
39	-2.11	+2.41
40	-2.11	0
41	-2.11	-2.41
42	-2.11	-4.83
43	-2.11	-7.24
44	-2.11	-9.65
45	-2.11	-12.07
46	0	+10.87
47	0	+8.46
48	0	+6.05
49	0	+3.63
50	0	+1.22
51	0	-1.19
52	0	-3.61
53	0	-6.02
54	0	-8.43
55	0	-10.85

Cavity marking	x (mm)	y (mm)
69	+4.22	+6.05
70	+4.22	+3.63
71	+4.22	+1.22
72	+4.22	-1.19
73	+4.22	-3.61
74	+4.22	-6.02
75	+4.22	-8.43
76	+4.22	-10.85
77	+6.32	+9.65
78	+6.32	+7.24
79	+6.32	+4.83
80	+6.32	+2.41
81	+6.32	0
82	+6.32	-2.41
83	+6.32	-4.83
84	+6.32	-7.24
85	+6.32	-9.65
86	+8.43	-8.46
87	+8.43	-6.05
88	+8.43	-3.63
89	+8.43	-1.22
90	+8.43	-1.19
91	+8.43	-3.61
92	+8.43	-6.02
93	+8.43	-8.43
94	+10.87	+6.12
95	+11.86	+3.91
96	+12.40	+1.55
97	+10.54	0
98	+12.40	-1.55
99	+10.87	-3.61
100	+10.87	-6.02

21-35

79 contacts size 22D

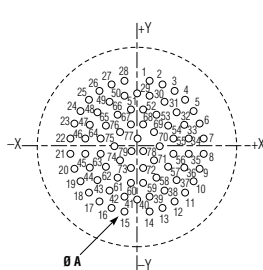

23-35

100 contacts size 22D

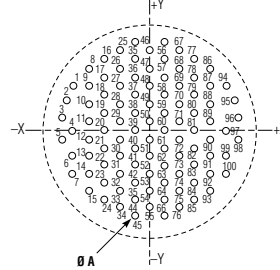

Printed circuit Board drilling

Cavity marking	x (mm)	y (mm)	Cavity marking	x (mm)	y (mm)	Cavity marking	x (mm)	y (mm)	Cavity marking	x (mm)	y (mm)	Cavity marking	x (mm)	y (mm)	Cavity marking	x (mm)	y (mm)
1	-12.17	+7.09	23	-8.43	-8.43	45	-4.22	-8.43	67	0	-6.02	89	+4.22	-3.61	111	+8.43	-3.61
2	-13.21	+4.83	24	-8.43	-10.85	46	-4.22	-10.85	68	0	-8.43	90	+4.22	-6.02	112	+8.43	-6.02
3	-13.87	+2.41	25	-6.32	+12.60	47	-4.22	-13.26	69	0	-10.85	91	+4.22	-8.43	113	+8.43	-8.43
4	-14.10	0	26	-6.32	+9.65	48	-2.11	+12.07	70	0	-14.10	92	+4.22	-10.85	114	+8.43	-10.85
5	-13.87	-2.41	27	-6.32	+7.24	49	-2.11	+9.65	71	+2.11	+12.70	93	+4.22	-13.26	115	+10.77	+9.07
6	-13.21	-4.83	28	-6.32	+4.83	50	-2.11	+7.24	72	+2.11	+9.65	94	+6.32	+12.60	116	+10.54	+4.83
7	-12.17	-7.09	29	-6.32	+2.41	51	-2.11	+4.83	73	+2.11	+7.24	95	+6.32	+9.65	117	+10.54	+2.41
8	-10.77	-9.07	30	-6.32	0	52	-2.11	+2.41	74	+2.11	+4.83	96	+6.32	+7.24	118	+10.54	0
9	-10.54	+4.83	31	-6.32	-2.41	53	-2.11	0	75	+2.11	+2.41	97	+6.32	+4.83	119	+10.54	-2.41
10	-10.54	+2.41	32	-6.32	-4.83	54	-2.11	-2.41	76	+2.11	0	98	+6.32	+2.41	120	+10.54	-4.83
11	-10.54	0	33	-6.32	-7.24	55	-2.11	-4.83	77	+2.11	-2.41	99	+6.32	0	121	+10.77	-9.07
12	-10.54	-2.41	34	-6.32	-9.65	56	-2.11	-7.24	78	+2.11	-4.83	100	+6.32	-2.41	122	+12.17	+7.09
13	-10.54	-4.83	35	-6.32	-12.07	57	-2.11	-9.65	79	+2.11	-7.24	101	+6.32	-4.83	123	+13.21	+4.83
14	-10.77	-9.07	36	-4.06	+13.49	58	-2.11	-12.07	80	+2.11	-9.65	102	+6.32	-7.24	124	+13.87	+2.41
15	-8.43	+11.28	37	-4.22	+10.85	59	0	+13.26	81	+2.11	-12.07	103	+6.32	-9.65	125	+14.10	0
16	-8.43	+8.43	38	-4.22	+8.43	60	0	+10.85	82	+4.06	+13.49	104	+6.32	-12.07	126	+13.87	-2.41
17	-8.43	+6.02	39	-4.22	+6.02	61	0	+8.43	83	+4.22	+10.85	105	+8.43	+11.28	127	+13.21	-4.83
18	-8.43	+3.61	40	-4.22	+3.61	62	0	+6.02	84	+4.22	+8.43	106	+8.43	+8.43	128	+12.17	-7.09
19	-8.43	+1.19	41	-4.22	+1.19	63	0	+3.61	85	+4.22	+6.02	107	+8.43	+6.02			
20	-8.43	-1.19	42	-4.22	-1.19	64	0	+1.19	86	+4.22	+3.61	108	+8.43	+3.61			
21	-8.43	-3.61	43	-4.22	-3.61	65	0	-1.19	87	+4.22	+1.19	109	+8.43	+1.19			
22	-8.43	-6.02	44	-4.22	-6.02	66	0	-3.61	88	+4.22	-1.19	110	+8.43	-1.19			

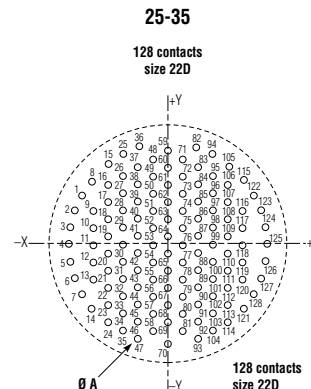

Receptacles equipped with size 20 contacts

The marking of contact cavities is shown on the mating side view of male insert. The marking on the female insert is symmetrical in relation to the +Y/-Y axis. For recommended hole diameters (Ø A) see table on page 18.

Cavity marking	x (mm)	y (mm)
A	+1.65	+0.97
B	0	-1.91
C	-1.65	+0.97

9-98

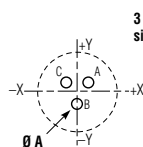

Cavity marking	x (mm)	y (mm)
A	0	+3.30
B	+1.65	-2.87
C	-1.65	-2.87
D	-3.30	0
E	0	0
F	0	0

11-98

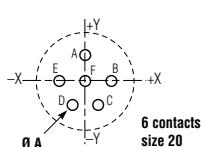

10 contacts size 20

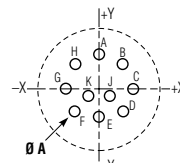

13-98

Cavity marking	x (mm)	y (mm)
A	0	+4.95
B	+3.18	+3.81
C	+4.90	+0.76
D	+4.17	-2.67
E	0	-3.43
F	-4.17	-2.67
G	-4.90	+0.76
H	-3.18	+3.81
J	+1.65	-0.38
K	-1.65	-0.38

15-19

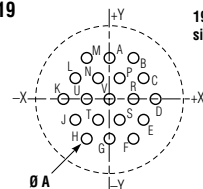

Cavity marking	x (mm)	y (mm)	Cavity marking	x (mm)	y (mm)
A	0	+5.72	C	+4.95	+2.87
B	+3.30	+5.72	D	+6.60	0

Cavity marking	x (mm)	y (mm)
E	+4.95	-2.87
F	+3.30	-5.72
G	0	-5.72
H	-3.30	-5.72
J	-4.95	-2.87
K	-6.60	0
L	-4.95	+2.87
M	-3.30	+5.72
N	-1.65	+2.87
P	+1.65	+2.87
R	+3.30	0
S	+1.65	-2.87
T	-1.65	-2.87
U	-3.30	0
V	0	0

Cavity marking	x (mm)	y (mm)
A	0	+8.15
B	+3.33	+7.44
C	+6.07	+5.44
D	+7.75	+2.51

Repère contact	x (mm)	y (mm)
E	+8.10	-0.86
F	+7.06	-4.09
G	+4.80	-6.60
H	+1.70	-7.98

Cavity marking	x (mm)	y (mm)
J	-1.70	-7.98
K	-4.80	-6.60
L	-7.06	-4.09
M	-8.10	-0.86
N	-7.75	+2.51
P	-6.07	+5.44
R	-3.33	+7.44
S	-1.78	+4.50
T	+1.78	+4.50
U	+4.45	+2.39
V	+4.52	-0.91
W	+3.02	-3.84
X	0	-5.16
Y	-3.02	-3.84
Z	-4.52	-0.91
a	-4.45	+2.39
b	0	+1.65
c	0	-1.65

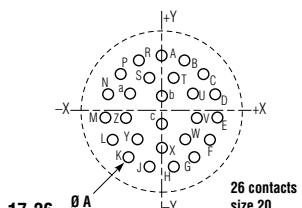

17-26

19-32

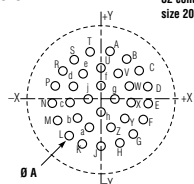

Cavity marking	x (mm)	y (mm)	Cavity marking	x (mm)	y (mm)
A	+1.68	+8.97	F	+8.15	-4.06
B	+4.80	+7.75	G	+6.15	-6.73
C	+7.26	+5.51	H	+3.30	-8.51
D	+8.76	+2.49	J	0	-9.12
E	+9.07	-0.84	K	-3.30	-8.51

Cavity marking	x (mm)	y (mm)
L	-6.15	-6.73
M	-8.15	-4.06
N	-9.07	-0.84
P	-8.76	+2.49
R	-7.26	+5.51
S	-9.07	+8.97
T	-1.68	+8.97
U	0	+5.84
V	+3.31	+4.90
W	+5.31	+2.41
X	+5.79	-0.84
Y	+4.42	-3.84
Z	+1.65	-6.61
a	-1.65	-6.61
b	-4.42	-3.84
c	-5.79	-0.84
d	-5.31	+2.41
e	-3.31	+4.90
f	0	+2.44
g	+2.44	0
h	0	-2.44
i	-2.44	0

21-41

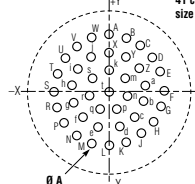

Cavity marking	x (mm)	y (mm)	Cavity marking	x (mm)	y (mm)
A	0	+10.60	J	+6.23	-8.58
B	+3.28	+10.09	K	+3.28	-10.09
C	+6.23	+8.58	L	0	-10.60
D	+8.58	+6.23	M	-3.28	-10.09
E	+10.09	+3.28	N	-6.23	-8.58
F	+10.60	0	P	-8.58	-6.23
G	+10.09	-3.28	R	-10.09	-3.28
H	+8.58	-6.23	S	-10.60	0

Cavity marking	x (mm)	y (mm)
T	-10.09	-3.28
U	-8.58	+6.23
V	-6.23	+8.58
W	-3.28	+10.09
X	0	+10.60
Y	+3.28	+10.09
Z	+6.23	+8.58
a	+8.58	+6.23
b	+10.09	+3.28
c	+10.60	0
d	+10.09	-3.28
e	+8.58	-6.23
f	+6.23	-8.58
g	+3.28	-10.09
h	+1.71	-6.99
i	-1.71	-6.99
j	-3.28	-10.09
k	-6.23	-8.58
l	-8.58	-6.23
m	-10.09	-3.28
n	-10.60	0
p	-10.09	+3.28
q	-8.58	+6.23
r	-6.23	+8.58
s	-3.28	+10.09
t	0	+10.60

Printed circuit Board drilling

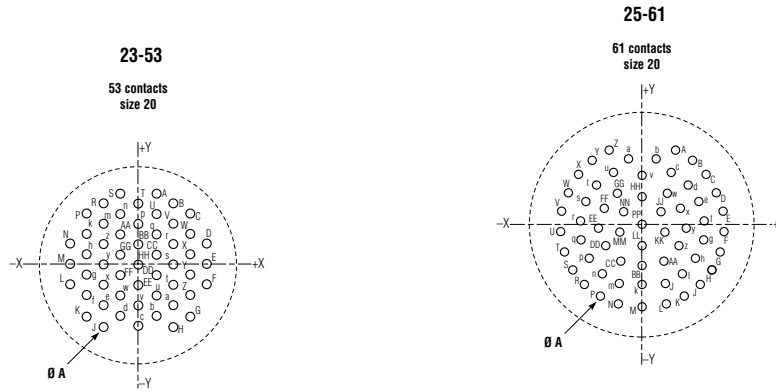

Cavity marking	X (mm)	Y (mm)	Cavity marking	X (mm)	Y (mm)	Cavity marking	X (mm)	Y (mm)
A	+2.84	+11.56	V	+5.72	+6.60	r	+5.72	+3.30
B	+5.72	+9.91	W	+8.53	+4.95	s	+5.72	0
C	+8.53	+8.26	X	+8.53	-1.65	t	+5.72	-3.30
D	+11.43	+3.30	Y	+8.53	-1.65	u	+2.84	-4.95
E	+11.43	0	Z	+8.53	-4.95	v	0	-6.60
F	+11.43	-3.30	a	+5.72	-6.60	w	-2.84	-4.95
G	+8.53	-8.26	b	+2.84	-8.26	x	-5.72	-3.30
H	+5.72	-10.41	c	0	-9.91	y	-5.72	0
J	-5.72	-10.41	d	-2.84	-8.26	z	-5.72	+3.30
K	-8.53	-8.26	e	+5.72	-6.60	AA	-2.84	+4.95
L	-11.43	-3.30	f	+8.53	-4.95	BB	0	+3.30
M	-11.43	0	g	+8.53	-1.65	CC	+2.84	+1.65
N	-11.43	+3.30	h	+8.53	+1.65	DD	+2.84	-1.65
P	-8.53	+8.26	k	+8.53	+4.95	EE	0	-3.30
R	-5.72	+9.91	m	-5.72	+6.60	FF	-2.84	-1.65
S	-2.84	+11.56	n	-2.84	+8.26	GG	-2.84	+1.65
T	0	+9.91	p	0	+6.60	HH	0	0
U	+2.84	+8.26	q	+2.84	+4.95			

Cavity marking	X (mm)	Y (mm)	Cavity marking	X (mm)	Y (mm)	Cavity marking	X (mm)	Y (mm)
A	+4.98	+12.70	Y	-7.98	+11.05	v	0	+8.59
B	+7.98	+11.05	Z	-4.98	+12.70	w	+3.73	+8.66
C	+10.49	+8.71	a	-1.73	+11.53	x	+6.02	+3.10
D	+12.32	-5.84	b	+1.73	+11.53	y	+6.78	-0.25
E	+13.39	-2.57	c	+4.39	+9.22	z	+5.79	-3.53
F	+13.61	-0.76	d	+7.24	+7.19	AA	+3.33	-5.92
G	+12.98	-4.17	e	+9.19	+4.45	BB	0	-6.78
H	+11.53	-7.29	f	+10.13	+1.17	CC	-3.33	-5.92
J	+9.35	-9.93	g	+9.96	-2.24	DD	-5.79	-3.53
K	+6.58	-11.94	h	+8.66	-5.41	EE	-6.78	-0.25
L	+3.40	-13.18	i	+6.38	-7.98	FF	-6.02	+3.10
M	0	-13.64	j	+3.38	-9.63	GG	-3.73	+5.66
N	-3.40	-13.18	k	0	-10.21	HH	0	+5.08
P	-6.58	-11.94	m	-5.38	-9.63	IJ	+2.67	+2.39
R	-9.35	-9.93	n	-6.38	-7.98	KK	+3.43	-1.04
S	-11.53	-7.29	p	-8.65	-5.41	LL	0	-3.35
T	-12.98	-4.17	q	-9.96	-2.24	MM	-3.43	-1.04
U	-13.61	-0.76	r	-10.13	+1.17	NN	-2.67	+2.39
V	-13.39	+2.57	s	-9.19	+4.45	PP	0	0
W	-12.32	+5.84	t	-7.24	+7.19			
X	-10.49	+8.71	u	-4.39	+9.22			

Please consult us for other insert arrangements.

Contacts	Ø A (mm) Minimum hole diameter			
	CI Version		LI Version	
	Gold PCB contacts	Tinned PCB contacts	Gold PCB contacts	Tinned PCB contacts
Size 22D	0.8	0.9	1.0	1.1
Size 20	1.0	1.1	1.0	1.1

Standard PCB Tail dimensions at the rear of receptacles

			LJT 07 CI	LJT 00 CI	LJT PQ00 CI	LJT PQ00 CI	LJT 07 LI	LJT 00 LI	LJT PQ00 LI	LJT PQ00 LI
			HE308 11T	size 09 to 25	size 09 to 19	size 21 to 25	size 09 to 25	size 09 to 25	size 09 to 19	size 21 to 25
			size 09 to 25	(mm)	(mm)	(mm)	(mm)	(mm)	(mm)	(mm)
Pin	L1	Min	8.73	13.76	11.28	12.04	8.73	13.76	11.28	12.04
		Max	9.70	14.60	12.11	12.87	9.70	14.60	12.11	12.87
	L2	Min	13.63	18.66	16.18	16.94	17.13	22.16	19.68	20.44
		Max	14.80	19.70	17.21	17.97	18.30	23.20	20.71	21.47
Socket	L1	Min	8.53	13.56	11.08	11.84	8.53	13.56	11.08	11.84
		Max	9.50	14.40	11.91	12.67	9.50	14.40	11.91	12.67
	L2	Min	13.43	18.46	15.98	16.74	16.93	21.96	19.48	20.24
		Max	14.60	19.50	17.01	17.77	18.10	23.00	20.51	21.27

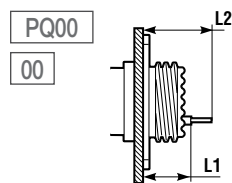
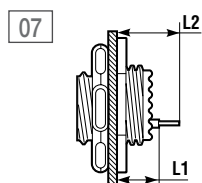

Hermetic Receptacles

Presentation

Hermetic receptacles LJT-Y are used in applications which require the maintenance of pressure in shell or box and in requirements imposing reduce bulk at the rear of connectors.

Main characteristics

- 9 shell sizes
- Solder or PCB pin contacts
- Contact plating in active zone: Gold
- Glass insert
- Interfacial seal
- Air leakage <math> < 1.10^{-7}</math> cm³ under 1 bar of differential pressure
- Tin or olive drab cadmium plating

Overall dimensions

WALL MOUNTING RECEPTACLE LJT 00Y / JMS27469 Y

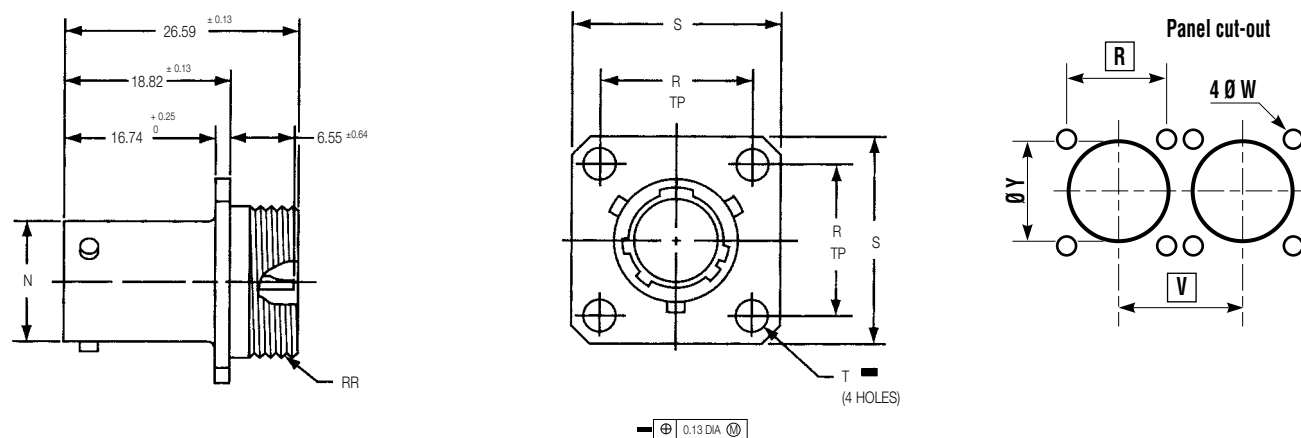

Shell Size	N Dia. +0.03 -0.13 (mm)	R (TP) (mm)	S +/-0.41 (mm)	T Dia. +/- 0.13 (mm)	RR Thread Class 2A	W +0 -0.25 (mm)	V Min (mm)	Y +0 -0.41 (mm)
9	14.53	18.26	23.82	3.25	.6875-24 UNEF	3.25	24.60	16.81
11	17.78	20.62	26.19	3.25	.8125-20 UNEF	3.25	27.00	20.57
13	21.59	23.01	28.57	3.25	.9375-20 UNEF	3.25	30.20	24.38
15	24.77	24.61	30.96	3.25	1.0625-18 UNEF	3.25	33.30	27.56
17	27.94	26.97	33.32	3.25	1.1875-18 UNEF	3.25	36.50	30.73
19	30.66	29.36	36.52	3.25	1.3125-18 UNEF	3.25	39.30	33.45
21	33.83	31.75	39.67	3.25	1.4375-18 UNEF	3.25	42.50	36.53
23	37.01	48.02	42.87	3.73	1.5625-18 UNEF	3.73	45.70	39.30
25	40.18	38.10	46.02	3.73	1.6875-18 UNEF	3.73	48.80	45.98

Hermetic Receptacles

JAM NUT RECEPTACLE LJT 07 Y / JMS27470 Y

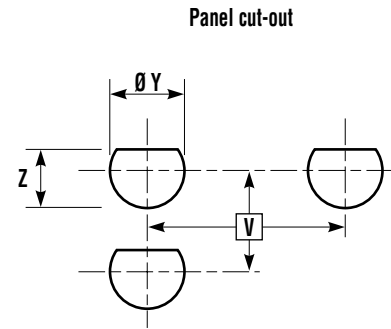
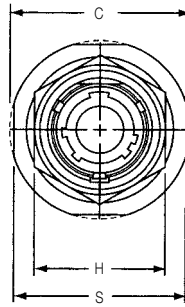
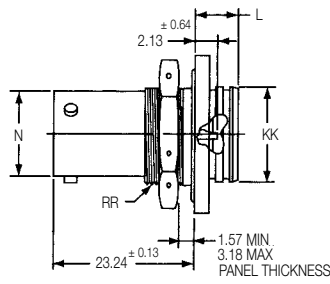

Shell Size	C Max. (mm)	H Hex + 0.43 - 0.41 (mm)	RR Thread Class 2A (Plated)	N + 0 - 0.13 (mm)	S +/- 0.41 (mm)	KK + 0.28 - 0 (mm)	L Max. (mm)	Dia. Y Min (mm)	Z + 0 - 0.25 (mm)	V Min (mm)
9	30.45	14.53	.6875-24 UNEF	14.53	26.97	16.31	7.54	17.70	16.99	27.80
11	35.20	17.78	.8125-20 UNEF	17.78	31.75	19.46	7.54	20.88	19.53	32.60
13	38.38	21.59	1.0000-20 UNEF	21.59	34.93	22.66	7.54	25.58	24.26	36.00
15	41.55	24.77	1.1250-18 UNEF	24.77	38.10	25.86	7.54	28.80	27.53	39.60
17	44.73	27.94	1.2500-18 UNEF	27.94	41.28	29.01	7.54	31.98	30.68	43.30
19	49.50	30.66	1.3750-18 UNEF	30.66	46.02	32.21	8.33	35.16	33.86	47.00
21	52.65	33.83	1.5000-18 UNEF	33.83	49.23	35.36	8.33	38.28	37.06	50.60
23	55.85	37.01	1.6250-18 UNEF	37.01	52.37	38.56	8.33	41.50	40.01	54.20
25	59.13	40.18	1.7500-18 UNS	40.18	55.58	41.71	8.33	44.68	43.41	59.70

SOLDER MOUNTING RECEPTACLE LJT 1 Y / JMS27471 Y

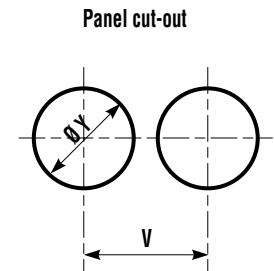
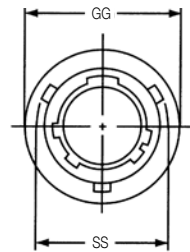
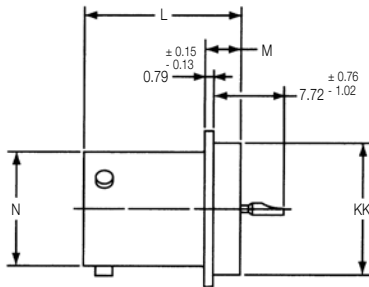

Shell Size	N Dia. + 0.03 - 0.13 (mm)	SS Dia. + 0 - 0.41 (mm)	L + 0.28 - 0 (mm)	M + 0.15 - 0.13 (mm)	GG Dia. + 0.03 - 0.13 (mm)	KK Dia. + 0.28 - 0.25 (mm)	Dia. Y + 0 - 0.41 (mm)	V Min (mm)
9	14.53	16.81	20.04	3.18	19.05	17.07	17.80	24.60
11	17.78	20.57	20.04	3.18	21.44	19.84	20.57	27.00
13	21.59	24.38	20.04	3.18	24.61	23.01	24.38	30.20
15	24.77	27.56	20.04	3.18	27.78	26.19	27.56	33.30
17	27.94	30.73	20.04	3.18	30.94	29.36	30.73	36.50
19	30.66	33.45	20.04	3.18	33.32	31.75	33.45	39.30
21	33.83	36.63	20.04	3.18	36.53	34.93	36.53	42.50
23	37.01	39.80	20.85	3.96	39.70	38.10	39.30	45.70
25	40.18	42.98	20.85	3.96	42.88	41.28	42.98	48.80

Thru-bulkhead Receptacles

HE308 0BT thru-bulkhead receptacles are used for the feed through of circuits on bulkheads or panels.



- Intermateable with MIL-DTL-38999 Series I connectors
- 9 shell sizes (aluminium alloy)
- Pin and socket double ended contacts
- Interfacial seal on male side
- Olive drab cadmium or nickel plating
- Coding possibility

For further information, please consult us.

Receptacles with Enhanced sealing

LJT 07 ETC receptacles with enhanced sealing are derived from the standard MIL-DTL-38999 Series I jam nut receptacles. The inserts have been modified to ensure an air leakage of $< 1.10^{-6} \text{cm}^3/\text{s}$ under 1 bar of differential pressure.



- Intermateable with MIL-DTL-38999 Series I connectors
- 9 shell sizes (aluminium alloy)
- Solder or PCB pin contacts. Socket contacts available upon request
- Olive drab cadmium or nickel plating

For further information, please consult us.

Integrated Backshells

Available on plugs and receptacles, these 2 in 1 connectors/backshells provide a high EMI protection with a quick, easy and cost effective cabling process. They are low profile, with enhance sealing level and allow the use of macro and micro bands, as well as straight or right angled heat shrink moulded pieces. The design of the shells make them compatible with over moulding process.

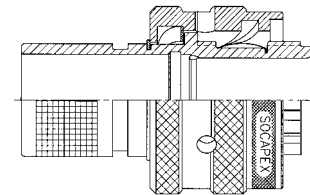

For further information, please consult us.

Uncoded Connectors

These connectors are mateable with any other ones regardless the coding is. (N, A, B, C or D)

HOW TO ORDER

Uncoded connectors	S	07	LJT	15 35	P	014
Shell type 00: Wall mounting receptacle 01: Line receptacle 06: Straight plug 07: Jam nut receptacle						
Series						
Shell size and insert arrangements: see pages 7, 8 and 9						
Contact type P: Pin S: Socket						
Shell finish 014: Olive drab cadmium plated 023: Electroless nickel plated						

LJTOP

The LJTOP connector is an optical version of the MIL-DTL-38999 series I connector, which uses standard 2.5 mm telecom optical termini.

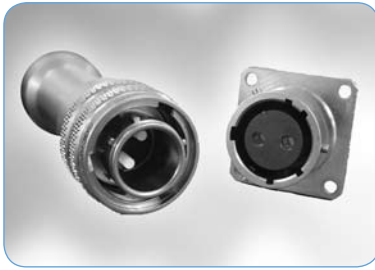

- 1 to 8 channels
- Available in multimode, singlemode PC and singlemode APC.
- 0.5 dB typical Insertion Loss in multimode and singlemode.

Insert arrangements

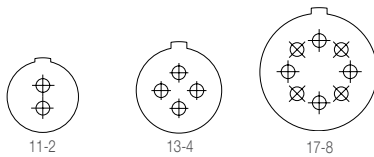

HOW TO ORDER LJTOP CONNECTORS

Series	LJTOP	07	W	R0	11	2	P7	N	X015
Shell type	00: Wall mounting receptacle 06: Plug 07: Jam nut receptacle								
Shell finish	F: Aluminium, electroless nickel plated W: Aluminium, olive drab cadmium plated								
Backshell	H0: Straight heatshrinkable backshell without clamp H9: Right angle heatshrinkable backshell without clamp R0: Straight backshell for pigtails (for receptacles only) S3: Straight backshell for multiway cable with metal integrated clamp S4: Straight backshell for multiway cable with plastic integrated clamp								
Shell size	Max Number of channels								
11	2								
13	4								
17	8								
Type of ceramic ferrule	P7: Multimode, 127 µm inner diameter P6: Singlemode, 126 µm inner diameter A6: Singlemode APC, 126 µm inner diameter (high return loss)								
Coding	N for normal or A, B, C, D. See coding system on page 11								
Cable diameter	X055: Ø5,5 mm multiway cable (for backshell H0, H9, S3, S4) X015: Ø1,5 mm for pigtail (for backshell R0)								

For more details, please consult the EWOC catalogue (DOC-000503-ANG)

Accessories

Protection caps

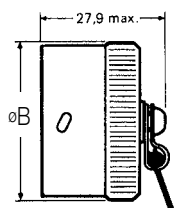

Protection caps for receptacles (metallic chain or nylon cord)

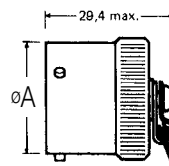

Protection caps for plugs (metallic chain or nylon cord)

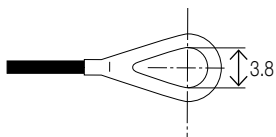

Termination of the nylon cord for square flange receptacle protection caps (for shell types: 00, PQ00)

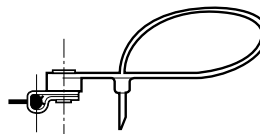

Terminations of the nylon cord for plugs protection caps (for shell type: 06)

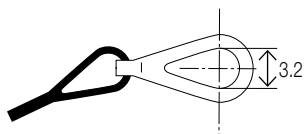

Termination of the chain for plug, square flange and line receptacle protection caps (for shell types: 06, 00, PQ00, 01)

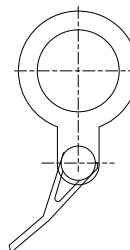

Termination of the chain or nylon cord for jam nut receptacle protection caps (for shell type: 07)



Chain version



Nylon cord version

- Cord length for plugs and line receptacles: 160 mm
- Cord length for square flange jam nut receptacles: 105 mm
- Chain length for plugs and receptacles: 111 mm

Shell size	9	11	13	15	17	19	21	23	25
A Dia Max (mm)	14.5	17.8	21.6	24.8	27.9	30.7	33.8	37.0	40.2
B Dia Max (mm)	21.4	24.6	28.6	31.8	35.7	38.1	41.3	44.5	47.6

HOW TO ORDER - AMPHENOL DESIGNATION

Caps series	B	EC	N	-	11	014
Protection cap type	F: For plug EC: For square flange receptacle ER: For jam nut receptacle P: For line mount receptacle					
Wire type	N: Nylon cord (standard version) Blank for metallic chain					
Cable ty option	A: without cable ty (only for plugs) Blank in other versions					
Corresponding connector size	09/11/13/15/17/19/21/23/25					
Finish	014: Olive-drab cadmium plated 023: Electroless nickel plated					

HE 308 DESIGNATION (WIRE TYPE: NYLON CORD)

HE	308	B	00	11	7	M
Protection cap	00: For square flange receptacle 01: For line mount receptacle 06: For plug 07: For jam nut receptacle					
Corresponding connector size	09/11/13/15/17/19/21/23/25					
Finish	7: Olive-drab cadmium plated 6: Electroless nickel plated					
M: Mandatory suffix						

Accessories

Dummy receptacles

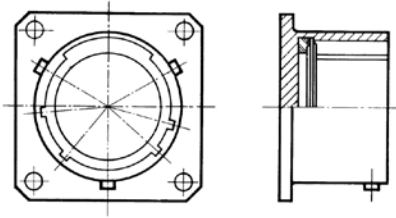

- Dummy receptacles are available in olive drab cadmium plated aluminium
- They match all plug types with any shell coding (N, A, B, C, D)
- Dimensions are identical to the front part of LJT00 receptacles
- A rubber washer ensures correct sealing of mated connectors
- Specific polarized versions are available on request

HOW TO ORDER - AMPHENOL DESIGNATION

Dummy receptacle	SE	00	LJT	09	014
Shell type 00: derived from the LJT wall mounting receptacle					
Series					
Shell size 09/11/13/15/17/19/21/23/25					
Finish 014: Olive-drab cadmium plated 023: Electroless nickel plated					

HOW TO ORDER - HE 308 DESIGNATION

Series	HE 308	R	00	09	7	M
Dummy receptacle						
Shell type 00: derived from the LJT wall mounting receptacle						
Shell size 09/11/13/15/17/19/21/23/25						
Finish 7: Olive-drab cadmium plated 6: Electroless nickel plated						
M: Mandatory suffix						

Holding support equipped with olive drab cadmium dummy receptacles

Reference: 809 891

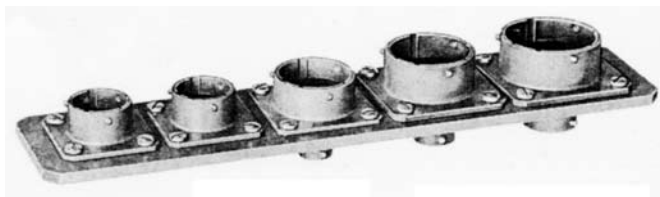

Accessories

Crimp contacts

	Contact size	Pin contacts		Socket contacts	
		Proprietary No	Military No	Proprietary No	Military No
Signal and Power	00	Refer to datasheet E122		Refer to datasheet E122	
	4	9000007	-	900047	-
	8	900197 900198*	-	900217	-
	12	900005	M39029/58-365	900045	M39029/56-353
	16	900000	M39029/58-364	900040	M39029/56-352
	20	900001	M39029/58-363	900041	M39029/56-351
	22D	900004	M39029/58-360	900044	M39029/56-348

* for arrangement 21-48 only

	Contact size	Pin contacts		Socket contacts		Cable Type
		Proprietary No	Military No	Proprietary No	Military No	
Coax	8	900130	M39029/60-367	900140	M39029/59-366	M17/95-RG180
		900135	-	90145	-	M17/94-RG179 M17/113-RG316 M17/119-RG174
	12	900340	M39029/28-211	900350	M39029/75-416	M17/94-RG179 M17/113-RG316 M17/119-RG174
		900341	M39029/28-409	900351	M39029/75-417	M17/95-RG180 Raychem 9528 A1318
		900342**	-	900352**	-	M17/113-RG316
	16	900132	M39029/76-424	900142	M39029/77-428	M17/94-RG179 M17/113-RG316 M17/119-RG174 KX22B
900131		M39029/76-425	900141	M39029/77-429	M17/93-RG178 M17/169-00001	
Twinax	8	074834 ²	M39029/90-529 ²	072453 ²	M39029/91-530 ²	M17/176-00002

** High performance size 12 coaxial contacts 50 ohms matched

² Supplied with heat shrink seal

For other cable types, please consult us

Piggy back grommets

The piggy back grommets insure back contact sealing when using size 8 power, coax or twinax contacts.

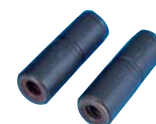

Type of contact	Cable OD (mm)	Proprietary No	HE308 designation
Size 8 power	4.4 to 5.2	900471	HE308 A03-08 M
Size 8 twinax and coax	3 to 4.4	900470	HE308 A02-08 M
Size 8 twinax and coax	4.4 to 5.2	900473	-

Accessories

Sealing plugs

to be mounted behind the crimp contacts

Contact size	Proprietary No	Military No	HE308 designation
8 coax	900024	-	-
8 power	900029	-	-
12	900023	MS27488-121	HE308 A01-12M
16	900020	MS27488-161	HE308 A01-16M
20	900021	MS27488-201	HE308 A01-20M
22D	900022	MS27488-221	HE308 A01-22M

Dummy contacts

to be mounted instead of the contacts

Contact size	Dummy contact material	Proprietary No
4	White plastic	900329
8	Green plastic	900488
8	Brass + gold finish	900183
8	White plastic	900029
12	Brass + gold finish	900025
12	White plastic	900486
16	Brass + gold finish	900028
16	Blue plastic	900026
20	Brass + gold finish	900332

Metal dummy contacts are recommended for applications requesting EMI protection.

Standard PC tail contacts

	Contact size	Type	Pin contacts		Socket contacts	
			Tail dimension (mm)	Proprietary No	Tail dimension (mm)	Proprietary No
Signal	12	CI	5	900238	5	-
	16	CI	5	900240	5	900263
		LI	8.5	900246	8.5	-
	20	CI	5	900241	5	900251
		LI	8.5	900243	8.5	-
	22D	CI	5	900245	5	900256
LI		8.5	922389	8.5	922390	
Coax	12	-	consult us	900489	-	-
		-	consult us	900409	-	-
	16	-	consult us	900184**	consult us	900405
Twinax	8	-	consult us	072265	-	-

** 900179 = 900184 + tin plating

Other PC tail lengths are available, please consult us.

Accessories

Reducing ferrules

Reducing ferrules allow using cables with smaller diameters than specified in the table page 6.

Reducing ferrule No	Contact size	Wire Gauge	Pin contacts	Socket contacts
No reducing ferrule	8	8	900197 / 900198	900217
900154		10		
No reducing ferrule	12	12	900005	900045
900092		14		
		16		
900093		18		
		20		
No reducing ferrule	16	16	900000	900040
		18		
		20		
900091	16	22	900000	900040
		24		
		26		
No reducing ferrule	20	20	900001	900041
		22		
900090	20	24	900001	900041
		26		
900094	20	28	900001	900041
		28		
900099	20	34	900001	900041
		30		
No reducing ferrule	22D	22	900004	900044
		24		
		26		
		28		

The sealing of mated connectors is only guaranteed for the minimum wire outside diameter given in the table page 6.

Plastic dust caps

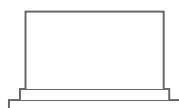

Shell size	Plastic dust caps for plug	Plastic dust caps for receptacles
9	805413	606061
11	805414	805413
13	606073	805414
15	606066	805415
17	606067	805416
19	606068	805417
21	606070	805418
23	606079	606068
25	606077	606078

Panel gaskets

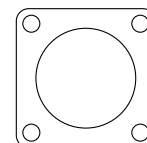

Square flange receptacle panel gaskets (thickness 0.8 mm)	HE308 reference
JE 09	HE308 J00-09M
JE 11	HE308 J00-11M
JE 13	HE308 J00-13M
JE 15	HE308 J00-15M
JE 17	HE308 J00-17M
JE 19	HE308 J00-19M
JE 21	HE308 J00-21M
JE 23	HE308 J00-23M
JE 25	HE308 J00-25M

Supplied with LJT 00 / HE308 00 / JMS27466 square flange receptacles

Application Tools

Crimping tools



Contact size	Contact type	Contact part number		Crimping tool		Positioner	
		Proprietary No	Military No	Proprietary No	Military No	Proprietary No	Military No
00		Refer to datasheet E122					
4	P	900007	-	809947	-	809948	-
	S	900047	-	809947	-	809948	-
8 Coax		Inner pin & socket		809 801	M22520/2-01	-	M22520/2-31
		Outer pin & socket		809 914	M22520/5-01	809 915	M22520/5-41
8 Power	P	900 197	-	809 872	-	809 873	-
	P	900 198	-	809 872	-	809 873	-
	S	900 217	-	809 872	-	809 873	-
12 Coax		Inner pin & socket		809 801	M22520/2-01	809 932	M22520/2-34
		Outer pin & socket		809 926	M22520/31-01	809 927	M22520/31-02
12	P	900 005	M39029/58-365	809 857	M22520/1-01	809 858	M22520/1-04
	S	900 045	M39029/56-353	809 857	M22520/1-01	809 858	M22520/1-04
16 Coax		Inner pin & socket		809 801	M22520/2-01	809 862	M22520/2-35
		Outer pin & socket		809 863	M22520/4-01	809 864	M22520/4-02
16	P	900 000	M39029/58-364	809 857	M22520/1-01	809 858	M22520/1-04
	S	900 040	M39029/56-352	809 857	M22520/1-01	809 858	M22520/1-04
20	P	900 001	M39029/58-363	809 857	M22520/1-01	809 858	M22520/1-04
				809 801	M22520/2-01	809 826	M22520/2-10
	S	900 041	M39029/56-351	809 857	M22520/1-01	809 858	M22520/1-04
22D				809 801	M22520/2-01	809 826	M22520/2-10
	P	900 004	M39029/58-360	809 801	M22520/2-01	809 810	M22520/2-09
	S	900 044	M39029/56-348	809 801	M22520/2-01	809 835	M22520/2-07

Insertion and removal tools

PLASTIC TOOLS



Contact size	Insertion tool		Removal tool		Colour	
	Proprietary No	Military No	Proprietary No	Military No	Insertion	Extraction
8 Power	*	*	-	M81969/14-12	-	green
12	809 859	M81969/14-04	809 859	M81969/14-04	yellow	white
16	809 855	M81969/14-03	809 855	M81969/14-03	blue	white
20	809 854	M81969/14-10	809 854	M81969/14-10	red	orange
22D	809 856	M81969/14-01	809 856	M81969/14-01	green	white

* Manual insertion

METALLIC TOOLS



Contact size	Straight type		Angle type			
	Insertion tools Proprietary No	Removal tools Proprietary No	Insertion tools		Removal tools	
			Proprietary No	Military No	Proprietary No	Military No
4	*	809943	-	-	-	-
8 Power/coax	-	809961	*	*	809 845	-
12	-	-	809 838	M81969/8-09	809 839	M81969/8-10
16	809 816	809 846	809 812	M81969/8-07	809 820	M81969/8-08
20	809 817	809 847	809 813	M81969/8-05	809 821	M81969/8-06
22D	809 819	809 849	809 815	M81969/8-01	809 823	M81969/8-02

* Manual insertion

Backshells

Shielding

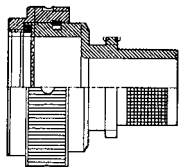

HE308-35: BAND BACKSHELL FOR SHIELDING

- Full 360° shield termination
- Available with different cabling chambers
- Easy maintenance or repairability
- Sealing ensured by straight or right angled heat-shrink molded piece
- Right angle version: LJT SBC

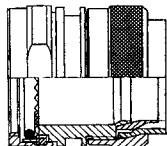

LJT NSA (HE308-13): HIGH LEVEL OF EMI/RFI PROTECTION

- Electrical continuity between cable and connector by clamping the braid with a screwing system
- Free inner ring to avoid twisting of the braid when screwing
- Sealing ensured by straight or right angle heat-shrink molded piece

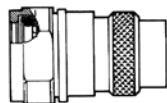

LJT NSB

- Shielding by braid soldering on the tinned rear part.
- Sealing ensured by straight or right angle heat-shrink molded piece

Sealing

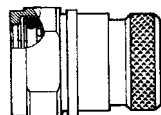

LJT NSD (HE308-14): ADAPTER FOR HEAT-SHRINK MOLDED PIECE

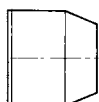

LJT RPD (HE308-15): BACKSHELL FOR POTTING

- 75° angle version: LJT RPC (HE308-16)



HE308-17: BACK NUT

Mechanical retention

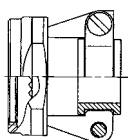

LJT SRD (HE308-11): STRAIN RELIEF

- Mechanical retention of the cable
- Easy maintenance or repairability

For more detailed information, consult our Backshell catalog (E118)

How to Order

Amphenol designation

Series	LJT	07	RT	15	35	P	-	014	-	-
Shell type										
00: Wall mounting receptacle										
PQ00: Wall mounting receptacle (back panel)										
01: Line receptacle										
06: Straight plug										
07: Jam nut receptacle										
Service class and contact style										
RT: Environmental, with accessory thread, crimp contacts										
CI: PCB contacts										
LI: Long PCB contacts										
DW: Wire wrap contacts										
ETC: Enhanced sealing (07 receptacles only), solder pin contacts										
ETCI: Enhanced sealing (07 receptacles only), PCB pin contacts										
Shell size										
09/11/13/15/17/19/21/23/25										
Insert arrangement										
See pages 7, 8, 9										
Contact type										
P: Pin										
S: Socket										
Coding										
Blank for normal or A, B, C, D. See coding system on page 11										
Shell finish										
014: Olive drab cadmium plated										
023: Electroless nickel plated										
Contacts										
Blank for connector delivered with contacts										
LC: Connector delivered without contact										
Deviation										
F404: Tinned PCB contacts (lead free versions available)										
F459: Stand-off receptacle (see page 15)										
For other deviations (FXXX), please consult us.										

Hermetic Receptacles

Series	LJT	07	Y	15	35	P	-	-
Shell type								
00: Wall mounting receptacle								
07: Jam nut receptacle								
I: Solder mount receptacle								
Service class and contact style								
Y: Hermetic with interfacial seal, solder contacts								
Shell size								
09/11/13/15/17/19/21/23/25								
Insert arrangement								
See pages 7, 8, 9								
Contact type								
P: Pin only								
Coding								
Blank for normal or A, B, C, D. See coding system on page 11								
Shell finish								
Blank for tin plated								
014: Olive drab cadmium plated								

How to Order

HE 308 / UTE 93422 designation

Series	HE308	07	T	15	35	P	N	7	M	-
Shell and contact style										
00: Wall mounting receptacle, crimp contacts 01: Line mount receptacle, crimp contacts 06: Straight plug, crimp contacts 07: Jam nut receptacle, crimp contacts 11: Jam nut receptacle, PCB contacts										
Service class										
T: Environmental, with accessory thread										
Shell size										
09/11/13/15/17/19/21/23/25										
Insert arrangement										
See pages 7, 8, 9										
Contact type										
P: Pin S: Socket										
Coding										
N for normal or A, B, C, D. See coding system on page 11										
Shell finish										
7: Olive drab cadmium plated 6: Electroless nickel plated										
M: Mandatory suffix										
Contacts										
Blank for connector delivered with contacts L: Connector delivered without contact										

Hermetic Receptacles

Series	HE308	07	Y	15	35	P	N	7	M
Shell type									
00: Wall mounting receptacle 07: Jam nut receptacle I: Solder mount receptacle									
Service class and contact style									
Y: Hermetic with interfacial seal, solder contacts									
Shell size									
09/11/13/15/17/19/21/23/25									
Insert arrangement									
See pages 7, 8, 9									
Contact type									
P: Pin only									
Coding									
N: for normal or A, B, C, D. See coding system on page 11									
Shell finish									
7: Olive drab cadmium plated 2: Tin plated									
M: Mandatory suffix									

How to Order

MIL-DTL-38999 Series I designation

Shell type JMS27466: Wall mounting receptacle JMS27656: Wall mounting receptacle (Back panel mounting) JMS27467: Straight plug JMS27468: Jam nut receptacle	JMS27467	T	15	B	35	S	N
Service class							
Shell size 09/11/13/15/17/19/21/23/25							
Shell Finish B: Olive drab cadmium plated F: Electroless nickel plated							
Insert arrangement See pages 7, 8, 9							
Contact type P: Pin A: Without pin contact S: Socket B: Without socket contact							
Coding Blank for normal or A, B, C, D. See coding system on page 11.							

CrossReferences

Connectors

Version	Amphenol	NFC93422 / HE 308	MIL-DTL-38999 I
Standard	LJT00RTXX-XX X * 014	HE 308 00 TXX-XX X * 7M	JMS 27466 T XX B XX X *
	LJTPQ00RTXX-XX X * 014		JMS 27656 T XX B XX X *
	LJT01RTXX-XX X * 014	HE 308 01 TXX-XX X * 7M	
	LJT06RTXX-XX X * 014	HE 308 06 TXX-XX X * 7M	JMS 27467 T XX B XX X *
	LJT07CIXX-XX X * 014	HE 308 11 TXX-XX X * 7M	
	LJT07RTXX-XX X * 014	HE 308 07 TXX-XX X * 7M	JMS 27468 T XX B XX X *
Hermetics	LJT00 Y XX-XX P *		JMS 27469 Y XX-XX P *
	LJT07 Y XX-XX P *		JMS 27470 Y XX-XX P *
	LJTI Y XX-XX P *		JMS 27471 Y XX-XX P *

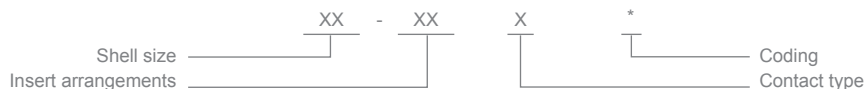

Protection caps

MS designations are also available. The cross references below are given as information only. Amphenol's and MS designs are not strictly equivalent: the length of the chain or rope, as well as the attachment style could vary.

Amphenol designation	MS designation
BF XX 014	JMS 27501 B XX C
BEC XX 014	JMS 27502 B XX C
BER XX 014	JMS 27502 B XX N
BP XX 014	JMS 27502 B XX C

XX: Shell size



The information given in this document are as a guideline only. We reserve the right to modify our products in any way we deem necessary. Any duplication is prohibited, unless approved in writing. Design by Steven Kilgallon - June 2008

DOC-000031-ANG/B

Your local Contact:

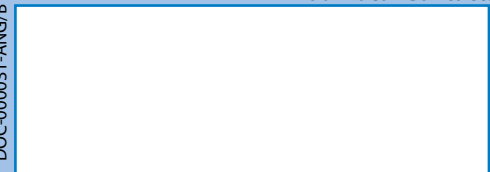

For more information, please visit our websites:
www.amphenol-socapex.com - www.38999-solutions.com

X-ON Electronics

Largest Supplier of Electrical and Electronic Components

Click to view similar products for [D-Sub Tools & Hardware](#) category:

Click to view products by [Amphenol](#) manufacturer:

Other Similar products are found below :

[173112-0667](#) [173112-0759](#) [173112-0967](#) [173112-0291](#) [173112-0456](#) [000-01-09-132](#) [000-01-21-132](#) [000-01-31-162](#) [572019-00105-70](#)
[000-01-37-162](#) [621-250-113-115](#) [D20418-2R](#) [D20418-J3F](#) [70521CLF](#) [70524BLF](#) [70527BLF](#) [70527CLF](#) [F1042-1PLAH](#) [750643-1](#) [780-010-](#)
[06G4-00C](#) [780-518-50SG6-WS](#) [863004ATLF](#) [86552009](#) [86553115TLF](#) [86553117TLF](#) [86553156LF](#) [FSGK1/5](#) [980-8554-000](#) [980-8555-000](#)
[980-8557-000](#) [980-8558-000](#) [1230032-1](#) [1-5021101-2](#) [15-000050](#) [1589283-4](#) [160-000-005R031](#) [16-000230](#) [160-020-109R000](#) [160-025-](#)
[004R031](#) [160-015-003R031](#) [160-020-209R000](#) [160X10909X](#) [164C03939A](#) [177-505-A-2-2](#) [177-505-C-4-4](#) [179-013-1H](#) [1-966830-8](#) [21018-6](#)
[21028-3](#) [213622-5](#)