

Smart Card Connectors

Series C700



Note from the CEO



Ladies and Gentlemen,

For over 75 years Amphenol has enjoyed success as the interconnection technology provider of choice to industry-leading companies around the world. One of our key strategic areas of focus has been and is the Industrial market. Our organization works with leading manufacturers across a wide range of applications - including Energy Generation & Distribution, Transportation, Heavy Equipment, Factory Automation, Wireless Outdoor, ChipCard Readers - enabling smarter, faster and better technologies to connect products to customer solutions.

The Industrial market footprint of Amphenol covers over facilities in more than 12 different European countries and more than 30 countries worldwide. Our successful expansion into new regions as well as new industrial applications is a direct reflection of our agile, entrepreneurial management team and our unwavering commitment to execute Amphenol's strategies for the benefit of our customers, shareholders and employees.

Thank you for partnering with Amphenol. Our entire organization is at your service.

A handwritten signature in black ink, appearing to read 'R. Adam Norwitt'. The signature is fluid and cursive, with a long horizontal stroke at the end.

R. Adam Norwitt
President and CEO, Amphenol Corporation

Contents

<p>Mating Cycles</p>	<p>500 000</p>	<p>C702 F p. 15</p> 		<p>C703 A p. 8</p> 
				<p>C702 A p. 9</p> 
				<p>C702 B p. 10</p> 
	<p>300 000</p>		<p>C702 D p. 12</p> 	<p>C702 C p. 13</p> 
				<p>C702 Y p. 15</p> 
	<p>100 000</p>	<p>C702 E p. 14</p> 		
	<p>C702 G p. 14</p> 			
			<p>PCB Assembly</p>	<p>Free Assembly</p>

Applications for Smart Card Connectors

Payment

- Smart Card Connector for payment terminals
- EMV (Europay Mastercard Visa) and PCI (Payment Card Industry) compliant
- Small form factor



Vending and Metering

- Smart Card Connectors for vending machines and gas-, water and electricity meters
- Vandalism resistant solutions
- Highly reliable

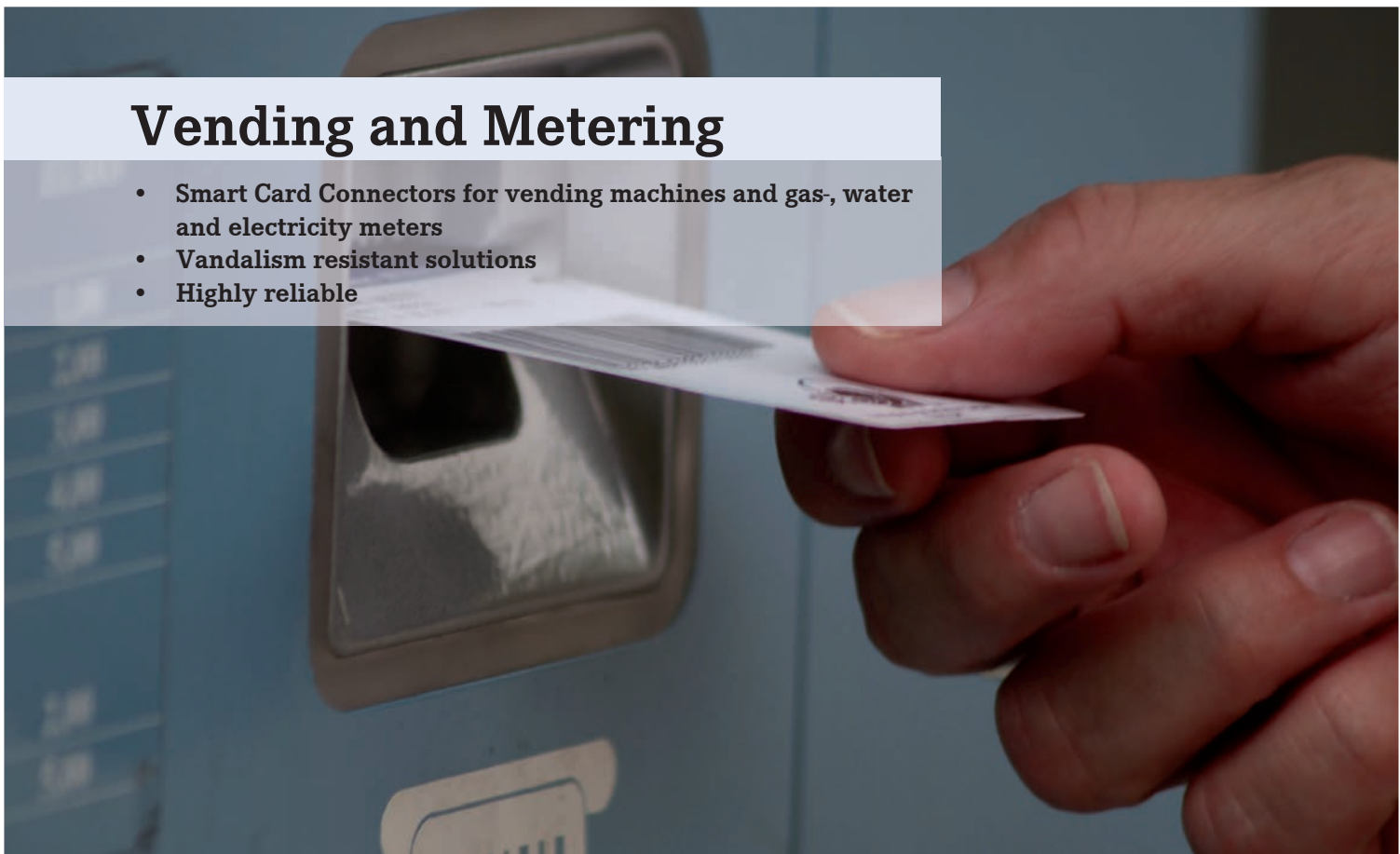

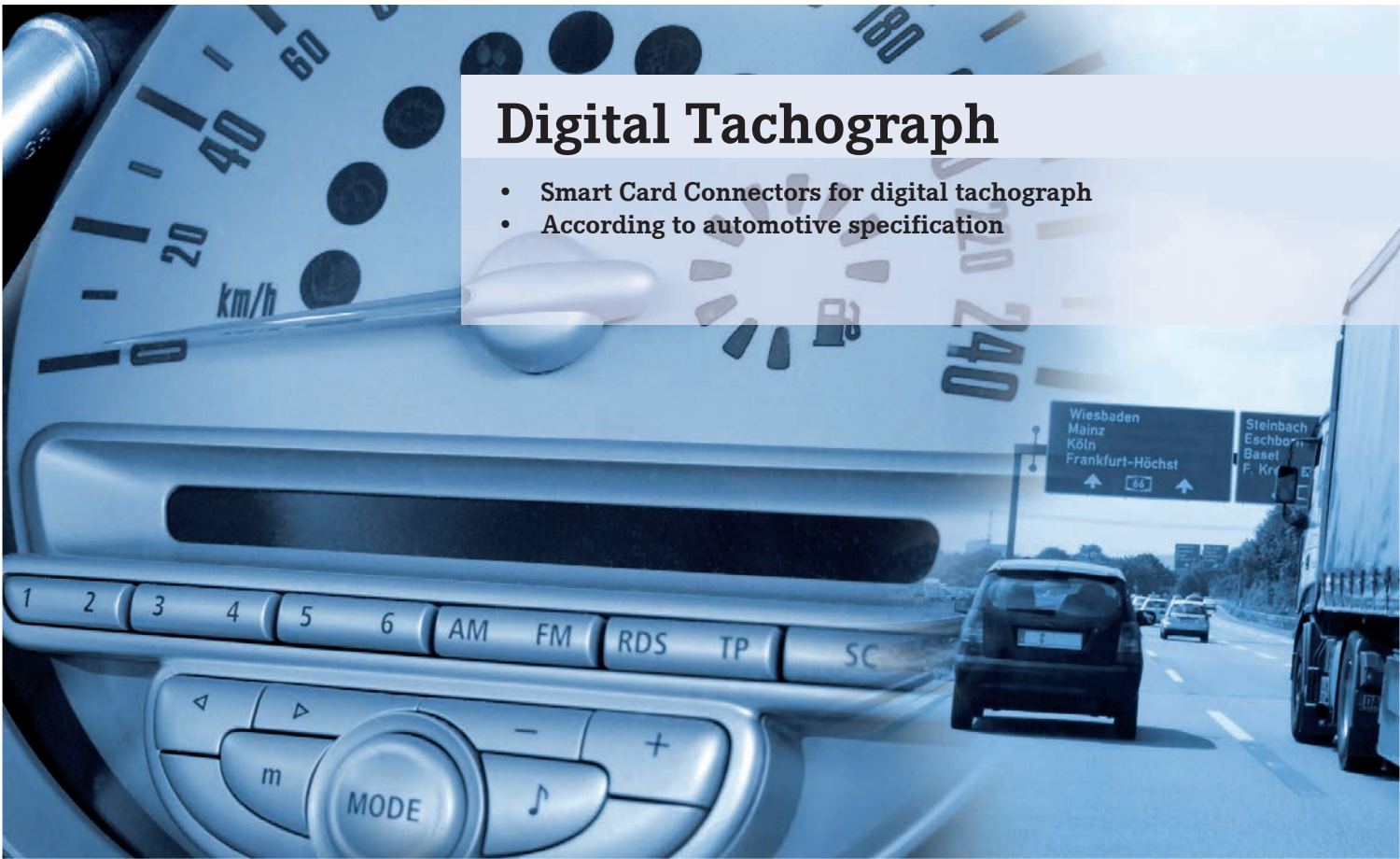

Digital Tachograph

- Smart Card Connectors for digital tachograph
- According to automotive specification



Digital Satellite Receivers

- Smart Card Connectors for digital satellite receivers and settop box (STB)
- High volume production

General Information Card Handling Systems

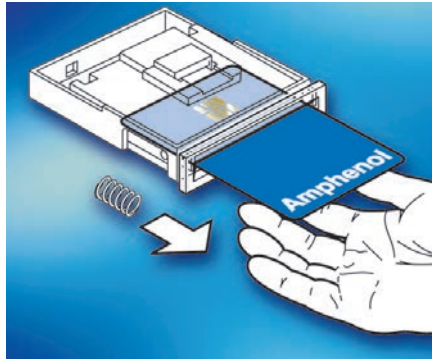
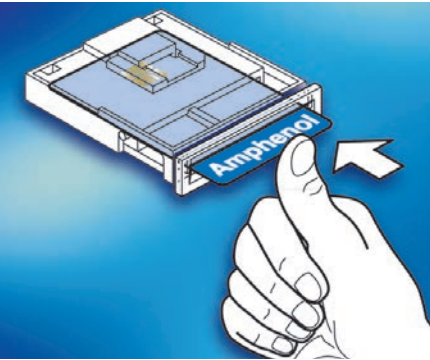

Push-Only

The card is inserted manually and held in the active position by hand. The card is ejected immediately after the user releases it. The Push-Only is ideally suited for applications with short transaction cycles, i.e. door access control.

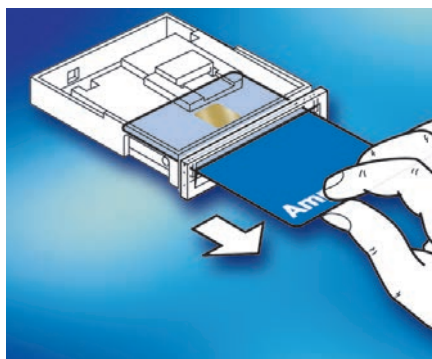
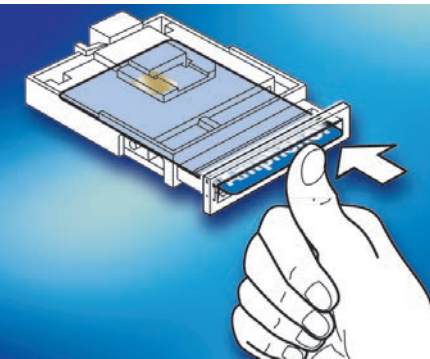

Push-Pull

The card is inserted manually and held in the active position by a card brake. After completion of the transaction, the card is simply pulled out of the Smart Card Connector.

This is the most common manual cardhandling system.

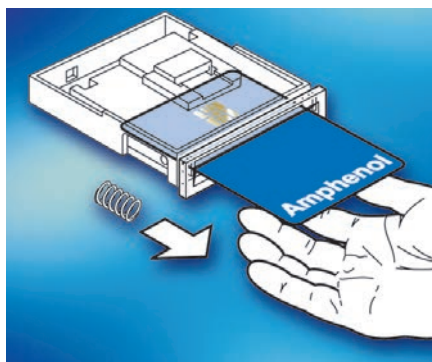
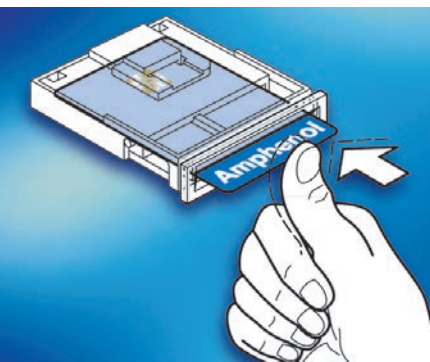

Push-Push

The card is inserted manually and held in the active position by the Smart Card Connector. When pushed again the card is returned to the user (principle of a ballpointpen).

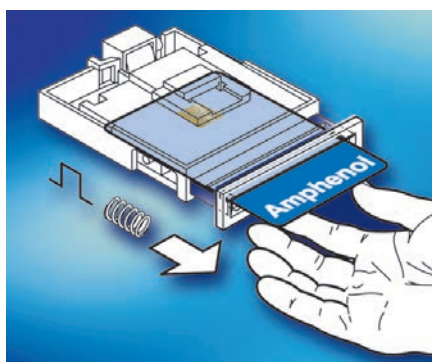
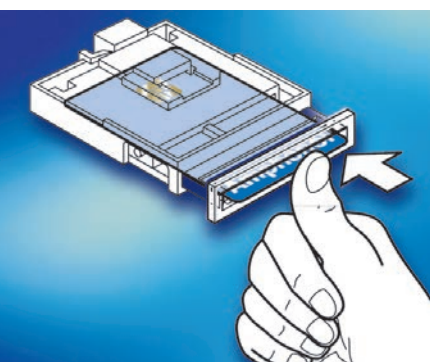

PUSHMATIC®

This semi-automatic system combines a manual card insertion with an automatic card ejection. The card is manually pushed into the Smart Card Connector until it is flush (or nearly flush) with the bezel.

Upon completion of the transaction, software triggers a solenoid and the card is ejected back to the user.

General Information Contact Methods

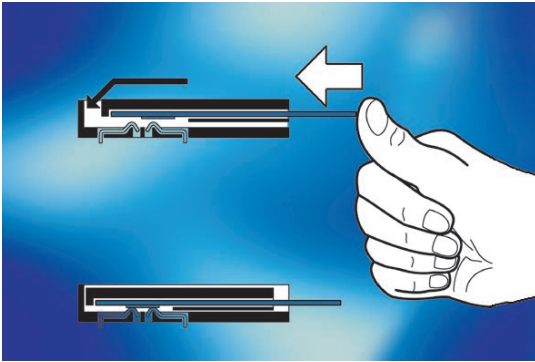

Landing Contacts

With this contact method a moveable contact set will connect with the pads of the chip card upon insertion of the card. The card plastic surface is not scratched and high mating cycles can be achieved.

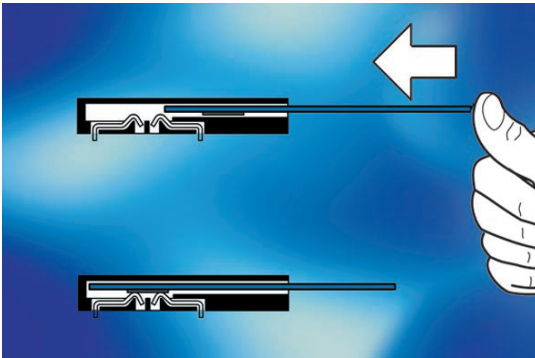

Wiping Contacts

The contact set is fixed. When the card is inserted, it wipes over the data contacts until they arrive at the card pads. Depending upon the card surface, wiping traces which do not influence the card function can occur after some insertion cycles.

The advantage of wiping contacts is that they clean the contact point with every mating cycle.

C703A Hybrid

C703A Hybrid Push-Pull

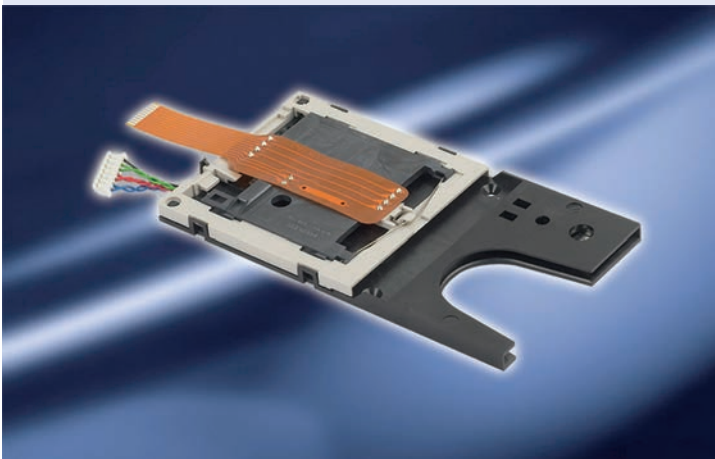

- 500.000 mating cycles for both chip and magnetic stripe
- landing, self-cleaning contacts
- gimballed magnetic head
- card presence switch
- compact design for space critical applications
- card guiding for secure card reading
- Europay Mastercard VISA compliant

PART NO.:

C703 10M008 600 5	standard magnetic head, with card break
C703 10M008 601 5	standard magnetic head, no card break
C703 10M008 609 5	superflat magnetic head, no card break

C703A Hybrid PUSHMATIC®

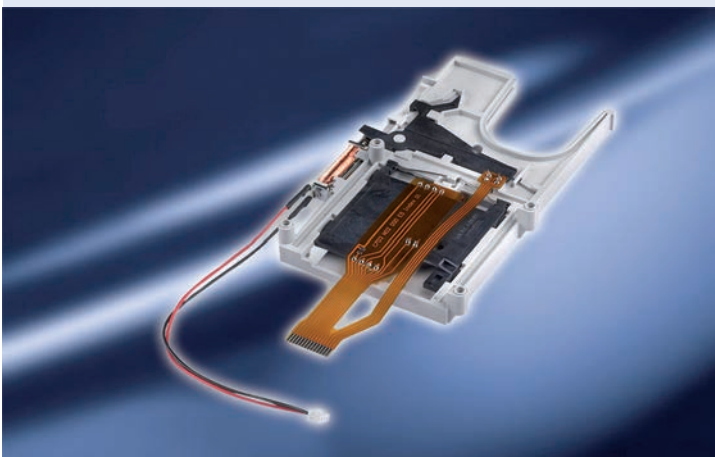

- 500.000 mating cycles for both chip and magnetic stripe
- landing, self-cleaning contacts
- gimballed magnetic head
- card presence and locking switch
- card locking in active position
- compact design for space critical applications
- card guiding for secure card reading
- Europay Mastercard VISA compliant

PART NO.:

C703 10M008 607 5	12V solenoid
-------------------	--------------

C702A Vario

C702A Vario



- 500.000 mating cycles
- landing, self-cleaning contacts
- card presence switch
- accessories available

PART NO.:

C702 10M008 015 2	Push-Push
C702 10M008 018 2	Push-Only
C702 10M008 514 2	Push-Pull

C702A PUSHMATIC®



- 500.000 mating cycles
- landing, self-cleaning contacts
- card presence switch
- accessories available

PART NO.:

C702 10M008 701 2	5V, flat cable termination
C702 10M008 700 2	12V, flat cable termination
C702 10M008 702 2	24V, flat cable termination
C702 10M008 732 2	5V, flat cable, locking detector
C702 10M008 716 2	12V, flat cable, locking detector

C702B PUSHMATIC® II

C702B PUSHMATIC® II without card locking



- robust design, suitable for vending machines
- card accessible during power failure
- card presence switch, also can be used for system wake up
- card end position switch acts as card locking sensor
- additional sensor for card active position detects abnormal termination of the transaction
- self retracting and self cleaning data contacts provide protection against vandalism
- housing bottom features a large debris slot allowing the egress of coins, paper, as well as cut in half cards
- 16 way interface header allows for custom cabling
- 300.000 mating cycles

PART NO.:

C702 10M008 906 2	5V	solenoid voltage
C702 10M008 904 2	12V	solenoid voltage
C702 10M008 909 2	24V	solenoid voltage

C702B PUSHMATIC® II with card locking

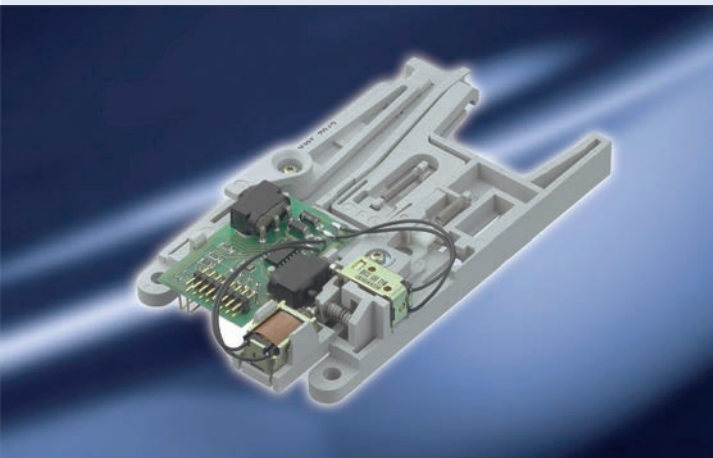

- card locked in active position
- robust design, suitable for vending machines
- card end position switch acts as card locking sensor
- additional sensor for card active position detects abnormal termination of the transaction
- self retracting and self cleaning data contacts provide protection against vandalism
- housing bottom features a large debris slot allowing the egress of coins, paper, as well as cut in half cards
- 16 way interface header allows for custom cabling
- 300.000 mating cycles
- as an option feature to release card in locked position (SCR)

PART NO.:

C702 10M008 907 2	5V	solenoid voltage
C702 10M008 905 2	12V	solenoid voltage
C702 10M008 910 2	24V	solenoid voltage

Accessories

C702A Accessories



- customized bezels on request

PART NO.:

C702 N13 030 E2 (for PUSHMATIC)	metal bezel, silver coloured
C702 N13 031 E2 (for PUSHMATIC)	metal bezel, black coloured
C702 N14 030 E2 (for PUSHMATIC)	metal bezel with coin spacer, silver coloured
C702 N15 100 G2	mounting plate
C702 N11 141 E2	plastic bezel, black
C702 N14 000 G2	Shutter

C702B Accessories

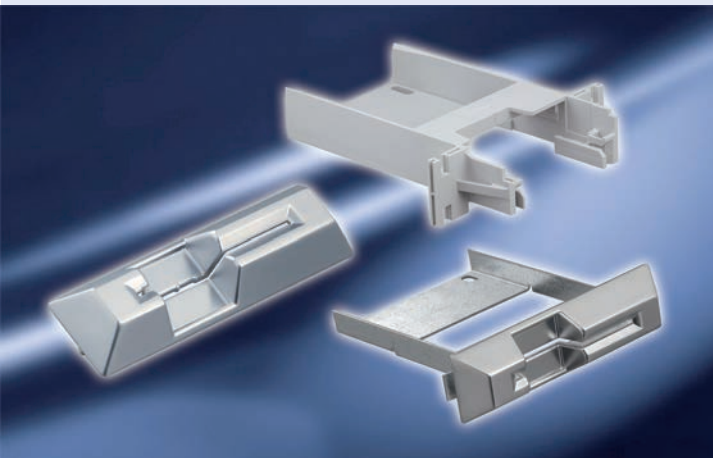

- Amphenol's original guarantees well function

PART NO.:

C702 G46 100 G2	metal bezel with "coin spacer" silver coloured
C702 G46 201 G2	metal bezel with "coin spacer" and rain refusing, silver coloured
C702 G51 112 E2	mounting plate, tin plated
C702 N25 040 E2	plastic adapter for common standard bezels

C702D Flex

C702D Flex Basis

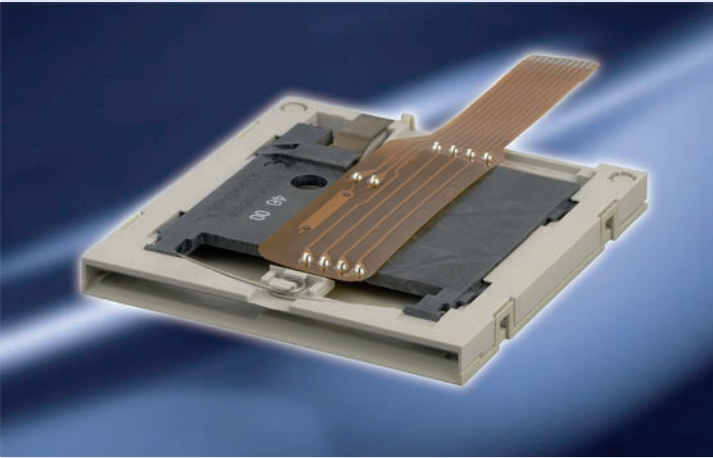

- miniaturized style, ideally suited for mobile devices like POS terminals
- 300.000 mating cycles
- with flexprint termination to save boardspace

PART NO.:

C702 10M008 065 4

C702D Flex Snap in

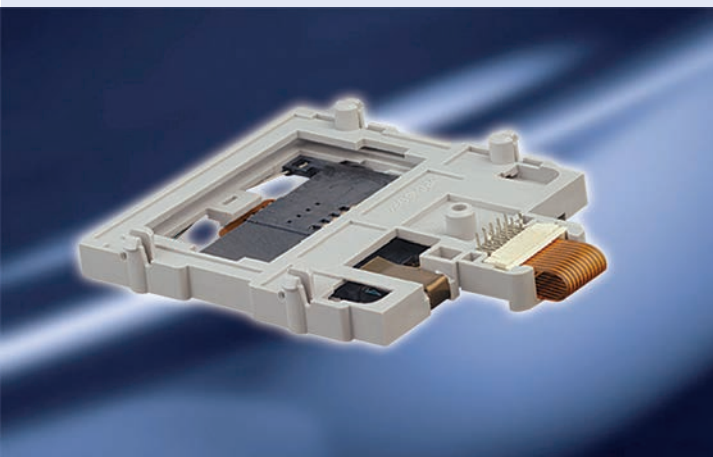

- snap in mounting, chip side up card insertion
- debris slot to provide egress of coins, paper
- miniaturized style, ideally suited for mobile devices like POS terminals
- 300.000 mating cycles
- with flexprint termination and as an option dip solder version

PART NO.:

C702 10M008 063 4

Dip Solder

C702 10M008 066 4

Flexprint

C702C PUSHMATIC® Slim

C702C PUSHMATIC® Slim

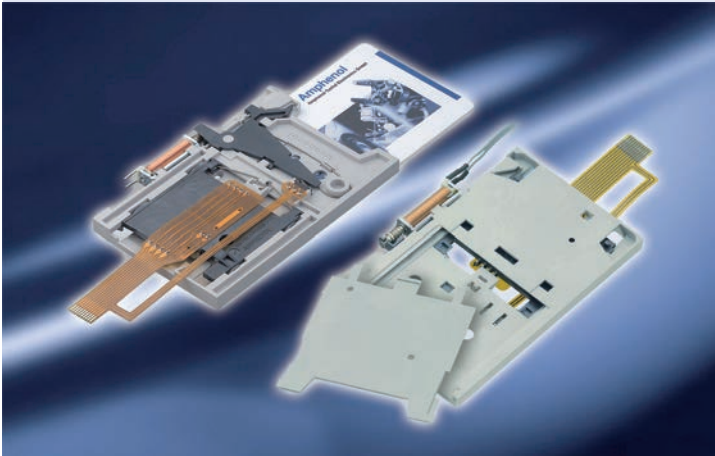

- 300.000 mating cycles
- landing, self-cleaning contacts
- card locking in active position
- automatic card ejection after transaction
- manual unlocking after power failure possible
- card presence and locking switch

PART NO.:

C702 10M008 901 4 5V
C702 10M008 902 4 12V

C702C Automotive Connector

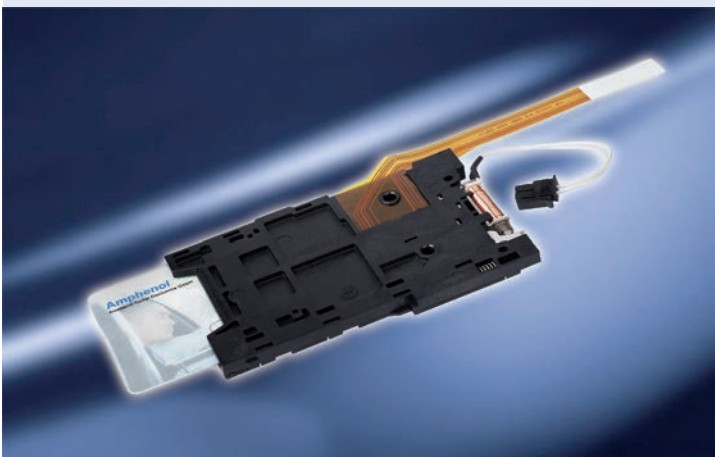

- designed for digital tachograph
- card locking
- ejection over solenoid
- integrated dust protection
- working temperature -40 °C – +85 °C
- shock resistance min. 20 G (in direction of solenoid axis)
- min. 25.000 mating cycles

PART NO.:

C702 10M008 925 4

C702E Wiping

C702E Wiping XXS



- self cleaning card present switch
- normally open or normally closed switch
- boardlocks for mechanical fixation
- special shape of contacts minimizes card scratching
- PCB mounting, dip solder pins
- dimensions 62x40x7.2 mm
- 100.000 mating cycles

PART NO.:

C702 10M008 230 40	XXS Standard, normally closed switch
C702 10M008 231 40	XXS Standard, normally open switch
C702 10M008 232 40	XXS 3mm stand-off, normally closed switch
C702 10M008 234 40	XXS 5mm stand-off, normally closed switch

C702G Wiping

C702G PCB-Slimline



- extremely compact dimensions (56 x 30 x 3 mm)
- metal cover for high mechanical stability (only one card in slot)
- protected switch
- for pick & place assembly
- reflow compliant
- 100,000 mating cycles

PART NO.:

C702 10M008 252 40	with position pins
--------------------	--------------------

C702F Card|mate®

C702F Card|mate®



- 500.000 mating cycles
- landing contacts
- very smooth card insertion
- reduced signs of wear on the smart card
- metal cover, low profile, high mechanical strength
- designed according to the Payment Card Industry requirements

PART NO.:

C702 10M008 320 4

C702Y Landing EZ

C702Y Landing EZ

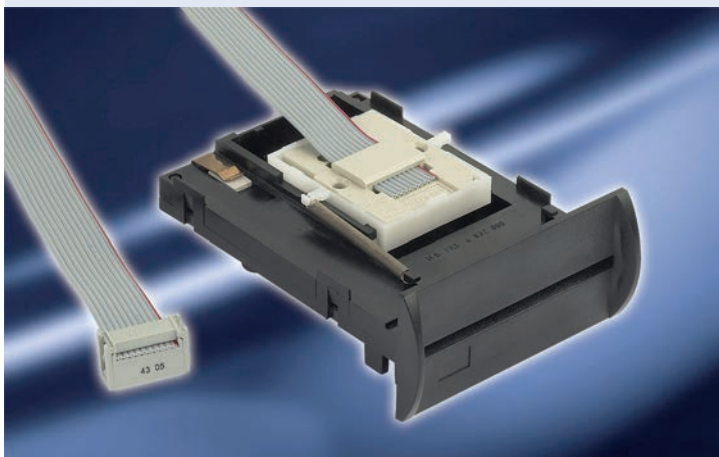

- 300.000 mating cycles
- landing, self-cleaning contacts
- card presence switch
- flat cable and flexprint termination

PART NO.:

C702 10M008 071 3 integrated bezel,
flat cable termination

C702 10M008 006 3 without bezel,
flat cable termination

International

Argentina

Amphenol Argentina
Av. Callao 930
2nd Floor Office B "Plaza"
C1023 AAP Buenos Aires
Phone +54 11 4815 68 86
www.amphenol.com.ar

Australia

Amphenol Australia Pty. Ltd.
2 Fiveways Blvd
Keysborough
Victoria 31 73
Phone +61 3 8796 88 88
www.amphenol.com.au

Brazil

Amphenol do Brasil Ltda.
Rua Diogo Moreira 132, 20th Floor
CEP 05423-101 Sao Paulo SP
Phone +55 11 3815 10 03
www.amphenol.com.br

China

Amphenol-Tuchel Electronics
China Branch
20 Tianshan Road
Changzhou 213022
Phone +86 519 8511 0301
www.amphenol.info

France

Amphenol Socapex S.A.S.
948, Promenade de l'Arve, BP 29
Thyez Cedex, 74311
Phone +33 4 5089 28 00
www.amphenol-socapex.com

Germany

Amphenol-Tuchel Electronics GmbH
August-Haessler-Str. 10
74080 Heilbronn
Phone +49 7131 929 0
www.amphenol.de

India

Amphenol Interconnect India Pvt Ltd
105, Bhosari Industrial Area
Pune - 411 026
Phone +91 20 2712 04 81
www.amphenol-in.com

Italy

Amphenol-Tuchel Italy
Via Barbaiana n. 5
20020 Lainate (MI)
Phone +39 02 9325 41
www.amphenol.info

Korea

Amphenol DaeShin Elect and
Precision Co.,Ltd
558 Songnae-Dong, Sosa-Gu
Bucheon-City, Kyunggi-Do
Korea 422-130
Phone +82 32 6103 800
www.amphenol.co.kr

Mexico

Amphenol Mexico
Prolongacion Reforma 61 - 6 B2
Col. Paseo de las Lomas
C.P. 01330 Mexico D.F.
Phone +52 55 5258 99 84
www.amphenolmexico.com

Singapore

Asia Pacific Sales Operations
72 Bendemeer Rd, No.03-32/33
Hiap Huat House, Luzerne, 339941
Singapore
Phone +65 6294 21 28
www.amphenol.com

South Africa

Amphenol International Ltd
Chislehurst
30 Impala Road
2196 Chislehurst
Sandton, 2146
Phone +27 11 7839 517
www.amphenol.co.za

Spain

Amphenol Espana
Edificio Burgosal, Oficina 55
C/Comunidad de Madrid, 35 bis
Las Rozas (Madrid), 28230
Phone +34 91 6407 302
www.amphenol.com

Taiwan

Amphenol East Asia Limited-Taiwan
5F, No 361, Fusing 1st Rd
Gueishan Township,
Taoyuan County 333
Phone +886 3 2647 200
www.amphenol.com

More Amphenol companies can be
found here: www.amphenol.com

Turkey

Amphenol Turkey
Sun Plaza Kat: 15
Maslak Mah. Bilim Sok.No:15
34398 Sisli - Istanbul
Phone: +90 2123 679 220
www.amphenol.com.tr

United Kingdom

Amphenol Limited
Thanet Way, Whitstable
Kent, CT53JF
Phone +44 1227 773 200
www.amphenol.co.uk

USA

Amphenol-Tuchel Electronics
6900 Haggerty Road
Suite 200
Canton, Michigan 48187
Phone +1 7344 516 400
www.amphenol.info

Amphenol Corporation
Corporate Headquarters
358 Hall Avenue
Wallingford, CT 06492
Phone +1 877 2674 366
Phone +1 203 2658 900
www.amphenol.com



Important Notice

All technical data have been measured in a laboratory environment and can be different during practical usage of the product. Any product information is for descriptive usage only and not legally binding; particularly the information does not constitute or provide any legal guarantees ("Beschaffenheitsgarantie" or "Haltbarkeitsgarantie").

We reserve the right to change the design due to improvement in quality, development or production requirements. This catalogue must not be used in any form or manner without our prior approval in writing (Copyright Law, Fair Trading Law, Civil Code).

Your engineering sales representative:

X-ON Electronics

Largest Supplier of Electrical and Electronic Components

Click to view similar products for [Memory Card Connectors](#) category:

Click to view products by [Amphenol](#) manufacturer:

Other Similar products are found below :

[M21-033321-005](#) [6407-249V-25273P](#) [6407-249V-25343P](#) [6426-201-21343](#) [69.920.0553.0](#) [FCN-568P068-G/07-4V](#) [809180410000000](#)
[N7E50-7516PG-20-WF](#) [21920-5](#) [2041353-2](#) [33CFAE-DN](#) [502431-1011](#) [EN2997S61212BN](#) [EN2997SE61212BN](#) [95622-003LF](#) [N7E50-](#)
[U516RB-50-SIN0005](#) [95079-00CALF](#) [84648-056HLF](#) [68-580163-21S](#) [33DVIR-29S12R](#) [125A-78C00](#) [MI20A-50PD-SF-EJL\(71\)](#) [KP10S-SF-](#)
[PEJ\(812\)](#) [504536-0691](#) [504580-0691](#) [CCM03-3109 B LFT](#) [2309923-1](#) [61126-050CAHLF](#) [IC1GA-68PD-1.27DS-EJ\(72\)](#) [GTFP08432B1HR](#)
[G85DT17001P1EU](#) [G85B21611142HHR](#) [GSD090144HR](#) [G85D1140022P1HR](#) [GMCB05801124EU](#) [112K-TAA0-RA1](#) [115S-ACA2](#) [115S-](#)
[ACA3](#) [115S-BS00](#) [115S-BT00](#) [115V-AD00](#) [MCSP-Q1-08-A-SG-T/R](#) [503960-0695](#) [101B-TAA0-R](#) [101D-TAAA-R01](#) [101D-TAAB-R01](#)
[104D-TCA0-R06](#) [104B-TAA0-R](#) [112C-TBAR-R02](#) [114B-40B00-R02](#)