

THIS DOCUMENT IS SUBJECT TO CHANGE WITHOUT NOTICE. IT IS CONFIDENTIAL AND A PROPERTY OF Amphenol LTW. DISCLOSURE TO THIRD PARTY HAS TO BE AUTHORIZED BY Amphenol LTW.

REV.	ECN NO.	DATE	SIGN	DESCRIPTION
A	Initial Release	2018/03/14	Mafei	Change Rev.01 To Rev.A

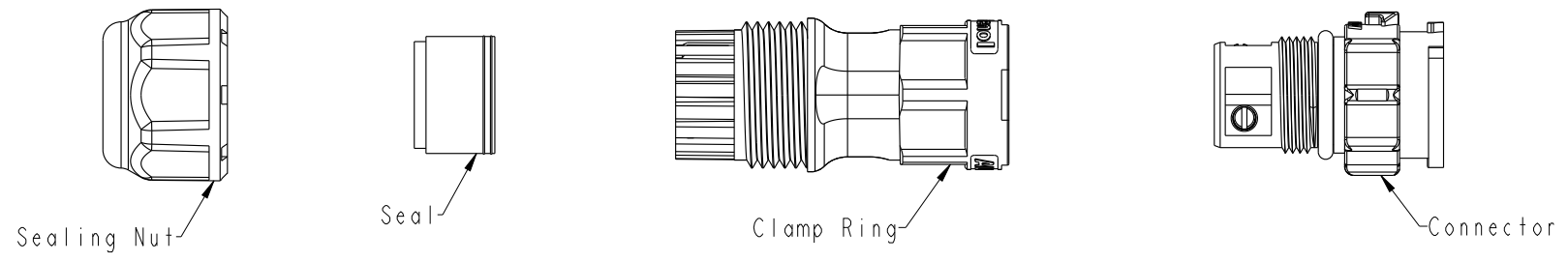

Material Specification:

- * Connector: Thermoplastic
- * Terminal: Copper Alloy, Gold Plated.
- * Gasket & O-Ring: Rubber.
- * UL Rated: UL 94V-0, fl.
- * RoHS Compliant.

Electrical Specification:

- * Contact Resistance: 10mΩ Max.
- * Insulation Resistance: 100MΩ Min.
- * Dielectric Withstand Voltage: 1,600 Vac.

Mechanical Specification:

- * Durability: 1000 Cycles.
- * Tensile strength: 10 kgf.
- * Wire conductor: 14AWG~12AWG(2.0mm²~3.3mm²).
- * Wire insulation OD: Max 4.0mm.
- * Torque Force for Clamp Ring: 6~8 kgf-cm
- * Torque Force for Seal Nut: 8~15 kgf-cm

Environmental Specification:

- * Waterproof Rating: IP68(Mated, 1M/24 Hours)
- * Temperature Range: -40°C to 105°C.
- * Salt Spray: Mated, 500 Hours.
- * Safety Compliance: UL 1977.

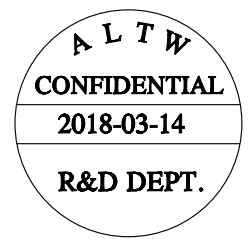
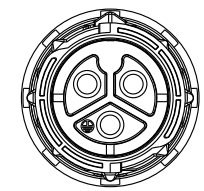
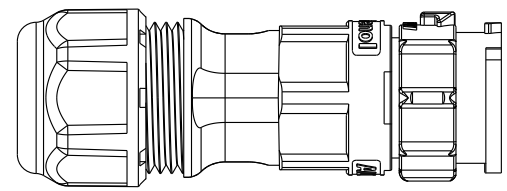
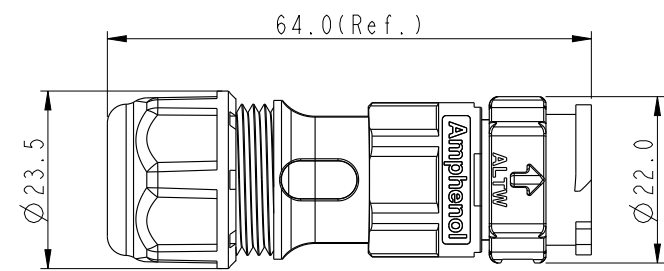

UNIT:mm			TITLE
TOLERANCE	±0.5 mm		X-Lok C-Size Field Installable Cable Screw-in Type M Conn F Pin
SCALE	8:5	SIZE	A4
SHEET	1	OF	2
REV.	A	WC-REV.	A.3
☉: Inspection item			

Amphenol LTW
安費諾亮泰企業股份有限公司

ITEM NO.	DRAWN BY	DATE
	Mafei	2018-03-14
DWG NO.	CHECKED BY	DATE
CC-XXBMFB-QL8XPP	Jerry	2018-03-14
CUSTOMER	APPROVED BY	DATE
ALTW	Max	2018-03-14

THIS DOCUMENT IS SUBJECT TO CHANGE WITHOUT NOTICE. IT IS CONFIDENTIAL AND A PROPERTY OF Amphenol LTW. DISCLOSURE TO THIRD PARTY HAS TO BE AUTHORIZED BY Amphenol LTW.

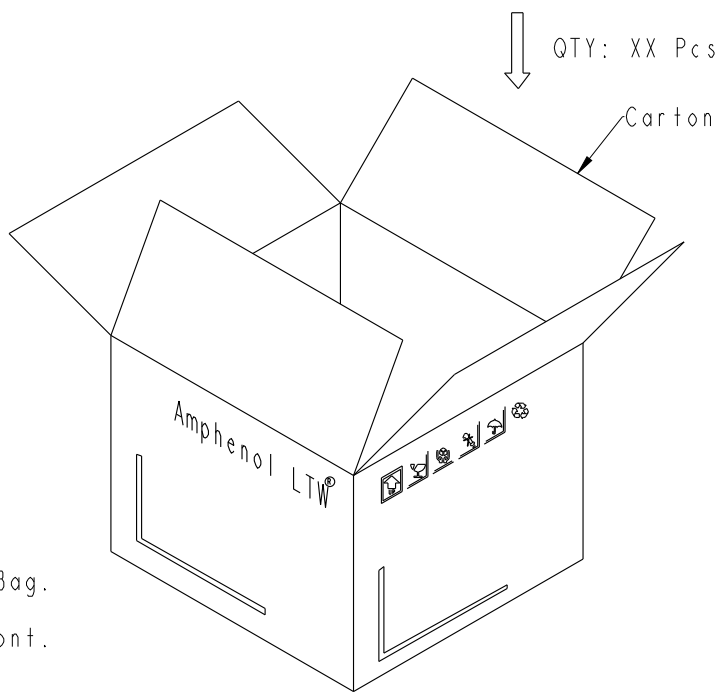
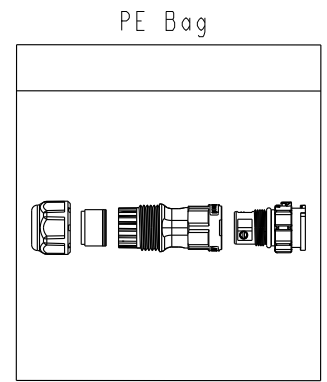
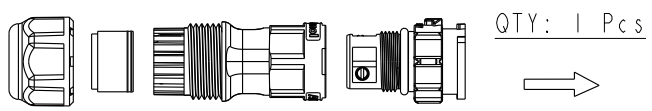

Ordering Information:

CC-XXBMFB-QLXPP

Number of Contacts

02
03

- S: With Red Color Seal 1, Cable OD 6.0~8.0mm.
- M: With Yellow Color Seal 2, Cable OD 8.0~10.0mm.
- L: With Blue Color Seal 3, Cable OD 10.0~12.0mm.
- A: With Seal 1 & Seal 2 & Seal 3.

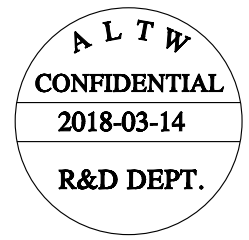
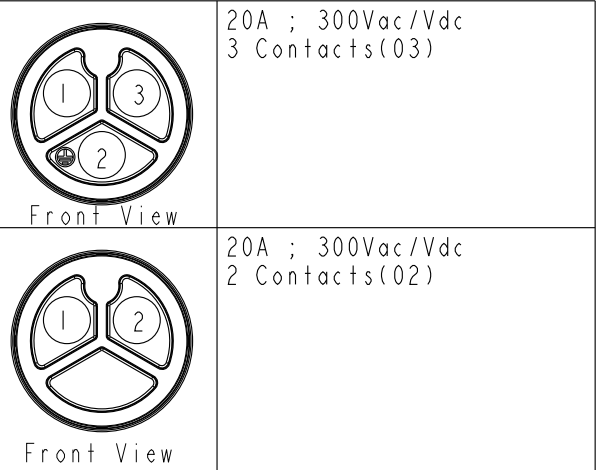

- Note:
- * One Set Unassembled In One PE Bag.
(每一組未組裝, 放置於一個PE袋, 並封口, 如圖示)
 - * Label is Attached To PE Bag Front.
(標籤貼在PE袋正面)

UNIT:mm		TITLE	X-Lok C-Size Field Installable Cable Screw-in Type M Conn F Pin	
TOLERANCE	±0.5 mm	SCALE	8:5	SIZE A4
		REV.	A	WC-REV. A.3
			SHEET 2 OF 2	
			☉: Inspection item	

Amphenol LTW
安費諾亮泰企業股份有限公司

ITEM NO	CC-XXBMFB-QL8XPP	DRAWN BY	Mafei	DATE	2018-03-14
DWG NO	ALTW	CHECKED BY	Jerry	DATE	2018-03-14
CUSTOMER	ALTW	APPROVED BY	Max	DATE	2018-03-14

X-ON Electronics

Largest Supplier of Electrical and Electronic Components

Click to view similar products for [Circular Metric Connectors](#) category:

Click to view products by [Amphenol](#) manufacturer:

Other Similar products are found below :

[600X518037X](#) [6STD15PCR99B70A](#) [8R4000A16M020](#) [8R5000A16M005](#) [1200910002](#) [1203580030](#) [1200910008](#) [1200910011](#) [1300140094](#)
[130203-0054](#) [1300140026](#) [1300150099](#) [1-3637-600-5205](#) [1612618](#) [21036836414](#) [8R4006A16M010](#) [1R3006A20M005](#) [41-40011](#) [42-00006](#)
[42-01015](#) [4-22279-4](#) [4-22281-1](#) [4-22284-9](#) [43-00113](#) [43-01203](#) [41-40013](#) [42-00008](#) [43-00343](#) [43-01026](#) [43-01162](#) [43-01173](#) [43-10000](#)
[XS3P-M421-2](#) [600X518050X](#) [8R5006A16M020](#) [8R5006A16M005](#) [8R4000A16M010](#) [6-22279-3](#) [1605332](#) [N03FA03144](#) [1300140077](#) [43-](#)
[16213](#) [43-01338](#) [XS2RD4265](#) [XS2R-D426-1](#) [XS8A-0441](#) [859RD04-103R004](#) [860RD04-113R004](#) [860RD04-213R004](#) [1-213245-2](#)