

THIS DOCUMENT IS SUBJECT TO CHANGE WITHOUT NOTICE. IT IS CONFIDENTIAL AND A PROPERTY OF AMPHENOL LTW. DISCLOSURE TO THIRD PARTY HAS TO BE AUTHORIZED BY AMPHENOL LTW.

REV.	ECN NO.	DATE	SIGN	DESCRIPTION
A	Initial Release	2018/06/20	Mafei	Change Rev.01 To Rev.A

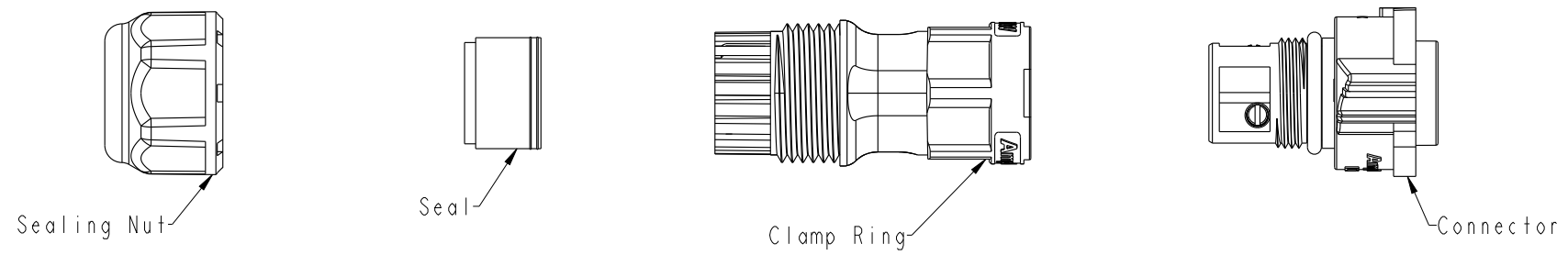

**Material Specification:**

- \* Connector: Thermoplastic
- \* Terminal: Copper Alloy, Gold Plated.
- \* Gasket & O-Ring: Rubber.
- \* UL Rated: UL 94V-0, fl.
- \* RoHS Compliant.

**Electrical Specification:**

- \* Contact Resistance: 10mΩ Max.
- \* Insulation Resistance: 100MΩ Min.
- \* Dielectric Withstand Voltage: 1,600 Vac.

**Mechanical Specification:**

- \* Durability: 1000 Cycles.
- \* Tensile strength: 10 kgf.
- \* Wire conductor: 14AWG~12AWG(2.0mm<sup>2</sup>~3.3mm<sup>2</sup>).
- \* Wire insulation OD: Max 4.0mm.
- \* Torque Force for Clamp Ring: 6~8 kgf-cm
- \* Torque Force for Seal Nut: 8~15 kgf-cm
- \* Torque Force for Screw: 4~5 kgf-cm

**Environmental Specification:**

- \* Waterproof Rating: IP68(Mated, 1M/24 Hours)
- \* Temperature Range: -40°C to 105°C.
- \* Salt Spray: Mated, 500 Hours.
- \* Safety Compliance: UL 1977.

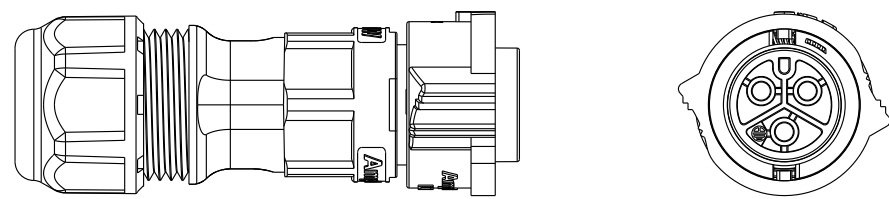
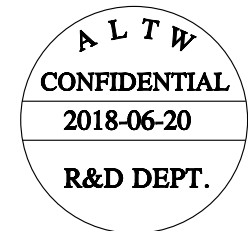
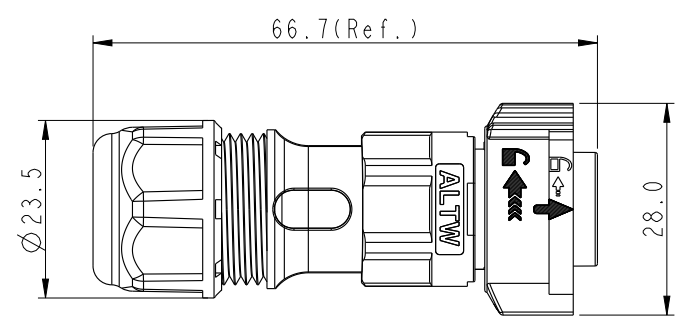

UNIT:mm		TITLE	X-Lok C-Size Field Installable Cable Screw-in Type F Conn M Pin	
TOLERANCE	±0.5 mm	SCALE	8:5	SIZE A4
		REV.	A	WC-REV. A.3
				SHEET 1 OF 2
				QC: Inspection item

**Amphenol LTW**  
安費諾亮泰企業股份有限公司

ITEM NO	DWG NO	CUSTOMER	DRAWN BY	CHECKED BY	APPROVED BY	DATE
	CC-XXBFMB-QL8XPP	ALTW	Mafei	Jerry	Max	2018-06-20
						2018-06-20
						2018-06-20

THIS DOCUMENT IS SUBJECT TO CHANGE WITHOUT NOTICE. IT IS CONFIDENTIAL AND A PROPERTY OF Amphenol LTW. DISCLOSURE TO THIRD PARTY HAS TO BE AUTHORIZED BY Amphenol LTW.

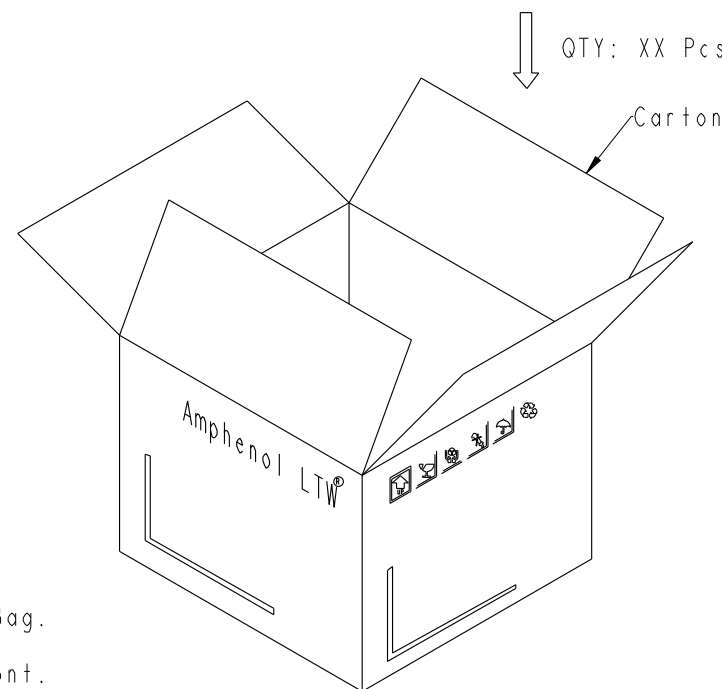
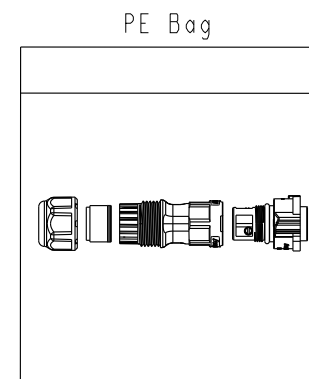
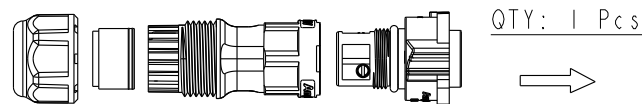

Ordering Information:

CC-XXBFMB-QL8XPP

Number of Contacts

02  
03

S: With Red Color Seal 1, Cable OD 6.0~8.0mm.  
 M: With Yellow Color Seal 2, Cable OD 8.0~10.0mm.  
 L: With Blue Color Seal 3, Cable OD 10.0~12.0mm.  
 A: With Seal 1 & Seal 2 & Seal 3.

 Front View	20A ; 300Vac/Vdc 3 Contacts(03)
 Front View	20A ; 300Vac/Vdc 2 Contacts(02)

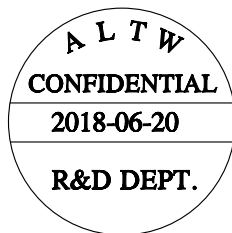

Note:

- \* One Set Unassembled In One PE Bag.  
(每一組未組裝，放置於一個PE袋，並封口，如圖示)
- \* Label is Attached To PE Bag Front.  
(標籤貼在PE袋正面)

UNIT:mm		TITLE X-Lok C-Size Field Installable Cable Screw-in Type F Conn M Pin	
TOLERANCE ±0.5 mm		SCALE 8:5	SIZE A4
REV. A	WC-REV. A.3	SHEET 2 OF 2	QC: Inspection item

**Amphenol LTW**  
 安費諾亮泰企業股份有限公司

ITEM NO	DRAWN BY Mafei	DATE 2018-06-20
DWG NO CC-XXBFMB-QL8XPP	CHECKED BY Jerry	DATE 2018-06-20
CUSTOMER ALTW	APPROVED BY Max	DATE 2018-06-20

## X-ON Electronics

Largest Supplier of Electrical and Electronic Components

*Click to view similar products for [Circular Metric Connectors](#) category:*

*Click to view products by [Amphenol](#) manufacturer:*

Other Similar products are found below :

[600X518037X](#) [6STD15PCR99B70A](#) [8R4000A16M020](#) [8R5000A16M005](#) [1200910002](#) [1203580030](#) [1200910008](#) [1200910011](#) [1300140094](#)  
[130203-0054](#) [1300140026](#) [1300150099](#) [1-3637-600-5205](#) [1612618](#) [21036836414](#) [8R4006A16M010](#) [1R3006A20M005](#) [41-40011](#) [42-00006](#)  
[42-01015](#) [4-22279-4](#) [4-22281-1](#) [4-22284-9](#) [43-00113](#) [43-01203](#) [41-40013](#) [42-00008](#) [43-00343](#) [43-01026](#) [43-01162](#) [43-01173](#) [43-10000](#)  
[XS3P-M421-2](#) [600X518050X](#) [8R5006A16M020](#) [8R5006A16M005](#) [8R4000A16M010](#) [6-22279-3](#) [1605332](#) [N03FA03144](#) [1300140077](#) [43-](#)  
[16213](#) [43-01338](#) [XS2RD4265](#) [XS2R-D426-1](#) [XS8A-0441](#) [859RD04-103R004](#) [860RD04-113R004](#) [860RD04-213R004](#) [1-213245-2](#)