

THIS DOCUMENT IS SUBJECT TO CHANGE WITHOUT NOTICE. IT IS CONFIDENTIAL AND A PROPERTY OF Amphenol LTW. DISCLOSURE TO THIRD PARTY HAS TO BE AUTHORIZED BY Amphenol LTW.

REV.	ECN NO.	DATE	SIGN	DESCRIPTION
A	Initial Release	2018/03/14	Mafei	Change Rev.01 To Rev.A
B	E191814	2019/10/23	Ruru	$\triangle B$ X3

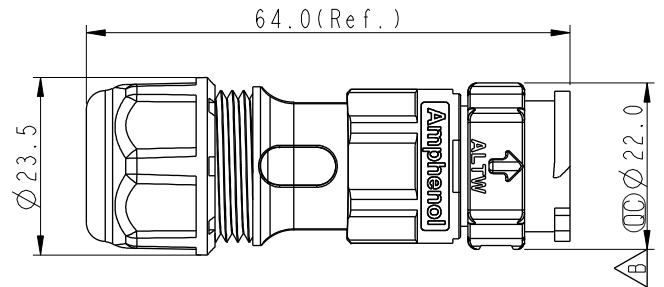
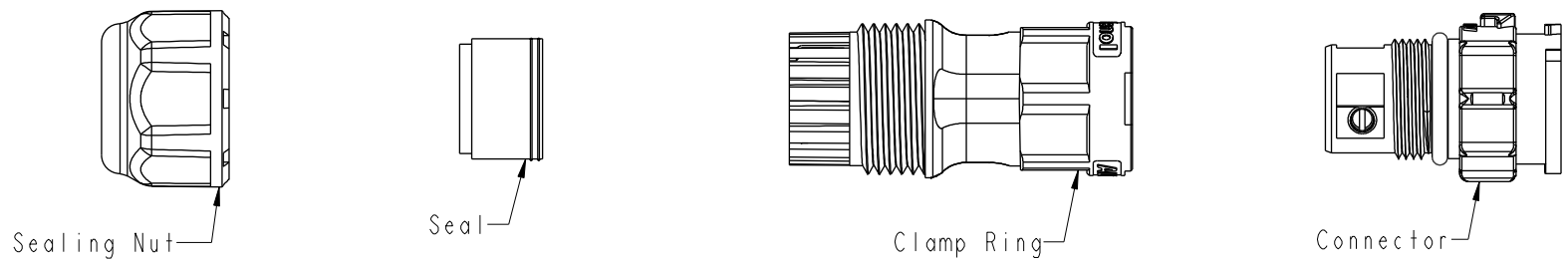

CC-XXBMMB-QLXPP
 02-2 Pin
 03-3 Pin

S: With Red Color Seal 1, Cable OD 6.0~8.0mm.
 M: With Yellow Color Seal 2, Cable OD 8.0~10.0mm.
 L: With Blue Color Seal 3, Cable OD 10.0~12.0mm.
 A: With Seal 1 & Seal 2 & Seal 3.

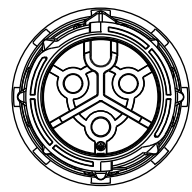
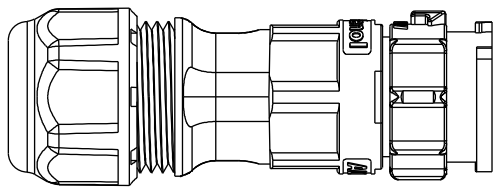

Pin Assignments Front View



2 Pin

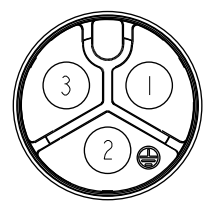

3 Pin

- $\triangle B$ Note:
- * \varnothing Important Dimension
 - * Waterproof Rate: IP68, Mated
 - IP68 : IM Depth Of Water In 24hours
 - * Housing: Thermoplastic, Black
 - * Pin: Copper Alloy, Gold Plated
 - * Clamp Ring: Thermoplastic, Black
 - * Sealing Nut: Thermoplastic, Black
 - * Seals: Rubber

UNIT:mm		TITLE XLOK, C-20A, 02P, CABLE W/O SR M, M, FI SCREW IN, XLOK $\triangle B$
TOLERANCE ± 0.5 mm	SCALE 8:5	SIZE A4
	REV. B	SHEET 1 OF 2
	WC-REV. A.3	\varnothing : Inspection item

Amphenol LTW
 安費諾亮泰企業股份有限公司

ITEM NO	DRAWN BY Mafei	DATE 2018-03-14
DWG NO CC-XXBMMB-QL8XPP	CHECKED BY Jerry	DATE 2018-03-14
CUSTOMER ALTW	APPROVED BY Max	DATE 2018-03-14

THIS DOCUMENT IS SUBJECT TO CHANGE WITHOUT NOTICE. IT IS CONFIDENTIAL AND A PROPERTY OF Amphenol LTW. DISCLOSURE TO THIRD PARTY HAS TO BE AUTHORIZED BY Amphenol LTW.

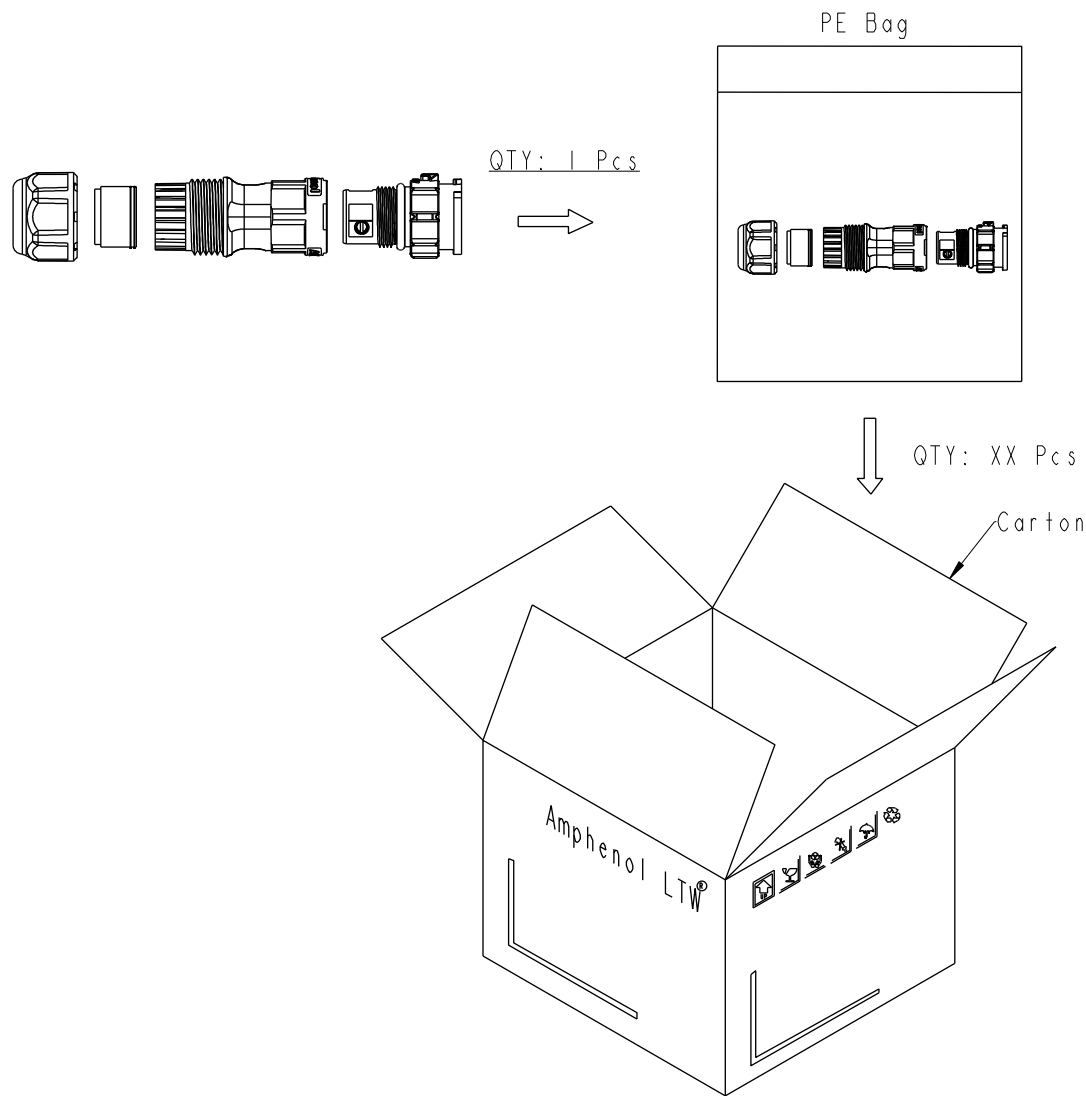

Note:
 * One Set Unassembled In One PE Bag.
 (每一組未組裝，放置於一個PE袋，並封口，如圖示)
 * Label is Attached To PE Bag Front.
 (標籤貼在PE袋正面)

UNIT:mm 
 TOLERANCE
 ±0.5 mm

TITLE XLOK, C-20A, 02P, CABLE W/O SR M, M, FI SCREW IN, XLOK 			
SCALE 8:5	SIZE A4	SHEET 2 OF 2	
REV. B	WC-REV. A.3	QC: Inspection item	

Amphenol LTW
 安費諾亮泰企業股份有限公司

ITEM NO	DRAWN BY Mafei	DATE 2018-03-14
DWG NO CC-XXBMMB-QL8XPP	CHECKED BY Jerry	DATE 2018-03-14
CUSTOMER ALTW	APPROVED BY Max	DATE 2018-03-14

X-ON Electronics

Largest Supplier of Electrical and Electronic Components

Click to view similar products for [Standard Circular Connector](#) category:

Click to view products by [Amphenol](#) manufacturer:

Other Similar products are found below :

[5M2530B10P](#) [600259N006](#) [600273N007](#) [6134-336-13149](#) [6134-337-11149](#) [6134-337-2390](#) [6134-341-17149](#) [6280-4SG-516](#) [6280-7SG-3DC](#)
[6290](#) [6291A](#) [66200A-10](#) [680-SMG](#) [681-PMG](#) [CXS3102A14S2P](#) [CXS3102A181S](#) [7251-6SG-300](#) [7271-6SG-300](#) [7282-3PG-300-CH3](#) [75-](#)
[474014-05S](#) [75-474618-01S](#) [75-474618-04P](#) [75-474618-04S](#) [799539-000](#) [MI8-SE](#) [805-005-07NF11-19PC](#) [805-005-07NF15-7PA](#) [8280-4PG-](#)
[516](#) [8280-7PG-519](#) [8282-5PG-519](#) [836783-1](#) [MP-4102-25P-C](#) [862256-1](#) [864019-2](#) [866857-1](#) [867865-1](#) [PT01SP-14-18P](#) [PT08P-14-5S](#)
[PTSF06SE-14-12S](#) [120-1833-000](#) [QCM019PC2DC012B](#) [1-2069279-1](#) [121583-0217](#) [121667-0020](#) [129591AU](#) [1000B BULK](#) [RD10A16-19-](#)
[P6CS051/1](#) [RD10A20-31-P8CS051/1](#) [RD16A14-12-S6CS051/2](#) [1301240290](#) [1301240347](#)