

THIS DOCUMENT IS SUBJECT TO CHANGE WITHOUT NOTICE. IT IS CONFIDENTIAL AND A PROPERTY OF AMPHENOL LTW. DISCLOSURE TO THIRD PARTY HAS TO BE AUTHORIZED BY AMPHENOL LTW.

REV.	ECN NO.	DATE	SIGN	DESCRIPTION
B	LE31570312~13	2015/07/18	Lu Di	Change To Common drawing
C	LEN15B0356-360	2015/11/10	Joy	Add 7-8 And 9 Pin To The Common Drawing

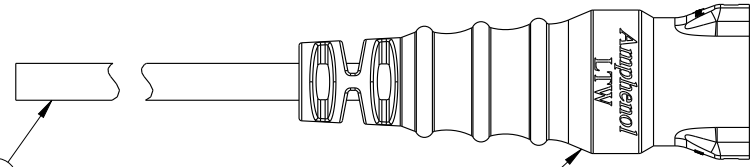
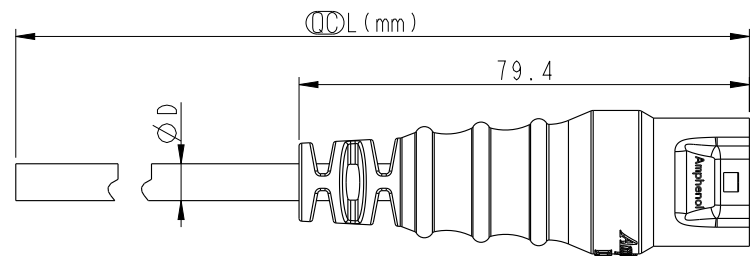
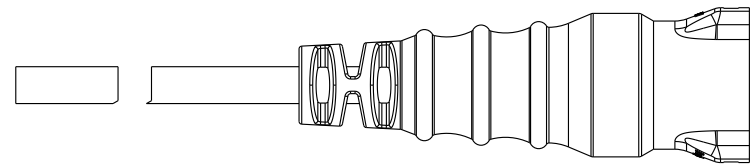

Cable ②

CD-XXAFMM-RL7000 ①  
Color: Black

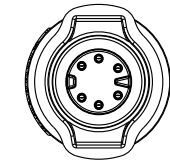
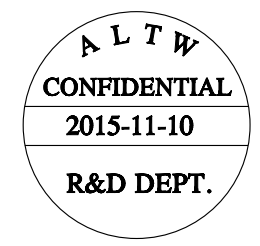
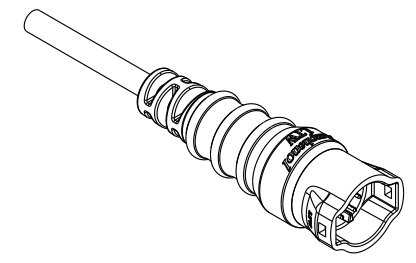

Conn

B/C

CD-02AFMM-RL7AXX	
CD-03AFMM-RL7AXX	$\phi 5.5$
CD-04AFMM-RL7AXX	
CD-05AFMM-RL7AXX	$\phi 6.0$
CD-06AFMM-RL7AXX	$\phi 6.5$
CD-07AFMM-RL7AXX	
CD-08AFMM-RL7AXX	$\phi 6.8$
CD-09AFMM-RL7AXX	$\phi 7.4$
Part No.	Cable OD

Note:

- \*  $\phi$  Important Dimension To Check.
- \* Waterproof Rate: IP67
- \* Housing: M-PPE, Black.
- \* Male Pin: Copper Alloy, Gold Plated.
- \* Cable: UL2464 20#, PVC Jacket, UV Resistant, Black.
- \* Cable Length Tolerance:
  - 01M~40mm
  - 02M~05M:  $\pm 60$ mm
  - 06M~10M:  $\pm 100$ mm
  - 11M~30M:  $\pm 200$ mm
  - 31M~99M:  $\pm 500$ mm
- \* Prohibiting the use of place in oils

UNIT: mm	TOLERANCE	TITLE	SCALE	SIZE	SHEET	OF
$\pm 0.5$		MIDDLE CABLE RBL F CONN M PIN	3:4	A4	1	2
		REV. C	WC-REV. A.3	QC: Inspection item		

**Amphenol LTW**  
安費諾亮泰企業股份有限公司

ITEM NO.	DRAWN BY	DATE
	Joy	2015-11-10
DWG NO.	CHECKED BY	DATE
CD-XXAFMM-RL7AXX	Lu Di	2015-11-10
CUSTOMER	APPROVED BY	DATE
ALTW	Jerry	2015-11-10

A

THIS DOCUMENT IS SUBJECT TO CHANGE WITHOUT NOTICE. IT IS CONFIDENTIAL AND A PROPERTY OF Amphenol LTW. DISCLOSURE TO THIRD PARTY HAS TO BE AUTHORIZED BY Amphenol LTW.

△B

CD-XXAFMM-RL7A XX

Middle Size Current Rating 5A

XX:No. Of Pin (Pin 數)

A:Cable With S/R(線端帶網尾)

F:Female Connector(母座)

M:Male Pin(公Pin)

M:Molding Type(射出成型)

XX:01~99Meter

01:01Meter

02:02Meter

...

99:99Meter

A:UL 2464 Cable

7:IP67(防水等級 67)

L:Straight(180°)

R:Snap In With Latch(彈臂卡合式)

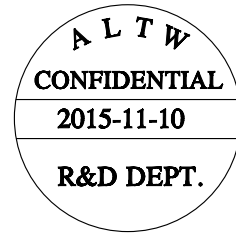

9	White	白	9	--	
8	Purple	紫	8	Purple	紫
7	Red	紅	7	Red	紅
6	Green	綠	6	Green	綠
5	Yellow	黃	5	Yellow	黃
4	Blue	藍	4	Blue	藍
3	Orange	橘	3	Orange	橘
2	Brown	棕	2	Brown	棕
1	Black	黑	1	Black	黑

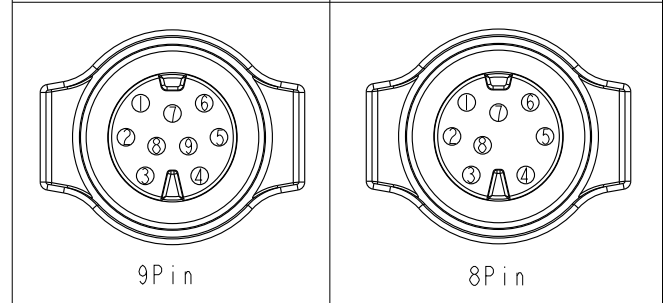

△C

Pin Out	4	--	4	Blue	藍	4	Blue	藍	6	Green	綠	6	Grey	灰	9	--	
	3	White	3	White	白	3	White	白	5	--		5	Yellow	黃	8	--	
	2	--	2	--		2	Brown	棕	4	Black	黑	4	Green	綠	7	Red	紅
	1	Black	1	Black	黑	1	Black	黑	3	Blue	藍	3	White	白	6	Green	綠
									2	White	白	2	Blue	藍	5	Yellow	黃
									1	Brown	棕	1	Brown	棕	4	Blue	藍
Pin Assignments Front View																	
	2Pin		3Pin		4Pin		5Pin		6Pin		7Pin		8Pin		9Pin		

UNIT:mm TOLERANCE ±0.5	TITLE MIDDLE CABLE RBL F CONN M PIN		Amphenol LTW 安費諾亮泰企業股份有限公司		ITEM NO	DRAWN BY Joyy	DATE 2015-11-10
	SCALE 3:4	SIZE A4			SHEET 2 OF 2	DWG NO CD-XXAFMM-RL7AXX	CHECKED BY Lu Di
	REV. C	WC-REV. A.3	◎: Inspection item		CUSTOMER ALTW	APPROVED BY Jerry	DATE 2015-11-10

## X-ON Electronics

Largest Supplier of Electrical and Electronic Components

*Click to view similar products for [Sensor Cables / Actuator Cables](#) category:*

*Click to view products by [Amphenol](#) manufacturer:*

Other Similar products are found below :

[60963](#) [60964](#) [M83513/19-F01CP](#) [703000D02F2002](#) [703001D02F0602](#) [703001D02F300](#) [704000D02F120](#) [773032K02F030](#) [802027107404-1](#)  
[802027213811-1](#) [804001A09M150](#) [805001A09M0502](#) [84914-0235](#) [84914-0237](#) [885030A09M020](#) [8R4J30E03C3003](#) [1200651332](#)  
[1200651713](#) [1200660844](#) [1200660845](#) [1200661173](#) [1200680071](#) [1200720053](#) [1200720081](#) [1200720099](#) [1200720217](#) [1200800231](#)  
[1200860125](#) [1200870123](#) [1200980102](#) [1200650267](#) [1200650298](#) [1200660183](#) [1200660782](#) [1200660849](#) [1200661295](#) [1200661297](#)  
[1200661342](#) [1200661343](#) [1200670080](#) [1200670220](#) [1200680331](#) [1200720252](#) [1200730184](#) [1200860344](#) [1200870359](#) [1200870643](#)  
[1200980008](#) [1200980031](#) [1210502211](#)