

THIS DOCUMENT IS SUBJECT TO CHANGE WITHOUT NOTICE. IT IS CONFIDENTIAL AND A PROPERTY OF AMPHENOL LTW. DISCLOSURE TO THIRD PARTY HAS TO BE AUTHORIZED BY AMPHENOL LTW.

REV.	ECN NO.	DATE	SIGN	DESCRIPTION
B	LE31570316~17	2015/07/19	Lu Di	Change To Common drawing
C	LEN15B0386~390	2015/11/10	Joyy	Add 7-8 And 9 Pin To The Common Drawing

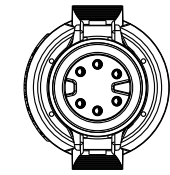
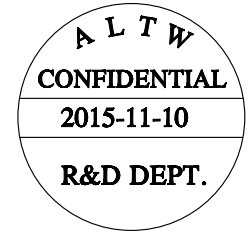
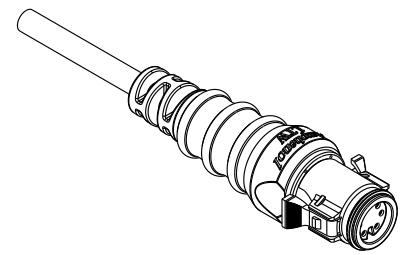
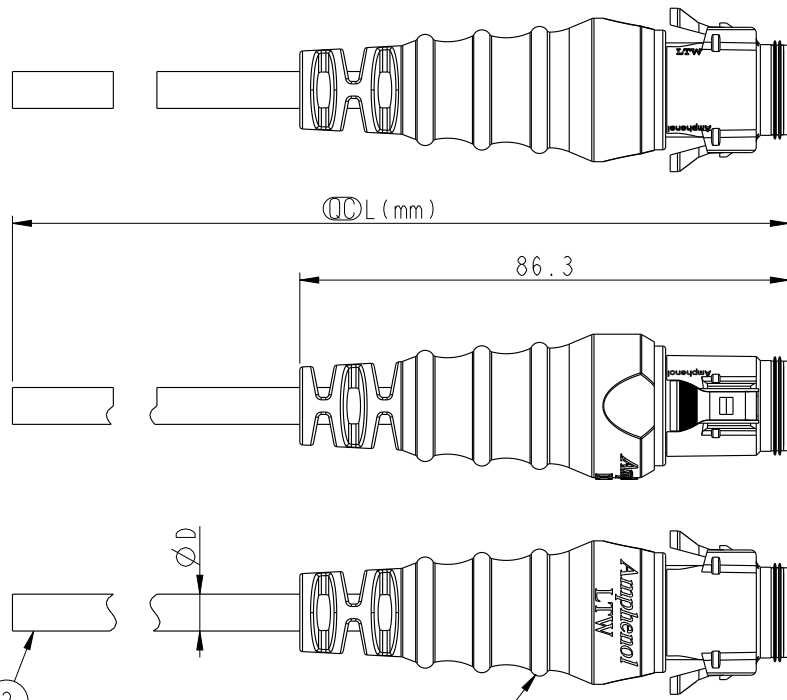

Conn

CD-XXAMFM-RL7000 (1)
Color:Black

- Note:
- * (1) Important Dimension To Check.
 - * Waterproof Rate: IP67
 - * Housing: M-PPE, Black.
 - * Female Pin: Copper Alloy, Gold Plated.
 - * Gasket: Silicone, Gray.
 - * Cable: UL2464 20#, PVC Jacket ,UV Resistant, Black.
 - * Cable Length Tolerance: 01M:±40mm
02M~05M:±60mm
06M~10M:±100mm
11M~30M:±200mm
31M~99M:±500mm
 - * Prohibiting the use of place in oils



CD-02AMFM-RL7AXX	
CD-03AMFM-RL7AXX	∅ 5.5
CD-04AMFM-RL7AXX	
CD-05AMFM-RL7AXX	∅ 6.0
CD-06AMFM-RL7AXX	∅ 6.5
CD-07AMFM-RL7AXX	
CD-08AMFM-RL7AXX	∅ 6.8
CD-09AMFM-RL7AXX	∅ 7.4
Part No.	Cable OD

UNIT:mm		
TOLERANCE	±0.5	

TITLE MIDDLE CABLE RBL M CONN F PIN			
SCALE 3:4	SIZE A4	SHEET 1 OF 2	
REV. C	WC-REV. A.3	(1) Inspection item	

Amphenol LTW
安費諾亮泰企業股份有限公司

ITEM NO	DRAWN BY Joyy	DATE 2015-11-10
DWG NO CD-XXAMFM-RL7AXX	CHECKED BY Lu Di	DATE 2015-11-10
CUSTOMER ALTW	APPROVED BY Jerry	DATE 2015-11-10

THIS DOCUMENT IS SUBJECT TO CHANGE WITHOUT NOTICE. IT IS CONFIDENTIAL AND A PROPERTY OF Amphenol LTW. DISCLOSURE TO THIRD PARTY HAS TO BE AUTHORIZED BY Amphenol LTW.

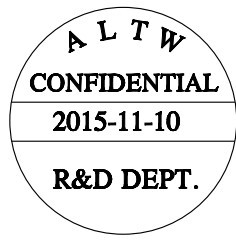

CD-XXAMFM-RL7A XX

Middle Size Current Rating 5A
 XX:No. Of Pin (Pin 數)
 A:Cable With S/R (線端帶網尾)
 M:Male Connector (公座)
 F:Female Pin (母Pin)
 M:Molding Type (射出成型)

XX:01~99Meter
 01:01Meter
 02:02Meter
 :
 :
 99:99Meter

A:UL 2464 Cable
 7:IP67 (防水等級 67)
 L: Straight (180°)
 R: Snap In With Latch (彈臂卡合式)

9	White	白	9	--	
8	Purple	紫	8	Purple	紫
7	Red	紅	7	Red	紅
6	Green	綠	6	Green	綠
5	Yellow	黃	5	Yellow	黃
4	Blue	藍	4	Blue	藍
3	Orange	橘	3	Orange	橘
2	Brown	棕	2	Brown	棕
1	Black	黑	1	Black	黑

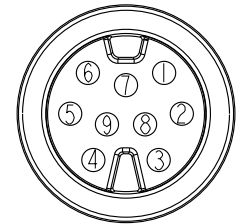

9Pin

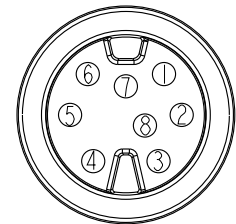

8Pin

Pin Out	4	--	4	Blue	藍	4	Blue	藍	6	Green	綠	6	Grey	灰	9	--	
	3	White	3	White	白	3	White	白	5	--		5	Yellow	黃	8	--	
	2	--	2	--		2	Brown	棕	4	Black	黑	4	Green	綠	7	Red	紅
	1	Black	1	Black	黑	1	Black	黑	3	Blue	藍	3	White	白	6	Green	綠
									2	White	白	2	Blue	藍	5	Yellow	黃
									1	Brown	棕	1	Brown	棕	4	Blue	藍
															3	Orange	橘
															2	Brown	棕
															1	Black	黑
Pin Assignments Front View																	
	2Pin		3Pin		4Pin		5Pin		6Pin		7Pin		8Pin		9Pin		

UNIT:mm TOLERANCE ±0.5	TITLE MIDDLE CABLE RBL M CONN F PIN		Amphenol LTW 安費諾亮泰企業股份有限公司		ITEM NO	DRAWN BY Joyy	DATE 2015-11-10
	SCALE 3:4	SIZE A4			SHEET 2 OF 2	DWG NO CD-XXAMFM-RL7AXX	CHECKED BY Lu Di
	REV. C	WC-REV. A.3	QC: Inspection item	CUSTOMER ALTW	APPROVED BY Jerry	DATE 2015-11-10	

X-ON Electronics

Largest Supplier of Electrical and Electronic Components

Click to view similar products for [Sensor Cables / Actuator Cables](#) category:

Click to view products by [Amphenol](#) manufacturer:

Other Similar products are found below :

[60963](#) [60964](#) [M83513/19-F01CP](#) [703000D02F2002](#) [703001D02F0602](#) [703001D02F300](#) [704000D02F120](#) [773032K02F030](#) [802027107404-1](#)
[802027213811-1](#) [804001A09M150](#) [805001A09M0502](#) [84914-0235](#) [84914-0237](#) [885030A09M020](#) [8R4J30E03C3003](#) [1200651332](#)
[1200651713](#) [1200660844](#) [1200660845](#) [1200661173](#) [1200680071](#) [1200720053](#) [1200720081](#) [1200720099](#) [1200720217](#) [1200800231](#)
[1200860125](#) [1200870123](#) [1200980102](#) [1200650267](#) [1200650298](#) [1200660183](#) [1200660782](#) [1200660849](#) [1200661295](#) [1200661297](#)
[1200661342](#) [1200661343](#) [1200670080](#) [1200670220](#) [1200680331](#) [1200720252](#) [1200730184](#) [1200860344](#) [1200870359](#) [1200870643](#)
[1200980008](#) [1200980031](#) [1210502211](#)