

# T LMR®

FLEXIBLE COMMUNICATIONS COAX

19th Edition

**NEW in this catalog!**

**Low PIM Jumper Cables**  
**SPP™ Plenum Rated**  
**SPF™ Fire Rated**  
**SPO™ Outdoor**  
**TFT™ Flexible**

**Times-Protect®**  
**Data Line Protectors**  
**Over Voltage Protection**

**IPB & WSB Weather Seal Boots**



### MISSION

TIMES MICROWAVE SYSTEMS designs and manufactures high performance RF transmission line for the telecommunications industry. These products consist of flexible coaxial cable, connectors, accessories and cable assemblies. We are committed to understanding the needs and requirements of our customers and providing highly engineered, cost effective products. TIMES MICROWAVE SYSTEMS is dedicated to *total* customer satisfaction and superior results for our shareholders in all we do.

**TIMES MICROWAVE SYSTEMS**  
An Amphenol Company

358 Hall Ave., Wallingford, CT, 06492-5039 U.S.A.  
Phone: 203-949-8400 Fax: 203-949-8423  
800-TMS-COAX • [www.timesmicrowave.com](http://www.timesmicrowave.com)

© 2016, Times Microwave Systems, Wallingford, CT 06492

WC-19  
08/16

**World Class Products for Wireless Applications**

## The History of TMS



Times Microwave Systems (TMS) was founded in 1948 as the Times Wire and Cable Company. TMS is an engineering oriented organization specializing in the design and manufacture of high performance flexible and semi-rigid coaxial cable, connectors, and cable assemblies for RF transmission from HF through Microwave frequencies. TMS is committed to

continuous improvement with respect to ISO-9001 Quality Standards and ISO-14001 Environmental Management Systems.



The expertise that provided cable solutions for the demanding requirements of airborne electronic warfare systems and led the way in the development of low smoke cables for shipboard applications is now yielding

high performance cables to meet the needs of the wireless communications market. The innovative product line provides a better alternative to corrugated copper cables for antenna feeders and system interconnects. Compared to corrugated copper cables, LMR cables offer better flexibility, resistance to linking, comparable attenuation, and easier connector attachment at a lower cost.

The work performed at TMS in the 60's, 70's, and 80's forms the basis for today's high performance coaxial cables. TMS pioneered the development of closed cell low loss polyethylene foam dielectric and low loss taped PTFE dielectric coaxial cables. Through a thorough understanding of transmission line theory and manufacturing processes, TMS was the first to produce cables with reduced periodicity and impedance matched interfaces, resulting in the first transmission lines with low

VSWR over broadband frequency ranges up to 40 GHz. The development of connector design and manufacturing expertise allowed TMS to take full performance responsibility for the entire cable assembly, which was unprecedented at the time.

TMS has been instrumental in the development of military specifications, including MIL-C-17 for coaxial cables. Times is the leading source of MIL-C-17 qualified products, holding far more QPL's (Qualified Product Listings) than any other manufacturer in the world. Times also helped the US Navy write the MIL-T-81490 Transmission Line Specification, and is qualified to supply microwave transmission lines that meet MIL-T-81490 and MIL-C-87104 (US Air Force) requirements. These are the specifications that define harsh military airborne environments that Electronic Warfare transmission lines must perform in, year after year.

TMS applies its expertise to customer requirements through a staff of Field Application Engineers. Unlike other cable manufacturers with limited product lines, who try to fit customer applications to their existing products, the philosophy of TMS is to select or design the right product for the application. This results in an optimal and cost effective solution.



TMS is the leader in the design, qualification, manufacture, and on-time delivery of high performance cable and cable assembly products to the commercial wireless and military marketplace. In 2003, TMS was selected by Lockheed Martin Aeronautics to supply the Broadband Airborne Cable Assemblies on the F-35 Joint Strike Fighter (JSF). TMS was chosen to supply this solution since its high performance cable assemblies are able to handle high-speed data in extreme avionics environments including wide variations in temperature and pressure.



LMR <sup>®</sup> Discussion .....	4
LMR <sup>®</sup> Flexible Low Loss Cable .....	10
LMR <sup>®</sup> - LW Lightweight Low Loss Cable .....	48
LMR <sup>®</sup> - UF Ultra Flexible Low Loss Cable.....	58
LMR <sup>®</sup> - LLPL Low Loss Plenum Cable .....	76
LMR <sup>®</sup> - 75 Ohm Flexible Low Loss Cable .....	104
TCOM <sup>®</sup> Flexible Low Loss Passive Intermod Cable .....	118
Installation Tools & Hardware Accessories .....	140
Engineered Products	
Engineered Products Overview & Training Program ...	153
T-RAD <sup>®</sup> 50 Ohm Leaky Feeder Coaxial Cable .....	176
SilverLine <sup>®</sup> Test Cables .....	182
IntraFlex <sup>™</sup> System Interconnect Assemblies .....	212
LMR <sup>®</sup> -SW Smooth Wall Aluminum, Low PIM Cable .....	216
SPP <sup>™</sup> , SPO <sup>™</sup> , SPF <sup>™</sup> Low PIM Coaxial Cables .....	218
TFT <sup>™</sup> & TFT-LF <sup>™</sup> Low PIM Coaxial Cables .....	230
Bundled Cable .....	238
Times-Protect <sup>®</sup> Lightning Protection.....	242
Tech Notes .....	290
Communications Coax Selection Guide .....	310

## LMR<sup>®</sup> discussion



- Broadband
- Wireless Machine-to-Machine (Wireless M2M)
- Military/Defense

### Where can LMR<sup>®</sup> cables be used?

Times LMR cables can be used virtually anywhere high performance coaxial cables are used, including:

- Internal component and equipment wiring
- Inter/intra cabinet jumpers
- Base station and antenna jumpers
- Tower and pole feeder runs
- In-building runs, including riser runs and air-handling plenums
- Rooftop installations

### What sizes of LMR<sup>®</sup> cable are available?

A full range of LMR cables are available from LMR-100 (0.100") all the way up to LMR-1700-DB (1 1/4"). Because LMR cables are so flexible, it's possible to eliminate jumpers entirely in many feeder cable applications. The elimination of jumper cables provides reduced cost, better reliability and lower cost- or may even allow the use of a smaller size feeder cable, while achieving the same loss as for a larger corrugated feeder.

### What is LMR<sup>®</sup> cable?

Times LMR cables are high performance broadband, flexible, low loss 50 Ohm coaxial communication cables designed for use in wireless applications such as:

- Private land mobile/2-way land mobile
- WiFi/WiMax
- Cellular
- Paging
- Satellite
- Cellular
- Paging
- GPS
- RFID
- In-Building Communications
- Oil & Gas
- Utilities
- Positive Train Control (PTC)
- Distributed Antenna Systems (DAS)
- Public Safety
- Wireless Internet (WISP)
- SCADA/Telemetry

### What are the advantages of LMR<sup>®</sup>?

Times LMR cables have RF performance comparable to traditional corrugated copper cables, but unlike corrugated cables they are highly flexible, non-kinking, and offer unsurpassed ease and speed of connector installation. Compared to RG type braided cables, LMR cables offer far lower loss and better RF shielding. These features make LMR cables the best choice for *any* wireless application.

### What makes LMR<sup>®</sup> cable different than corrugated cables?

Design features of Times LMR cable include:

#### 1) Polyethylene Foam Dielectric

- Closed cell
- Dry nitrogen gas injected- no moisture to degrade performance
- High velocity
- Low loss

## 2) High Performance Flexible Shielding System

- Multi-laminar aluminum composite tape bonded to the dielectric
- Provides >90dB isolation shielding (180dB cross talk)
- Bonded construction ensures 100% effective shielding
- Acts as a second moisture barrier
- Outer Braid of tinned copper:
  - Provides positive means for grounding and connector attachment

## 3) Polyethylene Outer Jacket

- Heavy duty UV, sunlight and weather resistant, 20 to 40 year life

## How does LMR® cable compare to RG type braided cable or 9913?

LMR cables have lower loss and far better shielding than comparably sized braided cables. Polyethylene jacket, closed cell foam poly dielectric and bonded tape conductor all contribute to the superior weather resistance of LMR cables compared to braided cables and 9913.

## Is there only one type of LMR® cable, or are there options?

Included in this catalog are the many different types of LMR cables which are available, so you can always be certain that there is an LMR cable just right for your particular application. Besides standard LMR cable, Times offers:

**LMR-FR:** Fire retardant cable for installation in building vertical risers or where fire retardancy is critical, both UL and CSA listed (CMR/CATVR).

**LMR-LLPL:** Low loss plenum rated cables for use in virtually any in-building application, including air handling plenums and spaces where maximum fire retardancy and low smoke generation are required. LMR-LLPL cables are the most rugged and easiest to install plenum rated cables available, especially for difficult installs in older buildings. Cables are both UL and CSA listed (CMP/CATVP).

**LMR-DB:** Watertight cables with an inert flooding compound injected in the braid to completely eliminate the possibility of any water migration- *with a 10 year*

*warranty!* The DB feature is optional on sizes 600 and smaller, and standard on sizes 900 and larger.

**LMR Ultraflex:** Stranded center conductor and thermoplastic rubber jacket for maximum flexibility.

**LMR-MA:** Unbonded tape shield for ease of removal for special applications.

**LMR-PVC:** Polyvinylchloride outer jacket for enhanced flexibility.

**LMR-lite:** Lightweight version of the standard LMR cable. Aluminum braid is used instead of tinned copper braid to offer a lighter weight cable.

**FBT:** Similar to LMR-LLPL, but with a fluoropolymer (FEP) outer jacket for high temperature performance up to 150°C (302°F).

**T-COM:** The ultimate in low loss, high performance coax with a triple shielding system pioneered by Times to achieve enhanced shielding and low passive intermod (-155dB).

**LMR-75:** These are 75 Ohm versions of the standard LMR cable for unsurpassed performance in broadband video and specialized RF applications.

**T-RAD:** 50 Ohm leaky feeder cable for RF coverage up to 2.5GHz. For use in buildings, mines, tunnels or any enclosed area. Flexible, non-kinking low cost design.



## LMR<sup>®</sup> discussion



### What about connectors and installation tools?

Times offers a complete line of connectors for all its cables. A wide variety of connector interfaces is offered for almost every application:

- N
- BNC
- TNC
- UHF
- Reverse polarity
- MUHF
- 716DIN
- SMA
- QDS (quick disconnect)
- F
- LC
- HN
- QMA

Special connectors are available, and Times is always adding new ones. Times also offers a complete line of cable prep and connector installation tools, so you never will be frustrated by not having the right tools- Times is your one-stop source.

### Do all Times connectors require soldering?

An extensive line of solder-pin type connectors is offered. However, Times has become the recognized industry leader in developing simplified connectors especially suited for field applications offering more nonsolder type connectors than any other cable manufacturers. The Times well-known line of Advantage™ -X series EZ nonsolder connectors which also do not require braid trimming has become renowned in the industry. With center pin contacts made from silver or gold plated beryllium-copper,

EZ connectors are the preferred choice for quick and reliable field installations.

### How can I get cable and tower installation accessories that work with LMR<sup>®</sup> cable?

Easy- Times furnishes a complete line of site installation hardware and accessories- everything you need to get you from the antenna to the equipment:

- **Ground kits:** Perfectly sized to each LMR cable, with never a chance of the ground strap being too tight (crushed cable), or too loose (poor grounding).
- **Hangers:** Snap-in, butterfly
- **Hoisting grips**
- **Weatherproofing kits:** Tape and cold shrink
- **Tie wraps**
- **Mounting hardware**
- **Entry ports and hardware**

### Does anyone else make a cable like LMR<sup>®</sup>?

Some have tried, but no one can match Times LMR when it comes to what's important to the customer. Some don't even offer anything but cable, while Times offers:

- The most complete line of cable, connectors (including *EZ*), tools and accessories
- The biggest range of sizes
- The most cable type options
- The most extensive distribution network
- Unsurpassed technical support
- The assurance that comes from knowing you are dealing with the industry leader, and
- ***The only company with its phone number printed on every foot of cable we make.*** You never have to guess who to call if you have a question or need help solving a problem, because everything is supplied by Times.

### What about price?

In most cases Times LMR cables and connectors will save you money compared to corrugated cable. By combining the lower purchase cost with the ease and speed of installation, excellent savings are achieved. LMR cables also offer significant performance advantages compared to RG type cables at comparable prices.



## LMR®



- **LMR® - PVC** is designed for low loss general-purpose applications and is somewhat more flexible than the standard polyethylene jacketed LMR.
- **LMR® - PVC-W** is a white-jacketed version of LMR-PVC for marine and other applications where color compatibility is desired.
- **LMR® - MA** is a flexible cable designed specifically for mobile antenna applications. It has a PVC jacket and un-bonded aluminum tape to facilitate end stripping with automated equipment.

- **LMR® standard** is a UV Resistant Polyethylene jacketed cable designed for 20-year service outdoor use. The bending and handling characteristics are significantly better than air-dielectric and corrugated hard-line cables.
- **LMR® - DB** is identical to standard LMR plus has the advantage of being watertight. The addition of waterproofing compound in and around the foil/braid insures continuous reliable service should the jacket be inadvertently damaged during installation or in the future.
- **LMR® - FR** is a non-halogen (non-toxic), low smoke, fire retardant cable designed for in-building runs that can be routed anywhere except air handling plenums. LMR-FR is UL/NEC & CSA rated 'CMR' and 'FT4' respectively, meets FAA FAR25 requirements and is MSHA-P for mining applications.
- **LMR® - FR-PVC** is a general-purpose indoor cable and has a UL/NEC & CSA rating of 'CMR' and 'FT4' respectively. It is less expensive than LMR-FR, however it emits toxic fumes (HCL) and greater smoke density when burned.





- **Flexibility** and bendability are hallmarks of the LMR cable design. The flexible outer conductor enables the tightest bend radius available for any cable of similar size and performance.
- **Low Loss** is another hallmark feature of LMR. Size for size LMR has the lowest loss of any flexible cable and comparable loss to semirigid hard-line cables.
- **RF Shielding** is 50 dB greater than typical single shielded coax (40 dB). The multi-ply bonded foil outer conductor is rated conservatively at > 90 dB (i.e. >180 dB between two adjacent cables).
- **Weatherability:** LMR cables designed for outdoor exposure incorporate the best materials for UV resistance and have life expectancy in excess of 20 years.

- **Connectors:** A wide variety of connectors are available for LMR cables, including all common interface types, reverse polarity, and a choice of solder or non-solder center pins. Most LMR connectors employ crimp outer attachment using standard hex crimp sizes.
- **Cable Assemblies:** All LMR cable types are available as pre-terminated cable assemblies. Refer to the section on FlexTech for further details.



LMR Bundled Cable



# LMR<sup>®</sup> 100A Flexible Low Loss Communications Coax

Ideal for...

- Drop-in Replacement for RG-316/RG-174 (uses standard connectors)
- Jumper Assemblies in Wireless Communications Systems
- Short Antenna Feeder runs
- Any application (e.g. WLL, GPS, LMR, WLAN, WISP, WiMax, SCADA, Mobile Antennas) requiring an easily routed, low loss RF cable



Part Number	Part Description			Stock Code
	Application	Jacket	Color	
LMR-100A-FR	Indoor/Outdoor-FR	FRPE	Black	54037
LMR-100A-PVC	Indoor/Outdoor	PVC	Black	54119
LMR-100A-PVC-W	Indoor/Outdoor	PVC	White	54200
LMR-100A-UF	Indoor	TPE	Black	54274
LMR-100-PUR	Indoor	PUR	Black	54363

Construction Specifications			
Description	Material	In.	(mm)
Inner Conductor	Solid BCCS	0.018	(0.46)
Dielectric	Solid PE	0.060	(1.52)
Outer Conductor	Aluminum Tape	0.065	(1.65)
Overall Braid	Tinned Copper	0.083	(2.11)
Jacket	See Table	0.110	(2.79)

PVC = Poly Vinyl Chloride

Attenuation vs. Frequency (typical)

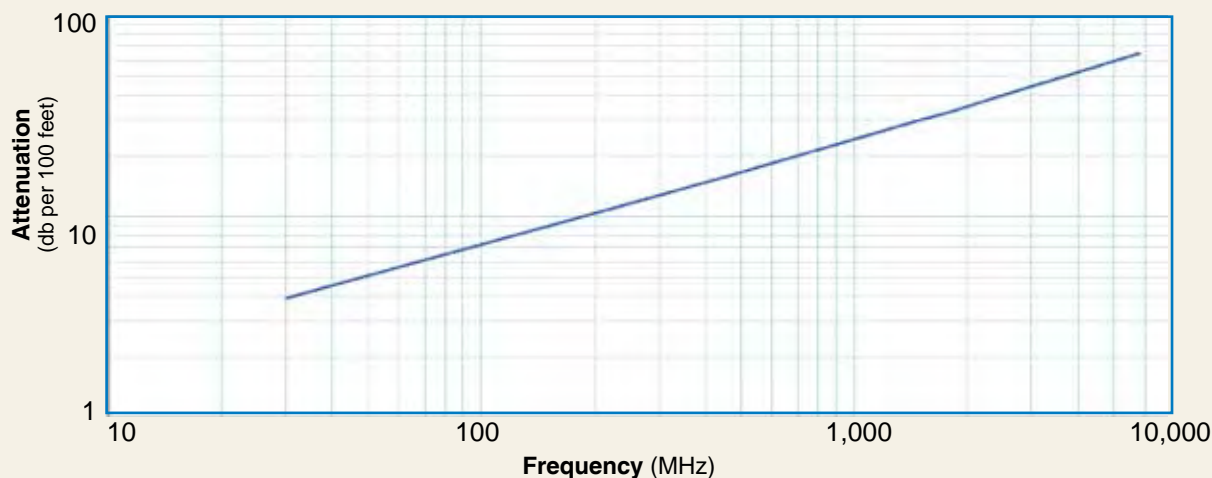

Frequency (MHz)	30	50	150	220	450	900	1500	1800	2000	2500	5800	80000
Attenuation dB/100 ft	3.9	5.1	8.9	10.9	15.8	22.8	30.1	33.2	35.2	39.8	64.1	77.3
Attenuation dB/100 m	12.9	16.7	29.4	35.8	51.9	74.9	98.7	109.0	115.5	130.6	210.3	253.8
Avg. Power kW	0.230	0.180	0.100	0.083	0.057	0.039	0.029	0.027	0.025	0.022	0.013	0.01

Calculate Attenuation = (0.709140) \* √FMHz + (0.001740) \* FMHz (interactive calculator available at <http://www.timesmicrowave/telecom>)  
 Attenuation: VSWR=1.0 ; Ambient = +25°C (77°F) Power: VSWR=1.0; Ambient = +40°C; Inner Conductor = 100°C (212°F);  
 Sea Level; dry air; atmospheric pressure; no solar loading

Environmental Specifications		
Performance Property	°F	°C
Installation Temperature Range	-40/+185	-40/+85
Storage Temperature Range	-94/+185	-70/+85
Operating Temperature Range	-40/+185	-40/+85

Mechanical Specifications			
Performance Property	Units	US	(metric)
Bend Radius: installation	in. (mm)	0.25	(6.4)
Bend Radius: repeated	in. (mm)	1	(25.4)
Bending Moment	ft-lb (N-m)	0.1	(0.014)
Weight	lb/ft (kg/m)	0.0092	(.014)
Tensile Strength	lb (kg)	15	(6.8)
Flat Plate Crush	lb/in. (kg/mm)	10	(0.18)

Electrical Specifications			
Performance Property	Units	US	(metric)
Velocity of Propagation	%	66	
Dielectric Constant	NA	2.30	
Time Delay	nS/ft (nS/m)	1.54	(5.05)
Impedance	ohms	50	
Capacitance	pF/ft (pF/m)	30.8	(101.1)
Inductance	uH/ft (uH/m)	0.077	(0.25)
Shielding Effectiveness	dB	>90	
DC Resistance			
Inner Conductor	ohms/1000ft (/km)	81.0	(266)
Outer Conductor	ohms/1000ft (/km)	9.5	(31.2)
Voltage Withstand	Volts DC	500	
Jacket Spark	Volts RMS	2000	
Peak Power	kW	0.6	

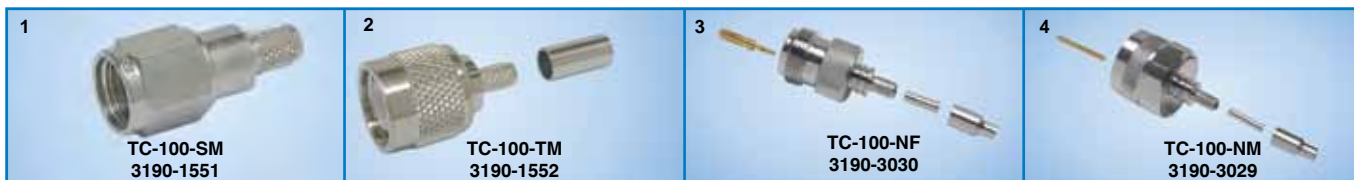

Connectors												
Interface	Description	Part Number	Stock Code	VSWR ** Freq.	Coupling (GHz)	Nut	Inner Contact Attach	Outer Contact Attach	Finish* Body /Pin	Length in (mm)	Width in (mm)lb	Weight (g)
1. SMA Male	Straight Plug	TC-100-SM	3190-1551	<1.25:1	(3)	Hex	Solder	Crimp	SS/G	1.0 (25.4)	0.32 (8.1)	0.015 (6.8)
2. TNC Male	Straight Plug	TC-100-TM	3190-1552	<1.25:1	(3)	Knurl	Solder	Crimp	S/G	1.4 (35.6)	0.59 (15.0)	0.045 (20.4)
3. N Female	Straight Jack	TC-100-NF	3190-3030	<1.25:1	(3)	N/A	Solder	Crimp	A/G	1.3 (32.4)	0.62 (15.8)	0.055 (25.0)
4. N Male	Straight Plug	TC-100-NM	3190-3029	<1.25:1	(3)	Hex	Solder	Crimp	A/G	1.1 (28.2)	0.9 (22.6)	0.066 (30.0)

\* Finish metals: N=Nickel, S=Silver, G=Gold, SS=Stainless Steel, A=Alloy \*\*VSWR spec based on 3 foot cable with a connector pair

## Install Tools

Type	Part Number	Stock Code	Description
Crimp Tool	CT-240/200/195/100	3190-667	Crimp tool for LMR-100, 195, 200 and 240 connectors
Cutting Tool	CCT-02	3192-165	Cable end flush cut tool
Replacement Blade	RB-02	3192-166	Replacement blade for cutting tool



# LMR<sup>®</sup>-195 Flexible Low Loss Communications Coax

Ideal for...

- Jumper Assemblies in Wireless Communications Systems
- Short Antenna Feeder runs
- Any application (e.g. WLL, GPS, LMR, WLAN, WiMax, SCADA, Mobile Antennas) requiring an easily routed, low loss RF cable
- Drop-in replacement for RG-58 and RG-142



Part Description					Stock
Part Number	Application	Jacket	Color	Code	
LMR-195	Outdoor	PE	Black	54110	
LMR-195-DB	Outdoor/Watertight	PE	Black	54113	
LMR-195-FR	Indoor/Outdoor Riser CMR	FRPE	Black	54111	
LMR-195-FR-W	Indoor/Outdoor Riser CMR	FRPE	White	54158	
LMR-195-FR-PVC	Indoor/Outdoor Riser CMR	FRPVC	Black	54105	
LMR-195-MA	Mobile Antennas	PVC	Black	54210	
LMR-195-PVC	General Purpose	PVC	Black	54215	
LMR-195-PVC-W	General Purpose	PVC	White	54199	

Construction Specifications			
Description	Material	In.	(mm)
Inner Conductor	Solid BC	0.037	(0.94)
Dielectric	Foam PE	0.110	(2.79)
Outer Conductor	Aluminum Tape	0.116	(2.95)
Overall Braid	Tinned Copper	0.139	(3.53)
Jacket	(see table)	0.195	(4.95)

Environmental Specifications		
Performance Property	°F	°C
Installation Temperature Range	-40/+185	-40/+85
Storage Temperature Range	-94/+185	-70/+85
Operating Temperature Range	-40/+185	-40/+85

Electrical Specifications			
Performance Property	Units	US	(metric)
Velocity of Propagation	%	80	
Dielectric Constant	NA	1.56	
Time Delay	nS/ft (nS/m)	1.27	(4.17)
Impedance	ohms	50	
Capacitance	pF/ft (pF/m)	25.4	(83.3)
Inductance	uH/ft (uH/m)	0.064	(0.21)
Shielding Effectiveness	dB	>90	
DC Resistance			
Inner Conductor	ohms/1000ft (/km)	7.6	(24.9)
Outer Conductor	ohms/1000ft (/km)	4.9	(16.1)
Voltage Withstand	Volts DC	1000	
Jacket Spark	Volts RMS	3000	
Peak Power	kW	2.5	

Mechanical Specifications			
Performance Property	Units	US	(metric)
Bend Radius: installation	in. (mm)	0.5	(12.7)
Bend Radius: repeated	in. (mm)	2.0	(50.8)
Bending Moment	ft-lb (N-m)	0.2	(0.27)
Weight	lb/ft (kg/m)	0.021	(0.03)
Tensile Strength	lb (kg)	40	(18.2)
Flat Plate Crush	lb/in. (kg/mm)	15	(0.27)

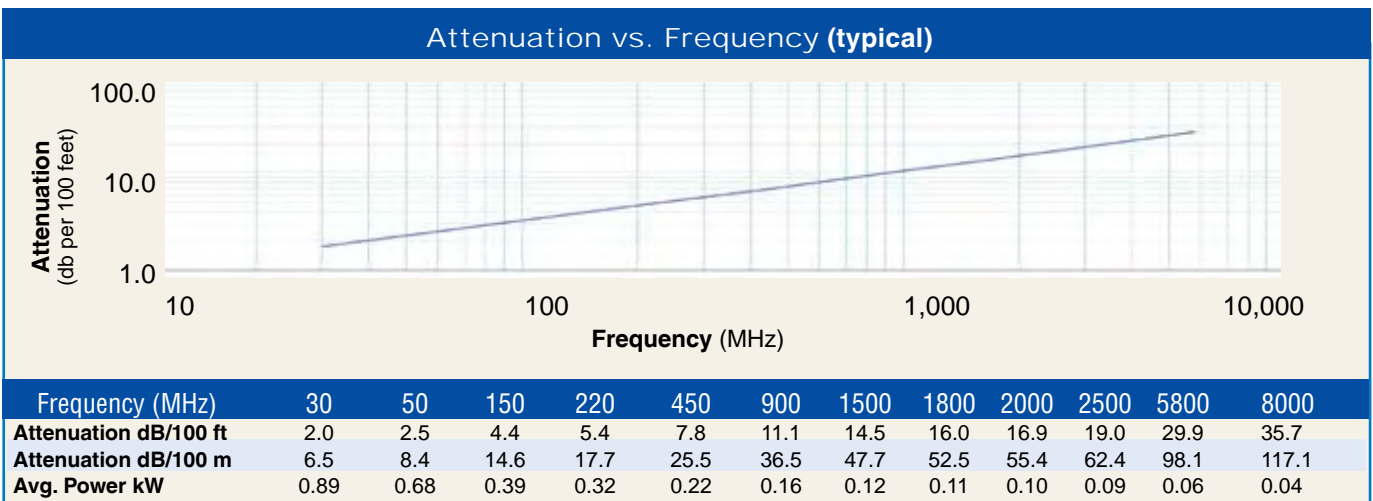

## Connectors

Interface	Description	Part Number	Stock Code	VSWR** Freq. (GHz)	Coupling Nut	Inner Contact Attach	Outer Contact Attach	Finish* Body /Pin	Length in (mm)	Width in (mm)	Weight lb (g)
1. N Male	Straight Plug	TC-195-NMH-X	3190-2880	<1.25:1 (2.5)	Knurl	Solder	Crimp	S/G	1.5 (38.1)	0.75 (19.1)	0.073 (33.1)
2. N Male	Right Angle	TC-195-NMH-RA-D	3190-2425	<1.35:1 (6)	Hex/Knurl	Solder	Crimp	A/G	1.3 (32.1)	1.19 (30.1)	0.083 (37.5)
3. SMA Male	Straight Plug	TC-195-SM-SS-X	3190-2878	<1.25:1 (2.5)	Hex	Solder	Crimp	SS/G	1.0 (25.4)	0.32 (8.1)	0.015 (6.8)
4. TNC Male	Straight Plug	TC-195-TM-X	3190-2879	<1.25:1 (2.5)	Knurl	Solder	Crimp	S/G	1.4 (35.6)	0.59 (15.0)	0.045 (20.4)
5. SMA Male	Straight Plug	EZ-195-SM-X	3190-6140	<1.30:1 (6)	Hex	Spring Finger	Crimp	A/G	0.9 (22.0)	0.37 (9.4)	0.019 (8.6)
6. BNC Male	Straight Plug	EZ-195-BM-X	3190-6141	<1.30:1 (4)	Knurl	Spring Finger	Crimp	A/G	1.1 (28.4)	0.60 (14.5)	0.045 (20.4)
7. TNC Male	Reverse Polarity	EZ-195-TM-RP-X	3190-6142	<1.35:1 (6)	Hex	Spring Finger	Crimp	A/G	1.1 (28.3)	0.87 (22.0)	0.045 (20.4)

\* Finish metals: N=Nickel, S=Silver, G=Gold, SS=Stainless Steel, A=Alballoy \*\*VSWR spec based on 3 foot cable with a connector pair



## Install Tools

Type	Part Number	Stock Code	Description
Crimp Tool	CT-240/200/195/100	3190-667	Crimp tool for LMR-100,195, 200 and 240 connectors
Cutting Tool	CCT-02	3192-165	Cable end flush cut tool
Combination Strip Tool	CST-195/200	3192-102	Prep tool for LMR-195/200
Deburr Tool	DBT-U	3192-001	Removes center conductor rough edges
Replacement Blade Kit	RB-CST	3192-086	Replacement blade kit for all CST cutting tools



Calculate Attenuation =  $(0.356859)\sqrt{\text{FMHz}} + (0.000470) \cdot \text{FMHz}$  (interactive calculator available at [http://www.timesmicrowave.com/cable\\_calculators](http://www.timesmicrowave.com/cable_calculators))  
**Attenuation:** VSWR=1.0; Ambient = +25°C (77°F) **Power:** VSWR=1.0; Ambient = +40°C; Inner Conductor = 100°C (212°F);  
 Sea Level; dry air; atmospheric pressure; no solar loading

# LMR<sup>®</sup>-200 Flexible Low Loss Communications Coax

## Ideal for...

- Jumper Assemblies in Wireless Communications Systems
- Short Antenna Feeder runs
- Any application (e.g. WLL, GPS, LMR, WLAN, WISP, WiMax, SCADA, Mobile Antennas) requiring an easily routed, low loss RF cable



Part Description				
Part Number	Application	Jacket	Color	Stock Code
LMR-200	Outdoor	PE	Black	54022
LMR-200-DB	Outdoor/Watertight	PE	Black	54089
LMR-200-FR	Indoor/Outdoor Riser CMR	FRPE	Black	54028
LMR-200-FR-PVC	Indoor/Outdoor Riser CMR	FRPVC	Black	54125
LMR-200-PVC	General Purpose	PVC	Black	54216
LMR-200-PVC-W	General Purpose	PVC	White	54201
LMR-200-MA	Mobile Antennas	PVC	Black	54045

Construction Specifications			
Description	Material	In.	(mm)
Inner Conductor	Solid BC	0.044	(1.12)
Dielectric	Foam PE	0.116	(2.95)
Outer Conductor	Aluminum Tape	0.121	(3.07)
Overall Braid	Tinned Copper	0.144	(3.66)
Jacket	(see table)	0.195	(4.95)

Environmental Specifications			
Performance Property	°F	°C	
Installation Temperature Range	-40/+185	-40/+85	
Storage Temperature Range	-94/+185	-70/+85	
Operating Temperature Range	-40/+185	-40/+85	

Electrical Specifications			
Performance Property	Units	US	(metric)
Velocity of Propagation	%	83	
Dielectric Constant	NA	1.45	
Time Delay	nS/ft (nS/m)	1.22	(4.02)
Impedance	ohms	50	
Capacitance	pF/ft (pF/m)	24.5	(80.3)
Inductance	uH/ft (uH/m)	0.061	(0.20)
Shielding Effectiveness	dB	>90	
DC Resistance			
Inner Conductor	ohms/1000ft (/km)	5.36	(17.6)
Outer Conductor	ohms/1000ft (/km)	4.9	(16.1)
Voltage Withstand	Volts DC	1000	
Jacket Spark	Volts RMS	3000	
Peak Power	kW	2.5	

Mechanical Specifications			
Performance Property	Units	US	(metric)
Bend Radius: installation	in. (mm)	0.5	(12.7)
Bend Radius: repeated	in. (mm)	2	(50.8)
Bending Moment	ft-lb (N-m)	0.2	(0.27)
Weight	lb/ft (kg/m)	0.022	(0.03)
Tensile Strength	lb (kg)	40	(48)
Flat Plate Crush	lb/in. (kg/mm)	15	(0.27)

Attenuation vs. Frequency (typical)

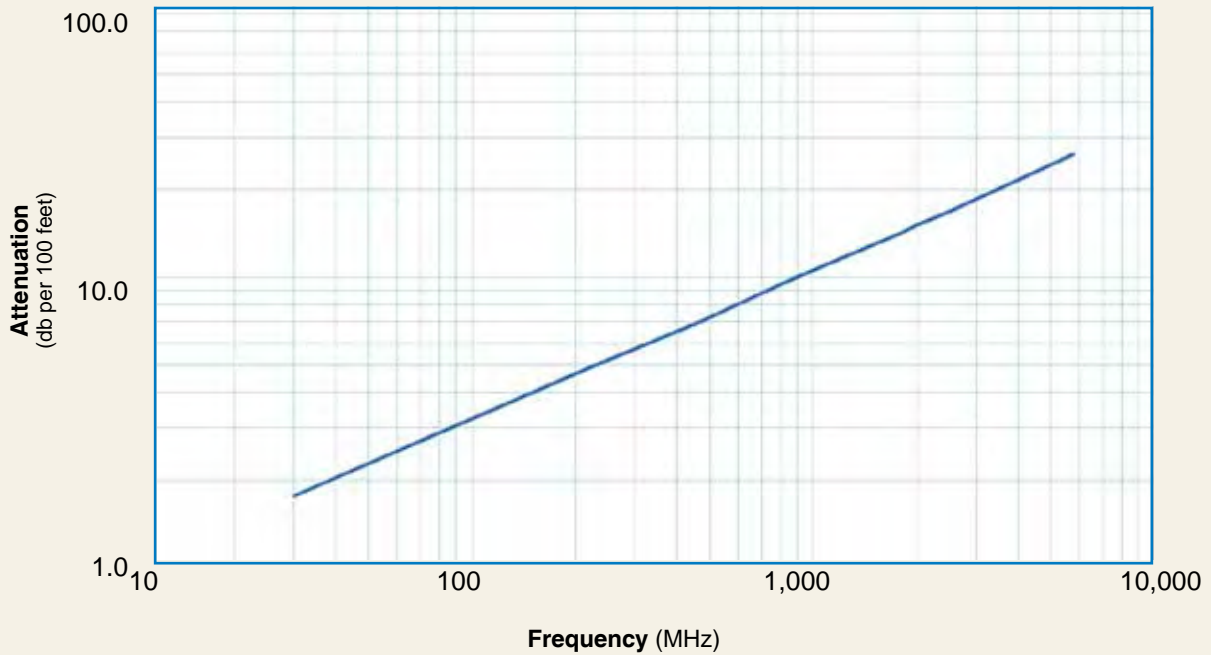

Frequency (MHz)	30	50	150	220	450	900	1500	1800	2000	2500	5800	8000
<b>Attenuation dB/100 ft</b>	1.8	2.3	4.0	4.8	7.0	9.9	12.9	14.2	15.0	16.9	26.4	31.3
<b>Attenuation dB/100 m</b>	5.8	7.5	13.1	15.9	22.8	32.6	42.4	46.6	49.3	55.4	86.5	102.8
<b>Avg. Power kW</b>	1.02	0.79	0.45	0.37	0.26	0.18	0.14	0.13	0.12	0.11	0.07	0.06

**Calculate Attenuation =**  
 $(0.320900) \cdot \sqrt{\text{FMHz}} + (0.000330) \cdot \text{FMHz}$  (interactive calculator available at [http://www.timesmicrowave.com/cable\\_calculators](http://www.timesmicrowave.com/cable_calculators))

**Attenuation:**  
 VSWR=1.0; Ambient = +25°C (77°F)

**Power:**  
 VSWR=1.0; Ambient = +40°C; Inner Conductor = 100°C (212°F); Sea Level; dry air; atmospheric pressure; no solar loading

# LMR<sup>®</sup>-200 Flexible Low Loss Communications Coax



Connectors		Part Number	Stock Code	VSWR**	Coupling	Inner Contact Attach	Outer Contact Attach	Finish* Body /Pin	Length in (mm)	Width in (mm)	Weight lb (g)
1. BNC Male	Straight Plug	TC-200-BM-X	3190-2883	<1.25:1 (2.5)	Knurl	Solder	Crimp	S/G	1.7 (43.2)	0.56 (14.2)	0.045 (20.4)
2. Mini-UHF	Straight Plug	TC-200-MUHF	3190-444	<1.25:1 (2.5)	Knurl	Solder	Crimp	NG	1.1 (27.9)	0.45 (11.4)	0.015 (6.8)
3. N Male	Straight Plug	EZ-200-NMH-X	3190-2886	<1.25:1 (8)	Hex/Knurl	Spring Finger	Crimp	A/G	1.5 (38.1)	0.75 (19.1)	0.073 (33.1)
4. N Male	Straight Plug	TC-200-NMH-X	3190-2882	<1.25:1 (6)	Hex	Solder	Crimp	A/G	1.5(38.1)	0.89 (22.6)	0.086 (39.0)
5. N Male	Reverse Polarity	TC-200-NM-RP	3190-959	<1.25:1 (2.5)	Knurl	Solder	Crimp	N/G	1.5 (38.1)	0.75 (19.1)	0.073 (33.1)
6. SMA Male	Straight Plug	TC-200-SM-SS-X	3190-2881	<1.25:1 (2.5)	Hex	Solder	Crimp	SS/G	1.0(38.1)	0.75 (19.1)	0.073 (33.1)
7. SMA Male	Reverse Polarity	TC-200-SM-RP	3190-327	<1.25:1 (2.5)	Hex	Solder	Crimp	SS/G	1.0 (25.4)	0.32 (8.1)	0.015 (6.8)
8. TNC Male	Straight Plug	EZ-200-TM-X	3190-2885	<1.25:1 (2.5)	Knurl	Spring Finger	Crimp	S/G	1.4 (35.6)	0.59 (15.0)	0.045 (20.4)
9. TNC Male	Straight Plug	TC-200-TMC	3190-240	<1.25:1 (2.5)	Knurl	Solder	Clamp	S/G	1.7 (43.2)	0.59 (15.0)	0.045 (20.4)
10. TNC Male	Reverse Polarity	EZ-200-TM-RP	3190-792	<1.25:1 (2.5)	Knurl	Spring Finger	Crimp	A/G	1.4 (35.6)	0.32 (8.1)	0.045 (20.4)
11. TNC Female	Straight Jack	TC-200-TF-X	3190-2884	<1.25:1 (2.5)	NA	Solder	Crimp	N/G	1.3 (33.0)	0.57 (14.5)	0.033 (15.0)
12. TNC Female	Reverse Polarity	EZ-200-TF-RP	3190-793	<1.25:1 (2.5)	NA	Spring Finger	Crimp	A/G	1.3 (33.0)	0.57 (14.5)	0.033 (15.0)
13. SMA Female	Straight Jack	EZ-200-SF-SS-X	3190-6007	<1.25:1 (6)	NA	Spring Finger	Crimp	A/G	0.9 (23.2)	0.40 (10.0)	0.019 (8.6)
14. SMA Male	Right Angle	EZ-200-SM-RA-SS-X	3190-6006	<1.30:1 (6)	Hex	Spring Finger	Crimp	A/G	1.0 (24.7)	0.70 (17.7)	0.019 (8.6)
15. TNC Male	Right Angle	EZ-200-TM-RA-X	3190-6008	<1.25:1 (6)	Hex	Spring Finger	Crimp	A/G	1.1 (27.5)	1.10 (28.8)	0.091 (41.7)
16. FME Female	Straight Jack	TC-200-FMEF-X	3190-6249	<1.25:1 (2)	Hex	Solder	Crimp	A/G	1.2 (29.3)	0.36 (9.2)	0.240 (6.1)
17. FME Male	Straight Plug	TC-200-FMEM-X	3190-6250	<1.25:1 (2)	NA	Solder	Crimp	A/G	1.1063(28.1)	0.4252 (10.8)	0.4213 (10.7)

\* Finish metals: N=Nickel, S=Silver, G=Gold, SS=Stainless Steel, A=Alballoy \*\*VSWR spec based on 3 foot cable with a connector pair\* Finish\* Finish metals: N=Nickel, S=Silver, G=Gold, SS=Stainless Steel, A=Alballoy \*\*VSWR spec based on 3 foot cable with a connector pair\* Finish



## Hardware Accessories

Type	Part Number	Stock Code	Description
Ground Kit	GK-S200TT	GK-S200TT	Standard Ground Kit (each)



## Install Tools

Type	Part Number	Stock Code	Description
Crimp Tool	CT-240/200/195/100	3190-667	Crimp tool for LMR-100, 195, 200 and 240 connectors
Cutting Tool	CCT-02	3192-165	Cable end flush cut tool
Deburr Tool	DBT-U	3192-001	Removes center conductor rough edges
Replacement Blade	RB-02	3192-166	Replacement blade for cutting tool
Strip Tool	CST-195/200	3192-102	Combination prep tool for LMR-195 and LMR-200
Replacement Blade	RB-CST	3192-086	Replacement blade kit for all CST strip tools

# LMR<sup>®</sup>-240

## Flexible Low Loss Communications Coax

### Ideal for...

- Jumper Assemblies in Wireless Communications Systems
- Short Antenna Feeder runs (e.g. WLL, GPS, LMR, Mobile Antennas)
- Any application (e.g. WLL, GPS, LMR, WLAN, WISP, WiMax, SCADA, Mobile Antennas) requiring an easily routed, low loss RF cable



Part Description				Stock
Part Number	Application	Jacket	Color	Code
LMR-240	Outdoor	PE	Black	54021
LMR-240-DB	Outdoor/Watertight	PE	Black	54090
LMR-240-FR	Indoor/Outdoor Riser	CMR FRPE	Black	54029
LMR-240-FR-PVC	Indoor/Outdoor Riser	CMR FRPVC	Black	54214
LMR-240-PVC	General Purpose	PVC	Black	54140
LMR-240-PVC-W	General Purpose	PVC	White	54202
LMR-240-MA	Indoor & Mobile Antenna	PVC	Black	54046

Environmental Specifications			
Performance Property	°F	°C	
Installation Temperature Range	-40/+185	-40/+85	
Storage Temperature Range	-94/+185	-70/+85	
Operating Temperature Range	-40/+185	-40/+85	

Mechanical Specifications			
Performance Property	Units	US	(metric)
Bend Radius: installation	in. (mm)	0.75	(19.1)
Bend Radius: repeated	in. (mm)	2.5	(63.5)
Bending Moment	ft-lb (N-m)	0.25	(0.34)
Weight	lb/ft (kg/m)	0.034	(0.05)
Tensile Strength	lb (kg)	80	(36.3)
Flat Plate Crush	lb/in. (kg/mm)	20	(0.36)

Construction Specifications			
Description	Material	In.	(mm)
Inner Conductor	Solid BC	0.056	(1.42)
Dielectric	Foam PE	0.150	(3.81)
Outer Conductor	Aluminum Tape	0.155	(3.94)
Overall Braid	Tinned Copper	0.178	(4.52)
Jacket	(see table)	0.240	(6.10)

Electrical Specifications			
Performance Property	Units	US	(metric)
Velocity of Propagation	%	83	
Dielectric Constant	NA	1.42	
Time Delay	nS/ft (nS/m)	1.21	(3.97)
Impedance	ohms	50	
Capacitance	pF/ft (pF/m)	24.2	(79.4)
Inductance	uH/ft (uH/m)	0.060	(0.20)
Shielding Effectiveness	dB	>90	
DC Resistance			
Inner Conductor	ohms/1000ft (/km)	3.2	(10.5)
Outer Conductor	ohms/1000ft (/km)	3.89	(12.8)
Voltage Withstand	Volts DC		1500
Jacket Spark	Volts RMS		5000
Peak Power	kW		5.6

MES MICROWAVE

**Attenuation vs. Frequency (typical)**

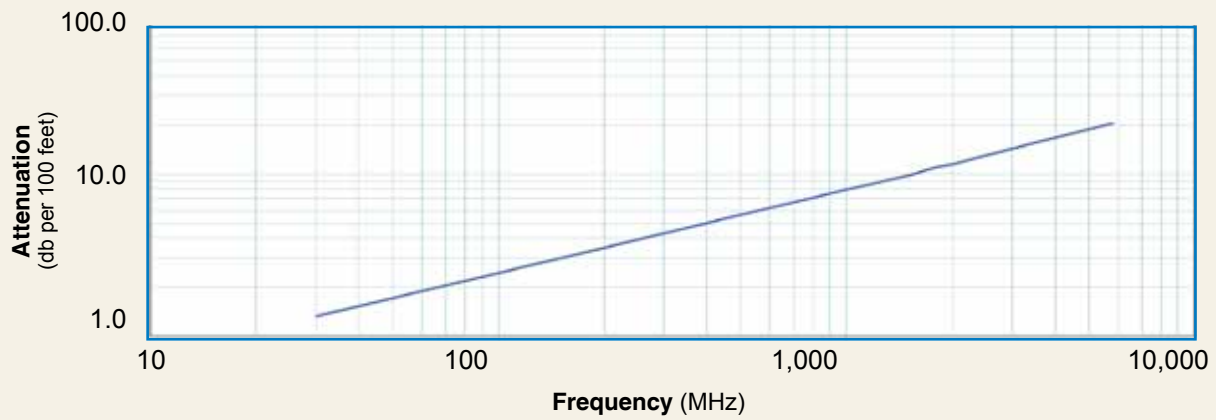

Frequency (MHz)	30	50	150	220	450	900	1500	1800	2000	2500	5800	8000
<b>Attenuation dB/100 ft</b>	1.3	1.7	3.0	3.7	5.3	7.6	9.9	10.9	11.5	12.9	20.4	24.3
<b>Attenuation dB/100 m</b>	4.4	5.7	9.9	12.0	17.3	24.8	32.4	35.6	37.7	42.4	66.8	79.7
<b>Avg. Power kW</b>	1.49	1.15	0.66	0.54	0.38	0.26	0.20	0.18	0.17	0.15	0.10	0.08

**Calculate Attenuation =**

$(0.242080) \cdot \sqrt{\text{FMHz}} + (0.000330) \cdot \text{FMHz}$  (interactive calculator available at [http://www.timesmicrowave.com/cable\\_calculators](http://www.timesmicrowave.com/cable_calculators))

**Attenuation:**

VSWR=1.0 ; Ambient = +25°C (77°F)

**Power:** VSWR=1.0; Ambient = +40°C; Inner Conductor = 100°C (212°F); Sea Level; dry air; atmospheric pressure; no solar loading

# LMR<sup>®</sup>-240 Flexible Low Loss Communications Coax



## Connectors

Interface	Description	Part Number	Stock Code	VSWR** Freq. (GHz)	Coupling Nut	Inner Contact Attach	Outer Contact Attach	Finish* Body /Pin	Length in (mm)	Width in (mm)	Weight lb (g)
1. F Male	Straight Plug	TC-240-FM-X	3190-2891	<1.25:1 (2.5)	Knurl	Solder	Crimp	N/G	1.1 (28)	0.45 (11.4)	0.014 (6.4)
2. N Male	Straight Plug	EZ-240-NMH-X	3190-2893	<1.25:1 (2.5)	Hex/Knurl	Spring Finger	Crimp	A/G	1.5 (38.1)	0.78 (19.8)	0.086 (39.0)
3. N Male	Right Angle	EZ-240-NMH-RA-X	3190-6143	<1.35:1 (6)	Hex	Spring Finger	Crimp	A/G	1 (25.1)	1.04 (26.4)	0.115 (52.0)

Connectors													
Interface	Description	Part Number	Stock Code	VSWR** Freq. (GHz)	Coupling Nut	Inner Contact Attach	Outer Contact Attach	Finish* Body /Pin	Length in (mm)	Width in (mm)	Weight lb (g)		
4. N Male	RightAngle	TC-240-NMH-RA-D	3190-2426	<1.35:1 (6)	Hex/Knurl	Solder	Crimp	A/G	1.2 (32.4)	1.22 (31.0)	0.091 (41.7)		
5. N Male	Straight Plug	TC-240-NMH-X	3190-2887*	<1.25:1 (2.5)	Hex/Knurl	Solder	Crimp	N/S	1.5 (38)	0.75 (19.1)	0.086 (39.0)		
6. N Male	Straight Plug	TC-240-NMC	3190-244	<1.25:1 (2.5)	Knurl	Solder	Clamp	S/G	1.5 (38)	0.75 (19.1)	0.082 (37.2)		
7. 1.0/2.3 DIN	Straight Plug	EZ-240-1023M	3190-6283	<1.35:1 (2.5)	knurl	Spring Finger	Crimp	N/G	1.1 (228.5)	0.33 (8.5)	0.014 (6.63)		
8. N Female	Bulkhead Jack	TC-240-NF-BH-X	3190-2888	<1.25:1 (2.5)	NA	Solder	Crimp	A/G	1.7 (44)	0.88 (22.2)	0.115 (52.2)		
9. N Female	Panel Mount	TC-240-NF-PM-X	3190-2889*	<1.25:1 (6)	NA	Solder	Crimp	A/G	1.7 (44)	0.88 (22.2)	0.115 (52.2)		
10. N Female	Straight Jack	EZ-240-NF-X	3190-2795	<1.25:1 (6)	NA	Spring Finger	Crimp	A/G	1.4 (35.4)	0.62 (15.8)	0.040 (18.0)		
11. BNC Male	Straight Plug	TC-240-BMC	3190-242	<1.25:1 (2.5)	Knurl	Solder	Clamp	S/G	1.7 (43)	0.56 (14.2)	0.040 (18.1)		
12. BNC Male	Straight Plug	EZ-240-BM-X	3190-6120	<1.25:1 2.5	Knurl	Spring Finger	Crimp	A/G	1.3 (34)	0.58 (14.7)	0.043 (19.5)		
13. BNC Male	Straight Plug	TC-240-BM-X	3190-2890	<1.25:1 (2.5)	Knurl	Solder	Crimp	A/G	1.3 (34)	0.58 (14.7)	0.043 (19.5)		
14. BNC Male	RightAngle	TC-240-BM-RA-D	3190-2869	<1.25:1 (2)	Knurl	Solder	Crimp	A/G	1.0 (25.1)	0.57 (14.5)	0.115 (52.0)		
15. BNC Male	RightAngle	EZ-240-BM-RA-X	3190-2868	<1.30:1 (4)	KNURL	Spring Finger	Crimp	A/G	1.3 (33.6)	1.19 (30.1)	0.091 (41.7)		
16. TNC Male	Straight Plug	EZ-240-TM-X	3190-2725	<1.25:1 (2.5)	Knurl	Spring Finger	Crimp	N/G	1.4 (34.3)	0.59 (15.0)	0.043 (19.5)		
17. TNC Male	Straight Plug	TC-240-TM-X	3190-2797	<1.25:1 (2.5)	Knurl	Solder	Crimp	N/G	1.7 (43)	0.59 (15.0)	0.043 (19.5)		
18. TNC Male	Reverse Polarity	EZ-240-TM-RP-X	3190-2892	<1.25:1 (6)	Knurl	Spring Finger	Crimp	A/G	1.4 (36)	0.59 (15.0)	0.043 (19.5)		
19. TNC Male	RightAngle	TC-240-TM-RA-D	3190-2798	<1.25:1 (6)	Hex	Solder	Crimp	A/G	1.0 (25.1)	0.62 (15.7)	0.115 (52.0)		
20. TNC Female	Straight Jack	EZ-240-TF-X	3190-6204	<1.25:1 (6)	NA	Spring Finger	Crimp	A/G	1.1 (27.2)	0.87 (22.0)	0.033(15.0)		
21. TNC Female	Reverse Polarity	EZ-240-TF-RP-X	3190-6167	<1.35:1 (6)	NA	Spring Finger	Crimp	A/G	1.1 (27.2)	0.87 (22.0)	0.033(15.0)		
22. QMA Male	Straight Plug	EZ-240-QM-X	3190-2894	<1.25: (6)	Knurl	Spring Finger	Crimp	N/G	1.2 (30.0)	0.41 (10.5)	0.014 (6.35)		
23. QMA Male	RightAngle	EZ-240-QM-RA-X	3190-2895	<1.25: (<6)	Knurl	Spring Finger	Crimp	N/G	0.8 (20.3)	0.65 (16.5)	0.019 (8.62)		
24. SMA Male	Straight Plug	EZ-240-SM-X	3190-2897	<1.25: (6)	Hex	Spring Finger	Crimp	N/G	1.0 (25.4)	0.32 (8.1)	0.016 (7.26)		
25. SMA Male	Straight Plug	TC-240-SM-SS-X	3190-2898*	<1.25:1 (10)	Hex	Solder	Crimp	SS/G	1.0 (25)	0.32 (8.1)	0.016 (7.3)		
26. SMA Male	RightAngle	TC-240-SM-RA-SS-X	3190-2900*	<1.35:1 (6)	Hex	Solder	Crimp	SS/G	0.8 (20)	0.65 (16.5)	0.019 (8.6)		
27. SMA Male	RightAngle	EZ-240-SM-RA-X	3190-2899	<1.25:1 (6)	Hex	Spring Finger	Crimp	A/G	0.9 (22.8)	0.31 (7.9)	0.019 (8.6)		
28. SMA Male	Reverse Polarity	TC-240-SM-RP	3190-326	<1.25:1 (2.5)	Hex	Solder	Crimp	SS/G	1.0 (25)	0.32 (8.1)	0.016 (7.3)		
29. SMA Female	Bulkhead Jack	TC-240-SF-SS-BH-X	3190-2896*	<1.25:1 (2.5)	NA	Solder	Crimp	SS/G	1.1 (29)	0.31 (7.9)	0.019 (8.6)		
30. Mini-UHF	Straight Plug	TC-240-MUHF	3190-445	<1.25:1 (2.5)	Knurl	Solder	Crimp	N/G	1.1 (28)	0.45 (11.4)	0.014 (6.4)		
31. 7/16 Din Male	Straight Plug	TC-240-716M	3190-2982	<1.35:1 (3)	Hex	Spring Finger	Crimp	A/S	2.0 (50.5)	1.26 (32.0)	0.186 (84.4)		
32. 7/16 Din Male	Right Angle	TC-240-716M-RA-D	3190-2983	<1.35:1 (3)	Hex	Solder	Crimp	A/S	1.4 (34.3)	1.60 (40.6)	0.239 (108.5)		

\*Finish metals: N=Nickel, S=Silver, G=Gold, SS=Stainless Steel, A=Alballoy \*\*VSWR spec based on 3 foot cable with a connector pair \*Available in bulk pack

## Hardware Accessories

Type	Part Number	Stock Code	Description
Ground Kit	GK-S240TT	GK-S240TT	Standard Ground Kit (each)
Weatherproof Kit	WSB-240	3109-400	Weatherproof/Strain relief kit for LMR-240



WSB-240  
3109-400



GK-S240TT



CT-240/200/195/100  
3190-667



CCT-02  
3192-165



CST-240A  
3192-152



DBT-U  
3192-001



RB-CST  
3192-086

## Install Tools

Type	Part Number	Stock Code	Description
Crimp Tool	CT-240/200/195/100	3190-667	Crimp tool for LMR-100, 195, 200 and 240 connectors
Strip Tool	CST-240A	3192-152	Prep tool for LMR-240 connectors
Deburr Tool	DBT-U	3192-001	Removes center conductor rough edges
Cutting Tool	CCT-02	3192-165	Cable end flush cut tool
Replacement Blade	RB-02	3192-166	Replacement blade for cutting tool
Replacement Blade Kit	RB-CST	3192-086	Replacement blade kit for all CST strip tools

# LMR<sup>®</sup>-300 Flexible Low Loss Communications Coax

## Ideal for...

- Jumper Assemblies in Wireless Communications Systems
- Short Antenna Feeder runs
- Any application (e.g. WLL, GPS, LMR, WLAN, WISP, WiMax, SCADA, Mobile Antennas) requiring an easily routed, low loss RF cable



Part Description				Stock
Part Number	Application	Jacket Color		Code
LMR-300	Outdoor	PE	Black	54086
LMR-300-DB	Outdoor/Watertight	PE	Black	54114
LMR-300-FR	Indoor/Outdoor Riser CMR	FRPE	Black	54087
LMR-300-FR-PVC	Indoor/Outdoor Riser CMR	FRPVC	Black	54108
LMR-300-PVC	General Purpose	PVC	Black	54217
LMR-300-PVC-W	General Purpose	PVC	White	54203

Construction Specifications			
Description	Material	In.	(mm)
Inner Conductor	Solid BC	0.070	(1.78)
Dielectric	Foam PE	0.190	(4.83)
Outer Conductor	Aluminum Tape	0.196	(4.98)
Overall Braid	Tinned Copper	0.225	(5.72)
Jacket	(see table)	0.300	(7.62)

Environmental Specifications			
Performance Property	'F	°C	
Installation Temperature Range	-40/+185	-40/+85	
Storage Temperature Range	-94/+185	-70/+85	
Operating Temperature Range	-40/+185	-40/+85	

Electrical Specifications			
Performance Property	Units	US	(metric)
Velocity of Propagation	%	82	
Dielectric Constant	NA	1.38	
Time Delay	nS/ft (nS/m)	1.20	(3.92)
Impedance	ohms	50	
Capacitance	pF/ft (pF/m)	23.9	(78.4)
Inductance	uH/ft (uH/m)	0.060	(0.20)
Shielding Effectiveness	dB	>90	
DC Resistance			
Inner Conductor	ohms/1000ft (/km)	2.12	(7.0)
Outer Conductor	ohms/1000ft (/km)	2.21	(7.3)
Voltage Withstand	Volts DC		2000
Jacket Spark	Volts RMS		5000
Peak Power	kW		10

Mechanical Specifications			
Performance Property	Units	US	(metric)
Bend Radius: installation	in. (mm)	0.88	(22.2)
Bend Radius: repeated	in. (mm)	3.0	(76.2)
Bending Moment	ft-lb (N-m)	0.38	(0.52)
Weight	lb/ft (kg/m)	0.055	(0.08)
Tensile Strength	lb (kg)	120	(54.5)
Flat Plate Crush	lb/in. (kg/mm)	30	(0.54)

### Attenuation vs. Frequency (typical)

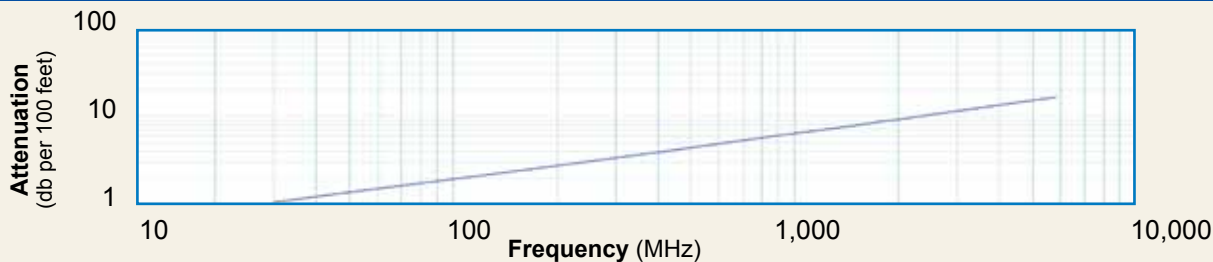

Frequency (MHz)	30	50	150	220	450	900	1500	1800	2000	2500	5800	8000
Attenuation dB/100 ft	1.1	1.4	2.4	2.9	4.2	6.1	7.9	8.7	9.2	10.4	16.5	19.8
Attenuation dB/100 m	3.5	4.5	7.9	9.6	13.8	19.9	26.0	28.7	30.3	34.2	54.2	65.0
Avg. Power kW	2.09	1.62	0.92	0.76	0.52	0.36	0.28	0.25	0.24	0.21	0.13	0.11

Calculate Attenuation =  $(0.191930) \cdot \sqrt{FMHz} + (0.000330) \cdot FMHz$  (interactive calculator available at [http://www.timesmicrowave.com/cable\\_calculators](http://www.timesmicrowave.com/cable_calculators))  
 Attenuation: VSWR=1.0 ; Ambient = +25°C (77°F) Power: VSWR=1.0; Ambient = +40°C; Inner Conductor = 100°C (212°F);  
 Sea Level; dry air; atmospheric pressure; no solar loading



Connectors											
Interface	Description	Part Number	Stock Code	VSWR** Freq. (GHz)	Coupling Nut	Inner Contact Attach	Outer Contact Attach	Finish* Body /Pin	Length in (mm)	Width in (mm)	Weight lb (g)
1. N Male	Right Angle	TC-300-NMH-RA-D	3190-2761	<1.30:1 (2.5)	Hex/Knurl	Solder	Crimp	N/S	1.4 (35)	1.41 (35.8)	0.130 (59.0)
2. N Male	Straight Plug	TC-300-NMH-X	3190-2861	<1.25:1 (6)	Hex/Knurl	Solder	Crimp	A/G	1.3 (33)	0.86 (21.8)	0.084 (38.1)
3. N Male	Straight Plug	EZ-300-NMH-X	3190-2420	<1.25:1 (6)	Hex	Spring finger	Crimp	A/G	1.3 (34)	0.87 (22.0)	0.077(34.95)
4. N Female	Straight Jack	EZ-300-NF-X	3190-3078	<1.25:1 (6)	NA	Solder	Crimp	A/G	1.4 (36.5)	0.87 (22.0)	0.040 (18.0)
5. TNC Male	Straight Plug	TC-300-TM	3190-500	<1.25:1 (2.5)	Knurl	Solder	Crimp	N/G	1.7 (43)	0.59 (15.0)	0.050 (22.7)
6. SMA Male	Straight Plug	TC-300-SM	3190-501	<1.25:1 (2.5)	Hex	Solder	Crimp	SS/G	1.0 (25)	0.35 (8.9)	0.018 (8.2)
7. SMA Female	Bulkhead Jack	TC-300-SF-BH	3190-590	<1.25:1 (2.5)	NA	Solder	Crimp	SS/G	1.1 (28)	0.31 (7.9)	0.022 (10.0)
8. TNC Male	Straight Plug	EZ-300-TM-X	3190-2421	<1.25:1 (6)	Hex	Spring finger	Crimp	A/G	1.3 (32)	0.66 (16.8)	0.058 (26.2)

\* Finish metals: N=Nickel, S=Silver, G=Gold, SS=Stainless Steel, A=Alballoy \*\*VSWR spec based on 3 foot cable with a connector pair

## Hardware Accessories

Type	Part Number	Stock Code	Description
Ground Kit	GK-S300TT	GK-S300TT	Standard Ground Kit (each)



## Install Tools

Type	Part Number	Stock Code	Description
Crimp Tool	CT-400/300	3190-666	Crimp tool for LMR-300 connectors
Deburr Tool	DBT-U	3192-001	Removes center conductor rough edges
Cutting Tool	CCT-02	3192-165	Cable end flush cut tool
Prep Tool	CST-300	3192-084	Prep tool for LMR-300 Connectors
Replacement Blade Kit	RB-CST	3192-086	Replacement blade kit for all CST strip tools
Replacement Blade	RB-02	3192-166	Replacement blade for cutting tool



# LMR<sup>®</sup>-400 Flexible Low Loss Communications Coax

## Ideal for...

- Drop-in replacement for RG-8/9913 Air-Dielectric type Cable
- Jumper Assemblies in Wireless Communications Systems
- Short Antenna Feeder runs
- Any application (e.g. WLL, GPS, LMR, WLAN, WISP, WiMax, SCADA, Mobile Antennas) requiring an easily routed, low loss RF cable
- **NEW!** Times Protect<sup>®</sup> LP-18-400 protector-series



Part Description					Stock
Part Number	Application	Jacket	Color	Code	
LMR-400	Outdoor	PE	Black	54001	
LMR-400-DB	Outdoor/Watertight	PE	Black	54091	
LMR-400-FR	Indoor/Outdoor Riser CMR	FRPE	Black	54030	
LMR-400-FR-PVC	Indoor/Outdoor Riser CMR	FRPVC	Black	54073	
LMR-400-PVC	General Purpose	PVC	Black	54218	
LMR-400-PVC-W	General Purpose	PVC	White	54204	

Construction Specifications			
Description	Material	In.	(mm)
Inner Conductor	Solid BCCAI	0.108	(2.74)
Dielectric	Foam PE	0.285	(7.24)
Outer Conductor	Aluminum Tape	0.291	(7.39)
Overall Braid	Tinned Copper	0.320	(8.13)
Jacket	(see table)	0.405	(10.29)

Environmental Specifications			
Performance Property	°F	°C	
Installation Temperature Range	-40/+185	-40/+85	
Storage Temperature Range	-94/+185	-70/+85	
Operating Temperature Range	-40/+185	-40/+85	

Electrical Specifications				
Performance Property	Units	US	(metric)	
Velocity of Propagation	%	84		
Dielectric Constant	NA	1.38		
Time Delay	nS/ft (nS/m)	1.20	(3.92)	
Impedance	ohms	50		
Capacitance	pF/ft (pF/m)	23.9	(78.4)	
Inductance	uH/ft (uH/m)	0.060	(0.20)	
Shielding Effectiveness	dB	>90		
DC Resistance				
Inner Conductor	ohms/1000ft (/km)	1.39	(4.6)	
Outer Conductor	ohms/1000ft (/km)	1.65	(5.4)	
Voltage Withstand	Volts DC	2500		
Jacket Spark	Volts RMS	8000		
Peak Power	kW	16		

Mechanical Specifications				
Performance Property	Units	US	(metric)	
Bend Radius: installation	in. (mm)	1.00	(25.4)	
Bend Radius: repeated	in. (mm)	4.0	(101.6)	
Bending Moment	ft-lb (N-m)	0.5	(0.68)	
Weight	lb/ft (kg/m)	0.068	(0.10)	
Tensile Strength	lb (kg)	160	(72.6)	
Flat Plate Crush	lb/in. (kg/mm)	40	(0.71)	



TIMES MICROWAVE

**Attenuation vs. Frequency (typical)**

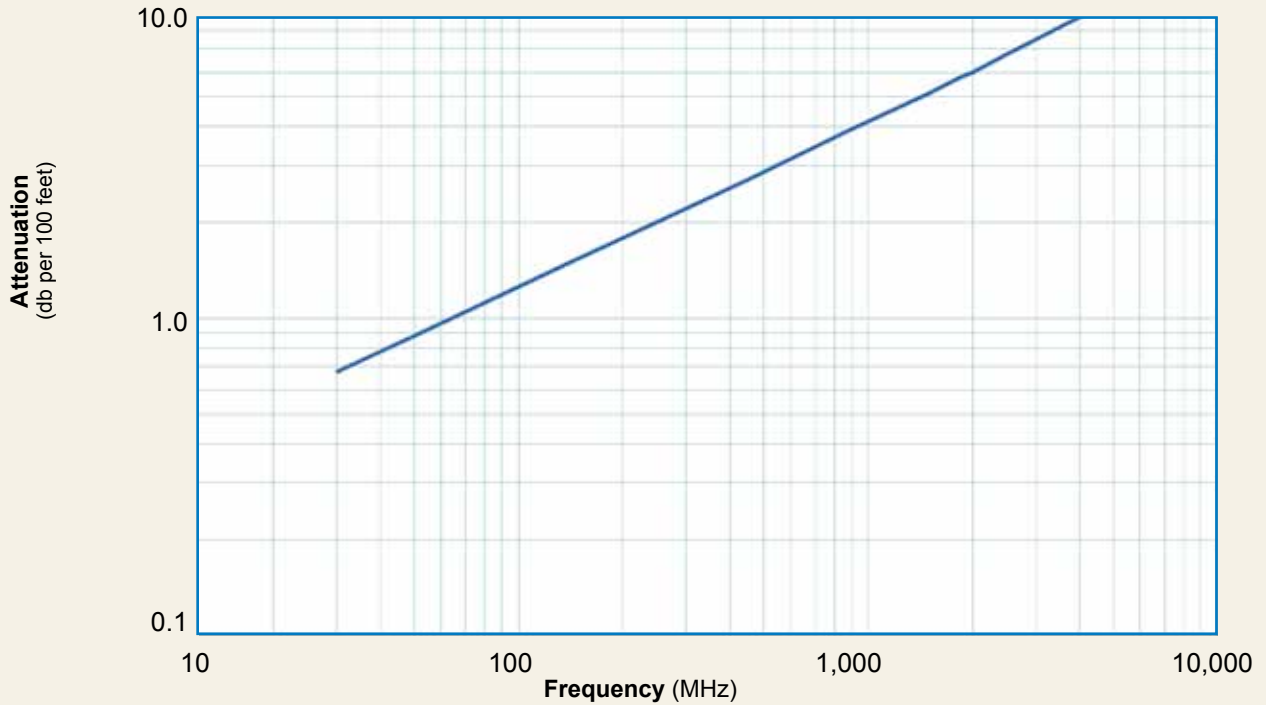

Frequency (MHz)	30	50	150	220	450	900	1500	1800	2000	2500	5800	8000
<b>Attenuation dB/100 ft</b>	0.7	0.9	1.5	1.9	2.7	3.9	5.1	5.7	6.0	6.8	10.8	13.0
<b>Attenuation dB/100 m</b>	2.2	2.9	5.0	6.1	8.9	12.8	16.8	18.6	19.6	22.2	35.5	42.7
<b>Avg. Power kW</b>	3.33	2.57	1.47	1.20	0.83	0.58	0.44	0.40	0.37	0.33	0.21	0.17

**Calculate Attenuation =**

$(0.122290) \cdot \sqrt{\text{FMHz}} + (0.000260) \cdot \text{FMHz}$  (interactive calculator available at [http://www.timesmicrowave.com/cable\\_calculators](http://www.timesmicrowave.com/cable_calculators))

**Attenuation:**

VSWR=1.0 ; Ambient = +25°C (77°F)

**Power:**

VSWR=1.0; Ambient = +40°C; Inner Conductor = 100°C (212°F); Sea Level; dry air; atmospheric pressure; no solar loading

# LMR<sup>®</sup>-400 Flexible Low Loss Communications

Connectors													
Interface	Description	Part Number	Stock Code	VSWR**	Coupling	Inner Contact	Outer Contact	Finish*	Length in	Width in	Weight lb	Weight (g)	
				Freq. (GHz)	Nut	Attach	Attach	/Pin	(mm)	(mm)		(g)	
1.	4.1-9.5 mini DIN Female	Straight Jack	EZ-400-4195F-X	3190-2968	<1.25:1 (6)	Hex	Spring Finger Crimp	A/G	1.8 (45.0)	0.55 (14.0)	0.074 (33.6)		
2.	4.1-9.5 mini DIN Female	Straight Plug	EZ-400-4195M-X	3190-2969	<1.25:1 (6)	Hex	Spring Finger Crimp	A/G	1.5 (38.1)	0.89 (22.6)	0.103 (46.8)		
3.	7-16 DIN Female	Straight Jack	TC-400-716-FC	3190-376	<1.25:1 (2.5)	N/A	Solder Clamp	S/S	1.6 (41)	1.13 (28.7)	0.281 (127.5)		
4.	7-16 DIN	Right Angle	TC-400-716M-RA-D	3190-2598	<1.35:1 (6)	Hex	Solder Crimp	A/S	1.7 (43.20)	1.98 (50.3)	0.374 (169.5)		
5.	7-16 DIN Male	Straight Plug	EZ-400-716M-X	3190-2524	<1.25:1 (6)	Hex	Spring Finger Crimp	A/G	1.6 (39.5)	1.38 (35)	0.277 (126.0)		
6.	7-16 DIN Male	Straight Plug	TC-400-716M-X	3190-2597	<1.25:1 (6)	Hex	Solder Crimp	A/S	1.6 (39.5)	1.42 (36.0)	0.320 (145.0)		
7.	7-16 DIN Male	Straight Plug	TC-400-716-MC	3190-279	<1.25:1 (2.5)	Hex	Solder Clamp	S/S	1.4 (36)	1.40 (35.6)	0.268 (121.6)		
8.	7-16 DIN Male	Right Angle	TC-400-716MC-RA	3190-1671	<1.25:1 (<3)	Hex	Solder Clamp	A/S	2.4 (61.5)	1.88 (47.8)	0.35 (159)		
9.	7-16 DIN Male	Right Angle	EZ-400-716M-RA-X	3190-2545	<1.35:1 (6)	Hex	Spring Finger Crimp	A/G	1.6 (41.7)	1.75 (44.3)	0.374 (0.17)		
10.	BNC Male	Straight Plug	TC-400-BM-X	3190-6232	<1.30:1 (4)	Knurl	Solder Crimp	A/G	1.8 (46.8)	0.60 (14.5)	0.630 (28.6)		
11.	BNC Male	Straight Plug	EZ-400-BM-X	3190-2852	<1.35:1 (2)	Knurl	Spring Finger Crimp	A/G	1.7 (42.7)	0.56 (14.2)	0.066 (29.9)		
12.	BNC Male	Right Angle	EZ-400-BM-RA-X	3190-2847	<1.35:1 (2)	Knurl	Spring Finger Crimp	A/G	1.9 (48.0)	1.32 (33.5)	0.097 (44.0)		
13.	HN Male	Straight Plug	TC-400-HNM	3190-923	<1.25:1 (<1)	Knurl	Solder Clamp	S/G	2.3 (59.2)	0.88 (22.4)	0.25 (113.4)		
14.	HN Male	Right Angle	TC-400-HNM-RA	3190-2541	<1.25:1 (2.5)	Hex	Solder Crimp	A/G	1.6 (41.4)	1.56 (39.6)	0.198 (90.0)		
15.	UHF Male	Straight Plug	EZ-400-UM	3190-997	<1.25:1 (2.5)	Knurl	Spring Finger Crimp	N/G	1.8 (48)	0.80 (20.3)	0.076 (34.4)		
16.	Mini-UHF	Straight Plug	TC-400-MUHF	3190-520	<1.25:1 (2.5)	Knurl	Solder Crimp	N/G	1.1 (28)	0.50 (12.7)	0.020 (9.1)		
17.	N Female	Straight Jack	TC-400-NFC	3190-299	<1.25:1 (2.5)	N/A	Solder Clamp	N/S	1.6 (41)	0.75 (19.1)	0.119 (54.0)		
18.	N Female	Straight Jack	EZ-400-NF-X	3190-2818	<1.25:1 (2.5)	N/A	Spring Finger Crimp	N/G	1.8 (45)	0.66 (16.8)	0.105 (47.6)		
19.	N Female	Straight Jack	TC-400-NF-X	3190-2815	<1.25:1 (2.5)	N/A	Solder Crimp	N/G	1.8 (45)	0.66 (16.8)	0.105 (47.6)		
20.	N Female	Bulkhead Jack	EZ-400-NF-BH	3190-518*	<1.25:1 (2.5)	N/A	Spring Finger Crimp	N/G	1.8 (46)	0.88 (22.4)	0.102 (46.3)		
21.	N Female	Bulkhead Jack	TC-400-NFC-BH (A)	3190-872	<1.25:1 (2.5)	N/A	Solder Clamp	A/G	1.8 (46)	0.88 (22.4)	0.145 (65.8)		
22.	N Male	Straight Plug	SC-400-NM	3190-1454	<1.25:1 (2.5)	Knurl	Solder Crimp	N/G	1.5 (38)	0.75 (19.1)	0.090 (40.8)		
23.	N Male	Straight Plug	TC-400-NMC	3190-6077	<1.25:1 (2.5)	Knurl	Solder Clamp	N/G	1.5 (38)	0.70 (17.8)	0.121 (54.9)		
24.	N Male	Straight Plug	EZ-400-NMC-2-D	3190-2640	<1.25:1 (2.5)	Hex/Knurl	Spring Finger Crimp	N/G	1.5 (38)	0.75 (19.1)	0.121 (54.9)		
25.	N Male	Straight Plug	EZ-400-NMH-X	3190-2590	<1.25:1 (10)	Hex/Knurl	Spring Finger Crimp	A/G	1.5 (38)	0.89 (22.6)	0.103 (46.8)		
26.	N Male	Straight Plug	TC-400-NMH-X	3190-2626	<1.25:1 (10)	Hex/Knurl	Solder Crimp	A/G	1.5 (38)	0.89 (22.6)	0.113 (51.3)		
27.	N Male	Right Angle	EZ-400-NMH-RA-X	3190-2638	<1.35:1 (6)	Hex/Knurl	Spring Finger Crimp	A/G	1.87 (47)	1.42 (36.0)	0.177 (80.2)		
28.	N Male	Right Angle	TC-400-NMH-RA-SS	3190-1668	<1.25:1 (2.5)	Hex	Solder Crimp	SS/G	1.5 (38.1)	0.89 (2.6)	0.130 (59.0)		
29.	N Male	Right Angle	TC-400-NMH-RA-D	3190-2293*	<1.35:1 (6)	Hex/Knurl	Solder Crimp	A/G	1.8 (46)	1.25 (31.8)	0.130 (59.0)		
30.	N Male	Right Angle	TC-400-NMC-RA (A)	3190-870	<1.35:1 (2.5)	Hex	Solder Clamp	A/G	1.8 (46)	1.25 (31.8)	0.150 (68.0)		
31.	N Male	Reverse Polarity	TC-400-NM-RP	3190-960	<1.25:1 (2.5)	Knurl	Solder Crimp	N/G	1.5 (38)	0.75 (19.1)	0.090 (40.8)		
32.	QN Male	Straight Plug	EZ-400-QNM-X	3190-2979	<1.25:1 (6)	Hex	Spring Finger Crimp	A/G	1.5 (38)	0.89 (22.6)	0.103 (46.8)		
33.	QN Male	Straight Plug	TC-400-QNM-X	3190-6212	<1.25:1 (6)	Hex	Solder Crimp	A/G	2.0 (50.2)	0.74 (18.9)	0.103 (46.8)		
34.	QN Male	Right Angle	EZ-400-QNM-RA-X	3190-2981	<1.25:1 (6)	Hex	Spring Finger Crimp	A/G	1.9 (47.0)	1.42 (36.0)	0.177 (80.2)		
35.	QN Female	Straight Jack	EZ-400-QNF-X	3190-2980	<1.25:1 (6)	N/A	Spring Finger Crimp	A/G	1.8 (45.0)	0.66 (16.8)	0.105 (47.6)		
36.	SMA Male	Straight Plug	TC-400-SM-X	3190-3046	<1.25:1 (8)	Hex	Solder Crimp	N/G	1.2 (29)	0.50 (12.7)	0.032 (14.5)		
37.	SMA Female	Straight Jack	TC-400-SF-X	3190-6174	<1.35:1 (6)	N/A	Solder Crimp	A/G	1.2 (29.7)	0.50 (12.7)	0.026 (12.0)		
38.	TNC Female	Reverse Polarity	TC-400-TF-RP	3190-1063	<1.25:1 (2.5)	N/A	Solder Crimp	N/G	1.8 (46)	0.55 (14.0)	0.074 (33.6)		
39.	TNC Female	Reverse Polarity	EZ-400-TF-RP	3190-795	<1.25:1 (2.5)	N/A	Spring Finger Crimp	A/G	1.8 (46)	0.55 (14.0)	0.074 (33.6)		
40.	TNC Female	Straight Jack	EZ-400-TF-X	3190-3049	<1.25:1 (6)	N/A	Spring Finger Crimp	A/G	1.8 (45)	0.55 (14.0)	0.074 (33.6)		
41.	TNC Female	Straight Jack	TC-400-TF-X	3190-3051	<1.25:1 (6)	N/A	Solder Crimp	A/G	1.8 (45.0)	0.55 (14.0)	0.074 (33.6)		
42.	TNC Male	Straight Plug	TC-400-TM-X	3190-2532	<1.25:1 (6)	Hex/Knurl	Solder Crimp	A/G	1.9 (48)	0.67 (17.5)	0.075 (34.3)		
43.	TNC Male	Straight Plug	EZ-400-TM-X	3190-2533	<1.25:1 (6)	Hex/Knurl	Spring Finger Crimp	A/G	1.9 (48)	0.67 (17.5)	0.075 (34.3)		
44.	TNC Male	Reverse Polarity	TC-400-TM-RP	3190-1062	<1.25:1 (2.5)	Knurl	Solder Crimp	N/G	1.7 (43)	0.59 (15.0)	0.074 (33.6)		
45.	TNC Male	Reverse Polarity	EZ-400-TM-RP	3190-794	<1.25:1 (2.5)	Knurl	Spring Finger Crimp	A/G	1.7 (43)	0.59 (15.0)	0.074 (33.6)		
46.	TNC Male	Right Angle	TC-400-TM-RA-D	3190-2671	<1.35:1 (6)	Hex/Knurl	Solder Crimp	A/G	1.4 (35)	1.41 (35.8)	0.130 (59.0)		
47.	TNC Male	Right Angle	EZ-400-TM-RA-X	3190-2800	<1.24:1 (6)	Hex	Spring Finger Crimp	A/G	2.0 (50.0)	0.62 (15.7)	0.130 (59.0)		
48.	TNC Male	Right Angle RP	TC-400-TM-RP-RA-D	3190-6147	<1.35:1 (6)	Hex	Solder Crimp	A/G	1.4 (36.0)	1.20 (30.3)	0.130 (59.0)		

\* Finish metals: N=Nickel, S=Silver, G=Gold, SS=Stainless Steel, A=Alballoy \*\*VSWR spec based on 3 foot cable with a connector \*Available in bulk pack

<p>1-2</p>  <p>EZ-400-4195F-X / 3190-2968 TC-400-4195M-X / 3190-2969</p>	<p>3</p>  <p>TC-400-716FC 3190-376</p>	<p>4</p>  <p>TC-400-716M-RA-D 3190-2598</p>	<p>5</p>  <p>EZ-400-716M-X 3190-2524</p>
<p>6</p>  <p>TC-400-716M-X 3190-2597</p>	<p>7</p>  <p>TC-400-716MC 3190-279</p>	<p>8</p>  <p>TC-400-716MC-RA 3190-1671</p>	<p>9</p>  <p>EZ-400-716M-RA-X 3190-2545</p>
<p>10</p>  <p>TC-400-BM-X 3190-6232</p>	<p>11</p>  <p>EZ-400-BM-X 3190-2852</p>	<p>12</p>  <p>EZ-400-BM-RA-X 3190-2847</p>	<p>13</p>  <p>TC-400-HNM 3190-923</p>
<p>14</p>  <p>TC-400-HNM-RA 3190-2541</p>	<p>15</p>  <p>EZ-400-UM 3190-997</p>	<p>16</p>  <p>TC-400-MUHF 3190-520</p>	<p>17</p>  <p>TC-400-NFC 3190-299</p>
<p>18</p>  <p>EZ-400-NF-X 3190-2818</p>	<p>19</p>  <p>TC-400-NF-X 3190-2815</p>	<p>20</p>  <p>EZ-400-NF-BH 3190-518</p>	<p>21</p>  <p>TC-400-NFC-BH (A) 3190-872</p>
<p>22</p>  <p>SC-400-NM 3190-1454</p>	<p>23</p>  <p>TC-400-NMC 3190-6077</p>	<p>24</p>  <p>EZ-400-NMC-2-D 3190-2640</p>	<p>25</p>  <p>EZ-400-NMH-X 3190-2590</p>
<p>26</p>  <p>TC-400-NMH-X 3190-2626</p>	<p>27</p>  <p>EZ-400-NMH-RA-X 3190-2638</p>		

<p>28 TC-400-NMH-RA-SS 3190-1668</p> 	<p>29 TC-400-NMH-RA-D 3190-2293</p> 	<p>30 TC-400-NMC-RA (A) 3190-870</p> 	<p>31 TC-400-NM-RP 3190-960</p> 
<p>32 EZ-400-QNM-X 3190-2979</p> 	<p>33 TC-400-QNM-X 3190-6212</p> 	<p>34 EZ-400-QNM-RA-X 3190-2981</p> 	<p>35 EZ-400-QNF-X 3190-2980</p> 
<p>36 TC-400-SM-X 3190-3046</p> 	<p>37 TC-400-SF-X 3190-6174</p> 	<p>38-39 TC-400-TF-RP / 3190-1063 EZ-400-TF-RP / 3190-795</p> 	<p>40-41 EZ-400-TF / 3190-3049 TC-400-TF-X / 3190-3051</p> 
<p>42-43 TC-400-TM-X / 3190-2532 EZ-400-TM-X / 3190-2533</p> 	<p>44-45 TC-400-TM-RP / 3190-1062 EZ-400-TM-RP / 3190-794</p> 	<p>46-47 TC-400-TM-RA-D 3190-2671 EZ-400-TM-RA-X 3190-2800</p> 	<p>48 TC-400-TM-RP-RA-D 3190-6147</p> 

## Hardware

<p>HG-400T</p> 	<p>GK-S400TT</p> 	<p>IPB-400-NM 3109-417-1</p> 	<p>IPB-400-NF 3109-417-2</p> 
			<p>WSB-400 3109-394</p> 

Type	Part Number	Stock Code	Description
Hoisting Grip	HG-400T	HG-400T	Laced Type (each)
Ground Kit	GK-S400TT	GK-S400TT	Standard Ground Kit (each)
Weather Proof Boots	3109-417-1	IPB-400 NM	LMR-400 Male IP boot suitable for type N, TNC, BNC, 4310, 4195
Weather Proof Boots	3109-417-2	IPB-400 NM	LMR-400 Female IP boots suitable for type N, TNC, BNC, 4310, 4195
Weather Seal Strain Relief Boots	3109-394	WSB-400	Weather seal strain relief boots (10 pk) for use with most popular LMR-400-X series connectors



## Install Tools

Type	Part Number	Stock Code	Description
Crimp Tool	CT-U	3192-181	Crimp Handle
Crimp Dies	Y1719	3190-202	.429" Hex Dies
Crimp Tool	CT-400/300	3190-666	Crimp tool for LMR 400 connectors
Crimp Rings	CR-400	3190-830	Crimp rings for TC/EZ-400 connectors (package of 10)
Strip Tool	ST-400C-2	3190-1972	Prep tool for EZ-400-NMC-2 two piece clamp style connector
Strip Tool	CST-400	3192-004	Combination prep tool for LMR-400 crimp and clamp style connectors
Mid-Span Strip Tool	GST-400	3190-2174	For ground strap attachment
Replacement Blades	RB-456	3190-421	Replacement blades for Strip Tool
Deburr Tool	DBT-U	3192-001	Removes center conductor rough edges
Cutting Tool	CCT-02	3192-165	Cable end flush cut tool
Replacement Blade	RB-02	3192-166	Replacement blade for cutting tool
Tool Kit	TK-400EZ	3190-1601	Tool kit for LMR-400 Crimp Connectors (includes CCT-02, CST-400, CT-400/300, Tool Pouch)
Replacement Blade Kit	RB-CST	3192-086	Replacement blade kit for all CST strip tools

# LMR<sup>®</sup>-500 Flexible Low Loss Communications Coax

Ideal for...

- Jumper Assemblies in Wireless Communications Systems
- Short Antenna Feeder runs
- Any application (e.g. WLL, GPS, LMR, WLAN, WISP, WiMax, SCADA, Mobile Antennas) requiring an easily routed, low loss RF cable



Part Description				Stock
Part Number	Application	Jacket Color		Code
LMR-500	Outdoor	PE	Black	54002
LMR-500-DB	Outdoor/Watertight	PE	Black	54092
LMR-500-FR	Indoor/Outdoor Riser	CMR FRPE	Black	54031

Construction Specifications			
Description	Material	In.	(mm)
Inner Conductor	Solid BCCA1	0.142	(3.61)
Dielectric	Foam PE	0.370	(9.40)
Outer Conductor	Aluminum Tape	0.376	(9.55)
Overall Braid	Tinned Copper	0.405	(10.29)
Jacket	(see table)	0.500	(12.70)

Mechanical Specifications			
Performance Property	Units	US	(metric)
Bend Radius: installation	in. (mm)	1.25	(31.8)
Bend Radius: repeated	in. (mm)	5.0	(127.0)
Bending Moment	ft-lb (N-m)	1.75	(2.37)
Weight	lb/ft (kg/m)	0.097	(0.14)
Tensile Strength	lb (kg)	260	(118.0)
Flat Plate Crush	lb/in. (kg/mm)	50	(0.89)

Electrical Specifications			
Performance Property	Units	US	(metric)
Velocity of Propagation	%	82	
Dielectric Constant	NA	1.35	
Time Delay	nS/ft (nS/m)	1.18	(3.88)
Impedance	ohms	50	
Capacitance	pF/ft (pF/m)	23.6	(77.5)
Inductance	uH/ft (uH/m)	0.059	(0.19)
Shielding Effectiveness	dB	>90	
DC Resistance			
Inner Conductor	ohms/1000ft (/km)	0.82	(2.7)
Outer Conductor	ohms/1000ft (/km)	1.27	(4.2)
Voltage Withstand	Volts DC	3000	
Jacket Spark	Volts RMS	8000	
Peak Power	kW	22	

Environmental Specifications		
Performance Property	°F	°C
Installation Temperature Range	-40/+185	-40/+85
Storage Temperature Range	-94/+85	-70/+85
Operating Temperature Range	-40/+185	-40/+85

Attenuation vs. Frequency (typical)

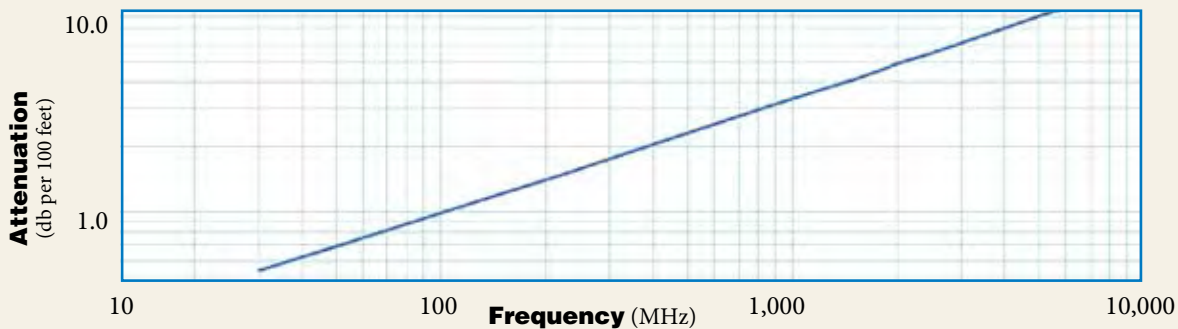

Frequency (MHz)	30	50	150	220	450	900	1500	1800	2000	2500	5800	8000
Attenuation dB/100 ft	0.5	0.7	1.2	1.5	2.2	3.1	4.1	4.6	4.8	5.5	8.9	10.7
Attenuation dB/100 m	1.8	2.3	4.0	4.9	7.1	10.3	13.6	15.0	15.9	18.0	29.1	35.2
Avg. Power kW	4.400	3.393	1.931	1.583	1.088	0.752	0.569	0.515	0.485	0.428	0.264	0.22

Calculate Attenuation = (0.096590) √FMHz + (0.000260) • FMHz (interactive calculator available at [http://www.timesmicrowave.com/cable\\_calculators](http://www.timesmicrowave.com/cable_calculators))  
 Attenuation: VSWR=1.0 ; Ambient = +25°C (77°F) Power: VSWR=1.0; Ambient = +40°C; Inner Conductor = 100°C (212°F);  
 Sea Level; dry air; atmospheric pressure; no solar loading



**Connectors**

Interface	Description	Part Number	Stock Code	VSWR Freq. (GHz)	Coupling Nut	Inner Contact Attach	Outer Contact Attach	Finish* /Pin	Length in (mm)	Width in (mm)	Weight lb	Weight (g)
1. 7-16 DIN Female	Straight Plug	TC-500-716F-X	3190-2906	<1.30:1 (6)	N/A	Solder	Crimp	A/S	1.8 (45.9)	1.14 (29.0)	0.298 (135.0)	
2. 7-16 DIN Male	Right Angle	TC-500-716M-RA-D	3190-6079	<1.30:1 (6)	Hex	Solder	Crimp	A/S	1.8 (44.9)	1.60(41.6)	0.370 (168.0)	
3. N Male	Straight Plug	TC-500-NMH-X	3190-2514	<1.35:5 (6)	Hex/Knurl	Solder	Crimp	A/G	1.8 (45)	0.87 (22.0)	0.099 (45.0)	
4. N Male	Straight Plug	EZ-500-NMH-X	3190-2596	<.35:1 (6)	Hex/Knurl	Spring Finger	Crimp	A/G	1.7 (44)	0.83 (21.0)	0.111 (50.5)	
5. N Male	Right Angle	TC-500-NMH-RA-D	3190-2970	<1.25:1 (6)	Hex/Knurl	Solder	Crimp	A/G	1.5 (39)	1.6 (42.0)	0.279 (127.0)	
6. N Female	Straight Jack	TC-500-NFC	3190-215	<1.25:1 (2.5)	N/A	Solder	Clamp	S/G	2.2 (56)	0.94 (23.9)	0.215 (97.5)	
7. N Female	Bulkhead Kit	BHA-KIT	3190-223	<1.25:1 (2.5)	N/A	N/A	N/A	N/A	N/A	N/A	N/A	0.014 (6.4)
8. N Male	Right Angle	TC-500-NMC-RA	3190-227	<1.25:1 (2.5)	Hex	Solder	Clamp	S/G	2.4 (61)	1.5 (38.1)	0.275 (124.7)	
9. TNC Male	Straight Plug	TC-500-TM-X	3190-6009	<1.25:1 (2.5)	Hex	Solder	Crimp	N/G	1.5 (38)	1.62 (15.7)	0.082 (28.1)	
10. TNC Female	Straight Jack	TC-500-TF-X	3190-6010	<1.30:1 (6)	N/A	Solder	Crimp	A/G	1.8 (44.5)	0.87 (22.0)	0.077 (35.0)	
11. UHF Male	Straight Plug	TC-500-UMC	3190-354	<1.25:1 (2.5)	Knurl	Solder	Clamp	S/G	2.1 (53)	0.88 (22.4)	0.215 (97.5)	

\* Finish metals: N=Nickel, S=Silver, G=Gold, SS=Stainless Steel, A=Alballoy \*Available in bulk pack

**Install Tools**



Type	Part Number	Stock Code	Description
Crimp Tool	CT-U	3192-181	Crimp Handle
Crimp Dies	Y151	3190-465	.532" Hex Dies
Strip Tool	CST-500	3192-075	For Crimp & Clamp Style Connectors
Crimp Tool	CT-500	3192-169	Crimp tool for LMR 500 Connectors
Deburr Tool	DBT-U	3192-001	Removes center conductor rough edges
Cutting Tool	CCT-02	3192-165	Cable End Flush Cut Tool
Replacement Blade Kit	RB-CST	3192-086	Replacement blade kit for strip tools
Replacement Blade	RB-02	3192-166	Replacement Blade for Cutting Tool

# LMR<sup>®</sup>-600 Flexible Low Loss Communications Coax

Ideal for...

- Jumper Assemblies in Wireless Communications Systems
- Short Antenna Feeder runs
- Any application (e.g. WLL, GPS, LMR, WLAN, WISP, WiMax, SCADA, Mobile Antennas) requiring an easily routed, low loss RF cable

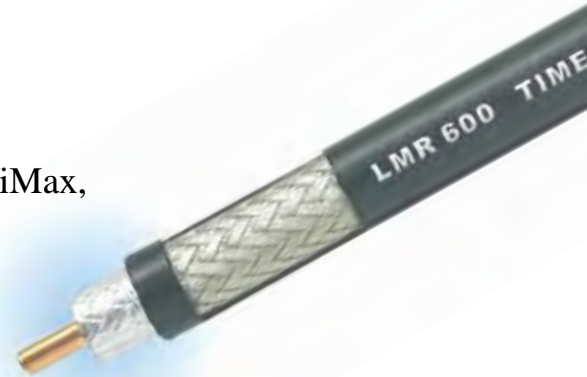

Part Description				Stock
Part Number	Application	Jacket Color	Code	
LMR-600	Outdoor	PE	Black	54003
LMR-600-DB	Outdoor/Watertight	PE	Black	54093
LMR-600-FR	Indoor/Outdoor Riser CMR	FRPE	Black	54032
LMR-600-FR-PVC	Indoor/Outdoor Riser CMR	FRPVC	Black	54074
LMR-600-PVC	General Purpose	PVC	Black	54219
LMR-600-PVC-W	General Purpose	PVC	White	54206

Construction Specifications			
Description	Material	In.	(mm)
Inner Conductor	Solid BCCAI	0.176	(4.47)
Dielectric	Foam PE	0.455	(11.56)
Outer Conductor	Aluminum Tape	0.461	(11.71)
Overall Braid	Tinned Copper	0.490	(12.45)
Jacket	(see table)	0.590	(14.99)

Mechanical Specifications			
Performance Property	Units	US	(metric)
Bend Radius: installation	in. (mm)	1.50	(38.1)
Bend Radius: repeated	in. (mm)	6.0	(152.4)
Bending Moment	ft-lb (N-m)	2.75	(3.73)
Weight	lb/ft (kg/m)	0.131	(0.20)
Tensile Strength	lb (kg)	350	(158.9)
Flat Plate Crush	lb/in. (kg/mm)	60	(1.07)

Environmental Specifications		
Performance Property	°F	°C
Installation Temperature Range	-40/+185	-40/+85
Storage Temperature Range	-94/+185	-70/+85
Operating Temperature Range	-40/+185	-40/+85

Electrical Specifications			
Performance Property	Units	US	(metric)
Velocity of Propagation	%	85	
Dielectric Constant	NA	1.32	
Time Delay	nS/ft (nS/m)	1.17	(3.83)
Impedance	ohms	50	
Capacitance	pF/ft (pF/m)	23.4	(76.6)
Inductance	uH/ft (uH/m)	0.058	(0.19)
Shielding Effectiveness	dB	>90	
DC Resistance			
Inner Conductor	ohms/1000ft (/km)	0.53	(1.7)
Outer Conductor	ohms/1000ft (/km)	1.2	(3.9)
Voltage Withstand	Volts DC	4000	
Jacket Spark	Volts RMS	8000	
Peak Power	kW	40	



S MICROWAVE

Attenuation vs. Frequency (typical)

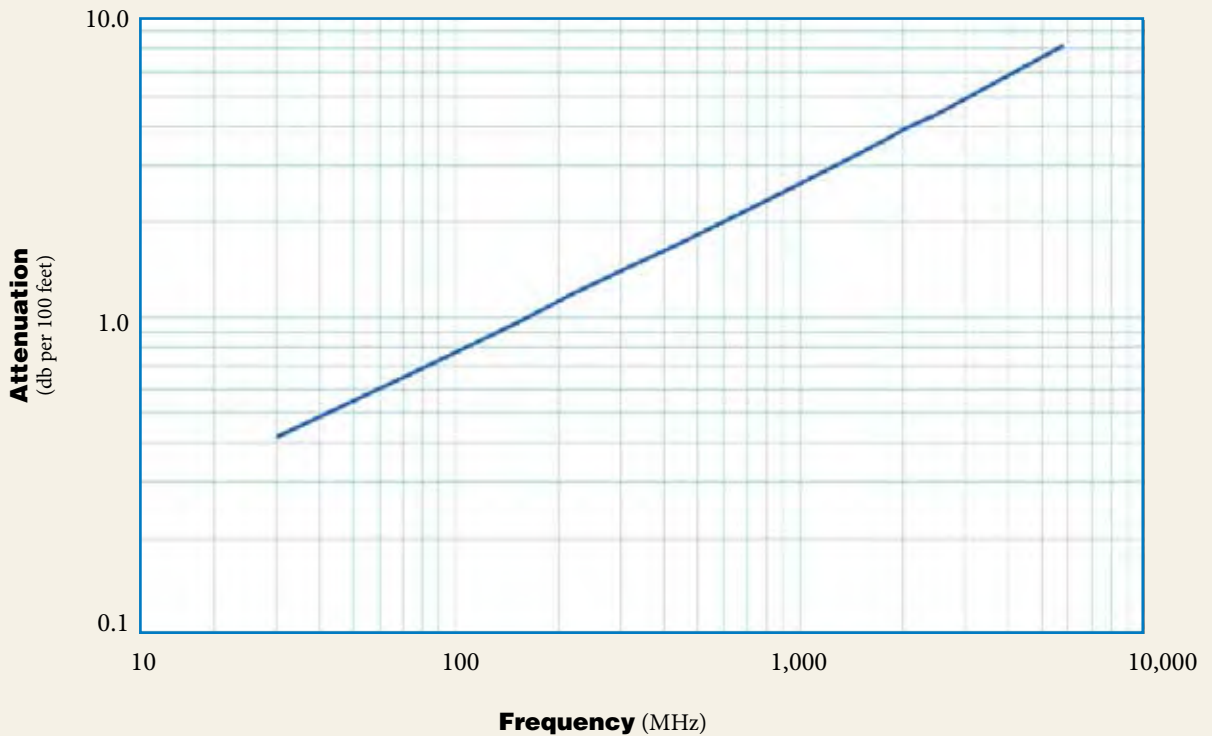

Frequency (MHz)	30	50	150	220	450	900	1500	1800	2000	2500	5800	8000
Attenuation dB/100 ft	0.4	0.5	1.0	1.2	1.7	2.5	3.3	3.7	3.9	4.4	7.3	8.8
Attenuation dB/100 m	1.4	1.8	3.2	3.9	5.6	8.2	10.9	12.1	12.8	14.5	23.8	29.0
Avg. Power kW	5.51	4.24	2.41	1.97	1.35	0.93	0.70	0.63	0.59	0.52	0.32	0.26

Calculate Attenuation =  $(0.075550) \cdot \sqrt{\text{FMHz}} + (0.000260) \cdot \text{FMHz}$  (interactive calculator available at [http://www.timesmicrowave.com/cable\\_calculators](http://www.timesmicrowave.com/cable_calculators))

Attenuation:

VSWR=1.0; Ambient = +25°C (77°F)

Power:

VSWR=1.0; Ambient = +40°C; Inner Conductor = 100°C (212°F); Sea Level; dry air; atmospheric pressure; no solar loading

# LMR®-600 Flexible Low Loss Communications Coax



Connectors			Part	Stock	VSWR**	Coupling	Inner Contact	Outer Contact	Finish*	Length	Width	Weight
Interface	Description	Number	Code	Code	Freq. (GHz)	Nut	Attach	Attach	/Pin	in (mm)	in (mm)	lb (g)
1. 7/8 EIA	Flange	EZ-600-78EIA	3190-1373	3190-1373	<1.25:1 (2.5)	NA	Spring Finger	Finger Clamp	S/S	2.3 (58)	2.60 (66.0)	0.873 (396.0)
2. 7-16 DIN Female	Straight Jack	TC-600-716FC	3190-375	3190-375	<1.25:1 (2.5)	NA	Solder	Clamp	S/S	1.1 (28)	1.00 (25.4)	0.249 (112.9)
3. 7-16 DIN	Straight Plug	EZ-600-716M-X	3190-2643	3190-2643	<1.30:1 (6)	Hex	Spring Finger	Crimp	A/S	1.6 (42)	1.38 (35.0)	0.209 (94.8)
4. 7-16 DIN	Straight Plug	TC-600-716M-X	3190-2642	3190-2642	<1.30:1 (6)	Hex	Solder	Crimp	A/S	1.6 (40)	1.38 (35.0)	0.191 (86.6)
5. 7-16 DIN	Straight Plug	TC-600-716MC	3190-502	3190-502	<1.25:1 (2.5)	Hex	Solder	Clamp	S/S	2.0 (51)	1.30 (33.0)	0.347 (157.4)
6. 7/16 Male	Right Angle	EZ-600-716M-RA-X	3190-2546	3190-2546	<1.35:1 (6)	Hex	Spring Finger	Crimp	A/G	1.6 (40)	1.38 (35.0)	0.462 (210.0)
7. 7-16 DIN	Right Angle	TC-600-716M-RA-D	3190-2599	3190-2599	<1.35:1 (6)	Hex	Solder	Crimp	A/S	1.7 (44)	2.00 (50.9)	0.362 (164.2)
8. 7-16 DIN	Straight Jack	EZ-600-716F	3190-2447	3190-2447	<1.25:1 (6)	Hex	Spring Finger	Crimp	A/G	1.8 (45)	1.32 (33.6)	0.158 (71.7)
9. HN Male	Straight Plug	TC-600-HNMC	3190-1429	3190-1429	<1.25:1 (<1)	Knurl	Solder	Clamp	S/g	2.3 (59.2)	0.88 (22.4)	0.25 (113)
10. LC Male	Straight Plug	TC-600-LCM	3190-1406	3190-1406	<1.25:1 (<1)	Hex	Solder	Clamp	N/S	3.1 (78.0)	1.62 (41.1)	1.20 (544)
11. N Female	Straight Jack	TC-600-NF-X	3190-2816	3190-2816	<1.30:1 (6)	NA	Solder	Crimp	A/G	1.7 (43)	0.69 (17.6)	0.076 (34.6)
12. N Female	Straight Jack	EZ-600-NF-X	3190-2817	3190-2817	<1.30:1 (6)	NA	Spring Finger	Crimp	A/G	1.7 (43)	0.69 (17.6)	0.090 (40.6)
13. N Female	Bulkhead Jack	EZ-600-NF-BH	3190-616	3190-616	<1.25:1 (2.5)	NA	Spring Finger	Crimp	S/G	2.4 (61)	0.88 (22.4)	0.195 (88.5)
14. N Female	Bulkhead Jack	TC-600-NF-BH	3190-589	3190-589	<1.25:1 (2.5)	NA	Solder	Crimp	S/G	2.4 (61)	0.88 (22.4)	0.195 (88.5)
15. N Female	Bulkhead Jack	TC-600-NFC-BH	3190-466	3190-466	<1.25:1 (2.5)	NA	Solder	Clamp	S/G	2.2 (56)	0.94 (23.9)	0.214 (97.1)
16. N Male	Straight Plug	EZ-600-NMK	3190-669	3190-669	<1.25:1 (2.5)	Knurl	Spring Finger	Crimp	S/G	2.1 (53)	0.92 (23.4)	0.164 (74.4)
17. N Male	Straight Plug	EZ-600-NMC-2-D	3190-2641	3190-2641	<1.25:1 (6)	Hex/Knurl	Spring Finger	Clamp	A/G	2.1 (53)	0.92 (23.4)	0.202 (91.6)
18. N Male	Straight Plug	EZ-600-NMH-X	3190-2627	3190-2627	<1.25:1 (8)	Hex/Knurl	Spring Finger	Crimp	A/G	2.1 (53)	0.92 (23.4)	0.164 (74.4)
19. N Male	Straight Plug	TC-600-NMH-X	3190-2628	3190-2628	<1.25:1 (8)	Hex/Knurl	Solder	Crimp	A/G	2.1 (53)	0.92 (23.4)	0.166 (75.3)
20. N Male	Right Angle	EZ-600-NMH-RA-X	3190-2639	3190-2639	<1.35:1 (6)	Hex	Spring Finger	Crimp	A/G	2.0 (50)	1.42 (36.0)	0.224 (101.7)
21. N Male	Right Angle	TC-600-NMH-RA-D	3190-2427	3190-2427	<1.35:1 (6)	Hex	Solder	Crimp	A/G	1.8 (46.5)	1.62 (41.2)	0.185 (84.3)
22. N Male	Straight Plug	TC-600-NMH-75-50	3190-1610	3190-1610	<1.35:1 (6)	Hex	Solder	Crimp	N/G	2.1 (52.8)	0.91 (23.1)	0.130 (59.0)
23. BNC Male	Right Angle	TC-600-BM-RA	3190-2734	3190-2734	1.30:1 (4)	Knurl	Solder	Crimp	A/G	1.8 (45.5)	1.54 (39.0)	0.164 (74.3)
24. TNC Male	Straight Plug	TC-600-TM-X	3190-2530	3190-2530	<1.25:1 (6)	Hex/Knurl	Solder	Crimp	A/G	2.3 (57.6)	0.75 (19.0)	0.100 (45.6)
25. TNC Male	Straight Plug	EZ-600-TM-X	3190-2531	3190-2531	<1.25:1 (6)	Hex/Knurl	Spring Finger	Crimp	A/G	2.3 (57.6)	0.75 (19.0)	0.100 (45.6)
26. TNC Male	Reverse Polarity	EZ-600-TM-RP	3190-796	3190-796	<1.25:1 (2.5)	Knurl	Spring Finger	Crimp	A/G	2.2 (56)	0.87 (22.0)	0.112 (50.8)
27. TNC Male	Reverse Polarity	TC-600-TM-RP	3190-1064	3190-1064	<1.25:1 (6)	Knurl	Solder	Crimp	N/G	2.1 (53.3)	0.88 (22.4)	0.112 (50.8)
28. TNC Male	Right Angle	TC-600-TM-RA-D	3190-2707	3190-2707	<1.35:1 (6)	Hex/Knurl	Solder	Crimp	A/G	1.6 (41)	1.75 (44.5)	0.164 (74.3)
29. TNC Female	Reverse Polarity	EZ-600-TF-RP	3190-797	3190-797	<1.25:1 (2.5)	NA	Spring Finger	Crimp	A/G	2.3 (58)	0.87 (22.0)	0.100 (45.4)
30. TNC Female	Reverse Polarity	TC-600-TF-RP	3190-1065	3190-1065	<1.35:1 (6)	Knurl	Solder	Crimp	N/G	2.2 (55.8)	0.68 (17.3)	0.100 (45.4)
31. UHF Male	Straight Plug	EZ-600-UM	3190-615	3190-615	<1.25:1 (2.5)	Knurl	Spring Finger	Crimp	S/G	1.7 (43)	0.88 (22.4)	0.164 (74.4)
32. UHF Male	Straight Plug	TC-600-UMC	3190-213	3190-213	<1.25:1 (2.5)	Knurl	Solder	Clamp	S/G	1.7 (43)	0.88 (22.4)	0.198 (89.8)

Finish metals: N=Nickel, S=Silver, G=Gold, SS=Stainless Steel, A=Alballoy \*\*VSWR spec based on 3 foot cable with a connector pair \*Available in bulk pack



Type	Part Number	Stock Code	Description
Crimp Tool	CT-U	3192-181	Crimp Handle
Crimp Dies	Y1720	3190-203	.610" Hex Dies
Crimp Rings	CR-600	3190-831	Crimp Rings for TC/EZ-600 connectors (pkg of 10)
Strip Tool	CST-600	3192-052	Combination prep tool for LMR-600 crimp and clamp style connectors
Crimp Tool	CT-600	3192-170	Crimp tool for LMR 600 connectors
Replacement Blades	RB-456	3190-421	Replacement Blades for Strip Tools
Deburr Tool	DBT-U	3192-001	Removes center conductor rough edges
Midspan Strip Tool	GST-600A	3190-1051	For ground strap attachment
Wrench	WR-600	3190-1435	15/16" Box Wrench (2 required for EZ-600-NMC-2)
Cutting Tool	CCT-02	3192-165	Cable end flush cut tool
Replacement Blade	RB-02	3192-166	Replacement blade for cutting tool
Replacement Blade Kit	RB-CST	3192-086	Replacement blade kit for all CST strip tools
Tool Kit	TK-600EZ	3190-1602	Tool kit for LMR crimp/clamp connectors (includes CCT-02, CST-600, CT-600, Tool Pouch)



Type	Part Number	Stock Code	Description
Ground Kit	GK-S600TT	GK-S600TT	Standard Grounding Kit (each)
Hoisting Grip	HG-600T	HG-600T	Split/Laced Type (each)
Cold Shrink	CS-A600T	CS-A600T	Cable to Antenna Junction (each)
Cold Shrink	CS-60120T	CS-60120T	LMR-600 to -1200 Junction (each)
Cold Shrink	CS-60170T	CS-60170T	LMR-600 to -1700 Junction (each)
Hanger Blocks	CB-600T	CB-600T	Dual Cable Support Block (kit of 10)
Stand. Entry Port Cushion		SC-600T-3	Three cables (each)
Snap-In Hangers	SH-U600T	SH-U600T	Snap-In Hangers (Kit of 10)
Hanger Block Supporting Hardware			Complete Range of Supporting Hardware & Adapters Available
Weather Proof Boot	IPB-600-NM	3109-600-NM	LMR-600 Male IP boot suitable for type N, TNC, BNC, 4310, 4195
Weather Proof Boot	IPB-600-NF	3109-600-NF	LMR-600 Female IP boot suitable for type N, TNC, BNC, 4310, 4195
Weather seal boots	WSB-600	3109-401	Weather seal strain relief boot (10 pk) for use with most popular LMR-600-X series connectors

# LMR<sup>®</sup>-900 Flexible Low Loss Communications Coax

## Ideal for...

- Medium Antenna Feeder runs (no jumpers required)
- Jumper Assemblies for 1-5/8" & 2-1/4" Feeders
- Any application (e.g. WLL, GPS, LMR, WLAN, WISP, WiMax, SCADA, Mobile Antennas) requiring an easily routed, low loss RF cable



Part Description				Stock
Part Number	Application	Jacket	Color	Code
LMR-900-DB	Outdoor/Watertight	PE	Black	54094
LMR-900-FR	Indoor/Outdoor Riser CMR	FRPE	Black	54033

PVC: Poly Vinyl Chloride

Mechanical Specifications			
Performance Property	Units	US	(metric)
Bend Radius: installation	in. (mm)	3.00	(76.2)
Bend Radius: repeated	in. (mm)	9.0	(228.6)
Bending Moment	ft-lb (N-m)	9.0	(12.20)
Weight	lb/ft (kg/m)	0.266	(0.40)
Tensile Strength	lb (kg)	750	(340.5)
Flat Plate Crush	lb/in. (kg/mm)	100	(1.79)

Construction Specifications		
Description	Material	In. (mm)
Inner Conductor	BC Tube (.222" ID)	0.262 (6.65)
Dielectric	Foam PE	0.680 (17.27)
Outer Conductor	Aluminum Tape	0.686 (17.42)
Overall Braid	Tinned Copper	0.732 (18.59)
Jacket	(see table)	0.870 (22.10)

Environmental Specifications		
Performance Property	°F	°C
Installation Temperature Range	-40/+185	-40/+85
Storage Temperature Range	-94/+185	-70/+85
Operating Temperature Range	-40/+185	-40/+85

Electrical Specifications			
Performance Property	Units	US	(metric)
Velocity of Propagation	%	87	
Dielectric Constant	NA	1.32	
Time Delay	nS/ft (nS/m)	1.17	(3.83)
Impedance	ohms	50	
Capacitance	pF/ft (pF/m)	23.4	(76.6)
Inductance	uH/ft (uH/m)	0.058	(0.19)
Shielding Effectiveness	dB	>90	
DC Resistance			
Inner Conductor	ohms/1000ft (/km)	0.54	(1.77)
Outer Conductor	ohms/1000ft (/km)	0.55	(1.8)
Voltage Withstand	Volts DC	5000	
Jacket Spark	Volts RMS	8000	
Peak Power	kW	62	

ES MICROWAVE

Attenuation vs. Frequency (typical)

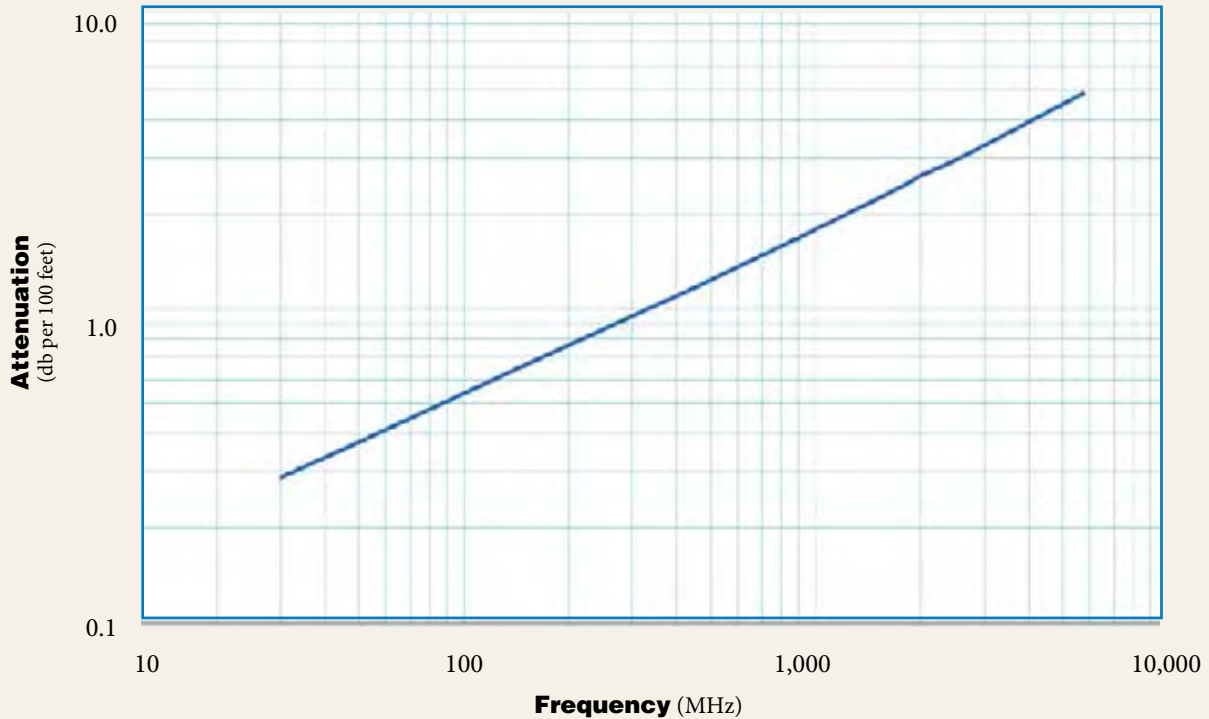

Frequency (MHz)	30	50	150	220	450	900	1500	1800	2000	2500	5800
Attenuation dB/100 ft	0.3	0.4	0.7	0.8	1.2	1.7	2.2	2.5	2.6	3.0	4.9
Attenuation dB/100 m	0.9	1.2	2.2	2.6	3.8	5.6	7.4	8.2	8.6	9.8	16.0
Avg. Power kW	8.89	6.85	3.89	3.19	2.19	1.51	1.14	1.03	0.97	0.86	0.52

Calculate Attenuation =  $(0.051770) \cdot \sqrt{FMHz} + (0.000160) \cdot FMHz$  (interactive calculator available at [http://www.timesmicrowave.com/cable\\_calculators](http://www.timesmicrowave.com/cable_calculators))

Attenuation:  
VSWR=1.0 ; Ambient = +25°C (77°F)

Power:  
VSWR=1.0; Ambient = +40°C; Inner Conductor = 100°C (212°F); Sea Level; dry air; atmospheric pressure; no solar loading

# LMR<sup>®</sup>-900 Flexible Low Loss Communications Coax



Connectors		Part Number	Stock Code	VSWR	**Coupling	Inner Contact	Outer Contact	Finish*	Length	Width	Weight
Interface	Description			Freq. (GHz)	Nut	Attach	Attach	/Pin	(mm)	(mm)	(lb (g))
1. 7-16 DIN Female	Straight Jack	EZ-900-716FC-2	3190-1550	<1.25:1	(2.5) NA	Press Fit	Clamp	S/S	2.0 (51)	1.38 (35.1)	0.379 (171.9)
2. 7-16 DIN Male	Straight Plug	EZ-900-716MC-2	3190-1641	<1.25:1	(2.5) Hex	Press Fit	Clamp	S/S	2.0 (51)	1.44 (36.6)	0.485 (220.0)
3. 7-16 DIN Male	Right Angle	EZ-900-716-MC-RA	3190-614	<1.35:1	(2.5) Hex	Press Fit	Clamp	S/S	2.7 (69)	2.15 (55.0)	1.150 (521.6)
4. 7/8 EIA Male	Straight Plug	EZ-900-78EIA-2	3190-1282	<1.25:1	(2.5) NA	Press Fit	Clamp	S/S	3.0 (76)	2.24 (56.9)	1.013 (459.5)
5. 7/8 EIA Male	Right Angle	EZ-900-78EIA-RA	3190-1450	<1.25:1	(1) Flange	Press Fit	Clamp	S/S	2.95 (75.0)	2.60 (66.0)	1.50 (680.4)
6. N Female	Straight Jack	EZ-900-NFC-2	3190-1263	<1.25:1	(6) NA	Press Fit	Clamp	S/S	2.0 (51)	1.38 (35.1)	0.443 (200.9)
7. N Male	Straight Plug	EZ-900-NMC-2	3190-1262	<1.25:1	(6) Hex/Knurl	Press Fit	Clamp	S/S	2.0 (51)	1.38 (35.1)	0.463 (210.0)

\* Finish metals: N=Nickel, S=Silver, G=Gold, SS=Stainless Steel, A=Alballoy \*\*VSWR spec based on 3 foot cable with a connector pair



## Install Tools

Type	Part Number	Stock Code	Description
Strip Tool	ST-900C	3190-1310	For LMR 900 Clamp Style Connectors
Midspan Strip Tool	GST-900A	3190-435	For Ground Strap Attachment
Wrenches	WR-900	3190-509	1-1/4" Box Wrench (2 required)
Cutting Tool	CCT-02	3192-165	Cable end flush cut tool
Replacement Blade	RB-02	3192-166	Replacement blade for cutting tool

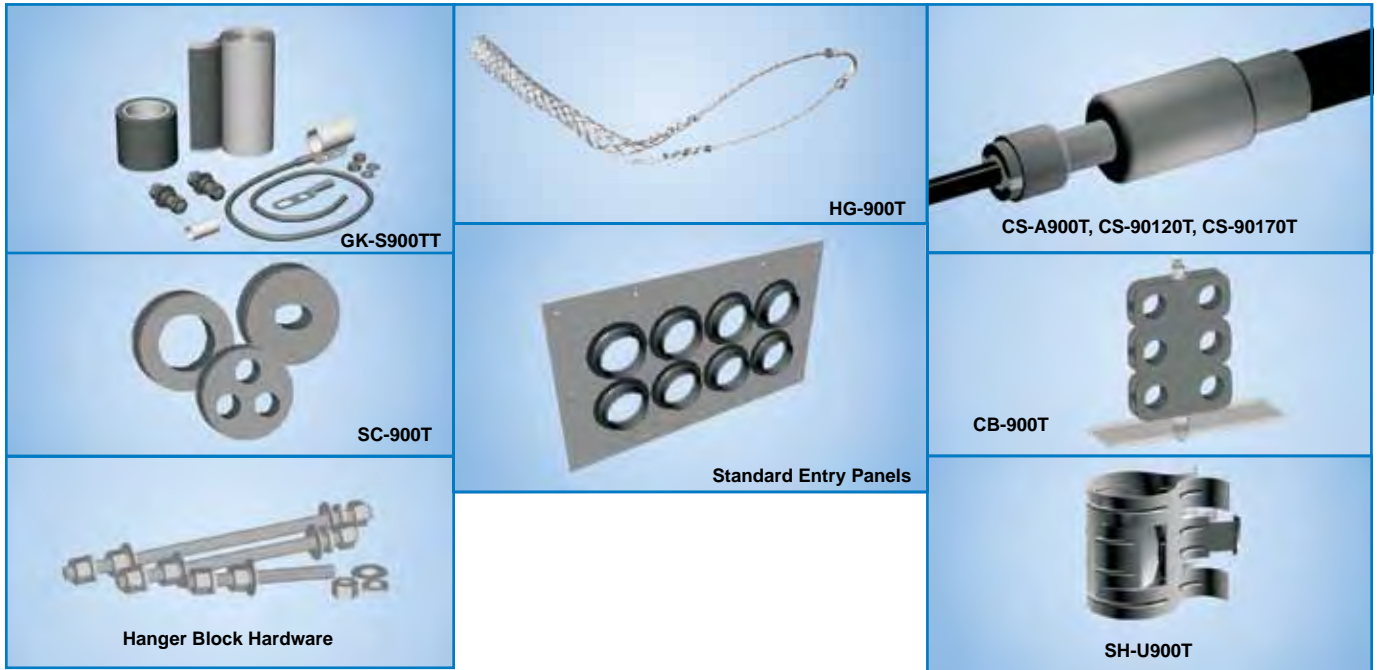

## Accessories

Type	Part Number	Stock Code	Description
Ground Kit	GK-S900TT	GK-S900TT	Standard Grounding Kit (each)
Hoisting Grip	HG-900T	HG-900T	Split/Laced Type (each)
Cold Shrink	CS-A900T	CS-A900T	Cable to Antenna Junction (each)
Cold Shrink	CS-90120T	CS-90120T	LMR-900 to -1200 Junction (each)
Cold Shrink	CS-90170T	CS-90170T	LMR-900 to -1700 Junction (each)
Stand. Entry Port Cushion	SC-900T-3	SC-900T-3	Three Cables (each)
Standard Entry Panels			Full Range of Port Styles/Combinations Available
Hanger Blocks	CB-900T	CB-900T	Dual Cable Support Block (kit of 10)
Hanger Block Supporting Hardware			Complete Range of Supporting Hardware & Adapters Available
Snap-in Hangers	SH-U900T	SH-U900T	Snap-in Hanger (Kit of 10)

# LMR<sup>®</sup>-1200 Flexible Low Loss Communications Coax

## Ideal for...

- Medium Antenna Feeder runs
- Jumper Assemblies for 1-5/8" & 2-1/4" Feeders
- Building-Top Sites
- Any application (e.g. WLL, GPS, LMR, WLAN, WISP, WiMax, SCADA, Mobile Antennas) requiring an easily routed, low loss RF cable



Part Description				Stock
Part Number	Application	Jacket Color		Code
LMR-1200-DB	Outdoor/Watertight	PE	Black	54095
LMR-1200-FR	Indoor/Outdoor Riser CMR	FRPE	Black	54034

Construction Specifications			
Description	Material	In.	(mm)
Inner Conductor	BC Tube (.309" ID)	0.349	(8.86)
Dielectric	Foam PE	0.920	(23.37)
Outer Conductor	Aluminum Tape	0.926	(23.52)
Overall Braid	Tinned Copper	0.972	(24.69)
Jacket	(see table)	1.200	(30.48)

Mechanical Specifications			
Performance Property	Units	US	(metric)
Bend Radius: installation	in. (mm)	6.50	(165.1)
Bend Radius: repeated	in. (mm)	12.0	(304.8)
Bending Moment	ft-lb (N-m)	15	(20.34)
Weight	lb/ft (kg/m)	0.448	(0.67)
Tensile Strength	lb (kg)	1300	(590.2)
Flat Plate Crush	lb/in. (kg/mm)	250	(4.47)

Environmental Specifications		
Performance Property	°F	°C
Installation Temperature Range	-40/+185	-40/+85
Storage Temperature Range	-94/+185	-70/+85
Operating Temperature Range	-40/+185	-40/+85

Electrical Specifications			
Performance Property	Units	US	(metric)
Velocity of Propagation	%	88	
Dielectric Constant	NA	1.29	
Time Delay	nS/ft (nS/m)	1.15	(3.79)
Impedance	ohms	50	
Capacitance	pF/ft (pF/m)	23.1	(75.8)
Inductance	uH/ft (uH/m)	0.058	(0.19)
Shielding Effectiveness	dB	>90	
DC Resistance			
Inner Conductor	ohms/1000ft (/km)	0.32	(1.0)
Outer Conductor	ohms/1000ft (/km)	0.37	(1.2)
Voltage Withstand	Volts DC	6000	
Jacket Spark	Volts RMS	8000	
Peak Power	kW	90	



Attenuation vs. Frequency (typical)

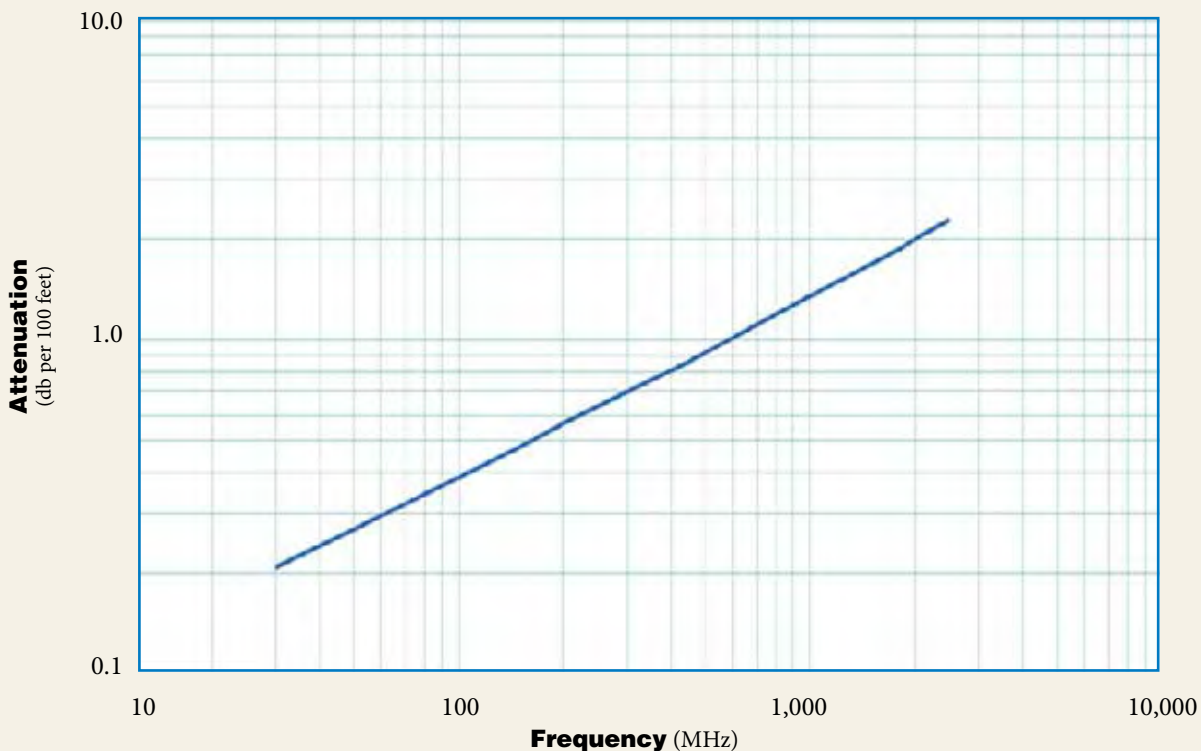

Frequency (MHz)	30	50	150	220	450	900	1500	1800	2000	2500
Attenuation dB/100 ft	0.2	0.3	0.5	0.6	0.9	1.3	1.7	1.9	2.0	2.3
Attenuation dB/100 m	0.7	0.9	1.6	1.9	2.8	4.2	5.5	6.1	6.5	7.4
Avg. Power kW	12.63	9.72	5.54	4.49	3.06	2.09	1.57	1.41	1.33	1.16

Calculate Attenuation =  
 $(0.037370) \cdot \sqrt{\text{FMHz}} + (0.000160) \cdot \text{FMHz}$  (interactive calculator available at [http://www.timesmicrowave.com/cable\\_calculators](http://www.timesmicrowave.com/cable_calculators))  
 Attenuation:  
 VSWR=1.0 ; Ambient = +25°C (77°F)  
 Power:  
 VSWR=1.0; Ambient = +40°C; Inner Conductor = 100°C (212°F); Sea Level; dry air; atmospheric pressure; no solar loading

# LMR<sup>®</sup>-1200 Flexible Low Loss Communications Coax

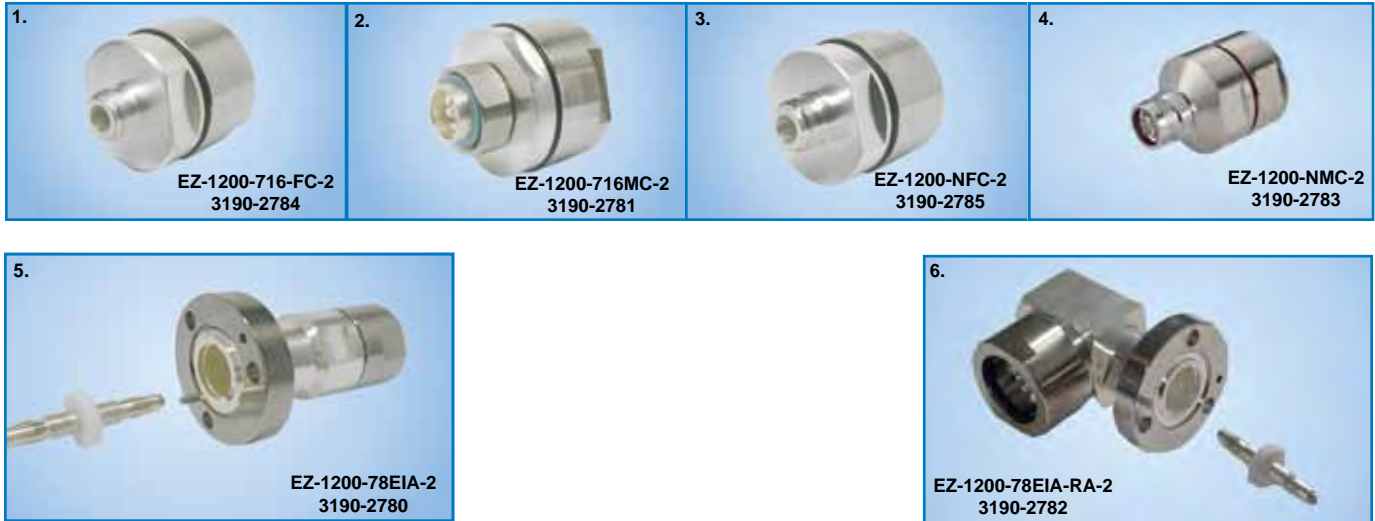

Connectors		Part Number	Stock Code	VSWR**	Coupling Nut	Inner Contact Attach	Outer Contact Attach	Finish* /Pin	Length in (mm)	Width in (mm)	Weight lb (g)
1.	7-16 DIN Female Straight Jack	EZ-1200-716FC-2	3190-2784	<1.20:1 (2.5)	NA	Spring Finger	Clamp	A/S	2.3 (58)	1.73 (44.0)	0.586 -(265.8)
2.	7-16 DIN Male Straight Plug	EZ-1200-716MC-2	3190-2781	<1.20:1 (2.5)	Hex	Spring Finger	Clamp	A/S	2.3 (58)	1.73 (44.0)	0.848 (384.6)
3.	N Female Straight Jack	EZ-1200-NFC-2	3190-2785	<1.20:1 (2.5)	NA	Spring Finger	Clamp	A/S	2.2 (51)	1.73 (44.0)	0.630 (285.9)
4.	N Male Straight Plug	EZ-1200-NMC-2	3190-2783	<1.20:1 (2.5)	Hex/Knurl	Spring Finger	Clamp	A/S	2.4 (61)	1.73 (44.0)	0.651 (295.3)
5.	7/8 EIA Straight Plug	EZ-1200-78EIA-2	3190-2780	<1.15:1 (0.5)	NA	Spring Finger	Clamp	A/S	3.8 (96)	2.22 (56.5)	1.206 (547.0)
6.	7/8 EIA Right Angle	EZ-1200-78EIA-RA-2	3190-2782	<1.15:1 (0.5)	NA	Spring Finger	Clamp	A/S	3.1 (80)	3.07 (78.1)	1.800 (816.5)

\* Finishes: N=Nickel, S=Silver, G=Gold, SS=Stainless Steel, A=Alballoy \*\*VSWR spec based on 3 foot cable with a connector pair



## Install Tools

Type	Part Number	Stock Code	Description
Midspan Strip Tool	GST-1200A	3190-436	For Ground Strap Attachment
Wrench	WR-1200A	3190-512	1-9/16" Box Wrench (1 required)
Wrench	WR-1200B	3190-511	1-7/16" Box Wrench (1 required)
Strip Tool	ST-1200-CH	3192-124	For LMR-1200 clamp style connectors
Cutting Tool	CCT-02	3192-165	Cable end flush cut tool
Replacement Blade	RB-02	3192-166	Replacement blade for cutting tool



## Hardware Accessories

Type	Part Number	Stock Code	Description
Ground Kit	GK-S1200TT	GK-S1200TT	Standard Grounding Kit (each)
Hoisting Grip	HG-1200T	HG-1200T	Split/Laced Type (each)
Cold Shrink	CS-90120T	CS-90120T	LMR-900 to -1200 Junction (each)
Cold Shrink	CS-60120T	CS-60120T	LMR-600 to -1200 Junction (each)
Standard Entry Port Cushion	SC-1200T	SC-1200T	Three Cables (each)
Standard Entry Panels	Full Range of Port Styles/Combinations Available		
Hanger Blocks	CB-1200T	CB-1200T	Dual Cable Support Block (kit of 10)
Hanger Block Supporting Hardware	Complete Range of Supporting Hardware & Adapters Available		
Snap-In Hangers	SH-U1200T	SH-U1200T	Snap-In Hangers (Kit of 10)

# LMR<sup>®</sup>-1700 Flexible Low Loss Communications Coax

Ideal for...

- Long Antenna Feeder runs
- Building-Top Sites
- Any application (e.g. WLL, GPS, LMR, WLAN, WISP, WiMax, SCADA, Mobile Antennas) requiring an easily routed, low loss RF cable



Part Description				
Part Number	Application	Jacket Color	Color	Stock Code
LMR-1700-DB	Outdoor/Watertight	PE	Black	54096
LMR-1700-FR	Indoor/Outdoor Riser CMR	FRPE	Black	54035

Construction Specifications			
Description	Material	In.	(mm)
Inner Conductor	BC Tube (.477" ID)	0.527	(13.39)
Dielectric	Foam PE	1.350	(34.29)
Outer Conductor	Aluminum Tape	1.356	(34.44)
Overall Braid	Tinned Copper	1.402	(35.61)
Jacket	(see table)	1.670	(42.42)

Mechanical Specifications			
Performance Property	Units	US	(metric)
Bend Radius: installation	in. (mm)	13.50	(342.9)
Bend Radius: repeated	in. (mm)	17.0	(431.8)
Bending Moment	ft-lb (N-m)	40	(54.23)
Weight	lb/ft (kg/m)	0.736	(1.10)
Tensile Strength	lb (kg)	1500	(681.0)
Flat Plate Crush	lb/in. (kg/mm)	300	(5.36)

Environmental Specifications		
Performance Property	°F	°C
Installation Temperature Range	-40/+185	-40/+85
Storage Temperature Range	-94/+185	-70/+85
Operating Temperature Range	-40/+185	-40/+85

Electrical Specifications			
Performance Property	Units	US	(metric)
Velocity of Propagation	%	89	
Dielectric Constant	NA	1.26	
Time Delay	nS/ft (nS/m)	1.14	(3.75)
Impedance	ohms	50	
Capacitance	pF/ft (pF/m)	22.8	(74.9)
Inductance	uH/ft (uH/m)	0.057	(0.19)
Shielding Effectiveness	dB	>90	
DC Resistance			
Inner Conductor	ohms/1000ft (/km)	0.21	(0.7)
Outer Conductor	ohms/1000ft (/km)	0.27	(0.9)
Voltage Withstand	Volts DC	9000	
Jacket Spark	Volts RMS	8000	
Peak Power	kW	202	

Attenuation vs. Frequency (typical)

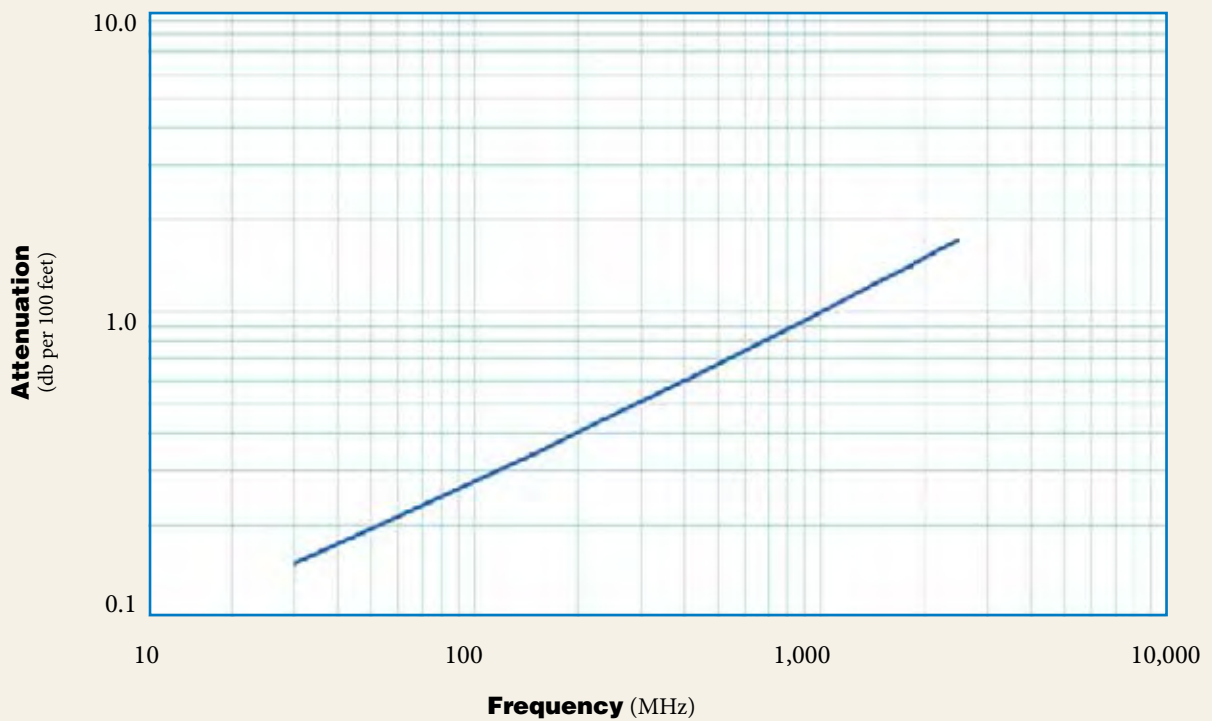

Frequency (MHz)	30	50	150	220	450	900	1500	1800	2000	2500
Attenuation dB/100 ft	0.1	0.2	0.3	0.4	0.6	0.9	1.3	1.4	1.5	1.7
Attenuation dB/100 m	0.5	0.6	1.1	1.4	2.1	3.1	4.1	4.6	4.9	5.7
Avg. Power kW	20.27	15.55	8.72	7.09	4.79	3.23	2.40	2.15	2.02	1.76

Calculate Attenuation =  $(0.026460) \cdot \sqrt{\text{FMHz}} + (0.000160) \cdot \text{FMHz}$  (interactive calculator available at [http://www.timesmicrowave.com/cable\\_calculators](http://www.timesmicrowave.com/cable_calculators))

Attenuation:

VSWR=1.0; Ambient = +25°C (77°F)

Power:

VSWR=1.0; Ambient = +40°C; Inner Conductor = 100°C (212°F); Sea Level; dry air; atmospheric pressure; no solar loading

# LMR<sup>®</sup>-1700 Flexible Low Loss Communications Coax

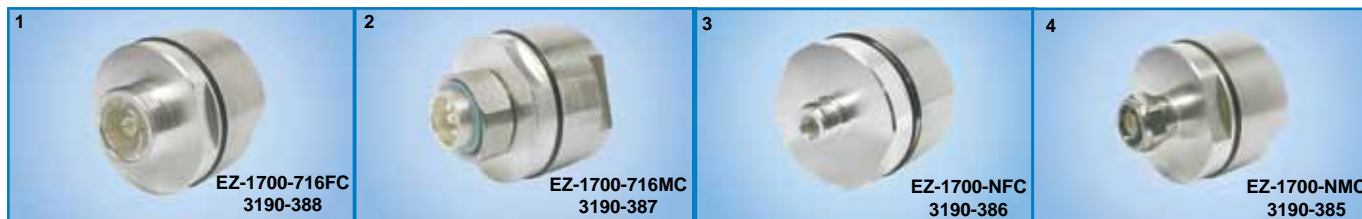

## Connectors

Interface	Description	Part Number	Stock Code	VSWR** Freq. (GHz)	Coupling Nut	Inner Contact Attach	Outer Contact Attach	Finish* Body /Pin	Length in (mm)	Width in (mm)	Weight lb (g)
1. 7-16 DIN Female	Straight Jack	EZ-1700-716FC	3190-388	<1.25:1 (2.5)	NA	Press Fit	Clamp	S/S	2.17 (55)	2.2 (55.9)	1.005(455.9)
2. 7-16 DIN Male	Straight Plug	EZ-1700-716MC	3190-387	<1.25:1 (2.5)	Hex	Press Fit	Clamp	S/S	2.17 (55)	2.2 (55.9)	1.055(478.5)
3. N Female	Straight Jack	EZ-1700-NFC	3190-386	<1.25:1 (2.5)	NA	Press Fit	Clamp	S/S	2.17 (55)	2.2 (55.9)	1.087(493.1)
4. N Male	Straight Plug	EZ-1700-NMC	3190-385	<1.25:1 (2.5)	Hex	Press Fit	Clamp	S/S	2.17 (55)	2.2 (55.9)	1.058(479.9)

\* Finishes: N=Nickel, S=Silver, G=Gold, SS=Stainless Steel, A=Albally **\*\*VSWR spec based on 3 foot cable with a connector pair**



## Install Tools

Type	Part Number	Stock Code	Description
Strip Tool	ST-1700C	3190-312	For Clamp Style Connectors
Midspan Strip Tool	GST-1700A	3190-437	For Ground Strap Attachment
Wrenches	WR-1700	3190-514	2" Box Wrench (2 required)
Cutting Tool	CCT-02	3192-165	Cable end flush cut tool
Replacement Blade	RB-02	3192-166	Replacement blade for cutting tool



## Hardware Accessories

Type	Part Number	Stock Code	Description
Ground Kit	GK-S1700TT	GK-S1700TT	Standard Grounding Kit (each)
Hoisting Grip	HG-1700T	HG-1700T	Split/Laced Type (each)
Cold Shrink	CS-90170T	CS-90170T	LMR-900 to -1700 Junction (each)
Cold Shrink	CS-60170T	CS-60170T	LMR-600 to -1700 Junction (each)
Standard Entry Port Cushion	SC-1700T	SC-1700T	One Cable (each)
Standard Entry Panels	Full Range of Port Styles/Combinations Available		
Hanger Blocks	CB-1700T	CB-1700T	Dual Cable Support Block (kit of 10)
Hanger Block Supporting Hardware	Complete Range of Supporting Hardware & Adapters Available		
Snap-In Hangers	SH-U1700T	SH-U1700T	Snap-In Hangers (Kit of 10)

MES MICROWAVE

Attenuation vs. Frequency (typical)

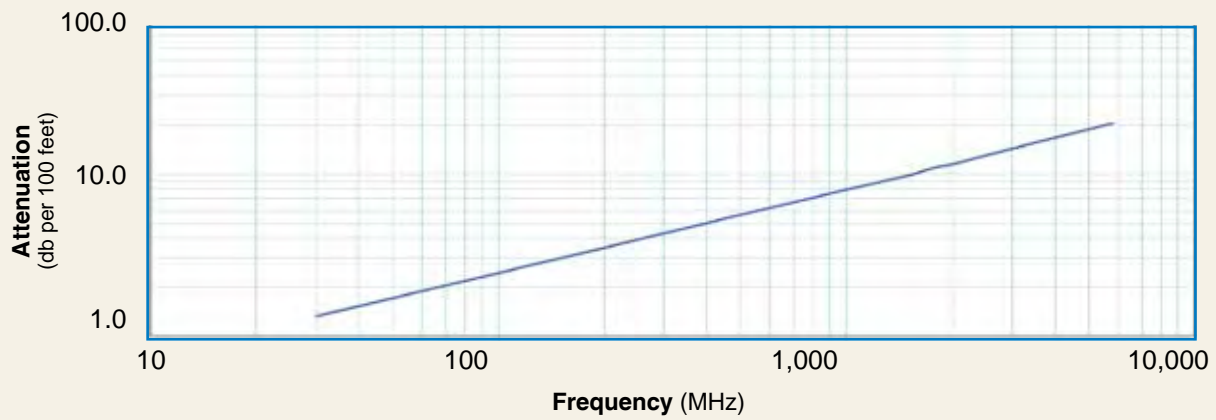

Frequency (MHz)	30	50	150	220	450	900	1500	1800	2000	2500	5800	8000
<b>Attenuation dB/100 ft</b>	1.3	1.7	3.0	3.7	5.3	7.6	9.9	10.9	11.5	12.9	20.4	24.3
<b>Attenuation dB/100 m</b>	4.4	5.7	9.9	12.0	17.3	24.8	32.4	35.6	37.7	42.4	66.8	79.7
<b>Avg. Power kW</b>	1.49	1.15	0.66	0.54	0.38	0.26	0.20	0.18	0.17	0.15	0.10	0.08

**Calculate Attenuation =**

$(0.242080) \cdot \sqrt{\text{FMHz}} + (0.000330) \cdot \text{FMHz}$  (interactive calculator available at [http://www.timesmicrowave.com/cable\\_calculators](http://www.timesmicrowave.com/cable_calculators))

**Attenuation:**

VSWR=1.0 ; Ambient = +25°C (77°F)

**Power:** VSWR=1.0; Ambient = +40°C; Inner Conductor = 100°C (212°F); Sea Level; dry air; atmospheric pressure; no solar loading



# LMR<sup>®</sup>-240 Flexible Low Loss Communications Coax



Connectors												
Interface	Description	Part Number	Stock Code	VSWR** Freq. (GHz)	Coupling Nut	Inner Contact Attach	Outer Contact Attach	Finish* Body /Pin	Length in (mm)	Width in (mm)	Weight lb (g)	
1. F Male	Straight Plug	TC-240-FM-X	3190-2891	<1.25:1 (2.5)	Knurl	Solder	Crimp	N/G	1.1 (28)	0.45 (11.4)	0.014 (6.4)	
2. N Male	Straight Plug	EZ-240-NMH-X	3190-2893	<1.25:1 (2.5)	Hex/Knurl	Spring Finger	Crimp	A/G	1.5 (38.1)	0.78 (19.8)	0.086 (39.0)	
3. N Male	Right Angle	EZ-240-NMH-RA-X	3190-6143	<1.35:1 (6)	Hex	Spring Finger	Crimp	A/G	1 (25.1)	1.04 (26.4)	0.115 (52.0)	

Connectors													
Interface	Description	Part Number	Stock Code	VSWR** Freq. (GHz)	Coupling Nut	Inner Contact Attach	Outer Contact Attach	Finish* Body /Pin	Length in (mm)	Width in (mm)	Weight lb (g)		
4. N Male	Right Angle	TC-240-NMH-RA-D	3190-2426	<1.35:1 (6)	Hex/Knurl	Solder	Crimp	A/G	1.2 (32.4)	1.22 (31.0)	0.091 (41.7)		
5. N Male	Straight Plug	TC-240-NMH-X	3190-2887*	<1.25:1 (2.5)	Hex/Knurl	Solder	Crimp	N/S	1.5 (38)	0.75 (19.1)	0.086 (39.0)		
6. N Male	Straight Plug	TC-240-NMC	3190-244	<1.25:1 (2.5)	Knurl	Solder	Clamp	S/G	1.5 (38)	0.75 (19.1)	0.082 (37.2)		
7. 1.0/2.3 DIN	Straight Plug	EZ-240-1023M	3190-6283	<1.35:1 (2.5)	knurl	Spring Finger	Crimp	N/G	1.1 (28.5)	0.33 (8.5)	0.014 (6.63)		
8. N Female	Bulkhead Jack	TC-240-NF-BH-X	3190-2888	<1.25:1 (2.5)	NA	Solder	Crimp	A/G	1.7 (44)	0.88 (22.2)	0.115 (52.2)		
9. N Female	Panel Mount	TC-240-NF-PM-X	3190-2889*	<1.25:1 (6)	NA	Solder	Crimp	A/G	1.7 (44)	0.88 (22.2)	0.115 (52.2)		
10. N Female	Straight Jack	EZ-240-NF-X	3190-2795	<1.25:1 (6)	NA	Spring Finger	Crimp	A/G	1.4 (35.4)	0.62 (15.8)	0.040 (18.0)		
11. BNC Male	Straight Plug	TC-240-BMC	3190-242	<1.25:1 (2.5)	Knurl	Solder	Clamp	S/G	1.7 (43)	0.56 (14.2)	0.040 (18.1)		
12. BNC Male	Straight Plug	EZ-240-BM-X	3190-6120	<1.25:1 2.5	Knurl	Spring Finger	Crimp	A/G	1.3 (34)	0.58 (14.7)	0.043 (19.5)		
13. BNC Male	Straight Plug	TC-240-BM-X	3190-2890	<1.25:1 (2.5)	Knurl	Solder	Crimp	A/G	1.3 (34)	0.58 (14.7)	0.043 (19.5)		
14. BNC Male	Right Angle	TC-240-BM-RA-D	3190-2869	<1.25:1 (2)	Knurl	Solder	Crimp	A/G	1.0 (25.1)	0.57 (14.5)	0.115 (52.0)		
15. BNC Male	Right Angle	EZ-240-BM-RA-X	3190-2868	<1.30:1 (4)	KNURL	Spring Finger	Crimp	A/G	1.3 (33.6)	1.19 (30.1)	0.091 (41.7)		
16. TNC Male	Straight Plug	EZ-240-TM-X	3190-2725	<1.25:1 (2.5)	Knurl	Spring Finger	Crimp	N/G	1.4 (34.3)	0.59 (15.0)	0.043 (19.5)		
17. TNC Male	Straight Plug	TC-240-TM-X	3190-2797	<1.25:1 (2.5)	Knurl	Solder	Crimp	N/G	1.7 (43)	0.59 (15.0)	0.043 (19.5)		
18. TNC Male	Reverse Polarity	EZ-240-TM-RP-X	3190-2892	<1.25:1 (6)	Knurl	Spring Finger	Crimp	A/G	1.4 (36)	0.59 (15.0)	0.043 (19.5)		
19. TNC Male	Right Angle	TC-240-TM-RA-D	3190-2798	<1.25:1 (6)	Hex	Solder	Crimp	A/G	1.0 (25.1)	0.62 (15.7)	0.115 (52.0)		
20. TNC Female	Straight Jack	EZ-240-TF-X	3190-6204	<1.25:1 (6)	NA	Spring Finger	Crimp	A/G	1.1 (27.2)	0.87 (22.0)	0.033(15.0)		
21. TNC Female	Reverse Polarity	EZ-240-TF-RP-X	3190-6167	<1.35:1 (6)	NA	Spring Finger	Crimp	A/G	1.1 (27.2)	0.87 (22.0)	0.033(15.0)		
22. QMA Male	Straight Plug	EZ-240-QM-X	3190-2894	<1.25: (6)	Knurl	Spring Finger	Crimp	N/G	1.2 (30.0)	0.41 (10.5)	0.014 (6.35)		
23. QMA Male	Right Angle	EZ-240-QM-RA-X	3190-2895	<1.25: (<6)	Knurl	Spring Finger	Crimp	N/G	0.8 (20.3)	0.65 (16.5)	0.019 (8.62)		
24. SMA Male	Straight Plug	EZ-240-SM-X	3190-2897	<1.25: (6)	Hex	Spring Finger	Crimp	N/G	1.0 (25.4)	0.32 (8.1)	0.016 (7.26)		
25. SMA Male	Straight Plug	TC-240-SM-SS-X	3190-2898*	<1.25:1 (10)	Hex	Solder	Crimp	SS/G	1.0 (25)	0.32 (8.1)	0.016 (7.3)		
26. SMA Male	Right Angle	TC-240-SM-RA-SS-X	3190-2900*	<1.35:1 (6)	Hex	Solder	Crimp	SS/G	0.8 (20)	0.65 (16.5)	0.019 (8.6)		
27. SMA Male	Right Angle	EZ-240-SM-RA-X	3190-2899	<1.25:1 (6)	Hex	Spring Finger	Crimp	A/G	0.9 (22.8)	0.31 (7.9)	0.019 (8.6)		
28. SMA Male	Reverse Polarity	TC-240-SM-RP	3190-326	<1.25:1 (2.5)	Hex	Solder	Crimp	SS/G	1.0 (25)	0.32 (8.1)	0.016 (7.3)		
29. SMA Female	Bulkhead Jack	TC-240-SF-SS-BH-X	3190-2896*	<1.25:1 (2.5)	NA	Solder	Crimp	SS/G	1.1 (29)	0.31 (7.9)	0.019 (8.6)		
30. Mini-UHF	Straight Plug	TC-240-MUHF	3190-445	<1.25:1 (2.5)	Knurl	Solder	Crimp	N/G	1.1 (28)	0.45 (11.4)	0.014 (6.4)		
31. 7/16 Din Male	Straight Plug	TC-240-716M	3190-2982	<1.35:1 (3)	Hex	Spring Finger	Crimp	A/S	2.0 (50.5)	1.26 (32.0)	0.186 (84.4)		
32. 7/16 Din Male	Right Angle	TC-240-716M-RA-D	3190-2983	<1.35:1 (3)	Hex	Solder	Crimp	A/S	1.4 (34.3)	1.60 (40.6)	0.239 (108.5)		

\*Finish metals: N=Nickel, S=Silver, G=Gold, SS=Stainless Steel, A=Alloy \*\*VSWR spec based on 3 foot cable with a connector pair \*Available in bulk pack

## Hardware Accessories

Type	Part Number	Stock Code	Description
Ground Kit	GK-S240TT	GK-S240TT	Standard Ground Kit (each)
Weatherproof Kit	WSB-240	3109-400	Weatherproof/Strain relief kit for LMR-240



WSB-240  
3109-400



GK-S240TT



CT-240/200/195/100  
3190-667



CCT-02  
3192-165



CST-240A  
3192-152



DBT-U  
3192-001



RB-CST  
3192-086

## Install Tools

Type	Part Number	Stock Code	Description
Crimp Tool	CT-240/200/195/100	3190-667	Crimp tool for LMR-100, 195, 200 and 240 connectors
Strip Tool	CST-240A	3192-152	Prep tool for LMR-240 connectors
Deburr Tool	DBT-U	3192-001	Removes center conductor rough edges
Cutting Tool	CCT-02	3192-165	Cable end flush cut tool
Replacement Blade	RB-02	3192-166	Replacement blade for cutting tool
Replacement Blade Kit	RB-CST	3192-086	Replacement blade kit for all CST strip tools

# LMR®-300 Flexible Low Loss Communications Coax

Ideal for...

- Jumper Assemblies in Wireless Communications Systems
- Short Antenna Feeder runs
- Any application (e.g. WLL, GPS, LMR, WLAN, WISP, WiMax, SCADA, Mobile Antennas) requiring an easily routed, low loss RF cable



Part Description				Stock
Part Number	Application	Jacket Color		Code
LMR-300	Outdoor	PE	Black	54086
LMR-300-DB	Outdoor/Watertight	PE	Black	54114
LMR-300-FR	Indoor/Outdoor Riser CMR	FRPE	Black	54087
LMR-300-FR-PVC	Indoor/Outdoor Riser CMR	FRPVC	Black	54108
LMR-300-PVC	General Purpose	PVC	Black	54217
LMR-300-PVC-W	General Purpose	PVC	White	54203

Construction Specifications			
Description	Material	In.	(mm)
Inner Conductor	Solid BC	0.070	(1.78)
Dielectric	Foam PE	0.190	(4.83)
Outer Conductor	Aluminum Tape	0.196	(4.98)
Overall Braid	Tinned Copper	0.225	(5.72)
Jacket	(see table)	0.300	(7.62)

Environmental Specifications			
Performance Property	'F	°C	
Installation Temperature Range	-40/+185	-40/+85	
Storage Temperature Range	-94/+185	-70/+85	
Operating Temperature Range	-40/+185	-40/+85	

Electrical Specifications			
Performance Property	Units	US	(metric)
Velocity of Propagation	%	82	
Dielectric Constant	NA	1.38	
Time Delay	nS/ft (nS/m)	1.20	(3.92)
Impedance	ohms	50	
Capacitance	pF/ft (pF/m)	23.9	(78.4)
Inductance	uH/ft (uH/m)	0.060	(0.20)
Shielding Effectiveness	dB	>90	
DC Resistance			
Inner Conductor	ohms/1000ft (/km)	2.12	(7.0)
Outer Conductor	ohms/1000ft (/km)	2.21	(7.3)
Voltage Withstand	Volts DC		2000
Jacket Spark	Volts RMS		5000
Peak Power	kW		10

Mechanical Specifications			
Performance Property	Units	US	(metric)
Bend Radius: installation	in. (mm)	0.88	(22.2)
Bend Radius: repeated	in. (mm)	3.0	(76.2)
Bending Moment	ft-lb (N-m)	0.38	(0.52)
Weight	lb/ft (kg/m)	0.055	(0.08)
Tensile Strength	lb (kg)	120	(54.5)
Flat Plate Crush	lb/in. (kg/mm)	30	(0.54)

Attenuation vs. Frequency (typical)

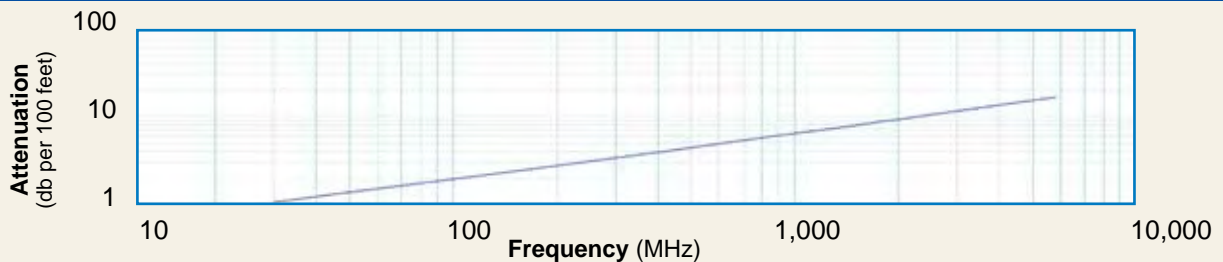

Frequency (MHz)	30	50	150	220	450	900	1500	1800	2000	2500	5800	8000
Attenuation dB/100 ft	1.1	1.4	2.4	2.9	4.2	6.1	7.9	8.7	9.2	10.4	16.5	19.8
Attenuation dB/100 m	3.5	4.5	7.9	9.6	13.8	19.9	26.0	28.7	30.3	34.2	54.2	65.0
Avg. Power kW	2.09	1.62	0.92	0.76	0.52	0.36	0.28	0.25	0.24	0.21	0.13	0.11

Calculate Attenuation =  $(0.191930) \cdot \sqrt{\text{FMHz}} + (0.000330) \cdot \text{FMHz}$  (interactive calculator available at [http://www.timesmicrowave.com/cable\\_calculators](http://www.timesmicrowave.com/cable_calculators))  
 Attenuation: VSWR=1.0 ; Ambient = +25°C (77°F) Power: VSWR=1.0; Ambient = +40°C; Inner Conductor = 100°C (212°F);  
 Sea Level; dry air; atmospheric pressure; no solar loading



Connectors											
Interface	Description	Part Number	Stock Code	VSWR** Freq. (GHz)	Coupling Nut	Inner Contact Attach	Outer Contact Attach	Finish* Body /Pin	Length in (mm)	Width in (mm)	Weight lb (g)
1. N Male	Right Angle	TC-300-NMH-RA-D	3190-2761	<1.30:1 (2.5)	Hex/Knurl	Solder	Crimp	N/S	1.4 (35)	1.41 (35.8)	0.130 (59.0)
2. N Male	Straight Plug	TC-300-NMH-X	3190-2861	<1.25:1 (6)	Hex/Knurl	Solder	Crimp	A/G	1.3 (33)	0.86 (21.8)	0.084 (38.1)
3. N Male	Straight Plug	EZ-300-NMH-X	3190-2420	<1.25:1 (6)	Hex	Spring finger	Crimp	A/G	1.3 (34)	0.87 (22.0)	0.077(34.95)
4. N Female	Straight Jack	EZ-300-NF-X	3190-3078	<1.25:1 (6)	NA	Solder	Crimp	A/G	1.4 (36.5)	0.87 (22.0)	0.040 (18.0)
5. TNC Male	Straight Plug	TC-300-TM	3190-500	<1.25:1 (2.5)	Knurl	Solder	Crimp	N/G	1.7 (43)	0.59 (15.0)	0.050 (22.7)
6. SMA Male	Straight Plug	TC-300-SM	3190-501	<1.25:1 (2.5)	Hex	Solder	Crimp	SS/G	1.0 (25)	0.35 (8.9)	0.018 (8.2)
7. SMA Female	Bulkhead Jack	TC-300-SF-BH	3190-590	<1.25:1 (2.5)	NA	Solder	Crimp	SS/G	1.1 (28)	0.31 (7.9)	0.022 (10.0)
8. TNC Male	Straight Plug	EZ-300-TM-X	3190-2421	<1.25:1 (6)	Hex	Spring finger	Crimp	A/G	1.3 (32)	0.66 (16.8)	0.058 (26.2)

\* Finish metals: N=Nickel, S=Silver, G=Gold, SS=Stainless Steel, A=Alballoy \*\*VSWR spec based on 3 foot cable with a connector pair

## Hardware Accessories

Type	Part Number	Stock Code	Description
Ground Kit	GK-S300TT	GK-S300TT	Standard Ground Kit (each)



## Install Tools

Type	Part Number	Stock Code	Description
Crimp Tool	CT-400/300	3190-666	Crimp tool for LMR-300 connectors
Deburr Tool	DBT-U	3192-001	Removes center conductor rough edges
Cutting Tool	CCT-02	3192-165	Cable end flush cut tool
Prep Tool	CST-300	3192-084	Prep tool for LMR-300 Connectors
Replacement Blade Kit	RB-CST	3192-086	Replacement blade kit for all CST strip tools
Replacement Blade	RB-02	3192-166	Replacement blade for cutting tool



# LMR<sup>®</sup>-400 Flexible Low Loss Communications Coax

Ideal for...

- Drop-in replacement for RG-8/9913 Air-Dielectric type Cable
- Jumper Assemblies in Wireless Communications Systems
- Short Antenna Feeder runs
- Any application (e.g. WLL, GPS, LMR, WLAN, WISP, WiMax, SCADA, Mobile Antennas) requiring an easily routed, low loss RF cable
- **NEW!** Times Protect<sup>®</sup> LP-18-400 protector-series



Part Description					Stock
Part Number	Application	Jacket	Color	Code	
LMR-400	Outdoor	PE	Black	54001	
LMR-400-DB	Outdoor/Watertight	PE	Black	54091	
LMR-400-FR	Indoor/Outdoor Riser CMR	FRPE	Black	54030	
LMR-400-FR-PVC	Indoor/Outdoor Riser CMR	FRPVC	Black	54073	
LMR-400-PVC	General Purpose	PVC	Black	54218	
LMR-400-PVC-W	General Purpose	PVC	White	54204	

Construction Specifications			
Description	Material	In.	(mm)
Inner Conductor	Solid BCCAI	0.108	(2.74)
Dielectric	Foam PE	0.285	(7.24)
Outer Conductor	Aluminum Tape	0.291	(7.39)
Overall Braid	Tinned Copper	0.320	(8.13)
Jacket	(see table)	0.405	(10.29)

Environmental Specifications		
Performance Property	°F	°C
Installation Temperature Range	-40/+185	-40/+85
Storage Temperature Range	-94/+185	-70/+85
Operating Temperature Range	-40/+185	-40/+85

Mechanical Specifications			
Performance Property	Units	US	(metric)
Bend Radius: installation	in. (mm)	1.00	(25.4)
Bend Radius: repeated	in. (mm)	4.0	(101.6)
Bending Moment	ft-lb (N-m)	0.5	(0.68)
Weight	lb/ft (kg/m)	0.068	(0.10)
Tensile Strength	lb (kg)	160	(72.6)
Flat Plate Crush	lb/in. (kg/mm)	40	(0.71)

Electrical Specifications			
Performance Property	Units	US	(metric)
Velocity of Propagation	%	84	
Dielectric Constant	NA	1.38	
Time Delay	nS/ft (nS/m)	1.20	(3.92)
Impedance	ohms	50	
Capacitance	pF/ft (pF/m)	23.9	(78.4)
Inductance	uH/ft (uH/m)	0.060	(0.20)
Shielding Effectiveness	dB	>90	
DC Resistance			
Inner Conductor	ohms/1000ft (/km)	1.39	(4.6)
Outer Conductor	ohms/1000ft (/km)	1.65	(5.4)
Voltage Withstand	Volts DC	2500	
Jacket Spark	Volts RMS	8000	
Peak Power	kW	16	

TIMES MICROWAVE

Attenuation vs. Frequency (typical)

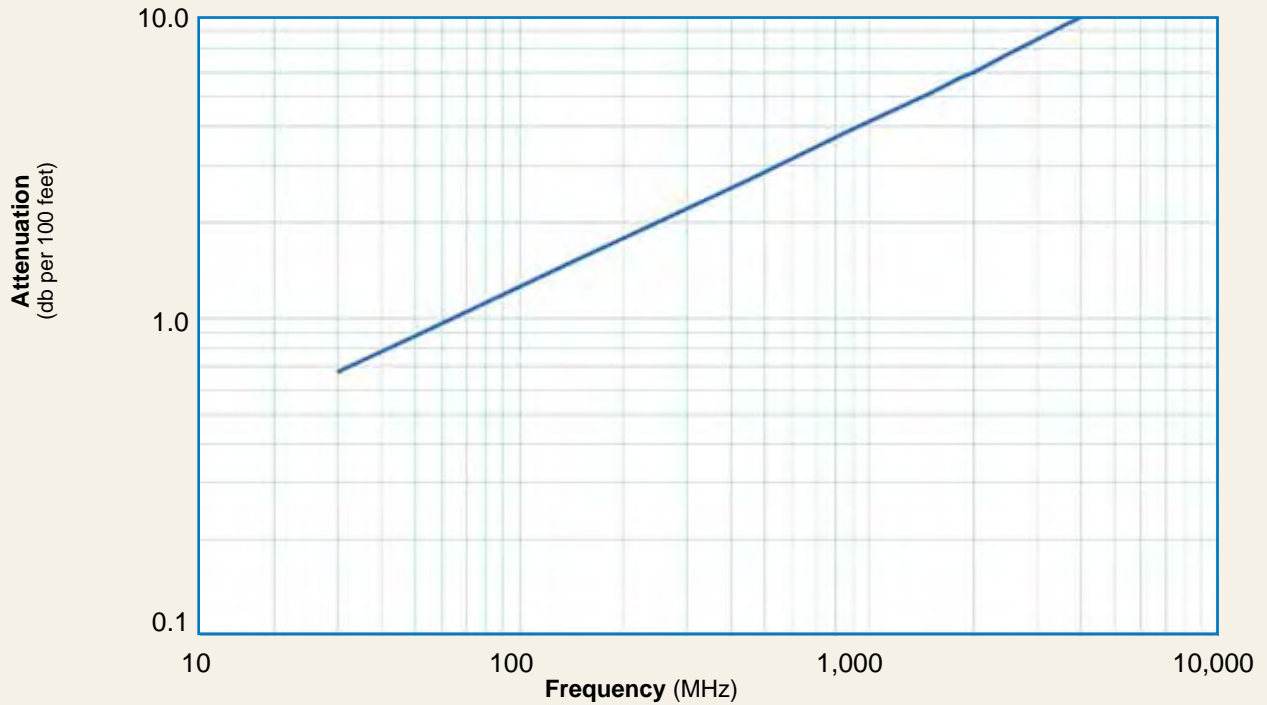

Frequency (MHz)	30	50	150	220	450	900	1500	1800	2000	2500	5800	8000
Attenuation dB/100 ft	0.7	0.9	1.5	1.9	2.7	3.9	5.1	5.7	6.0	6.8	10.8	13.0
Attenuation dB/100 m	2.2	2.9	5.0	6.1	8.9	12.8	16.8	18.6	19.6	22.2	35.5	42.7
Avg. Power kW	3.33	2.57	1.47	1.20	0.83	0.58	0.44	0.40	0.37	0.33	0.21	0.17

**Calculate Attenuation =**

$(0.122290) \cdot \sqrt{\text{FMHz}} + (0.000260) \cdot \text{FMHz}$  (interactive calculator available at [http://www.timesmicrowave.com/cable\\_calculators](http://www.timesmicrowave.com/cable_calculators))

**Attenuation:**

VSWR=1.0 ; Ambient = +25°C (77°F)

**Power:**

VSWR=1.0; Ambient = +40°C; Inner Conductor = 100°C (212°F); Sea Level; dry air; atmospheric pressure; no solar loading

**LMR® -400**  
Flexible Low Loss Communications

<b>Connectors</b>													
Interface	Description	Part Number	Stock Code	VSWR**	Coupling	Inner Contact Attach	Outer Contact Attach	Finish* /Pin	Length in (mm)	Width in (mm)	Weight (g)		
1. 4.1-9.5 mini DIN Female	Straight Jack	EZ-400-4195F-X	3190-2968	<1.25:1	(6)	Hex	Spring Finger Crimp	A/G	1.8 (45.0)	0.55 (14.0)	0.074	(33.6)	
2. 4.1-9.5 mini DIN Female	Straight Plug	EZ-400-4195M-X	3190-2969	<1.25:1	(6)	Hex	Spring Finger Crimp	A/G	1.5 (38.1)	0.89 (22.6)	0.103	(46.8)	
3. 716 DIN Female	Straight Jack	TC-400-716-FC	3190-376	<1.25:1	(2.5)	N/A	Solder Clamp	S/S	1.6 (41)	1.13 (28.7)	0.281	(127.5)	
4. 7-16 DIN	Right Angle	TC-400-716M-RA-D	3190-2598	<1.35:1	(6)	Hex	Solder Crimp	A/S	1.7 (43.20)	1.98 (50.3)	0.374	(169.5)	
5. 7-16 DIN Male	Straight Plug	EZ-400-716M-X	3190-2524	<1.25:1	(6)	Hex	Spring Finger Crimp	A/G	1.6 (39.5)	1.38 (35)	0.277	(126.0)	
6. 7-16 DIN Male	Straight Plug	TC-400-716M-X	3190-2597	<1.25:1	(6)	Hex	Solder Crimp	A/S	1.6 (39.5)	1.42 (36.0)	0.320	(145.0)	
7. 7-16 DIN Male	Straight Plug	TC-400-716-MC	3190-279	<1.25:1	(2.5)	Hex	Solder Clamp	S/S	1.4 (36)	1.40 (35.6)	0.268	(121.6)	
8. 7-16 DIN Male	Right Angle	TC-400-716MC-RA	3190-1671	<1.25:1	(<3)	Hex	Solder Clamp	A/S	2.4 (61.5)	1.88 (47.8)	0.35	(159)	
9. 7-16 DIN Male	Right Angle	EZ-400-716M-RA-X	3190-2545	<1.35:1	(6)	Hex	Spring Finger Crimp	A/G	1.6 (41.7)	1.75 (44.3)	0.374	(0.17)	
10. BNC Male	Straight Plug	TC-400-BM-X	3190-6232	<1.30:1	(4)	Knurl	Solder Crimp	A/G	1.8 (46.8)	0.60 (14.5)	0.630	(28.6)	
11. BNC Male	Straight Plug	EZ-400-BM-X	3190-2852	<1.35:1	(2)	Knurl	Spring Finger Crimp	A/G	1.7 (42.7)	0.56 (14.2)	0.066	(29.9)	
12. BNC Male	Right Angle	EZ-400-BM-RA-X	3190-2847	<1.35:1	(2)	Knurl	Spring Finger Crimp	A/G	1.9 (48.0)	1.32 (33.5)	0.097	(44.0)	
13. HN Male	Straight Plug	TC-400-HNM	3190-923	<1.25:1	(<1)	Knurl	Solder Clamp	S/G	2.3 (59.2)	0.88 (22.4)	0.25	(113.4)	
14. HN Male	Right Angle	TC-400-HNM-RA	3190-2541	<1.25:1	(2.5)	Hex	Solder Crimp	A/G	1.6 (41.4)	1.56 (39.6)	0.198	(90.0)	
15. UHF Male	Straight Plug	EZ-400-UM	3190-997	<1.25:1	(2.5)	Knurl	Spring Finger Crimp	N/G	1.8 (48)	0.80 (20.3)	0.076	(34.4)	
16. Mini-UHF	Straight Plug	TC-400-MUHF	3190-520	<1.25:1	(2.5)	Knurl	Solder Crimp	N/G	1.1 (28)	0.50 (12.7)	0.020	(9.1)	
17. N Female	Straight Jack	TC-400-NFC	3190-299	<1.25:1	(2.5)	N/A	Solder Clamp	N/S	1.6 (41)	0.75 (19.1)	0.119	(54.0)	
18. N Female	Straight Jack	EZ-400-NF-X	3190-2818	<1.25:1	(2.5)	N/A	Spring Finger Crimp	N/G	1.8 (45)	0.66 (16.8)	0.105	(47.6)	
19. N Female	Straight Jack	TC-400-NF-X	3190-2815	<1.25:1	(2.5)	N/A	Solder Crimp	N/G	1.8 (45)	0.66 (16.8)	0.105	(47.6)	
20. N Female	Bulkhead Jack	EZ-400-NF-BH	3190-518*	<1.25:1	(2.5)	N/A	Spring Finger Crimp	N/G	1.8 (46)	0.88 (22.4)	0.102	(46.3)	
21. N Female	Bulkhead Jack	TC-400-NFC-BH (A)	3190-872	<1.25:1	(2.5)	N/A	Solder Clamp	A/G	1.8 (46)	0.88 (22.4)	0.145	(65.8)	
22. N Male	Straight Plug	SC-400-NM	3190-1454	<1.25:1	(2.5)	Knurl	Solder Crimp	N/G	1.5 (38)	0.75 (19.1)	0.090	(40.8)	
23. N Male	Straight Plug	TC-400-NMC	3190-6077	<1.25:1	(2.5)	Knurl	Solder Clamp	N/G	1.5 (38)	0.70 (17.8)	0.121	(54.9)	
24. N Male	Straight Plug	EZ-400-NMC-2-D	3190-2640	<1.25:1	(2.5)	Hex/Knurl	Spring Finger Crimp	N/G	1.5 (38)	0.75 (19.1)	0.121	(54.9)	
25. N Male	Straight Plug	EZ-400-NMH-X	3190-2590	<1.25:1	(10)	Hex/Knurl	Spring Finger Crimp	A/G	1.5 (38)	0.89 (22.6)	0.103	(46.8)	
26. N Male	Straight Plug	TC-400-NMH-X	3190-2626	<1.25:1	(10)	Hex/Knurl	Solder Crimp	A/G	1.5 (38)	0.89 (22.6)	0.113	(51.3)	
27. N Male	Right Angle	EZ-400-NMH-RA-X	3190-2638	<1.35:1	(6)	Hex/Knurl	Spring Finger Crimp	A/G	1.87 (47)	1.42 (36.0)	0.177	(80.2)	
28. N Male	Right Angle	TC-400-NMH-RA-SS	3190-1668	<1.25:1	(2.5)	Hex	Solder Crimp	SS/G	1.5 (38.1)	0.89 (2.6)	0.130	(59.0)	
29. N Male	Right Angle	TC-400-NMH-RA-D	3190-2293*	<1.35:1	(6)	Hex/Knurl	Solder Crimp	A/G	1.8 (46)	1.25 (31.8)	0.130	(59.0)	
30. N Male	Right Angle	TC-400-NMC-RA (A)	3190-870	<1.35:1	(2.5)	Hex	Solder Clamp	A/G	1.8 (46)	1.25 (31.8)	0.150	(68.0)	
31. N Male	Reverse Polarity	TC-400-NM-RP	3190-960	<1.25:1	(2.5)	Knurl	Solder Crimp	N/G	1.5 (38)	0.75 (19.1)	0.090	(40.8)	
32. QN Male	Straight Plug	EZ-400-QNM-X	3190-2979	<1.25:1	(6)	Hex	Spring Finger Crimp	A/G	1.5 (38)	0.89 (22.6)	0.103	(46.8)	
33. QN Male	Straight Plug	TC-400-QNM-X	3190-6212	<1.25:1	(6)	Hex	Solder Crimp	A/G	2.0 (50.2)	0.74 (18.9)	0.103	(46.8)	
34. QN Male	Right Angle	EZ-400-QNM-RA-X	3190-2981	<1.25:1	(6)	Hex	Spring Finger Crimp	A/G	1.9 (47.0)	1.42 (36.0)	0.177	(80.2)	
35. QN Female	Straight Jack	EZ-400-QNF-X	3190-2980	<1.25:1	(6)	N/A	Spring Finger Crimp	A/G	1.8 (45.0)	0.66 (16.8)	0.105	(47.6)	
36. SMA Male	Straight Plug	TC-400-SM-X	3190-3046	<1.25:1	(8)	Hex	Solder Crimp	N/G	1.2 (29)	0.50 (12.7)	0.032	(14.5)	
37. SMA Female	Straight Jack	TC-400-SF-X	3190-6174	<1.35:1	(6)	N/A	Solder Crimp	A/G	1.2 (29.7)	0.50 (12.7)	0.026	(12.0)	
38. TNC Female	Reverse Polarity	TC-400-TF-RP	3190-1063	<1.25:1	(2.5)	N/A	Solder Crimp	N/G	1.8 (46)	0.55 (14.0)	0.074	(33.6)	
39. TNC Female	Reverse Polarity	EZ-400-TF-RP	3190-795	<1.25:1	(2.5)	N/A	Spring Finger Crimp	A/G	1.8 (46)	0.55 (14.0)	0.074	(33.6)	
40. TNC Female	Straight Jack	EZ-400-TF-X	3190-3049	<1.25:1	(6)	N/A	Spring Finger Crimp	A/G	1.8 (45)	0.55 (14.0)	0.074	(33.6)	
41. TNC Female	Straight Jack	TC-400-TF-X	3190-3051	<1.25:1	(6)	N/A	Solder Crimp	A/G	1.8 (45.0)	0.55 (14.0)	0.074	(33.6)	
42. TNC Male	Straight Plug	TC-400-TM-X	3190-2532	<1.25:1	(6)	Hex/Knurl	Solder Crimp	A/G	1.9 (48)	0.67 (17.5)	0.075	(34.3)	
43. TNC Male	Straight Plug	EZ-400-TM-X	3190-2533	<1.25:1	(6)	Hex/Knurl	Spring Finger Crimp	A/G	1.9 (48)	0.67 (17.5)	0.075	(34.3)	
44. TNC Male	Reverse Polarity	TC-400-TM-RP	3190-1062	<1.25:1	(2.5)	Knurl	Solder Crimp	N/G	1.7 (43)	0.59 (15.0)	0.074	(33.6)	
45. TNC Male	Reverse Polarity	EZ-400-TM-RP	3190-794	<1.25:1	(2.5)	Knurl	Spring Finger Crimp	A/G	1.7 (43)	0.59 (15.0)	0.074	(33.6)	
46. TNC Male	Right Angle	TC-400-TM-RA-D	3190-2671	<1.35:1	(6)	Hex/Knurl	Solder Crimp	A/G	1.4 (35)	1.41 (35.8)	0.130	(59.0)	
47. TNC Male	Right Angle	EZ-400-TM-RA-X	3190-2800	<1.24:1	(6)	Hex	Spring Finger Crimp	A/G	2.0 (50.0)	0.62 (15.7)	0.130	(59.0)	
48. TNC Male	Right Angle RP	TC-400-TM-RP-RA-D	3190-6147	<1.35:1	(6)	Hex	Solder Crimp	A/G	1.4 (36.0)	1.20 (30.3)	0.130	(59.0)	

\* Finish metals: N=Nickel, S=Silver, G=Gold, SS=Stainless Steel, A=Alballoy \*\*VSWR spec based on 3 foot cable with a connector \*Available in bulk pack

<p>1-2</p>  <p>EZ-400-4195F-X / 3190-2968 TC-400-4195M-X / 3190-2969</p>	<p>3</p>  <p>TC-400-716FC 3190-376</p>	<p>4</p>  <p>TC-400-716M-RA-D 3190-2598</p>	<p>5</p>  <p>EZ-400-716M-X 3190-2524</p>
<p>6</p>  <p>TC-400-716M-X 3190-2597</p>	<p>7</p>  <p>TC-400-716MC 3190-279</p>	<p>8</p>  <p>TC-400-716MC-RA 3190-1671</p>	<p>9</p>  <p>EZ-400-716M-RA-X 3190-2545</p>
<p>10</p>  <p>TC-400-BM-X 3190-6232</p>	<p>11</p>  <p>EZ-400-BM-X 3190-2852</p>	<p>12</p>  <p>EZ-400-BM-RA-X 3190-2847</p>	<p>13</p>  <p>TC-400-HNM 3190-923</p>
<p>14</p>  <p>TC-400-HNM-RA 3190-2541</p>	<p>15</p>  <p>EZ-400-UM 3190-997</p>	<p>16</p>  <p>TC-400-MUHF 3190-520</p>	<p>17</p>  <p>TC-400-NFC 3190-299</p>
<p>18</p>  <p>EZ-400-NF-X 3190-2818</p>	<p>19</p>  <p>TC-400-NF-X 3190-2815</p>	<p>20</p>  <p>EZ-400-NF-BH 3190-518</p>	<p>21</p>  <p>TC-400-NFC-BH (A) 3190-872</p>
<p>22</p>  <p>SC-400-NM 3190-1454</p>	<p>23</p>  <p>TC-400-NMC 3190-6077</p>	<p>24</p>  <p>EZ-400-NMC-2-D 3190-2640</p>	<p>25</p>  <p>EZ-400-NMH-X 3190-2590</p>
<p>26</p>  <p>TC-400-NMH-X 3190-2626</p>	<p>27</p>  <p>EZ-400-NMH-RA-X 3190-2638</p>		



 <p>28 TC-400-NMH-RA-SS 3190-1668</p>	 <p>29 TC-400-NMH-RA-D 3190-2293</p>	 <p>30 TC-400-NMC-RA (A) 3190-870</p>	 <p>31 TC-400-NM-RP 3190-960</p>
 <p>32 EZ-400-QNM-X 3190-2979</p>	 <p>33 TC-400-QNM-X 3190-6212</p>	 <p>34 EZ-400-QNM-RA-X 3190-2981</p>	 <p>35 EZ-400-QNF-X 3190-2980</p>
 <p>36 TC-400-SM-X 3190-3046</p>	 <p>37 TC-400-SF-X 3190-6174</p>	 <p>38-39 TC-400-TF-RP / 3190-1063 EZ-400-TF-RP / 3190-795</p>	 <p>40-41 EZ-400-TF / 3190-3049 TC-400-TF-X / 3190-3051</p>
 <p>42-43 TC-400-TM-X / 3190-2532 EZ-400-TM-X / 3190-2533</p>	 <p>44-45 TC-400-TM-RP / 3190-1062 EZ-400-TM-RP / 3190-794</p>	 <p>46-47 TC-400-TM-RA-D 3190-2671 EZ-400-TM-RA-X 3190-2800</p>	 <p>48 TC-400-TM-RP-RA-D 3190-6147</p>

## Hardware



Type	Part Number	Stock Code	Description
Hoisting Grip	HG-400T	HG-400T	Laced Type (each)
Ground Kit	GK-S400TT	GK-S400TT	Standard Ground Kit (each)
Weather Proof Boots	3109-417-1	IPB-400 NM	LMR-400 Male IP boot suitable for type N, TNC, BNC, 4310, 4195
Weather Proof Boots	3109-417-2	IPB-400 NM	LMR-400 Female IP boots suitable for type N, TNC, BNC, 4310, 4195
Weather Seal Strain Relief Boots	3109-394	WSB-400	Weather seal strain relief boots (10 pk) for use with most popular LMR-400-X series connectors



## Install Tools

Type	Part Number	Stock Code	Description
Crimp Tool	CT-U	3192-181	Crimp Handle
Crimp Dies	Y1719	3190-202	.429" Hex Dies
Crimp Tool	CT-400/300	3190-666	Crimp tool for LMR 400 connectors
Crimp Rings	CR-400	3190-830	Crimp rings for TC/EZ-400 connectors (package of 10)
Strip Tool	ST-400C-2	3190-1972	Prep tool for EZ-400-NMC-2 two piece clamp style connector
Strip Tool	CST-400	3192-004	Combination prep tool for LMR-400 crimp and clamp style connectors
Mid-Span Strip Tool	GST-400	3190-2174	For ground strap attachment
Replacement Blades	RB-456	3190-421	Replacement blades for Strip Tool
Deburr Tool	DBT-U	3192-001	Removes center conductor rough edges
Cutting Tool	CCT-02	3192-165	Cable end flush cut tool
Replacement Blade	RB-02	3192-166	Replacement blade for cutting tool
Tool Kit	TK-400EZ	3190-1601	Tool kit for LMR-400 Crimp Connectors (includes CCT-02, CST-400, CT-400/300, Tool Pouch)
Replacement Blade Kit	RB-CST	3192-086	Replacement blade kit for all CST strip tools

## LMR® lite-195 Flexible Low Loss Communications Coax

Ideal for...

- Jumper Assemblies in Wireless Communications Systems
- Short Antenna Feeder runs
- Any application (e.g. WLL, GPS, LMR, WLAN, WISP, WiMax, SCADA, Mobile Antennas) requiring an easily routed, low loss RF cable
- Drop-in replacement for RG-58 and RG-142



• **LMR-LW** is a lightweight low loss coaxial cable that employs an aluminum braid shield instead of the traditional tinned copper shield. LMR-LW has been designed and engineered with a combination of electrical, physical and mechanical properties that reduce weight and cost.

• **Flexibility** and bendability that are hallmarks of LMR are also the same for LMR-LW. The flexible outer conductor enables the tightest bend radius available for any cable of similar size and performance.

• **Low Loss** is another hallmark feature of LMR-LW. Size for size LMR® has the lowest loss of any flexible cable and comparable loss to semi rigid hard-line cables.

• **RF Shielding** is 50 dB greater than typical single shielded coax (40 dB). The multi-ply bonded foil outer conductor is rated conservatively at > 90 dB (i.e. >180 dB between two adjacent cables).

• **Weatherability:** LMR-LW cables designed for outdoor exposure incorporate the best materials for UV resistance and have life expectancy in excess of 20 years.

• **Connectors:** LMR-LW uses the same connectors, tools and installation accessories as standard LMR®. A wide variety of connectors are available for LMR-LW195 including all common interface types, reverse polarity, and a choice of solder or non-solder center pins. Most LMR

connectors employ crimp outer attachment using standard hex crimp sizes.

• **Cable Assemblies:** All LMR-LW cable types are available as pre-terminated cable assemblies.

Part Description				Stock
Part Number	Application	Jacket	Color	Code
LMR-LW195	Outdoor	PE	Black	45110

PE = Polyethylene

Construction Specifications			
Description	Material	In.	(mm)
Inner Conductor	Solid BC	0.037	(0.94)
Dielectric	Foam PE	0.110	(2.79)
Outer Conductor	Aluminum Tape	0.116	(2.95)
Overall Braid	Aluminum	0.139	(3.53)
Jacket	(See table above)	0.195	(4.95)

Mechanical Specifications			
Performance Property	Units	US	(metric)
Bend Radius: installation	in. (mm)	0.5	(12.7)
Bend Radius: repeated	in. (mm)	2	(50.8)
Bending Moment	ft-lb (N-m)	0.2	(0.27)
Weight	lb/ft (kg/m)	.015	(0.022)
Tensile Strength	lb (kg)	40	(18.2)
Flat Plate Crush	lb/in. (kg/mm)	15	(0.27)

Environmental Specifications		
Performance Property	°F	°C
Installation Temperature Range	-40/+185	-40/+85
Storage Temperature Range	-94/+185	-70/+85
Operating Temperature Range	-40/+185	-40/+85

MES MICROWAVE

Electrical Specifications			
Performance Property	Units	US	(metric)
Velocity of Propagation	%	80	
Dielectric Constant	NA	1.56	
Time Delay	nS/ft (nS/m)	1.27	(4.17)
Impedance	ohms	50	
Capacitance	pF/ft (pF/m)	25.4	(83.3)
Inductance	uH/ft (uH/m)	0.064	(0.21)
Shielding Effectiveness	dB	>90	
DC Resistance			
Inner Conductor	ohms/1000ft (/km)	7.6	(24.9)
Outer Conductor	ohms/1000ft (/km)	18.1	(59.4)
Voltage Withstand	Volts DC	1000	
Jacket Spark	Volts RMS	3000	
Peak Power	kW	2.5	

Attenuation vs. Frequency (typical)

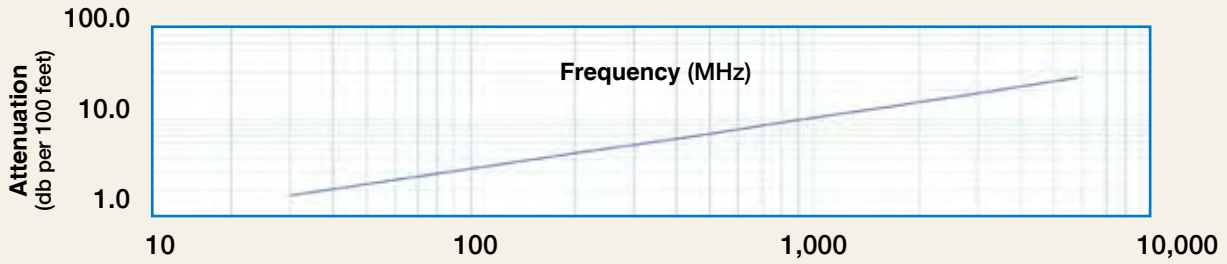

Frequency (MHz)	30	50	150	220	450	900	1500	1800	2000	2500	5800	8000
Attenuation dB/100 ft	2.0	2.5	4.4	5.4	7.8	11.1	14.5	16.0	16.9	19.0	29.9	35.7
Attenuation dB/100 m	6.5	8.4	14.6	17.7	25.5	36.5	47.7	52.5	55.4	62.4	98.1	117.1
Avg. Power kW	0.89	0.68	0.39	0.32	0.22	0.16	0.12	0.11	0.10	0.09	0.06	0.04

Calculate Attenuation =  $(0.356859) \cdot \sqrt{\text{FMHz}} + (0.000470) \cdot \text{FMHz}$  (interactive calculator available at [http://www.timesmicrowave.com/cable\\_calculators](http://www.timesmicrowave.com/cable_calculators))  
 Attenuation: VSWR=1.0 ; Ambient = +25°C (77°F) Power: VSWR=1.0; Ambient = +40°C; Inner Conductor = 100°C (212°F);  
 Sea Level; dry air; atmospheric pressure; no solar loading

# LMR® lite-200 Flexible Low Loss Communications Coax

Ideal for...

- Jumper Assemblies in Wireless Communications Systems
- Short Antenna Feeder runs
- Any application (e.g. WLL, GPS, LMR, WLAN, WISP, WiMax, SCADA, Mobile Antennas) requiring an easily routed, low loss RF cable



Part Description				Stock
Part Number	Application	Jacket	Color	Code
LMR-LW200	Outdoor	PE	Black	45022

PE = Polyethylene

Environmental Specifications			
Performance Property	°F	°C	
Installation Temperature Range	-40/+185	-40/+85	
Storage Temperature Range	-94/+185	-70/+85	
Operating Temperature Range	-40/+185	-40/+85	

Construction Specifications			
Description	Material	In.	(mm)
Inner Conductor	Solid BC	0.044	(1.12)
Dielectric	Foam PE	0.116	(2.95)
Outer Conductor	Aluminum Tape	0.121	(3.07)
Overall Braid	Aluminum	0.144	(3.66)
Jacket	(See table)	0.195	(4.95)

Mechanical Specifications			
Performance Property	Units	US	(metric)
Bend Radius: installation	in. (mm)	0.5	(12.7)
Bend Radius: repeated	in. (mm)	2	(50.8)
Bending Moment	ft-lb (N-m)	0.2	(0.27)
Weight	lb/ft (kg/m)	.015	(.022)
Tensile Strength	lb (kg)	40	(48)
Flat Plate Crush	lb/in. (kg/mm)	15	(0.27)

Electrical Specifications			
Performance Property	Units	US	(metric)
Velocity of Propagation	%	83	
Dielectric Constant	NA	1.45	
Time Delay	nS/ft (nS/m)	1.22	(4.02)
Impedance	ohms	50	
Capacitance	pF/ft (pF/m)	24.5	(80.3)
Inductance	uH/ft (uH/m)	0.061	(0.20)
Shielding Effectiveness	dB	>90	
DC Resistance			
Inner Conductor	ohms/1000ft (/km)	5.36	(17.6)
Outer Conductor	ohms/1000ft (/km)	18.1	(59.4)
Voltage Withstand	Volts DC	1000	
Jacket Spark	Volts RMS	3000	
Peak Power	kW	2.5	

Attenuation vs. Frequency (typical)

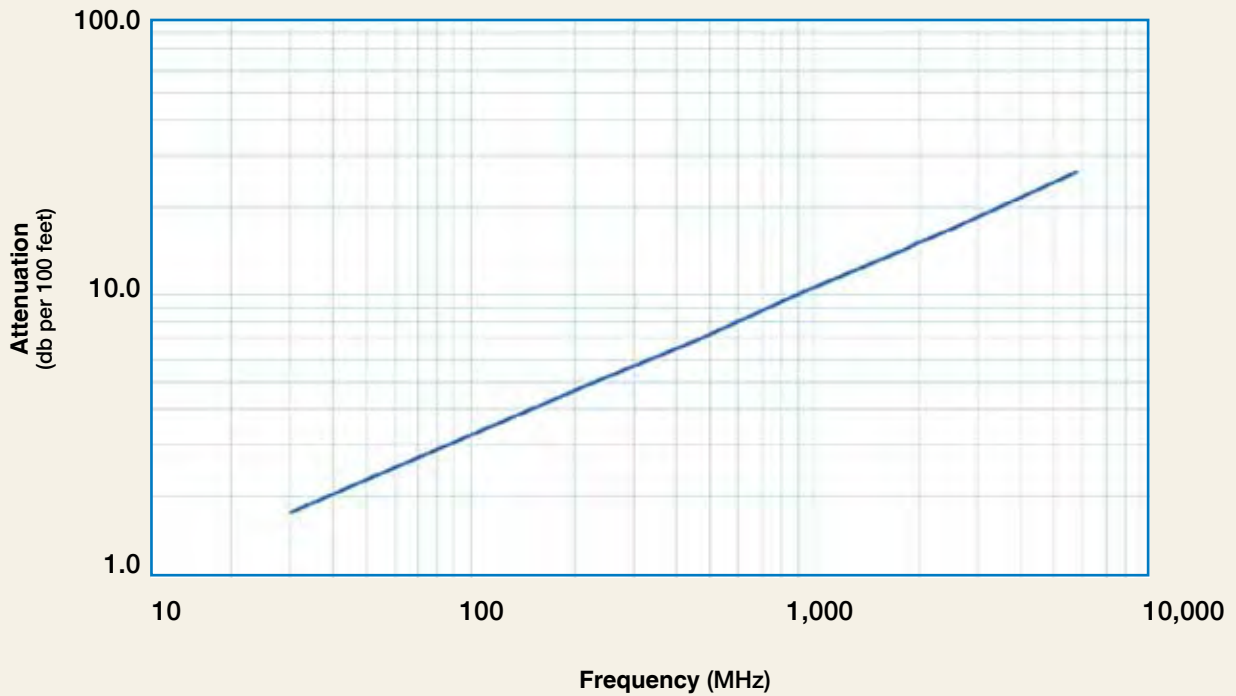

Frequency (MHz)	30	50	150	220	450	900	1500	1800	2000	2500	5800	8000
Attenuation dB/100 ft	1.8	2.3	4.0	4.8	7.0	9.9	12.9	14.2	15.0	16.9	26.4	31.3
Attenuation dB/100 m	5.8	7.5	13.1	15.9	22.8	32.6	42.4	46.6	49.3	55.4	86.5	102.8
Avg. Power kW	1.02	0.79	0.45	0.37	0.26	0.18	0.14	0.13	0.12	0.11	0.07	0.06

**Calculate Attenuation =**

$(0.320900) \cdot \sqrt{FMHz} + (0.000330) \cdot FMHz$  (interactive calculator available at [http://www.timesmicrowave.com/cable\\_calculators](http://www.timesmicrowave.com/cable_calculators))

**Attenuation:**

VSWR=1.0; Ambient = +25°C (77°F)

**Power:**

VSWR=1.0; Ambient = +40°C; Inner Conductor = 100°C (212°F); Sea Level; dry air; atmospheric pressure; no solar loading

# LMR® lite-240 Flexible Low Loss Communications Coax

Ideal for...

- Jumper Assemblies in Wireless Communications Systems
- Short Antenna Feeder runs (e.g. WLL, GPS, LMR, Mobile Antennas)
- Any application (e.g. WLL, GPS, LMR, WLAN, WISP, WiMax, SCADA, Mobile Antennas) requiring an easily routed, low loss RF cable



Part Description				Stock
Part Number	Application	Jacket	Color	Code
LMR-LW240	Outdoor	PE	Black	45021

PE = Polyethylene

Environmental Specifications		
Performance Property	°F	°C
Installation Temperature Range	-40/+185	-40/+85
Storage Temperature Range	-94/+185	-70/+85
Operating Temperature Range	-40/+185	-40/+85

Construction Specifications			
Description	Material	In.	(mm)
Inner Conductor	Solid BC	0.056	(1.42)
Dielectric	Foam PE	0.150	(3.81)
Outer Conductor	Aluminum Tape	0.155	(3.94)
Overall Braid	Aluminum	0.178	(4.52)
Jacket	(See table)	0.240	(6.10)

Mechanical Specifications			
Performance Property	Units	US	(metric)
Bend Radius: installation	in. (mm)	0.75	(19.1)
Bend Radius: repeated	in. (mm)	2.5	(63.5)
Bending Moment	ft-lb (N-m)	0.25	(0.39)
Weight	lb/ft (kg/m)	.026	(0.039)
Tensile Strength	lb (kg)	80	(36.3)
Flat Plate Crush	lb/in. (kg/mm)	20	(0.36)

Electrical Specifications			
Performance Property	Units	US	(metric)
Velocity of Propagation	%	83	
Dielectric Constant	NA	1.42	
Time Delay	nS/ft (nS/m)	1.21	(3.97)
Impedance	ohms	50	
Capacitance	pF/ft (pF/m)	24.2	(79.4)
Inductance	uH/ft (uH/m)	0.060	(0.20)
Shielding Effectiveness	dB	>90	
DC Resistance			
Inner Conductor	ohms/1000ft (/km)	3.2	(10.5)
Outer Conductor	ohms/1000ft (/km)	14.4	(47.2)
Voltage Withstand	Volts DC	1500	
Jacket Spark	Volts RMS	5000	
Peak Power	kW	5.6	

240 TIMES MICROWAVE

Attenuation vs. Frequency (typical)

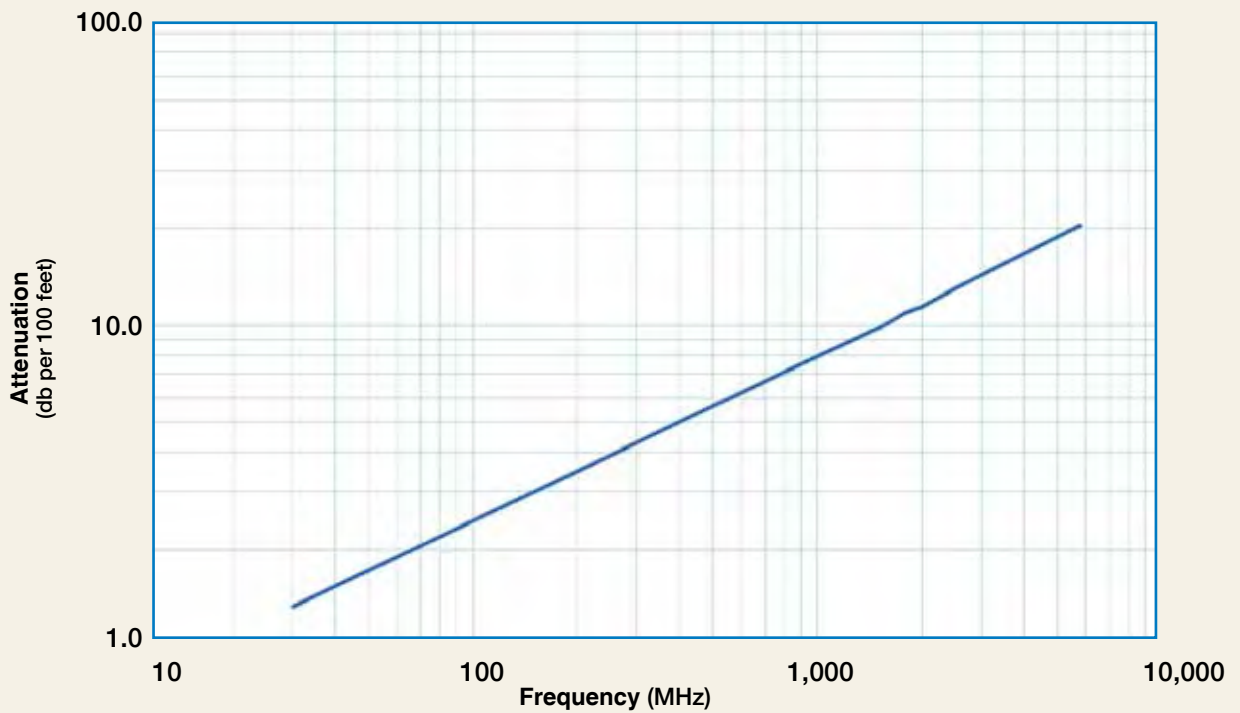

Frequency (MHz)	30	50	150	220	450	900	1500	1800	2000	2500	5800	8000
Attenuation dB/100 ft	1.3	1.7	3.0	3.7	5.3	7.6	9.9	10.9	11.5	12.9	20.4	24.3
Attenuation dB/100 m	4.4	5.7	9.9	12.0	17.3	24.8	32.4	35.6	37.7	42.4	66.8	79.7
Avg. Power kW	1.49	1.15	0.66	0.54	0.38	0.26	0.20	0.18	0.17	0.15	0.10	0.08

**Calculate Attenuation =**

$$(0.242080) \cdot \sqrt{\text{FMHz}} + (0.000330) \cdot \text{FMHz}$$

(interactive calculator available at [http://www.timesmicrowave.com/cable\\_calculators](http://www.timesmicrowave.com/cable_calculators))

**Attenuation:**

VSWR=1.0 ; Ambient = +25°C (77°F)

**Power:** VSWR=1.0; Ambient = +40°C; Inner Conductor = 100°C (212°F); Sea Level; dry air; atmospheric pressure; no solar loading



# LMR lite®-400 Flexible Low Loss Communications Coax

Ideal for...

- Drop-in replacement for RG-8/9913 Air-Dielectric type Cable
- Jumper Assemblies in Wireless Communications Systems
- Short Antenna Feeder runs
- Any application (e.g. WLL, GPS, LMR, WLAN, WISP, WiMax, SCADA, Mobile Antennas) requiring an easily routed, low loss RF cable



Part Description				Stock
Part Number	Application	Jacket Color		Code
LMR-LW400	Outdoor	PE Black		45001
LMR-LW400-DB	Outdoor	PE Black		45091

PE = Polyethylene

Environmental Specifications			
Performance Property	°F	°C	
Installation Temperature Range	-40/+185	-40/+85	
Storage Temperature Range	-94/+185	-70/+85	
Operating Temperature Range	-40/+185	-40/+85	

Construction Specifications			
Description	Material	In.	(mm)
Inner Conductor	Solid BCCAl	0.108	(2.74)
Dielectric	Foam PE	0.285	(7.24)
Outer Conductor	Aluminum Tape	0.291	(7.39)
Overall Braid	Aluminum	0.320	(8.13)
Jacket	(See table)	0.405	(10.29)

Mechanical Specifications			
Performance Property	Units	US	(metric)
Bend Radius: installation	in. (mm)	1.00	(25.4)
Bend Radius: repeated	in. (mm)	4.0	(101.6)
Bending Moment	ft-lb (N-m)	0.5	(0.50)
Weight	lb/ft (kg/m)	.050	(0.075)
Tensile Strength	lb (kg)	160	(72.6)
Flat Plate Crush	lb/in. (kg/mm)	40	(0.71)

Electrical Specifications			
Performance Property	Units	US	(metric)
Velocity of Propagation	%	84	
Dielectric Constant	NA	1.38	
Time Delay	nS/ft (nS/m)	1.20	(3.92)
Impedance	ohms	50	
Capacitance	pF/ft (pF/m)	23.9	(78.4)
Inductance	uH/ft (uH/m)	0.060	(0.20)
Shielding Effectiveness	dB	>90	
DC Resistance			
Inner Conductor	ohms/1000ft (/km)	1.39	(4.6)
Outer Conductor	ohms/1000ft (/km)	6.1	(20.0)
Voltage Withstand	Volts DC	2500	
Jacket Spark	Volts RMS	8000	
Peak Power	kW	16	

TIMES MICROWAVE

Attenuation vs. Frequency (typical)

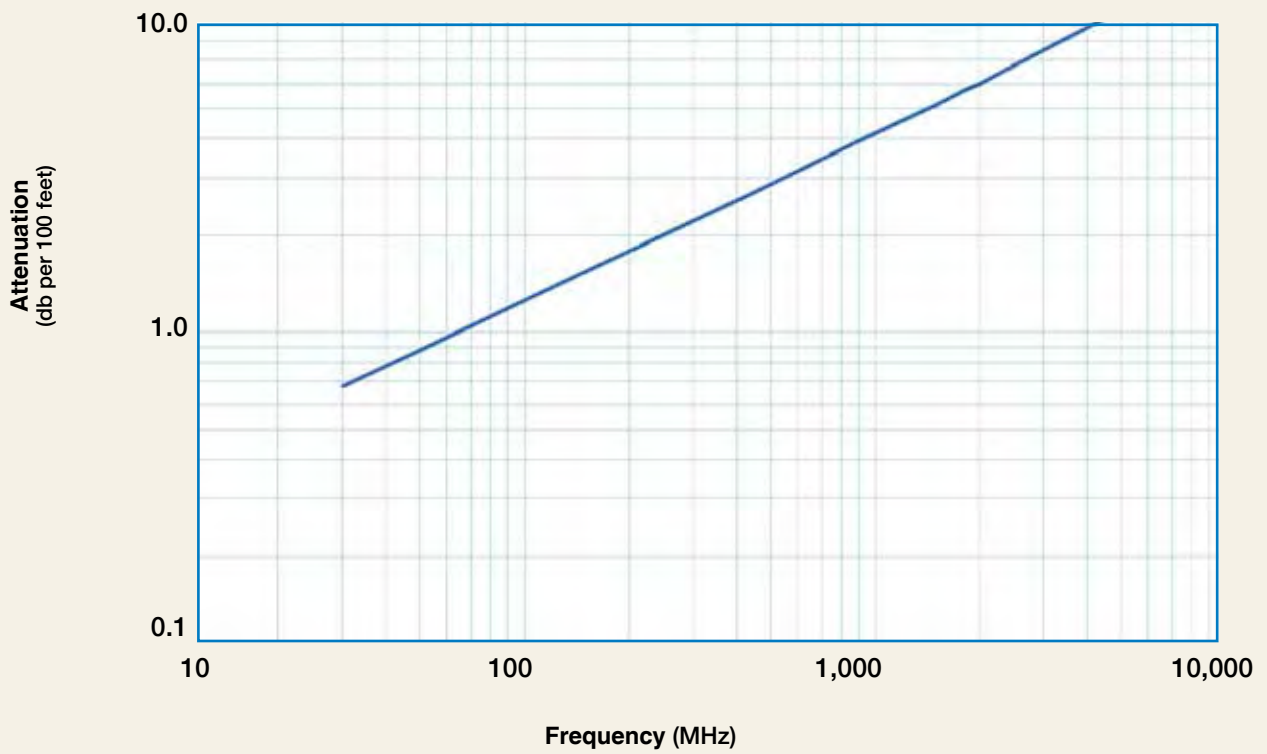

Frequency (MHz)	30	50	150	220	450	900	1500	1800	2000	2500	5800	8000
Attenuation dB/100 ft	0.7	0.9	1.5	1.9	2.7	3.9	5.1	5.7	6.0	6.8	10.8	13.0
Attenuation dB/100 m	2.2	2.9	5.0	6.1	8.9	12.8	16.8	18.6	19.6	22.2	35.5	42.7
Avg. Power kW	3.33	2.57	1.47	1.20	0.83	0.58	0.44	0.40	0.37	0.33	0.21	0.17

**Calculate Attenuation =**

$(0.122290) \cdot \sqrt{FMHz} + (0.000260) \cdot FMHz$  (interactive calculator available at [http://www.timesmicrowave.com/cable\\_calculators](http://www.timesmicrowave.com/cable_calculators))

**Attenuation:**

VSWR=1.0 ; Ambient = +25°C (77°F)

**Power:**

VSWR=1.0; Ambient = +40°C; Inner Conductor = 100°C (212°F); Sea Level; dry air; atmospheric pressure; no solar loading

# LMR® lite-600 Flexible Low Loss Communications Coax

Ideal for...

- Jumper Assemblies in Wireless Communications Systems
- Short Antenna Feeder runs
- Any application (e.g. WLL, GPS, LMR, WLAN, WISP, WiMax, SCADA, Mobile Antennas) requiring an easily routed, low loss RF cable



Part Description				Stock
Part Number	Application	Jacket	Color	Code
LMR-LW600	Outdoor	PE	Black	45003

PE = Polyethylene

Environmental Specifications		
Performance Property	°F	°C
Installation Temperature Range	-40/+185	-40/+85
Storage Temperature Range	-94/+185	-70/+85
Operating Temperature Range	-40/+185	-40/+85

Construction Specifications			
Description	Material	In.	(mm)
Inner Conductor	Solid BCCAI	0.176	(4.47)
Dielectric	Foam PE	0.455	(11.56)
Outer Conductor	Aluminum Tape	0.461	(11.71)
Overall Braid	Aluminum	0.490	(12.45)
Jacket	(see table)	0.590	(14.99)

Mechanical Specifications			
Performance Property	Units	US	(metric)
Bend Radius: installation	in. (mm)	1.50	(38.1)
Bend Radius: repeated	in. (mm)	6.0	(152.4)
Bending Moment	ft-lb (N-m)	2.75	(3.73)
Weight	lb/ft (kg/m)	.099	(.147)
Tensile Strength	lb (kg)	260	(118.0)
Flat Plate Crush	lb/in. (kg/mm)	60	(1.07)

Electrical Specifications			
Performance Property	Units	US	(metric)
Velocity of Propagation	%	85	
Dielectric Constant	NA	1.32	
Time Delay	nS/ft (nS/m)	1.17	(3.83)
Impedance	ohms	50	
Capacitance	pF/ft (pF/m)	23.4	(76.6)
Inductance	uH/ft (uH/m)	0.058	(0.19)
Shielding Effectiveness	dB	>90	
DC Resistance			
Inner Conductor	ohms/1000ft (/km)	0.53	(1.7)
Outer Conductor	ohms/1000ft (/km)	4.4	(14.8)
Voltage Withstand	Volts DC	4000	
Jacket Spark	Volts RMS	8000	
Peak Power	kW	40	

TIMES MICROWAVE

Attenuation vs. Frequency (typical)

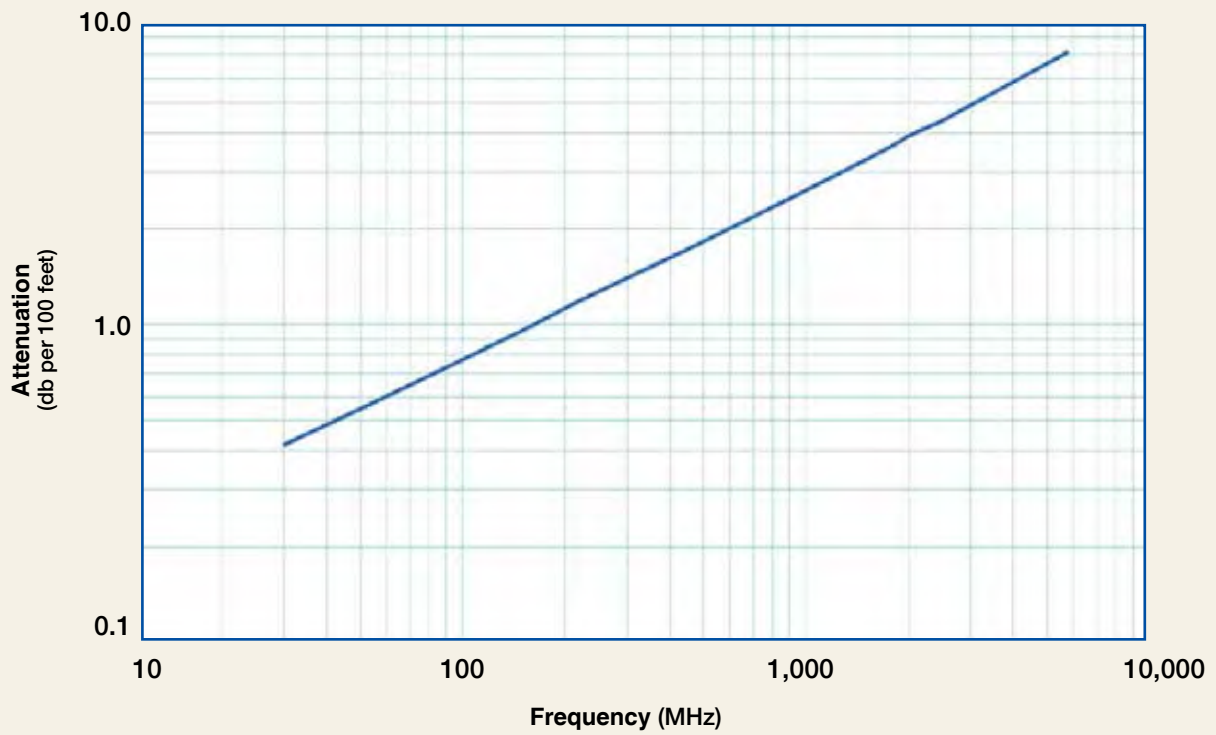

Frequency (MHz)	30	50	150	220	450	900	1500	1800	2000	2500	5800	8000
Attenuation dB/100 ft	0.4	0.5	1.0	1.2	1.7	2.5	3.3	3.7	3.9	4.4	7.3	8.8
Attenuation dB/100 m	1.4	1.8	3.2	3.9	5.6	8.2	10.9	12.1	12.8	14.5	23.8	29.0
Avg. Power kW	5.51	4.24	2.41	1.97	1.35	0.93	0.70	0.63	0.59	0.52	0.32	0.26

**Calculate Attenuation =**

$(0.075550) \cdot \sqrt{FMHz} + (0.000260) \cdot FMHz$  (interactive calculator available at [http://www.timesmicrowave.com/cable\\_calculators](http://www.timesmicrowave.com/cable_calculators))

**Attenuation:**

VSWR=1.0; Ambient = +25°C (77°F)

**Power:**

VSWR=1.0; Ambient = +40°C; Inner Conductor = 100°C (212°F); Sea Level; dry air; atmospheric pressure; no solar loading

# LMR®-195-UF UltraFlex Communications Coax

## Ideal for...

- Jumper Assemblies in Wireless Communications Systems
- Short Antenna Feeder runs
- Any application that requires additional flexibility



• **LMR®- UltraFlex** has a stranded center conductor and rubber outer jacket designed for multiple bending/flexing cycles. It is used for both indoor and outdoor applications.

• **Flexibility** and bendability are hallmarks of the LMR-UF cable design. The flexible outer conductor enables the tightest bend radius available for any cable of similar size and performance.

• **Low Loss** is another hallmark feature of LMR-UF. Size for size LMR has the lowest loss of any flexible cable and comparable loss to semirigid hard-line cables.

• **RF Shielding** is 50 dB greater than typical single shielded coax (40 dB). The multi-ply bonded foil outer conductor is rated conservatively at > 90 dB (i.e. >180 dB between two adjacent cables).

• **Weatherability:** LMR-UF cables are designed for outdoor exposure and have a life expectancy in excess of 10 years.

• **Connectors:** A wide variety of connectors are available for LMR cable, including all common interface types, reverse polarity, and solder-on center pins. Most LMR connectors employ crimp outer attachment using standard hex crimp sizes.

• **Cable Assemblies:** All LMR-UF cable types are available as pre-terminated cable assemblies. Refer to the section on FlexTech for further details.

Construction Specifications			
Description	Material	In.	(mm)
Inner Conductor	Stranded BC	0.038	(0.97)
Dielectric	Foam Polyethylene	0.110	(2.79)
Outer Conductor	Aluminum Tape	0.116	(2.95)
Overall Braid	Tinned Copper	0.139	(3.53)
Jacket	Black Thermoplastic Elastomer	0.195	(4.95)

Mechanical Specifications			
Performance Property	Units	US	(metric)
Bend Radius: installation	in. (mm)	0.5	(12.7)
Bend Radius: repeated	in. (mm)	2	(50.8)
Bending Moment	ft-lb (N-m)	0.1	(0.14)
Weight	lb/ft (kg/m)	0.021	(0.03)
Tensile Strength	lb (kg)	40	(18.2)
Flat Plate Crush	lb/in. (kg/mm)	10	(0.18)

Environmental Specifications		
Performance Property	°F	°C
Installation Temperature Range	-40/+185	-40/+85
Storage Temperature Range	-94/+185	-70/+85
Operating Temperature Range	-40/+185	-40/+85

Electrical Specifications			
Performance Property	Units	US	(metric)
Velocity of Propagation	%	74	
Dielectric Constant	NA	1.56	
Time Delay	nS/ft (nS/m)	1.27	(4.17)
Impedance	ohms	50	
Capacitance	pF/ft (pF/m)	25.4	(83.3)
Inductance	uH/ft (uH/m)	0.064	(0.21)
Shielding Effectiveness	dB	>90	
DC Resistance			
Inner Conductor	ohms/1000ft (/km)	9.5	(31.2)
Outer Conductor	ohms/1000ft (/km)	4.9	(16.1)
Voltage Withstand	Volts DC	1000	
Jacket Spark	Volts RMS	3000	
Peak Power	kW	2.5	

Part Description				
Part Number	Application	Jacket	Color	Stock Code
LMR-195-UF	Indoor/Outdoor	TPE	Black	54212

Attenuation vs. Frequency (typical)

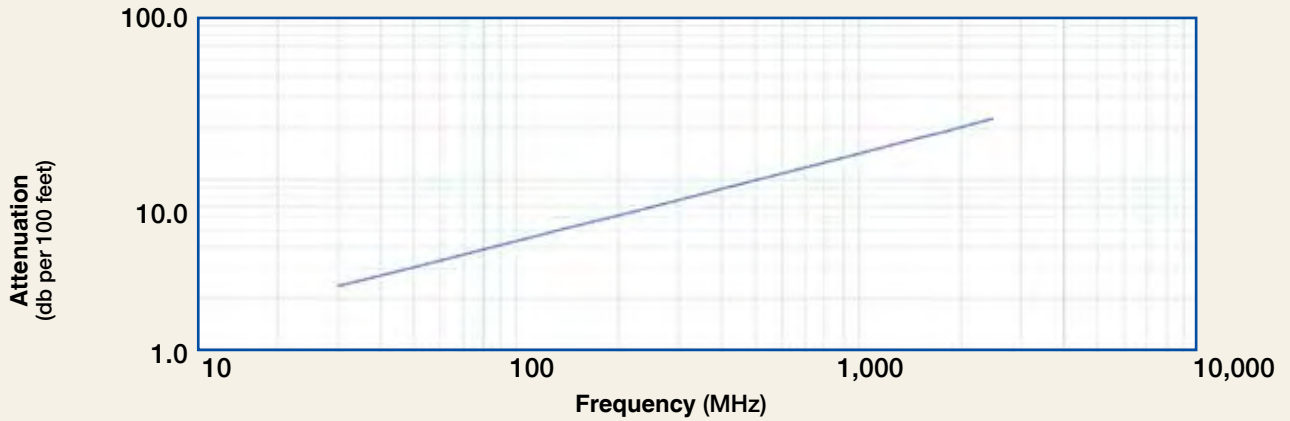

Frequency (MHz)	30	50	150	220	450	900	1500	1800	2000	2500	5800
Attenuation dB/100 ft	2.3	3.0	5.3	6.4	9.3	13.2	17.3	19.0	20.1	22.6	35.6
Attenuation dB/100 m	7.7	9.9	17.3	21.1	30.4	43.4	56.77	62.4	65.9	74.2	116.7
Avg. Power kW	0.78	0.61	0.35	0.28	0.20	0.14	0.10	0.09	0.09	0.08	0.05

Calculate Attenuation =  $(0.424232) \cdot \sqrt{FMHz} + (0.000563) \cdot FMHz$  (interactive calculator available at [http://www.timesmicrowave.com/cable\\_calculators](http://www.timesmicrowave.com/cable_calculators))  
 Attenuation: VSWR=1.0; Ambient = +25°C (77°F) Power: VSWR=1.0; Ambient = +40°C; Inner Conductor = 100°C (212°F);  
 Sea Level; dry air; atmospheric pressure; no solar loading

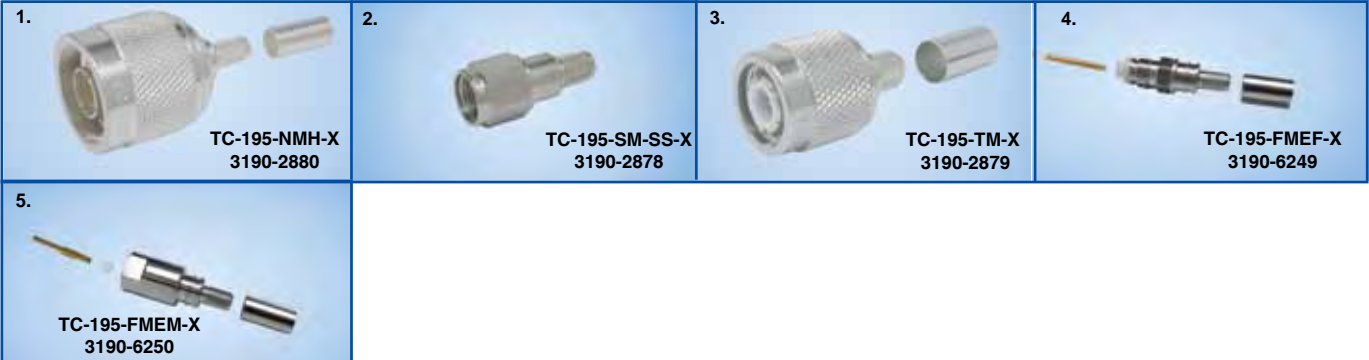

Connectors		Part Number	Stock Code	VSWR**	Coupling	Inner Contact Attach	Outer Contact Attach	Finish* Body /Pin	Length in (mm)	Width in (mm)	Weight lbs (g)
Interface	Description			Freq. (GHz)	Nut						
1. N Male	Straight Plug	TC-195-NMH-X	3190-2880	<1.25:1 (2.5)	Knurl	Solder	Crimp	S/G	1.5 (38.1)	0.75 (19.1)	0.073 (33.1)
2. SMA Male	Straight Plug	TC-195-SM-SS-X	3190-2878	<1.25:1 (2.5)	Hex	Solder	Crimp	SS/G	1.0 (25.4)	0.32 (8.1)	0.015 (6.8)
3. TNC Male	Straight Plug	TC-195-TM-X	3190-2879	<1.25:1 (2.5)	Knurl	Solder	Crimp	S/G	1.4 (35.6)	0.59 (15.0)	0.045 (20.4)
4. FME Female	Straight Jack	TC-195-FMEF-X	3190-6249	<1.25:1 (2)	Hex	Solder	Crimp	A/G	1.2 (29.3)	0.36 (9.2)	0.240 (6.1)
5. FME Male	Straight Plug	TC-200-FMEM-X	3190-6250	<1.25:1 (2)	Hex	Solder	Crimp	A/G	1.1 (28.1)	0.42 (10.8)	0.421 (10.7)



Install Tools

Type	Part Number	Stock Code	Description
Crimp Tool	CT-240/200/195/100	3190-667	Crimp tool for LMR-100, 195, 200 and 240 connectors
Cutting Tool	CCT-02	3192-165	Cable end flush cut tool
Replacement Blade	RB-02	3192-166	Replacement blade for cutting tool

# LMR<sup>®</sup>-200-UF UltraFlex Communications Coax

## Ideal for...

- Jumper Assemblies in Wireless Communications Systems
- Short Antenna Feeder runs
- Any application that requires additional flexibility



Part Description				
Part Number	Application	Jacket	Color	Stock Code
LMR-200-UF	Indoor/Outdoor	TPE	Black	54042

Environmental Specifications		
Performance Property	°F	°C
Installation Temperature Range	-40/+185	-40/+85
Storage Temperature Range	-94/+185	-70/+85
Operating Temperature Range	-40/+185	-40/+85

Construction Specifications			
Description	Material	In.	(mm)
Inner Conductor	Stranded BC	0.044	(1.12)
Dielectric	Foam Polyethylene	0.116	(2.95)
Outer Conductor	Aluminum Tape	0.121	(3.07)
Overall Braid	Tinned Copper	0.144	(3.66)
Jacket	Black Thermoplastic Elastomer	0.195	(4.95)

Electrical Specifications			
Performance Property	Units	US	(metric)
Velocity of Propagation	%	83	
Dielectric Constant	NA	1.45	
Time Delay	nS/ft (nS/m)	1.22	(4.02)
Impedance	ohms	50	
Capacitance	pF/ft (pF/m)	24.5	(80.3)
Inductance	uH/ft (uH/m)	0.061	(0.20)
Shielding Effectiveness	dB	>90	
DC Resistance			
Inner Conductor	ohms/1000ft (/km)	7.5	(24.6)
Outer Conductor	ohms/1000ft (/km)	4.9	(16.1)
Voltage Withstand	Volts DC	1000	
Jacket Spark	Volts RMS	3000	
Peak Power	kW	2.5	

Mechanical Specifications			
Performance Property	Units	US	(metric)
Bend Radius: installation	in. (mm)	0.5	(12.7)
Bend Radius: repeated	in. (mm)	2	(50.8)
Bending Moment	ft-lb (N-m)	0.1	(0.14)
Weight	lb/ft (kg/m)	0.022	(0.03)
Tensile Strength	lb (kg)	40	(18.2)
Flat Plate Crush	lb/in. (kg/mm)	10	(0.18)

Attenuation vs. Frequency (typical)

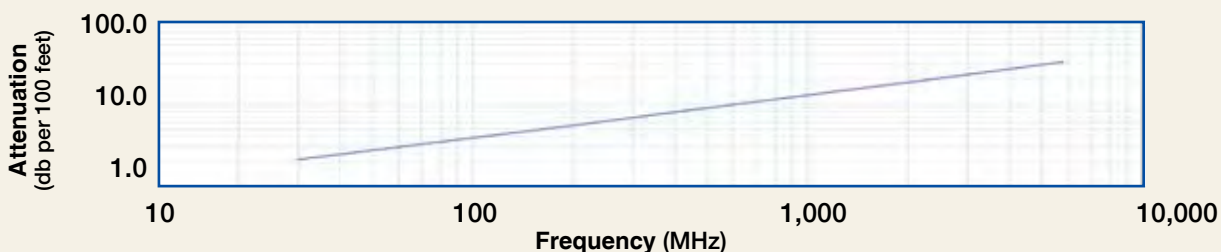

Frequency (MHz)	30	50	150	220	450	900	1500	1800	2000	2500	5800
Attenuation dB/100 ft	2.1	2.7	4.8	5.8	8.3	11.9	15.5	17.1	18.0	20.2	31.6
Attenuation dB/100 m	7.0	9.0	15.7	19.0	27.4	39.1	50.9	55.9	59.1	66.4	103.8
Avg. Power kW	0.95	0.73	0.42	0.35	0.24	0.17	0.13	0.12	0.11	0.10	0.06

Calculate Attenuation =  $(0.385082) \sqrt{\text{FMHz}} + (0.000396) \cdot \text{FMHz}$  (interactive calculator available at [http://www.timesmicrowave.com/cable\\_calculators](http://www.timesmicrowave.com/cable_calculators))  
 Attenuation: VSWR=1.0 ; Ambient = +25°C (77°F) Power: VSWR=1.0; Ambient = +40°C; Inner Conductor = 100°C (212°F);  
 Sea Level; dry air; atmospheric pressure; no solar loading

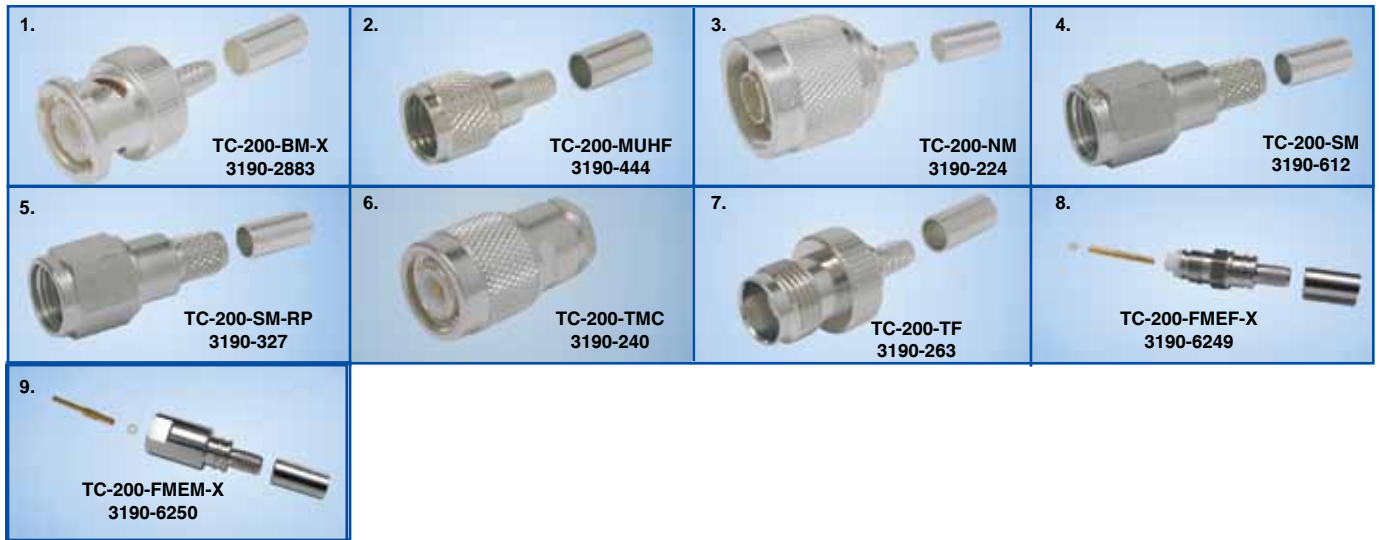

Connectors											
Interface	Description	Part Number	Stock Code	VSWR** Freq. (GHz)	Coupling Nut	Inner Contact Attach	Outer Contact Attach	Finish* Body /Pin	Length in (mm)	Width in (mm)	Weight lb (g)
1. BNC Male	Straight Plug	TC-200-BM-X	3190-2883	<1.25:1 (2.5)	Knurl	Solder	Crimp	S/G	1.7 (43.2)	0.56 (14.2)	0.045 (20.4)
2. Mini-UHF	Straight Plug	TC-200-MUHF	3190-444	<1.25:1 (2.5)	Knurl	Solder	Crimp	NG	1.1 (27.9)	0.45 (11.4)	0.015 (6.8)
3. N Male	Straight Plug	TC-200-NM	3190-224	<1.25:1 (2.5)	Knurl	Solder	Crimp	S/G	1.5 (38.1)	0.75 (19.1)	0.073 (33.1)
4. SMA Male	Straight Plug	TC-200-SM	3190-612	<1.25:1 (8)	Hex	Solder	Crimp	SS/G	1.0 (25.4)	0.32 (8.1)	0.015 (6.8)
5. SMA Male	Reverse Polarity	TC-200-SM-RP	3190-327	<1.25:1 (2.5)	Hex	Solder	Crimp	SS/G	1.0 (25.4)	0.32 (8.1)	0.015 (6.8)
6. TNC Male	Straight Plug	TC-200-TMC	3190-240	<1.25:1 (2.5)	Knurl	Solder	Clamp	S/G	1.7 (43.2)	0.59 (15.0)	0.045 (20.4)
7. TNC Female	Straight Jack	TC-200-TF	3190-263	<1.25:1 (2.5)	NA	Solder	Crimp	N/G	1.3 (33.0)	0.57 (14.5)	0.033 (15.0)
8. FME Female	Straight Jack	TC-200-FMEF-X	3190-6249	<1.25:1 (2)	Hex	Solder	Crimp	A/G	1.2 (29.3)	0.36 (9.2)	0.240 (6.1)
9. FME Male	Straight Plug	TC-200-FMEM-X	3190-6250	<1.25:1 (2)	NA	Solder	Crimp	A/G	1.1 (28.1)	0.42 (10.8)	0.421 (10.7)

## Hardware Accessories

Type	Part Number	Stock Code	Description
Ground Kit	GK-S200TT	GK-S200TT	Standard Ground Kit (each)



## Install Tools

Type	Part Number	Stock Code	Description
Crimp Tool	CT-240/200/195/100	3190-667	Crimp tool for LMR-100, 195, 200 and 240 connectors
Cutting Tool	CCT-02	3192-165	Cable end flush cut tool
Replacement Blade	RB-02	3192-166	Replacement blade for cutting tool





# LMR<sup>®</sup>-240-UF UltraFlex Communications Coax

## Ideal for...

- Jumper Assemblies in Wireless Communications Systems
- Short Antenna Feeder runs (e.g. WLL, GPS, LMR, Mobile Antennas)
- Any application that requires additional flexibility



Part Description				
Part Number	Application	Jacket	Color	Stock Code
LMR-240-UF	Indoor/Outdoor	TPE	Black	54041
LMR-240-UF-FR	Indoor/Outdoor	FRPE	Black	54143

Environmental Specifications		
Performance Property	°F	°C
Installation Temperature Range	-40/+185	-40/+85
Storage Temperature Range	-94/+185	-70/+85
Operating Temperature Range	-40/+185	-40/+85

Electrical Specifications			
Performance Property	Units	US	(metric)
Velocity of Propagation	%	80	
Dielectric Constant	NA	1.42	
Time Delay	nS/ft (nS/m)	1.21	(3.97)
Impedance	ohms	50	
Capacitance	pF/ft (pF/m)	24.2	(79.4)
Inductance	uH/ft (uH/m)	0.060	(0.20)
Shielding Effectiveness	dB	>90	
DC Resistance			
Inner Conductor	ohms/1000ft (/km)	4.28	(14.1)
Outer Conductor	ohms/1000ft (/km)	3.89	(12.8)
Voltage Withstand	Volts DC	1500	
Jacket Spark	Volts RMS	5000	
Peak Power	kW	5.6	

Construction Specifications			
Description	Material	In.	(mm)
Inner Conductor	Stranded BC	0.056	(1.42)
Dielectric	Foam Polyethylene	0.150	(3.81)
Outer Conductor	Aluminum Tape	0.155	(3.94)
Overall Braid	Tinned Copper	0.178	(4.52)
Jacket	(See Table)	0.240	(6.10)

Mechanical Specifications			
Performance Property	Units	US	(metric)
Bend Radius: installation	in. (mm)	0.75	(19.1)
Bend Radius: repeated	in. (mm)	2.5	(63.5)
Bending Moment	ft-lb (N-m)	0.125	(0.17)
Weight	lb/ft (kg/m)	0.034	(0.05)
Tensile Strength	lb (kg)	80	(36.3)
Flat Plate Crush	lb/in. (kg/mm)	13	(0.23)

## Attenuation vs. Frequency (typical)

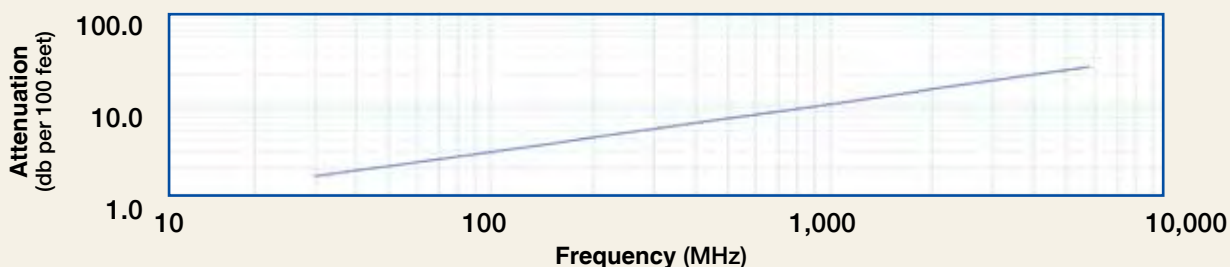

Frequency (MHz)	30	50	150	220	450	900	1500	1800	2000	2500	5800
Attenuation dB/100 ft	1.6	2.1	3.6	4.4	6.3	9.1	11.8	13.0	13.8	15.5	24.4
Attenuation dB/100 m	5.3	6.8	11.9	14.4	20.8	29.8	38.9	42.8	45.2	50.9	80.1
Avg. Power kW	1.24	0.96	0.55	0.45	0.31	0.22	0.17	0.15	0.14	0.13	0.08

Calculate Attenuation =  $(0.290501) \sqrt{\text{FMHz}} + (0.000396) \cdot \text{FMHz}$  (interactive calculator available at [http://www.timesmicrowave.com/cable\\_calculators](http://www.timesmicrowave.com/cable_calculators))  
 Attenuation: VSWR=1.0; Ambient = +25°C (77°F) Power: VSWR=1.0; Ambient = +40°C; Inner Conductor = 100°C (212°F);  
 Sea Level; dry air; atmospheric pressure; no solar loading



Connectors												
Interface	Description	Part Number	Stock Code	VSWR** Freq. (GHz)	Coupling Nut	Inner Contact Attach	Outer Contact Attach	Finish* Body /Pin	Length in (mm)	Width in (mm)	Weight lb (g)	
1. BNC Male	Straight Plug	TC-240-BMC	3190-242	<1.25:1 (2.5)	Knurl	Solder	Clamp	S/G	1.7 (43)	0.56 (14.2)	0.040 (18.1)	
2. Mini-UHF	Straight Plug	TC-240-MUHF	3190-445	<1.25:1 (2.5)	Knurl	Solder	Crimp	N/G	1.1 (28)	0.45 (11.4)	0.014 (6.4)	
3. N Female	Bulkhead Jack	TC-240-NF-BH-X	3190-2888	<1.25:1 (2.5)	NA	Solder	Crimp	A/G	1.7 (44)	0.88 (22.2)	0.115 (52.2)	
4. N Male	Straight Plug	TC-240-NMH-X	3190-2887	<1.25:1 (2.5)	Hex	Solder	Crimp	N/S	1.5 (38)	0.75 (19.1)	0.086 (39.0)	
5. N Male	Straight Plug	TC-240-NMC	3190-244	<1.25:1 (2.5)	Knurl	Solder	Clamp	S/G	1.5 (38)	0.75 (19.1)	0.082 (37.2)	
6. SMA Male	Straight Plug	TC-240-SM-SS-X	3190-2898	<1.25:1 (10)	Hex	Solder	Crimp	SS/G	1.0 (25)	0.32 (8.1)	0.016 (7.3)	
7. SMA Male	Reverse Polarity	TC-240-SM-RP	3190-326	<1.25:1 (2.5)	Hex	Solder	Crimp	SS/G	1.0 (25)	0.32 (8.1)	0.016 (7.3)	
8. TNC Male	Straight Plug	TC-240-TM-X	3190-2797	<1.25:1 (2.5)	Knurl	Solder	Crimp	N/S	1.7 (43)	0.59 (15.0)	0.043 (19.5)	
9. N Male	Right Angle	TC-240-NMH-RA-D	3190-2426	<1.35:1 (6)	Hex/Knurl	Solder	Crimp	A/G	1.2 (32.4)	1.22 (31.0)	0.091 (41.7)	
10. F Male	Straight Plug	TC-240-FM-X	3190-2891	<1.25:1 (2.5)	Knurl	Solder	Crimp	N/G	1.1 (28)	0.45 (11.4)	0.014 (6.4)	
11. FME Male	Straight Plug	TC-240-FMEM-X	3190-6251	<1.25:1 (2)	NA	Solder	Crimp	A/G	1.10 (28)	0.42 (10.8)	0.421 (10.7)	

\* Finish metals: N=Nickel, S=Silver, G=Gold, SS=Stainless Steel, A=Alballoy \*\*VSWR spec based on 3 foot cable with a connector pair

\* Finish metals: N=Nickel, S=Silver, G=Gold, SS=Stainless Steel, A=Alballoy \*\*VSWR spec based on 3 foot cable with a connector pair \*Available in bulk pack

## Hardware Accessories

Type	Part Number	Stock Code	Description
Ground Kit	GK-S240TT	GK-S240TT	Standard Ground Kit (each)

## Install Tools

Type	Part Number	Stock Code	Description
Crimp Tool	CT-240/200/195/100	3190-667	Crimp tool for LMR-100, 195, 200 and 240 connectors
Cutting Tool	CCT-02	3192-165	Cable end flush cut tool
Replacement Blade	RB-02	3192-166	Replacement blade for cutting tool



## LMR<sup>®</sup>-300-UF UltraFlex Communications Coax

### Ideal for...

- Jumper Assemblies in Wireless Communications Systems
- Short Antenna Feeder runs
- Any application that requires additional flexibility



Part Description				
Part Number	Application	Jacket	Color	Stock Code
LMR-300-UF	Indoor/Outdoor	TPE	Black	54088

Environmental Specifications		
Performance Property	°F	°C
Installation Temperature Range	-40/+185	-40/+85
Storage Temperature Range	-94/+185	-70/+85
Operating Temperature Range	-40/+185	-40/+85

Construction Specifications			
Description	Material	In.	(mm)
Inner Conductor	Stranded BC	0.070	(1.78)
Dielectric	Foam Polyethylene	0.190	(4.83)
Outer Conductor	Aluminum Tape	0.196	(4.98)
Overall Braid	Tinned Copper	0.225	(5.72)
Jacket	Black Thermoplastic Elastomer	0.300	(7.62)

Mechanical Specifications			
Performance Property	Units	US	(metric)
Bend Radius: installation	in. (mm)	0.88	(22.2)
Bend Radius: repeated	in. (mm)	3.0	(76.2)
Bending Moment	ft-lb (N-m)	0.2	(0.27)
Weight	lb/ft (kg/m)	0.055	(0.08)
Tensile Strength	lb (kg)	120	(54.5)
Flat Plate Crush	lb/in. (kg/mm)	20	(0.36)

Electrical Specifications			
Performance Property	Units	US	(metric)
Velocity of Propagation	%	85	
Dielectric Constant	NA	1.38	
Time Delay	nS/ft (nS/m)	1.20	(3.92)
Impedance	ohms	50	
Capacitance	pF/ft (pF/m)	23.9	(78.4)
Inductance	uH/ft (uH/m)	0.060	(0.20)
Shielding Effectiveness	dB	>90	
DC Resistance			
Inner Conductor	ohms/1000ft (/km)	2.96	(9.7)
Outer Conductor	ohms/1000ft (/km)	2.21	(7.3)
Voltage Withstand	Volts DC	2000	
Jacket Spark	Volts RMS	5000	
Peak Power	kW	10	

Attenuation vs. Frequency (typical)

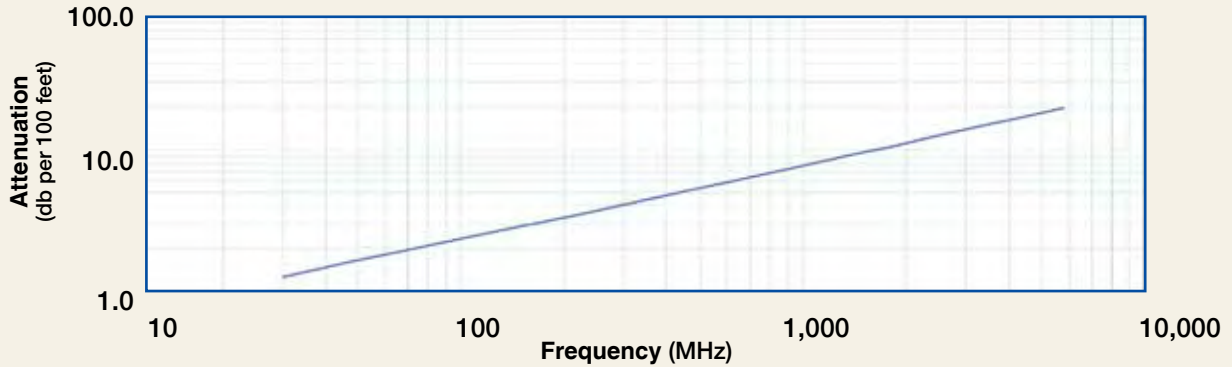

Frequency (MHz)	30	50	150	220	450	900	1500	1800	2000	2500	5800
Attenuation dB/100 ft	1.3	1.6	2.9	3.5	5.1	7.3	9.5	10.5	11.1	12.5	19.8
Attenuation dB/100 m	4.2	5.4	9.4	11.5	16.6	23.8	31.2	34.4	36.4	41.0	65.0
Avg. Power kW	1.74	1.35	0.77	0.63	0.44	0.30	0.23	0.21	0.20	0.18	0.11

Calculate Attenuation =  $(0.230316) \cdot \sqrt{\text{FMHz}} + (0.000392) \cdot \text{FMHz}$  (interactive calculator available at [http://www.timesmicrowave.com/cable\\_calculators](http://www.timesmicrowave.com/cable_calculators))  
 Attenuation: VSWR=1.0 ; Ambient = +25°C (77°F) Power: VSWR=1.0; Ambient = +40°C; Inner Conductor = 100°C (212°F);  
 Sea Level; dry air; atmospheric pressure; no solar loading

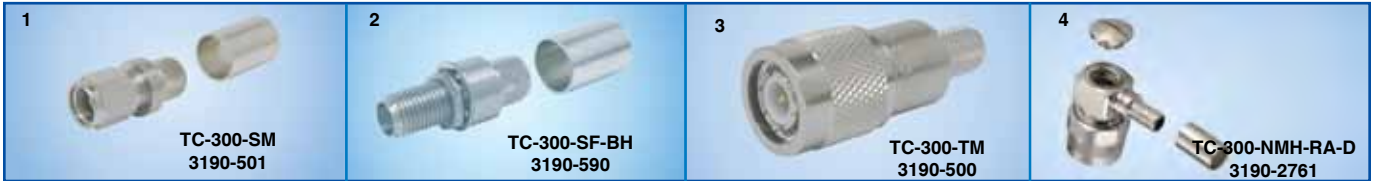

Connectors											
Interface	Description	Part Number	Stock Code	VSWR** Freq. (GHz)	Coupling Nut	Inner Contact Attach	Outer Contact Attach	Finish* Body /Pin	Length in (mm)	Width in (mm)	Weight lb (g)
1. SMA Male	Straight Plug	TC-300-SM	3190-501	<1.25:1 (2.5)	Hex	Solder	Crimp	SS/G	1.0 (25)	0.35 (8.9)	0.018 (8.2)
2. SMA Female	Bulkhead Jack	TC-300-SF-BH	3190-590	<1.25:1 (2.5)	NA	Solder	Crimp	SS/G	1.1 (28)	0.31 (7.9)	0.022 (10.0)
3. TNC Male	Straight Plug	TC-300-TM	3190-500	<1.25:1 (2.5)	Knurl	Solder	Crimp	N/S	1.7 (43)	0.59 (15.0)	0.050 (22.7)
4. N Male	Right Angle	TC-300-NMH-RA-D	3190-2761	<1.25:1 (2.5)	Knurl	Solder	Crimp	N/G	1.7 (43)	0.59 (15.0)	0.050 (22.7)

\* Finish metals: N=Nickel, S=Silver, G=Gold, SS=Stainless Steel, A=Alballoy \*\*VSWR spec based on 3 foot cable with a connector pair

## Hardware Accessories

Type	Part Number	Stock Code	Description
Ground Kit	GK-S300T	GK-S300T	Standard Ground Kit (each)



## Install Tools

Type	Part Number	Stock Code	Description
Crimp Tool	CT-400/300	3190-666	Crimp tool for LMR-300 UF connectors
Cutting Tool	CCT-02	3192-165	Cable end flush cut tool
Replacement Blade	RB-02	3192-166	Replacement blade for cutting tool

# LMR-® 400-UF UltraFlex Communications Coax

## Ideal for...

- Drop-in replacement for RG-8/9913 Air-Dielectric type Cable
- Jumper Assemblies in Wireless Communications Systems
- Short Antenna Feeder runs
- Any application that requires additional flexibility

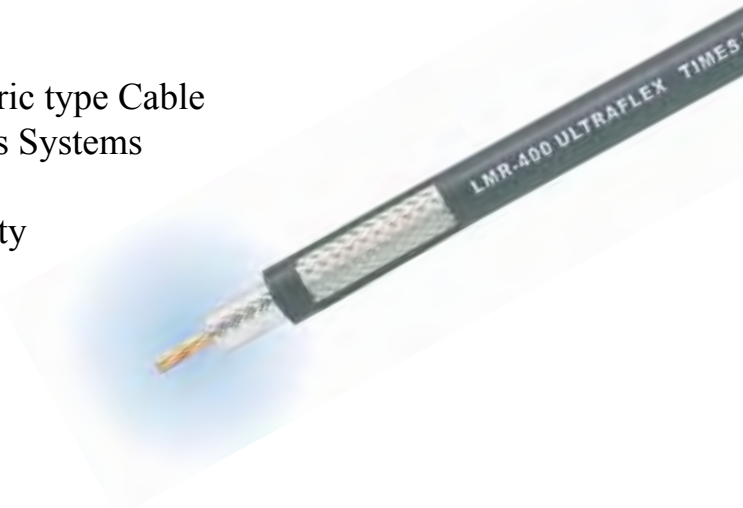

Part Description				
Part Number	Application	Jacket	Color	Stock Code
LMR-400-UF	Indoor/Outdoor	TPE	Black	54040
LMR-400-UF-FR	Indoor/Outdoor	FRPE	Black	54270

Environmental Specifications		
Performance Property	°F	°C
Installation Temperature Range	-40/+185	-40/+85
Storage Temperature Range	-94/+185	-70/+85
Operating Temperature Range	-40/+185	-40/+85

Construction Specifications			
Description	Material	In.	(mm)
Inner Conductor	Stranded BC	0.108	(2.74)
Dielectric	Foam Polyethylene	0.285	(7.24)
Outer Conductor	Aluminum Tape	0.291	(7.39)
Overall Braid	Tinned Copper	0.320	(8.13)
Jacket	(See table)	0.405	(10.29)

Mechanical Specifications			
Performance Property	Units	US	(metric)
Bend Radius: installation	in. (mm)	1.0	(25.4)
Bend Radius: repeated	in. (mm)	4.0	(101.6)
Bending Moment	ft-lb (N-m)	0.375	(0.51)
Weight	lb/ft (kg/m)	.088	(0.131)
Tensile Strength	lb (kg)	160	(72.6)
Flat Plate Crush	lb/in. (kg/mm)	20	(0.36)

Electrical Specifications			
Performance Property	Units	US	(metric)
Velocity of Propagation	%	83	
Dielectric Constant	NA	1.38	
Time Delay	nS/ft (nS/m)	1.20	(3.92)
Impedance	ohms	50	
Capacitance	pF/ft (pF/m)	23.9	(78.40)
Inductance	uH/ft (uH/m)	0.060	(0.21)
Shielding Effectiveness	dB	>90	
DC Resistance			
Inner Conductor	ohms/1000ft (/km)	1.07	(3.51)
Outer Conductor	ohms/1000ft (/km)	1.65	(5.4)
Voltage Withstand	Volts DC	2500	
Jacket Spark	Volts RMS	8000	
Peak Power	kW	16	

Attenuation vs. Frequency (typical)

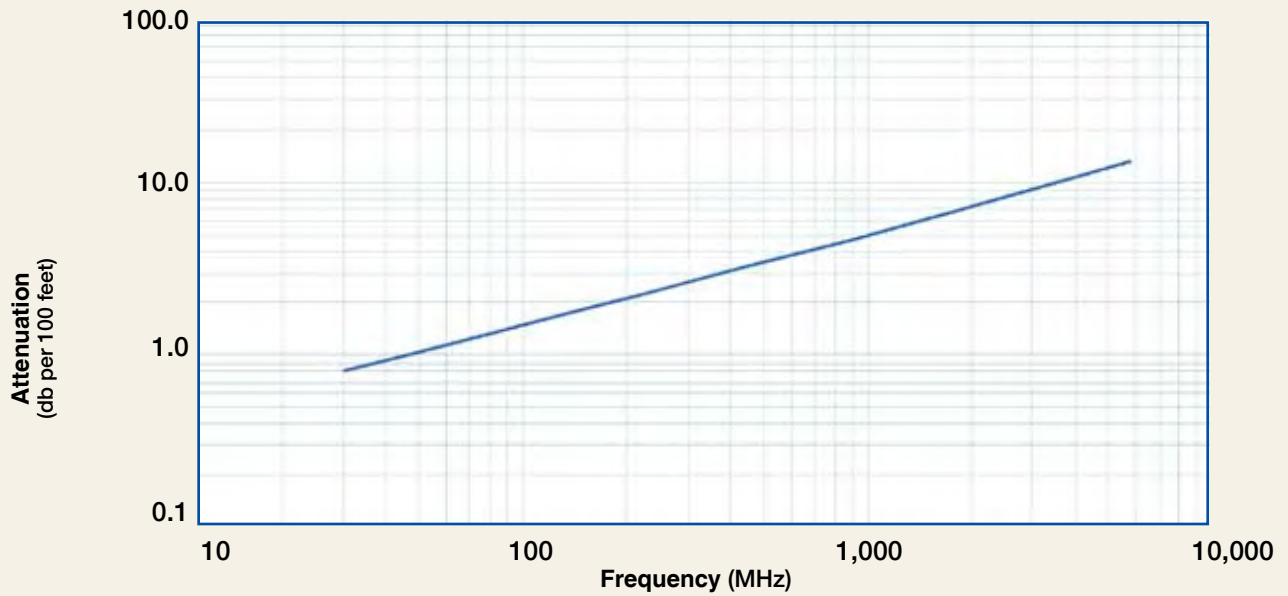

Frequency (MHz)	30	50	150	220	450	900	1500	1800	2000	2500	5800
Attenuation dB/100 ft	0.8	1.1	1.8	2.2	3.3	4.7	6.2	6.8	7.2	8.1	13.0
Attenuation dB/100 m	2.7	3.5	6.1	7.4	10.7	15.4	20.2	22.3	23.6	26.6	42.6
Avg. Power kW	2.77	2.14	1.22	1.00	0.69	0.48	0.36	0.33	0.31	0.28	0.17

Calculate Attenuation =  $(0.146748) \cdot \sqrt{\text{FMHz}} + (0.000312) \cdot \text{FMHz}$  (interactive calculator available at [http://www.timesmicrowave.com/cable\\_calculators](http://www.timesmicrowave.com/cable_calculators))  
 Attenuation: VSWR=1.0; Ambient = +25°C (77°F) Power: VSWR=1.0; Ambient = +40°C; Inner Conductor = 100°C (212°F);  
 Sea Level; dry air; atmospheric pressure; no solar loading

# LMR<sup>®</sup>-400-UF UltraFlex Communications Coax



## Connectors

Interface	Description	Part Number	Stock Code	VSWR** Freq. (GHz)	Coupling Nut	Inner Contact Attach	Outer Contact Attach	Finish* Body /Pin	Length in (mm)	Width in (mm)	Weight lb (g)
1. 7-16 DIN Female	Straight Jack	TC-400-716-FC	3190-376	<1.25:1 (2.5)	NA	Solder	Clamp	S/S	1.6 (41)	1.13 (28.7)	0.281 (127.5)
2. 7-16 DIN Male	Straight Plug	TC-400-716-MC	3190-279	<1.25:1 (2.5)	Hex	Solder	Clamp	S/S	1.4 (36)	1.40 (35.6)	0.268 (121.6)
3. 7-16 DIN Male	Straight Plug	TC-400-716M-X	3190-2597	<1.25:1 (6)	Hex	Solder	Crimp	A/S	1.6 (39.5)	1.42 (36.0)	0.320 (145.0)
4. BNC Male	Straight Plug	TC-400-BM-X	3190-6232	<1.30:1 (4)	Knurl	Solder	Crimp	A/G	1.8 (46.8)	0.60 (14.5)	0.630 (28.6)
5. Mini-UHF	Straight Plug	TC-400-MUHF	3190-520	<1.25:1 (2.5)	Knurl	Solder	Crimp	N/G	1.1 (28)	0.50 (12.7)	0.020 (9.1)
6. N Female	Straight Jack	TC-400-NFC	3190-299	<1.25:1 (2.5)	NA	Solder	Clamp	N/S	1.6 (41)	0.75 (19.1)	0.119 (54.0)
7. N Male	Straight Plug	SC-400-NM	3190-1454	<1.25:1 (2.5)	Knurl	Solder	Crimp	N/G	1.5 (38)	0.75 (19.1)	0.090 (40.8)
8. N Male	Straight Plug	TC-400-NM	3190-188	<1.25:1 (2.5)	Knurl	Solder	Crimp	N/G	1.5 (38)	0.75 (19.1)	0.090 (40.8)
9. N Male	Straight Plug	TC-400-NMH-X	3190-2626	<1.25:1 (10)	Hex/Knurl	Solder	Crimp	A/G	1.5 (38)	0.89 (22.6)	0.113 (51.3)
10. N Male	Straight Plug	TC-400-NMC	3190-277	<1.25:1 (2.5)	Knurl	Solder	Clamp	N/G	1.5 (38)	0.75 (19.1)	0.121 (54.9)
11. N Male	Right Angle	TC-400-NMH-RA-D	3190-2293*	<1.35:1 (6)	Hex/Knurl	Solder	Crimp	A/G	1.8 (46)	1.25 (31.8)	0.130 (59.0)
12. SMA Male	Straight Plug	TC-400-SM	3190-439	<1.25:1 (8)	Hex	Solder	Crimp	N/G	1.2 (29)	0.50 (12.7)	0.032 (14.5)
13. SMA Female	Straight Jack	TC-400-SF-X	3190-6174	<1.35:1 (6)	NA	Solder	Crimp	A/G	1.2 (29.7)	0.50 (12.7)	0.026 (12.0)
14. TNC Male	Straight Plug	TC-400-TM	3190-260	<1.25:1 (2.5)	Knurl	Solder	Crimp	N/S	1.7 (43)	0.59 (15.0)	0.074 (33.6)
15. TNC Male	Right Angle	TC-400-TM-RA-D	3190-2671	<1.35:1 (6)	Hex/Knurl	Solder	Crimp	A/G	1.4 (35)	1.41 (35.8)	0.130 (59.0)
16. TNC Male	Right Angle	TC-400-TM-RP-RA-D	3190-6147	<1.35:1 (6)	Hex	Solder	Crimp	A/G	1.4 (36.0)	1.20 (30.3)	0.130 (59.0)
17. TNC Male	Straight Plug	TC-400-TM-X	3190-2532	<1.25:1 (6)	Hex/Knurl	Solder	Crimp	A/G	1.9 (48)	0.67 (17.5)	0.075 (34.3)
18. TNC Female	Straight Jack	TC-400-TF-X	3190-3051	<1.25:1 (6)	NA	Solder	Crimp	A/G	1.8 (45.0)	0.55 (14.0)	0.074 (33.6)
19. QN Male	Straight Plug	TC-400-QNM-X	3190-6212	<1.25:1 (6)	Hex	Solder	Crimp	A/G	2.0 (50.2)	0.74 (18.9)	0.103 (46.8)

\* Finish metals: N=Nickel, S=Silver, G=Gold, SS=Stainless Steel, A=Alballoy \*\*VSWR spec based on 3 foot cable with a connector pair



## Hardware Accessories

Type	Part Number	Stock Code	Description
Ground Kit	GK-S400TT	GK-S400TT	Standard Grounding Kit (each)
Hoisting Grip	HG-400T	HG-400T	Laced Type (each)



## Install Tools

Type	Part Number	Stock Code	Description
Crimp Tool	CT-U	3192-181	Crimp Handle (Dies Required)
Crimp Dies	Y1719	3190-202	.429" Hex Dies
Crimp Tool	CT-400/300	3190-666	Crimp tool for LMR 400 connectors
Crimp Rings	CR-400	3190-830	Crimp rings for TC/EZ-400 connectors (package of 10)
Cutting Tool	CCT-02	3192-165	Cable end flush cut tool
Replacement Blade	RB-02	3192-166	Replacement blade for cutting tool



## LMR®-500-UF UltraFlex Communications Coax

Ideal for...

- Jumper Assemblies in Wireless Communications Systems
- Short Antenna Feeder runs
- Any application that requires additional flexibility



Part Description				
Part Number	Application	Jacket	Color	Stock Code
LMR-500-UF	Indoor/Outdoor	TPE	Black	54043

Environmental Specifications		
Performance Property	°F	°C
Installation Temperature Range	-40/+185	-40/+85
Storage Temperature Range	-94/+185	-70/+85
Operating Temperature Range	-40/+185	-40/+85

Electrical Specifications			
Performance Property	Units	US	(metric)
Velocity of Propagation	%	85	
Dielectric Constant	NA	1.38	
Time Delay	nS/ft (nS/m)	1.20	(3.92)
Impedance	ohms	50	
Capacitance	pF/ft (pF/m)	23.9	(78.4)
Inductance	uH/ft (uH/m)	0.060	(0.20)
Shielding Effectiveness	dB	>90	
DC Resistance			
Inner Conductor	ohms/1000ft (/km)	0.68	(2.21)
Outer Conductor	ohms/1000ft (/km)	1.27	(4.2)
Voltage Withstand	Volts DC	2500	
Jacket Spark	Volts RMS	8000	
Peak Power	kW	22	

Construction Specifications			
Description	Material	In.	(mm)
Inner Conductor	Stranded BC	0.142	(3.61)
Dielectric	Foam Polyethylene	0.370	(9.40)
Outer Conductor	Aluminum Tape	0.376	(9.55)
Overall Braid	Tinned Copper	0.405	(10.29)
Jacket	Black Thermoplastic Elastomer	0.500	(12.70)

Mechanical Specifications			
Performance Property	Units	US	(metric)
Bend Radius: installation	in. (mm)	1.25	(31.8)
Bend Radius: repeated	in. (mm)	5.0	(127.0)
Bending Moment	ft-lb (N-m)	1.25	(1.69)
Weight	lb/ft (kg/m)	0.1	(0.15)
Tensile Strength	lb (kg)	260	(118.0)
Flat Plate Crush	lb/in. (kg/mm)	35	(0.63)

Attenuation vs. Frequency (typical)

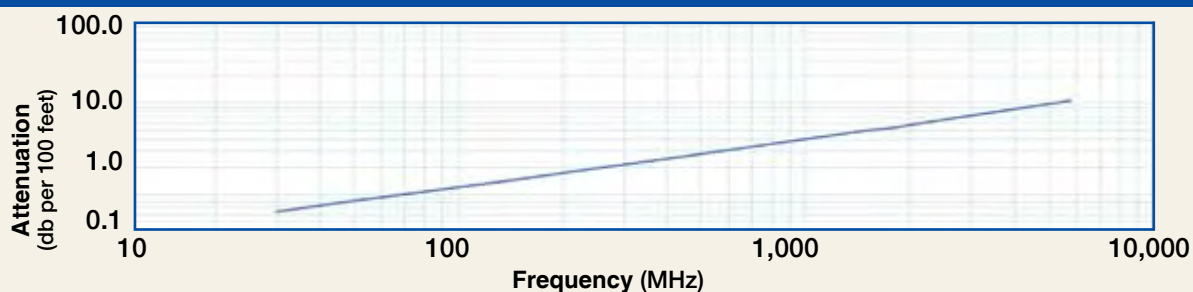

Frequency (MHz)	30	50	150	220	450	900	1500	1800	2000	2500	5800
Attenuation dB/100 ft	0.6	0.8	1.5	1.8	2.6	3.8	5.0	5.5	5.8	6.6	10.6
Attenuation dB/100 m	2.1	2.7	4.8	5.9	8.5	12.3	16.3	18.0	19.1	21.6	34.9
Avg. Power kW	3.68	2.84	1.61	1.32	0.91	0.63	0.48	0.43	0.41	0.36	0.22

Calculate Attenuation =  $(0.115908) \cdot \sqrt{\text{FMHz}} + (0.000312) \cdot \text{FMHz}$  (interactive calculator available at [http://www.timesmicrowave.com/cable\\_calculators](http://www.timesmicrowave.com/cable_calculators))  
 Attenuation: VSWR=1.0; Ambient = +25°C (77°F) Power: VSWR=1.0; Ambient = +40°C; Inner Conductor = 100°C (212°F);  
 Sea Level; dry air; atmospheric pressure; no solar loading



Connectors		Part Number	Stock Code	VSWR	Coupling	Inner Contact Attach	Outer Contact Attach	Finish* /Pin	Length in (mm)	Width in (mm)	Weight lb (g)
1. 7-16 DIN Female	Straight Jack	TC-500-716F-X	3190-2906	<1.30:1 (6)	NA	Solder	Crimp	A/S	1.8 (45.9)	1.14 (29.0)	0.298(135.0)
2. 7-16 DIN Male	Right Angle	TC-500-716M-RA-D	3190-6079	<1.30:1 (6)	Hex	Solder	Crimp	A/S	1.8 (44.9)	1.60 (41.6)	0.370(168.0)
3. N Male	Straight Plug	TC-500-NMH-X	3190-2514	<1.35:5 (6)	Hex/Knurl	Solder	Crimp	A/G	1.8 (45)	0.87 (22.0)	0.099 (45.0)
4. N Male	Right Angle	TC-500-NMH-RA-D	3190-2513	<1.25:1 (6)	Hex/Knurl	Solder	Crimp	A/G	1.5 (39)	1.6 (42.0)	0.279 (127.0)
5. N Male	Straight Plug	TC-500-NMC	3190-377*	<1.25:1 (2.5)	Hex	Solder	Clamp	S/G	2.1 (53)	0.92 (23.4)	0.228 (103.4)
6. N Male	Right Angle	TC-500-NMC-RA	3190-227*	<1.35:1 (2.5)	Hex	Solder	Clamp	S/G	2.4 (61)	1.5 (38.1)	0.275 (124.7)
7. N Female	Straight Jack	TC-500-NFC	3190-215	<1.25:1 (2.5)	NA	Solder	Clamp	S/G	2.2 (56)	0.94 (23.9)	0.215 (97.5)
8. TNC Male	Straight Plug	TC-500-TM	3190-464	<1.25:1 (2.5)	Hex	Solder	Crimp	N/G	1.5 (38)	0.62 (15.7)	0.082 (28.1)
9. TNC Female	Straight Jack	TC-500-TF-X	3190-6010	<1.30:1 (6)	NA	Solder	Crimp	A/G	1.8 (44.5)	0.87 (22.0)	0.077 (35.0)
10. UHF Male	Straight Plug	TC-500-UMC	3190-354	<1.25:1 (2.5)	Knurl	Solder	Clamp	S/G	2.1 (53)	0.88 (22.4)	0.215 (97.5)
11.	Bulkhead Kit	BHA-KIT	3190-223	<1.25:1 (2.5)	NA	NA	NA	NA	NA	NA	0.014 (6.4)



## Install Tools

Type	Part Number	Stock Code	Description
Crimp Tool	CT-U	3192-181	Crimp Handle (Dies Required)
Crimp Tool	CT-500	3192-169	Crimp Tool for LMR-500 Connectors
Crimp Dies	Y151	3190-465	.532" Hex Dies
Cutting Tool	CCT-02	3192-165	Cable end flush cut tool
Replacement Blade	RB-02	3192-166	Replacement blade for cutting tool

Type	Part Number	Stock Code	Description
Ground Kit	GK-S500TT	GK-S500TT	Standard Ground Kit (each)



# LMR<sup>®</sup>-600-UF UltraFlex Communications Coax

Ideal for...

- Jumper Assemblies in Wireless Communications Systems
- Short Antenna Feeder runs
- Any application that requires periodic/repeated flexing



Part Description				
Part Number	Application	Jacket	Color	Stock Code
LMR-600-UF	Indoor/Outdoor	TPE	Black	54044

Environmental Specifications			
Performance Property	°F	°C	
Installation Temperature Range	-40/+185	-40/+85	
Storage Temperature Range	-94/+185	-70/+85	
Operating Temperature Range	-40/+185	-40/+85	

Construction Specifications			
Description	Material	In.	(mm)
Inner Conductor	Stranded BC	0.176	(4.47)
Dielectric	Foam Polyethylene	0.455	(11.56)
Outer Conductor	Aluminum Tape	0.461	(11.71)
Overall Braid	Tinned Copper	0.490	(12.45)
Jacket	Black Thermoplastic Elastomer	0.590	(14.99)

Mechanical Specifications			
Performance Property	Units	US	(metric)
Bend Radius: installation	in. (mm)	1.5	(38.1)
Bend Radius: repeated	in. (mm)	6.0	(152.4)
Bending Moment	ft-lb (N-m)	1.75	(2.37)
Weight	lb/ft (kg/m)	0.165	(0.25)
Tensile Strength	lb (kg)	350	(158.9)
Flat Plate Crush	lb/in. (kg/mm)	40	(0.71)

Electrical Specifications			
Performance Property	Units	US	(metric)
Velocity of Propagation	%	87	
Dielectric Constant	NA	1.32	
Time Delay	nS/ft (nS/m)	1.17	(3.83)
Impedance	ohms	50	
Capacitance	pF/ft (pF/m)	23.4	(76.6)
Inductance	uH/ft (uH/m)	0.058	(0.19)
Shielding Effectiveness	dB	>90	
DC Resistance			
Inner Conductor	ohms/1000ft (/km)	0.43	(1.42)
Outer Conductor	ohms/1000ft (/km)	1.2	(3.9)
Voltage Withstand	Volts DC	4000	
Jacket Spark	Volts RMS	8000	
Peak Power	kW	40	

Attenuation vs. Frequency (typical)

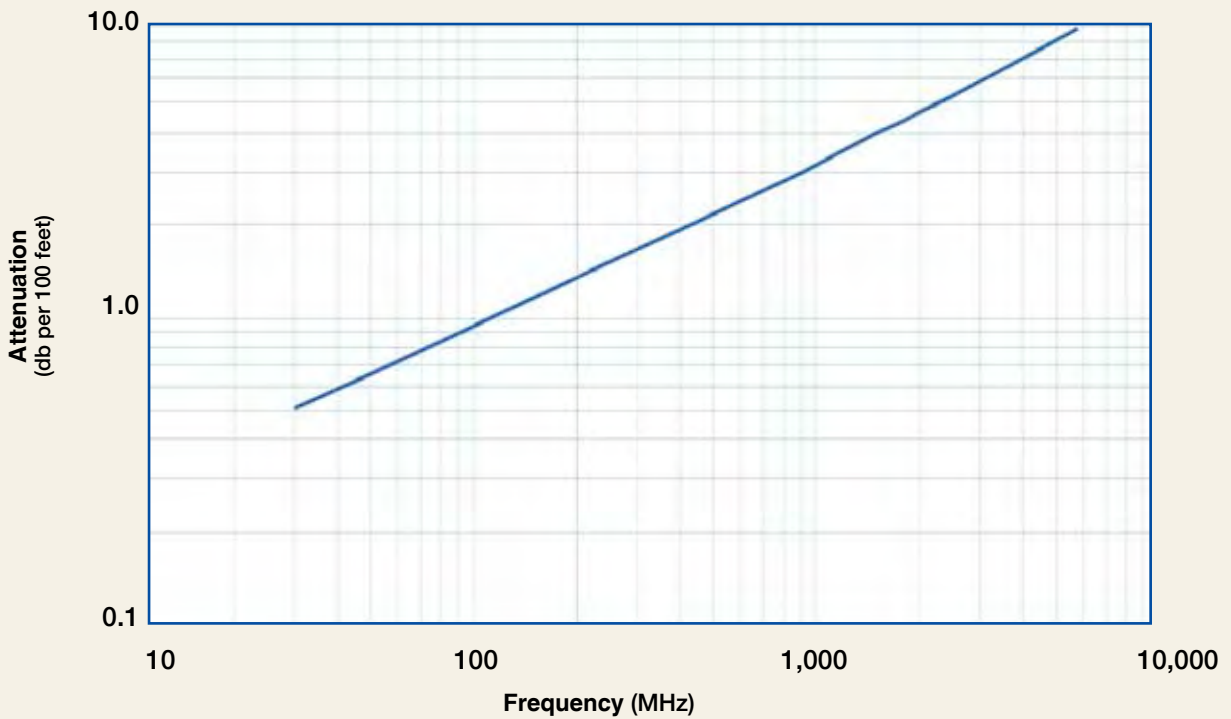

Frequency (MHz)	30	50	150	220	450	900	1500	1800	2000	2500	5800
Attenuation dB/100 ft	0.5	0.7	1.2	1.4	2.1	3.0	4.0	4.4	4.7	5.3	8.7
Attenuation dB/100 m	1.7	2.2	3.8	4.6	6.8	9.8	13.1	14.5	15.3	17.4	28.6
Avg. Power kW	4.59	3.53	2.00	1.64	1.12	0.77	0.58	0.52	0.49	0.43	0.26

**Calculate Attenuation =**

$(0.090660) \cdot \sqrt{\text{FMHz}} + (0.000312) \cdot \text{FMHz}$  (interactive calculator available at [http://www.timesmicrowave.com/cable\\_calculators](http://www.timesmicrowave.com/cable_calculators))

**Attenuation:**

VSWR=1.0; Ambient = +25°C (77°F)

**Power:**

VSWR=1.0; Ambient = +40°C; Inner Conductor = 100°C (212°F); Sea Level; dry air; atmospheric pressure; no solar loading

# LMR®-600-UF UltraFlex Communications Coax



Connectors		Part	Stock	VSWR**	Coupling	Inner Contact	Outer Contact	Finish*	Length	Width	Weight
Interface	Description	Number	Code	Freq. (GHz)	Nut	Attach	Attach	/Pin	in (mm)	in (mm)	lb (g)
1. 7-16 DIN Female	Straight Jack	TC-600-716-FC	3190-375	<1.25:1 (2.5)	NA	Solder	Clamp	S/S	1.1 (28)	1.00 (25.4)	0.249 (112.9)
2. 7-16 DIN Male	Straight Plug	TC-600-716-MC	3190-502	<1.25:1 (2.5)	Hex	Solder	Clamp	S/S	2.0 (51)	1.30 (33.0)	0.347 (157.4)
3. 7-16 DIN Male	Right Angle	TC-600-716M-RA	3190-395	<1.35:1 (2.5)	Hex	Solder	Crimp	S/S	1.4 (36)	1.40 (35.6)	0.354 (160.8)
4. N Male	Straight Plug	TC-600-NMC	3190-357*	<1.25:1 (2.5)	Hex	Solder	Clamp	S/G	2.1 (53)	0.92 (23.4)	0.208 (93.4)
5. N Male	Right Angle	TC-600-NMC-RA	3190-233	<1.35:1 (2.5)	Hex	Solder	Clamp	S/G	2.1 (53)	0.92 (23.4)	0.280 (117.9)
6. N Male	Right Angle	TC-600-NMH-RA-D	3190-2427	<1.35:1(6)	Hex	Solder	Crimp	A/G	1.8 (46.5)	1.62 (41.2)	0.185 (84.3)
7. N Male	Straight Plug	TC-600-NMH-75/50	3190-1610	<1.35:1 (6)	Hex	Solder	Crimp	N/G	2.1 (52.8)	0.91 (23.1)	0.130 (59.0)
8. TNC	Straight Plug	TC-600-TM-RP	3190-1064	<<1.35:1 (6)	Knurl	Solder	Crimp	N/G	1.6 (40.2)	0.68 (17.0)	0.090 (40.8)
9. TNC	Straight Plug	TC-600-TM-X	3190-2530	<1.25:1 (6)	Hex/Knurl	Solder	Crimp	A/G	2.3 (57.6)	0.75 (19.0)	0.100 (45.6)
10. BNC Male	Right Angle	TC-600-BM-RA	3190-2734	<1.30:1 (4)	Knurl	Solder	Crimp	A/G	1.8 (45.5)	1.54 (39.0)	0.164 (74.3)
11. N Female	Bulkhead Jack	TC-600-NF-BH	3190-589*	<1.25:1 (2.5)	NA	Solder	Crimp	S/G	2.4 (61)	0.88 (22.4)	0.195 (88.5)
12. N Female	Bulkhead Jack	TC-600-NFC-BH	3190-466	<1.25:1 (2.5)	NA	Solder	Clamp	S/G	2.2 (56)	0.94 (23.9)	0.214 (97.1)
13. UHF Male	Straight Plug	TC-600-UMC	3190-213	<1.25:1 (2.5)	Knurl	Solder	Clamp	S/G	1.7 (43)	0.88 (22.4)	0.198 (89.8)
14. N Male	Straight Plug	TC-600-NMH-X	3190-2628	<1.25:1 (8)	Hex/Knurl	Solder	Crimp	A/G	2.1 (53)	0.92 (23.4)	0.166 (75.3)
15. BNC Male	Right Angle	TC-600-BM-RA	3190-2734	<1.30:1 (4)	Knurl	Solder	Crimp	A/G	1.8 (45.5)	1.54 (39.0)	0.164 (74.3)

\* Finish metals: N=Nickel, S=Silver, G=Gold, SS=Stainless Steel, A=Alballoy \*\*VSWR spec based on 3 foot cable with a connector pair

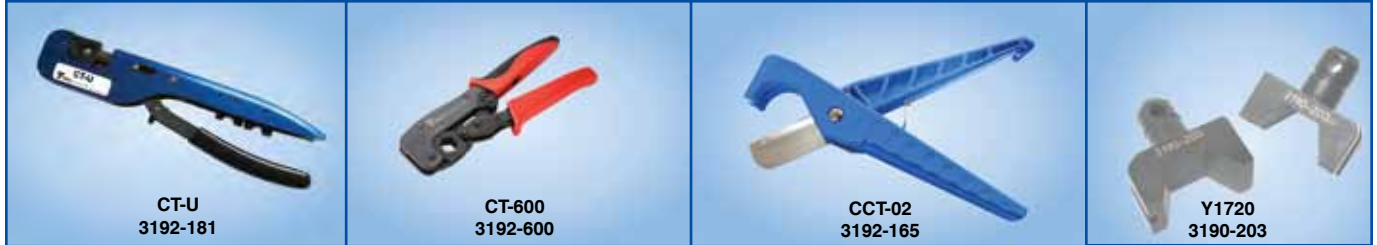

## Install Tools

Type	Part Number	Stock Code	Description
Crimp Tool	CT-U	3192-181	Crimp Handle (Dies Required)
Crimp Dies	Y1720	3190-203	.610" Hex Dies
Crimp Tool	CT-600	3192-170	Crimp tool for LMR-600 connectors
Cutting Tool	CCT-02	3192-165	Cable end flush cut tool
Replacement Blade	RB-01	3190-1609	Replacement blade for cutting tool



## Accessories

Type	Part Number	Stock Code	Description
Ground Kit	GK-S600TT	GK-S600TT	Standard Grounding Kit (each)
Hoisting Grip	HG-600T	HG-600T	Split/Laced Type (each)
Cold Shrink	CS-A600T	CS-A600T	Cable to Antenna Junction (each)
Cold Shrink	CS-60120T	CS-60120T	LMR-600 to -1200 Junction (each)
Cold Shrink	CS-60170T	CS-60170T	LMR-600 to -1700 Junction (each)
Standard Entry Port Cushion	SC-600T-3	SC-600T-3	Three Cables (each)
Standard Entry Panels	Full Range of Port Styles/Combinations Available		
Hanger Blocks	CB-600T	CB-600T	Dual Cable Support Block (kit of 10)
Hanger Block Supporting Hardware	Complete Range of Supporting Hardware & Adapters Available		

## LMR®-195-LLPL Flexible Low Loss Plenum Coax

### Ideal for...

- Indoor Plenum Feeder runs
- Drop in replacement for RG-142
- UL/NEC/CSA rated CMP/FT6
- Any wireless application (e.g. LMDS, MMDS, WLL, GPS, LMR, WLAN, WISP, WiMax, SCADA, Cellular, PCS, Paging) requiring an easily routed, low loss RF cable for in-building systems

• **LMR®-LLPL** is an indoor highly fire retardant cable intended specifically for runs within return air handling plenums (e.g. dropped ceilings, raised floors). It has a UL/NEC & CSA rating of 'CMP' and 'FT6' respectively.

• **Flexibility** and bendability are hallmarks of the LMR-LLPL cable design. The flexible outer conductor enables the tightest bend radius available for any cable of similar size and performance.

• **Low Loss** is another hallmark feature of LMR-LLPL. Size for size LMR has the lowest loss of any flexible cable and comparable loss to semirigid hard-line cables.

• **RF Shielding** is 50 dB greater than typical single shielded coax (40 dB). The multi-ply bonded foil outer conductor is rated conservatively at > 90 dB (i.e. >180 dB between two adjacent cables).

• **Weatherability:** LMR-LLPL cables are designed for indoor Plenum applications. Black jacketed LMR-LLPL versions can be supplied for applications that originate outdoors (e.g., rooftop) and subsequently enter the building.

• **Connectors:** A variety of connectors are available for LMR-LLPL cable, including the most common interface types. Most employ crimp outer attachment using standard hex crimp sizes.

• **Cable Assemblies:** All LMR-LLPL cable types are available as pre-terminated cable assemblies. Refer to the section on FlexTech for further details.

Part Description				
Part No.	Application	Jacket	Color	Stock Code
LMRR-195-LLPL	Indoor/Outdoor Plenum CMP/FT-6	FRPVC	Orange	54211



Construction Specifications			
Description	Material	In.	(mm)
Inner Conductor	Solid BC	0.037	(0.94)
Dielectric	Low density PTFE	0.113	(2.87)
Outer Conductor	Aluminum Tape	0.119	(3.02)
Overall Braid	Tinned Copper	0.142	(3.61)
Jacket	Orange FRPVC	0.195	(4.95)

Mechanical Specifications			
Performance Property	Units	US	(metric)
Bend Radius: installation	in. (mm)	0.5	(12.7)
Bend Radius: repeated	in. (mm)	2.0	(50.8)
Bending Moment	ft-lb (N-m)	0.1	(0.14)
Weight	lb/ft (kg/m)	0.021	(0.03)
Tensile Strength	lb (kg)	40	(18.2)
Flat Plate Crush	lb/in. (kg/mm)	10	(0.18)

Environmental Specifications		
Performance Property	'F	'C
Installation Temperature Range	+23/+167	-5/+75
Storage Temperature Range	+23/+167	-5/+75
Operating Temperature Range	+23/+167	-5/+75

Electrical Specifications			
Performance Property	Units	US	(metric)
Velocity of Propagation	%	76	
Dielectric Constant	NA	1.73	
Time Delay	nS/ft (nS/m)	1.34	(4.40)
Impedance	ohms	50	
Capacitance	pF/ft (pF/m)	26.7	(87.6)
Inductance	uH/ft (uH/m)	0.067	(0.22)
Shielding Effectiveness	dB	>90	
DC Resistance			
Inner Conductor	ohms/1000ft (/km)	7.6	(24.9)
Outer Conductor	ohms/1000ft (/km)	4.9	(16.1)
Voltage Withstand	Volts DC	1000	
Jacket Spark	Volts RMS	3000	
Peak Power	kW	2.5	

Attenuation vs. Frequency (typical)

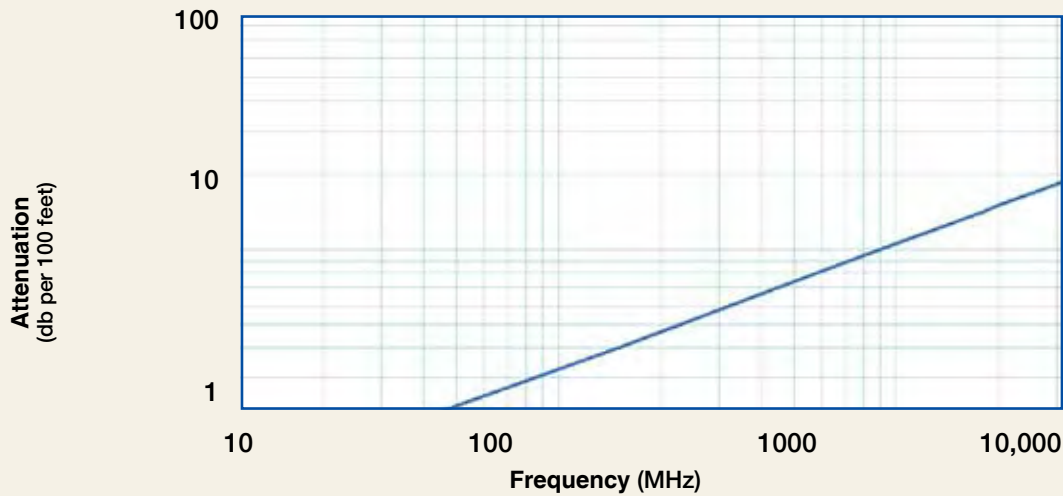

Frequency (MHz)	30	50	150	220	450	900	1500	1800	2000	2500	3400	5800	8000
Attenuation dB/100 ft	2.0	2.5	4.4	5.3	7.8	10.9	14.1	15.4	16.3	18.3	21.4	28.2	35.7
Attenuation dB/100 m	6.4	8.3	14.4	17.5	25.1	35.6	46.2	50.7	53.5	60.0	70.2	92.5	117.1
Avg. Power kW	0.70	0.54	0.31	0.26	0.18	0.12	0.10	0.09	0.08	0.07	0.06	0.05	0.04

Calculate Attenuation =

$(0.356297) \cdot \sqrt{\text{FMHz}} + (0.000183) \cdot \text{FMHz}$  (interactive calculator available at [http://www.timesmicrowave.com/cable\\_calculators](http://www.timesmicrowave.com/cable_calculators))

Attenuation:

VSWR=1.0 ; Ambient = +25°C (77°F)

Power:

VSWR= 1.0; Ambient = +40°C; Jacket = +75°C (167°F); Sea Level; dry air; atmospheric pressure; no solar loading

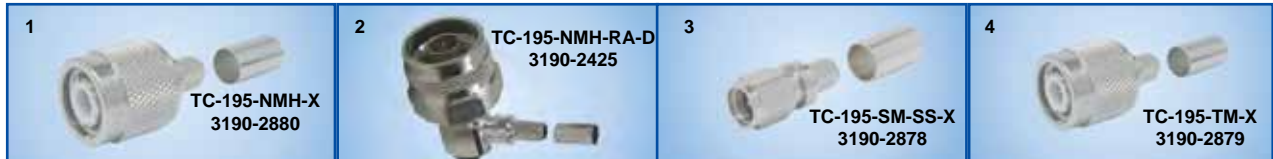

Connectors		Part Number	Stock Code	VSWR** Freq. (GHz)	Coupling Nut	Inner Contact Attach	Outer Contact Attach	Finish* Body /Pin	Length in (mm)	Width in (mm)	Weight lb (g)
1. N male	Straight Plug	TC-195-NMH-X	3190-2880	<1.25:1 (2.5)	Knurl	Solder	Crimp	S/G	1.5 (38.1)	0.75 (19.1)	0.073 (33.1)
2. N male	Right Angle	TC-195-NMH-RA-D	3190-2425	<1.35:1 (6)	Hex/Knurl	Solder	Crimp	A/G	1.3 (32.1)	1.19 (30.1)	0.083 (37.5)
3. SMA male	Straight Plug	TC-195-SM-SS-X	3190-2878	<1.25:1 (2.5)	Hex	Solder	Crimp	SS/G	1.0 (25.4)	0.32 (8.1)	0.015 (6.8)
4. TNC male	Straight Plug	TC-195-TM-X	3190-2879	<1.25:1 (2.5)	Knurl	Solder	Crimp	S/G	1.4 (35.6)	0.59 (15.0)	0.045 (20.4)

(20.4)



Install Tools



Type	Part Number	Stock Code	Description
Crimp Tool	CT-240/200/195/100	3190-667	Crimp tool for LMR-100, 195, 200 and 240 connectors
Deburr Tool	DBT-U	3192-001	Removes center conductor rough edges
Cutting Tool	CCT-02	3192-165	Cable end flush cut tool
Replacement Blade	RB-02	3192-166	Replacement blade for cutting tool
Strip Tool	CST-195/200	3192-102	Combination prep tool for LMR-195 & 200
Replacement Blade Kit	RB-CST	3192-086	Replacement blade kit for all strip tools





# LMR<sup>®</sup>-200-LLPL Flexible Low Loss Plenum Coax

## Ideal for...

- Indoor Plenum Feeder runs
- UL/NEC/CSA rated CMP/FT6
- Any wireless application (e.g. LMDS, MMDS, WLL, GPS, LMR, WLAN, WISP, WiMax, SCADA, Cellular, PCS, Paging) requiring an easily routed, low loss RF cable for in-building systems



Part Description				
Part No.	Application	Jacket Color		Stock Code
LMR-200-LLPL	Indoor/Outdoor Plenum CMP/FT6	FRPVC	Orange	54058

Environmental Specifications			
Performance Property	°F		°C
Installation Temperature Range	+23/+167		-5/+75
Storage Temperature Range	+23/+167		-5/+75
Operating Temperature Range	+23/+167		-5/+75

Construction Specifications			
Description	Material	In.	(mm)
Inner Conductor	Solid Bare Copper	0.040	(1.02)
Dielectric	Low density PTFE	0.118	(3.00)
Outer Conductor	Aluminum Tape	0.123	(3.12)
Overall Braid	Tinned Copper	0.146	(3.71)
Jacket	Orange FRPVC	0.195	(4.95)

Mechanical Specifications			
Performance Property	Units	US	(metric)
Bend Radius: installation	in. (mm)	0.5	(12.7)
Bend Radius: repeated	in. (mm)	2.0	(50.8)
Bending Moment	ft-lb (N-m)	0.2	(0.27)
Weight	lb/ft (kg/m)	0.032	(0.05)
Tensile Strength	lb (kg)	30	(13.6)
Flat Plate Crush	lb/in. (kg/mm)	65	(1.16)

Electrical Specifications			
Performance Property	Units	US	(metric)
Velocity of Propagation	%	76	
Dielectric Constant	NA	1.73	
Time Delay	nS/ft (nS/m)	1.34	(4.40)
Impedance	ohms	50	
Capacitance	pF/ft (pF/m)	26.7	(87.6)
Inductance	uH/ft (uH/m)	0.067	(0.22)
Shielding Effectiveness	dB	>90	
DC Resistance			
Inner Conductor	ohms/1000ft (/km)	6.5	(21.3)
Outer Conductor	ohms/1000ft (/km)	4.9	(16.1)
Voltage Withstand	Volts DC	1000	
Jacket Spark	Volts RMS	3000	
Peak Power	kW	2.5	

Attenuation vs. Frequency (typical)

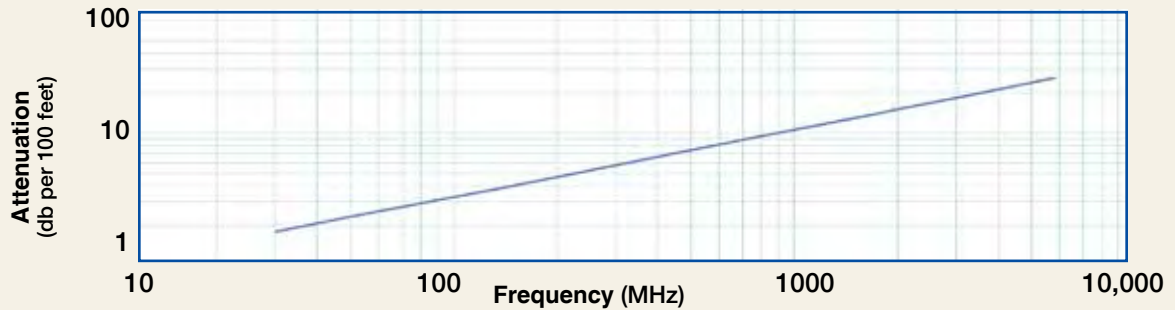

Frequency (MHz)	30	50	150	220	450	900	1500	1800	2000	2500	3400	5800	8000
Attenuation dB/100 ft	1.8	2.3	4.1	4.9	7.1	10.0	13.0	14.3	15.1	16.0	19.8	26.1	31.3
Attenuation dB/100 m	5.9	7.7	13.3	16.1	23.2	32.9	42.7	48.9	49.5	55.5	65.0	85.7	102.8
Avg. Power kW	0.77	0.59	0.34	0.28	0.19	0.14	0.11	0.10	0.09	0.08	0.07	0.05	0.06

Calculate Attenuation =  $(0.329080) \cdot \sqrt{\text{FMHz}} + (0.00018) \cdot \text{FMHz}$  (interactive calculator available at [http://www.timesmicrowave.com/cable\\_calculators](http://www.timesmicrowave.com/cable_calculators))  
 VSWR = 1.0, Ambient = +40C; Jacket = +75C (167F); Sea Level; dry air; atmospheric pressure; no solar loading



**Connectors**

Interface	Description	Part Number	Stock Code	VSWR** Freq. (GHz)	Coupling Nut	Inner Contact Attach	Outer Contact Attach	Finish* Body /Pin	Length in (mm)	Width in (mm)	Weight lb (g)
1. BNC Male	Straight Plug	TC-200-BM	3190-225	<1.25:1 (2.5)	Knurl	Solder	Crimp	S/G	1.7 (43.2)	0.56 (14.2)	0.045 (20.4)
2. Mini-UHF	Straight Plug	TC-200-MUHF	3190-444	<1.25:1 (2.5)	Knurl	Solder	Crimp	NG	1.1 (27.9)	0.45 (11.4)	0.015 (6.8)
3. N Male	Straight Plug	TC-200-NM	3190-224	<1.25:1 (2.5)	Knurl	Solder	Crimp	S/G	1.5 (38.1)	0.75 (19.1)	0.073 (33.1)
4. N Male	Reverse Polarity	TC-200-NM-RP	3190-959	<1.25:1 (2.5)	Knurl	Solder	Crimp	N/G	1.5 (38.0)	0.75 (19.1)	0.073 (33.1)
5. TNC Male	Straight Plug	TC-200-TMC	3190-240	<1.25:1 (2.5)	Knurl	Solder	Clamp	S/G	1.7 (43.2)	0.59 (15.0)	0.045 (20.4)
6. TNC Female	Straight Jack	TC-200-TF	3190-263	<1.25:1 (2.5)	NA	Solder	Crimp	N/G	1.3 (33.0)	0.57 (14.5)	0.033 (15.0)
7. SMA-Male	Straight plug	TC-200-SM	3190-612	<1.25:1 (8)	Hex	Solder	Crimp	SS/G	1.0 (25.4)	0.32 (8.1)	0.015 (6.8)
8. SMA-Rev. Polarity	Straight Plug	TC-200-SM-RP	3190-327	<1.25:1 (2.5)	Hex	Solder	Crimp	SS/G	1.0 (25.4)	0.32 (8.1)	0.015 (6.8)

\* Finish metals: N=Nickel, S=Silver, G=Gold, SS=Stainless Steel, A=Alballoy \*\*VSWR spec based on 3 foot cable with a connector pair

**Hardware Accessories**



Type	Part Number	Stock Code	Description
Ground Kit	GK-S200TT	GK-S200TT	Standard Ground Kit (each)



**Install Tools**

Type	Part Number	Stock Code	Description
Crimp Tool	CT-240/200/195/100	3190-667	Crimp tool for LMR-100, 195, 200 and 240 connectors
Deburr Tool	DBT-U	3192-001	Removes center conductor rough edges
Cutting Tool	CCT-02	3192-165	Cable end flush cut tool
Strip Tool	CST-195/200	3192-102	Combination prep tool for LMR-195/200
Replacement Blade	RB-02	3192-166	Replacement blade for cutting tool
Replacement Blade Kit	RB-CST	3192-086	Replacement Kit for all CST strip tools

# LMR<sup>®</sup>-240-LLPL Flexible Low Loss Plenum Coax

Ideal for...

- Indoor Plenum Feeder runs
- UL/NEC/CSA rated CMP/FT6
- Any wireless application (e.g. LMDS, MMDS, WLL, GPS, LMR, WLAN, WISP, WiMax, SCADA, Cellular, PCS, Paging) requiring an easily routed, low loss RF cable for in-building systems



Part Description				
Part No.	Application	Jacket	Color	Stock Code
LMR-240-LLPL	Indoor/Outdoor Plenum CMP/FT6	FRPVC	Orange	54059

Environmental Specifications			
Performance Property	°F	°C	
Installation Temperature Range	+23/+167	-5/+75	
Storage Temperature Range	+23/+167	-5/+75	
Operating Temperature Range	+23/+167	-5/+75	

Construction Specifications			
Description	Material	In.	(mm)
Inner Conductor	Solid Bare Copper	0.051	(1.30)
Dielectric	Low density PTFE	0.150	(3.81)
Outer Conductor	Aluminum Tape	0.155	(3.94)
Overall Braid	Tinned Copper	0.178	(4.52)
Jacket	Orange FRPVC	0.240	(6.10)

Mechanical Specifications			
Performance Property	Units	US	(metric)
Bend Radius: installation	in. (mm)	0.75	(19.1)
Bend Radius: repeated	in. (mm)	2.5	(63.5)
Bending Moment	ft-lb (N-m)	0.25	(0.34)
Weight	lb/ft (kg/m)	0.047	(0.07)
Tensile Strength	lb (kg)	60	(27.22)
Flat Plate Crush	lb/in. (kg/mm)	85	(1.52)

Electrical Specifications			
Performance Property	Units	US	(metric)
Velocity of Propagation	%	76	
Dielectric Constant	NA	1.73	
Time Delay	nS/ft (nS/m)	1.34	(4.40)
Impedance	ohms	50	
Capacitance	pF/ft (pF/m)	26.7	(87.6)
Inductance	uH/ft (uH/m)	0.067	(0.22)
Shielding Effectiveness	dB	>90	
DC Resistance			
Inner Conductor	ohms/1000ft (/km)	4.0	(13.1)
Outer Conductor	ohms/1000ft (/km)	3.9	(12.8)
Voltage Withstand	Volts DC	1500	
Jacket Spark	Volts RMS	5000	
Peak Power	kW	5.6	

Attenuation vs. Frequency (typical)

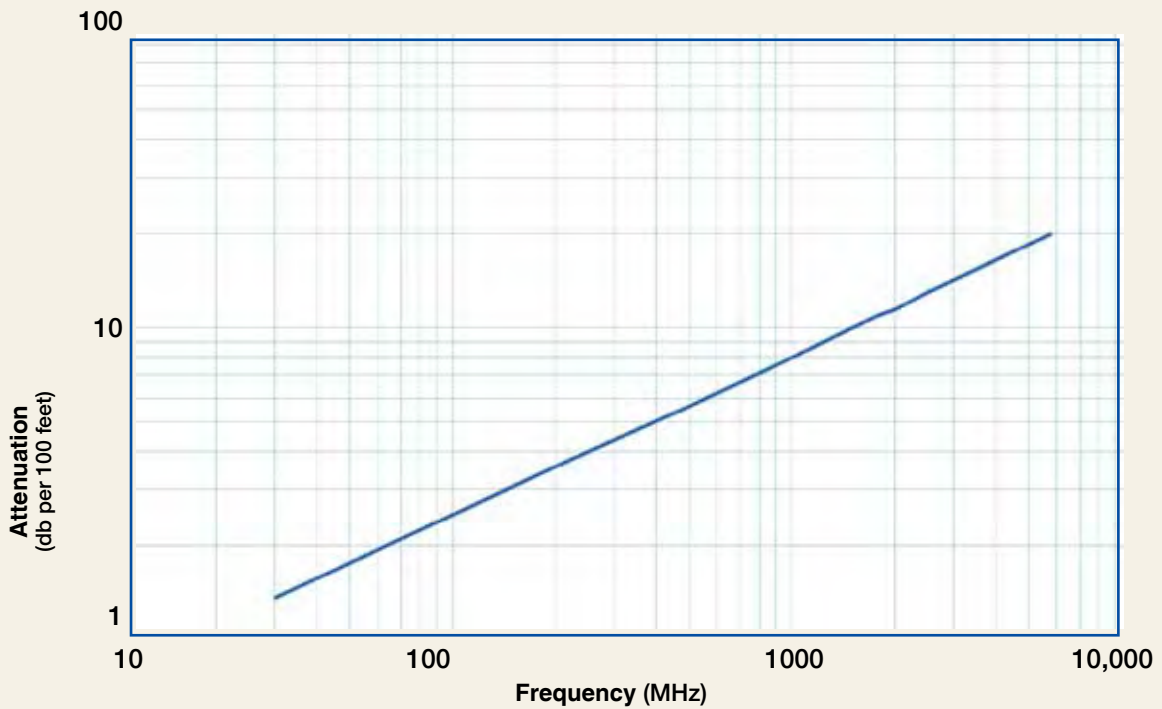

Frequency (MHz)	30	50	150	220	450	900	1500	1800	2000	2500	3400	5800	8000
Attenuation dB/100 ft	1.4	1.8	3.1	3.7	5.4	7.6	9.9	10.9	11.5	12.9	15.1	20.0	24.3
Attenuation dB/100 m	4.5	5.8	10.1	12.2	17.6	25.0	32.5	35.7	37.7	42.3	49.6	65.6	79.7
Avg. Power kW	1.18	0.91	0.52	0.43	0.30	0.21	0.16	0.15	0.14	0.12	0.10	0.08	0.08

**Calculate Attenuation =**  
 $(0.248520) \sqrt{\text{FMHz}} + (0.000183) \cdot \text{FMHz}$  (interactive calculator available at [http://www.timesmicrowave.com/cable\\_calculators](http://www.timesmicrowave.com/cable_calculators))  
**Attenuation:**  
 VSWR=1.0; Ambient = +25°C (77°F)  
**Power:**  
 VSWR=1.0; Ambient = +40°C; Jacket = +75°C (167°F); Sea Level; dry air; atmospheric pressure; no solar loading

# LMR<sup>®</sup>-240-LLPL Flexible Low Loss Plenum Coax

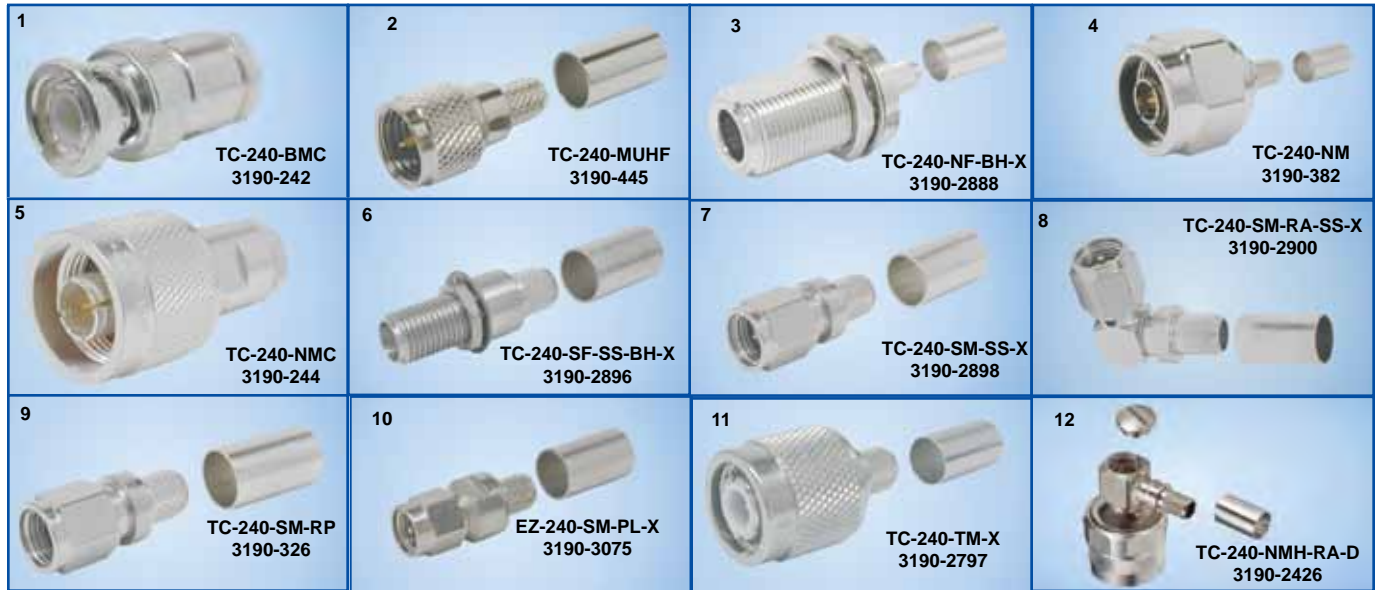

Connectors		Part Number	Stock Code	VSWR**	Coupling	Inner Contact Attach	Outer Contact Attach	Finish*	Length	Width	Weight
Interface	Description			Freq. (GHz)	Nut			Body /Pin	in (mm)	in (mm)	lb (g)
1. BNC Male	Straight Plug	TC-240-BMC	3190-242	<1.25:1 (2.5)	Knurl	Solder	Clamp	S/G	1.7 (43)	0.56 (14.2)	0.040 (18.1)
2. Mini-UHF	Straight Plug	TC-240-MUHF	3190-445	<1.25:1 (2.5)	Knurl	Solder	Crimp	N/G	1.1 (28)	0.45 (11.4)	0.014 (6.4)
3. N Female	Bulkhead Jack	TC-240-NF-BH-X	3190-2888	<1.25 (2.5)	NA	Solder	Crimp	A/G	1.7 (44)	0.88 (22.2)	0.115 (52.2)
4. N Male	Straight Plug	TC-240-NM	3190-382	<1.25:1 (2.5)	Hex	Solder	Crimp	N/S	1.5 (38)	0.75 (19.1)	0.086 (39.0)
5. N Male	Straight Plug	TC-240-NMC	3190-244	<1.25:1 (2.5)	Knurl	Solder	Clamp	S/G	1.5 (38)	0.75 (19.1)	0.082 (37.2)
6. SMA Female	Bulkhead Jack	TC-240-SF-SS-BH-X	3190-2896	<1.25:1 (2.5)	NA	Solder	Crimp	SS/G	1.1 (29)	0.31 (7.9)	0.019 (8.6)
7. SMA Male	Straight Plug	TC-240-SM-SS-X	3190-2898	<1.25:1 (10)	Hex	Solder	Crimp	SS/G	1.0 (25)	0.32 (8.1)	0.016 (7.3)
8. SMA Male	Right Angle	TC-240-SM-RA-SS-X	3190-2900	<1.35:1 (6)	Hex	Solder	Crimp	SS/G	0.8 (20)	0.65 (16.5)	0.019 (8.6)
9. SMA Male	Rev. Polarity	TC-240-SM-RP	3190-326	<1.25:1 (2.5)	Hex	Solder	Crimp	SS/G	1.0 (25)	0.32 (8.1)	0.016 (7.3)
10. SMA Male	Straight Plug	EZ-240-SM-PL-X	3190-3075	<1.25:1 (6)	Hex	Spring Finger	Crimp	A/G	1.0 (25.4)	0.32 (8.1)	0.016 (PL)
11. TNC Male	Straight Plug	TC-240-TM-X	3190-2797	<1.25:1 (2.5)	Knurl	Solder	Crimp	N/S	1.7 (43)	0.59 (15.0)	0.043 (19.5)
12. N Male	Right Angle	TC-240-NMH-RA-D	3190-2426	<1.35:1 (6)	Hex/Knurl	Solder	Crimp	A/G	1.2 (32.4)	1.22 (31.0)	0.091 (41.7)

\* Finish metals: N=Nickel, S=Silver, G=Gold, SS=Stainless Steel, A=Albally \*VSWR spec based on 3 foot cable with a connector pair



## Hardware Accessories

Type	Part Number	Stock Code	Description
Ground Kit	GK-S240TT	GK-S240TT	Standard Ground Kit (each)



## Install Tools

Type	Part Number	Stock Code	Description
Crimp Tool	CT-240/200/195/100	3190-667	Crimp tool for LMR-100, 195, 200 and 240 connectors
Strip Tool	CST-240A	3192-152	Prep tool for LMR-240 connectors
Deburr Tool	DBT-U	3192-001	Removes center conductor rough edges
Cutting Tool	CCT-02	3192-165	Cable end flush cut tool
Replacement Blade	RB-02	3192-166	Replacement blade for cutting tool
Replacement Blade Kit	RB-CST	3192-086	Replacement kit for all CST strip tools
Weather Seal Boots	WSB-240	3109-400	Weather seal/strain relief boots (10 pk) for use with most popular LMR-240-X series connectors

## LMR<sup>®</sup>-300-LLPL Flexible Low Loss Plenum Coax

### Ideal for...

- Indoor Plenum Feeder runs
- UL/NEC/CSA rated CMP/FT6
- Any wireless application (e.g. LMDS, MMDS, WLL, GPS, LMR, WLAN, WISP, WiMax, SCADA, Cellular, PCS, Paging) requiring an easily routed, low loss RF cable for in-building systems



Part Description				
Part Number	Application	Jacket Color		Stock Code
LMR-300-LLPL	Indoor/Outdoor Plenum CMP/FT6	FRPVC Orange		54175

Environmental Specifications			
Performance Property		°F	°C
Installation Temperature Range		+23/+167	-5/+75
Storage Temperature Range		+23/+167	-5/+75
Operating Temperature Range		+23/+167	-5/+75

Construction Specifications			
Description	Material	In.	(mm)
Inner Conductor	Solid Bare Copper	0.063	(1.60)
Dielectric	Low density PTFE	0.190	(4.83)
Outer Conductor	Aluminum Tape	0.196	(4.98)
Overall Braid	Tinned Copper	0.225	(5.72)
Jacket	Orange FRPVC	0.300	(7.62)

Mechanical Specifications			
Performance Property	Units	US	(metric)
Bend Radius: installation	in. (mm)	0.88	(22.2)
Bend Radius: repeated	in. (mm)	3.0	(76.2)
Bending Moment	ft-lb (N-m)	0.38	(0.52)
Weight	lb/ft (kg/m)	0.055	(0.08)
Tensile Strength	lb (kg)	120	(54.5)
Flat Plate Crush	lb/in. (kg/mm)	30	(0.54)

Electrical Specifications			
Performance Property	Units	US	(metric)
Velocity of Propagation	%	76	
Dielectric Constant	NA	1.73	
Time Delay	nS/ft (nS/m)	1.34	(4.40)
Impedance	ohms	50	
Capacitance	pF/ft (pF/m)	26.7	(87.6)
Inductance	uH/ft (uH/m)	0.067	(0.22)
Shielding Effectiveness	dB	>90	
DC Resistance			
Inner Conductor	ohms/1000ft (/km)	2.61	(8.6)
Outer Conductor	ohms/1000ft (/km)	2.21	(7.3)
Voltage Withstand	Volts DC	2000	
Jacket Spark	Volts RMS	5000	
Peak Power	kW	10	

Attenuation vs. Frequency (typical)

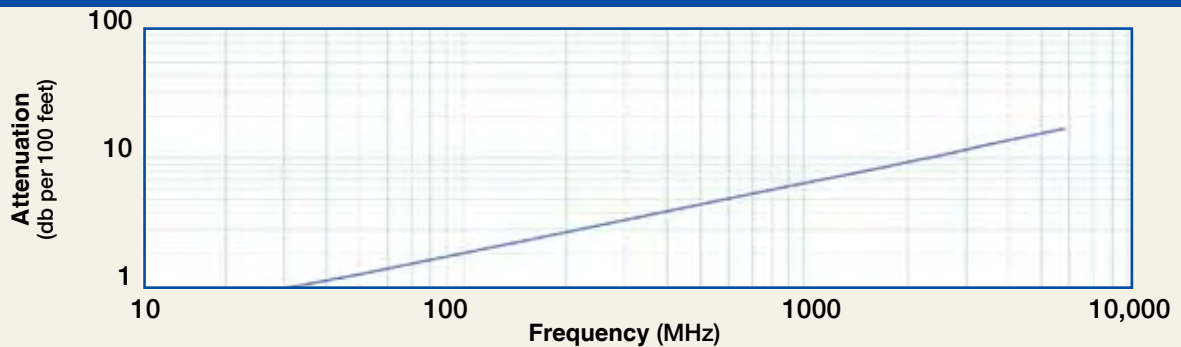

Frequency (MHz)	30	50	150	220	450	900	1500	1800	2000	2500	3400	5800	8000
Attenuation dB/100 ft	1.1	1.4	2.5	3.0	4.3	6.2	8.1	8.9	9.4	10.5	12.3	16.4	19.8
Attenuation dB/100 m	3.6	4.7	8.2	9.9	14.3	20.3	26.4	29.1	30.7	34.5	40.5	53.7	65.0
Avg. Power kW	1.72	1.33	0.77	0.63	0.44	0.31	0.24	0.21	0.20	0.18	0.15	0.11	0.11

Calculate Attenuation =  $(0.200950) \cdot \sqrt{\text{FMHz}} + (0.000183) \cdot \text{FMHz}$  (interactive calculator available at [http://www.timesmicrowave.com/cable\\_calculators](http://www.timesmicrowave.com/cable_calculators))  
 Attenuation: VSWR=1.0; Ambient = +25°C (77°F) Power: VSWR=1.0; Ambient = +40°C; Jacket = +75°C (167°F);  
 Sea Level; dry air; atmospheric pressure; no solar loading



Connectors

Interface	Description	Part Number	Stock Code	VSWR Freq.	Coupling (GHz)	Nut	Inner Contact Attach	Outer Contact Attach	Finish* /Pin	Length in	Length (mm)	Width in	Width (mm)	Weight lb	Weight (g)
1. SMA Male	Straight Plug	TC-300-SM	3190-501	<1.25:1	(2.5)	Hex	Solder	Crimp	SS/G	1.0	(25)	0.35	(8.9)	0.018	(8.2)
2. SMA Female	Bulkhead Jack	TC-300-SF-BH	3190-590	<1.25:1	(2.5)	NA	Solder	Crimp	SS/G	1.1	(28)	0.31	(7.9)	0.022	(10.0)
3. TNC Male	Straight Plug	TC-300-TM	3190-500	<1.25:1	(2.5)	Knurl	Solder	Crimp	N/S	1.7	(43)	0.59	(15.0)	0.050	(22.7)
4. N Male	Right Angle	TC-300-NMH-RA-D	3190-2761	<1.30:1	(2.5)	Hex/Knurl	Solder	Crimp	N/S	1.4	(35)	1.41	(35.8)	0.130	(59.0)

\* Finish metals: N=Nickel, S=Silver, G=Gold, SS=Stainless Steel, A=Alballoy \*\*VSWR spec based on 3 foot cable with a connector pair



Hardware Accessories

Type	Part Number	Stock Code	Description
Ground Kit	GK-S300TT	GK-S300TT	Standard Ground Kit (each)



Install Tools

Type	Part Number	Stock Code	Description
Crimp Tool	CT-400/300	3190-666	Crimp tool for LMR 300 connectors
Deburr Tool	DBT-U	3192-001	Removes center conductor rough edges
Cutting Tool	CCT-02	3192-165	Cable end flush cut tool
Strip Tool	CST-300	3192-084	Combination prep tool for LMR-300
Replacement Blade	RB-02	3192-166	Replacement blade for cutting tool
Replacement Blade Kit	RB-CST	3192-086	Replacement blade kit for all strip tools





## LMR<sup>®</sup>-400-LLPL Flexible Low Loss Plenum Coax

### Ideal for...

- Indoor Plenum Feeder runs
- UL/NEC/CSA rated CMP/FT6
- Any wireless application (e.g. LMDS, MMDS, WLL, GPS, LMR, WLAN, WISP, WiMax, SCADA, Cellular, PCS, Paging) requiring an easily routed, low loss RF cable for in-building systems



Part Description				
Part Number	Application	Jacket	Color	Stock Code
LMR-400-LLPL	Indoor/Outdoor Plenum CMP/FT6	FRPVC	Orange	54070

Environmental Specifications			
Performance Property	°F	°C	
Installation Temperature Range	+23/+167	-5/+75	
Storage Temperature Range	+23/+167	-5/+75	
Operating Temperature Range	+23/+167	-5/+75	

Construction Specifications			
Description	Material	In.	(mm)
Inner Conductor	Solid BCCAI	0.095	(2.41)
Dielectric	Low density PTFE	0.285	(7.24)
Outer Conductor	Aluminum Tape	0.291	(7.39)
Overall Braid	Tinned Copper	0.320	(8.13)
Jacket	Orange FRPVC	0.405	(10.29)

Mechanical Specifications			
Performance Property	Units	US	(metric)
Bend Radius: installation	in. (mm)	1.00	(25.4)
Bend Radius: repeated	in. (mm)	4.0	(101.6)
Bending Moment	ft-lb (N-m)	0.5	(0.68)
Weight	lb/ft (kg/m)	0.114	(0.17)
Tensile Strength	lb (kg)	120	(54.5)
Flat Plate Crush	lb/in. (kg/mm)	185	(3.31)

Electrical Specifications			
Performance Property	Units	US	(metric)
Velocity of Propagation	%	76	
Dielectric Constant	NA	1.73	
Time Delay	nS/ft (nS/m)	1.34	(4.40)
Impedance	ohms	50	
Capacitance	pF/ft (pF/m)	26.7	(87.6)
Inductance	uH/ft (uH/m)	0.067	(0.22)
Shielding Effectiveness	dB	>90	
DC Resistance			
Inner Conductor	ohms/1000ft (/km)	1.8	(5.9)
Outer Conductor	ohms/1000ft (/km)	1.65	(5.4)
Voltage Withstand	Volts DC	2500	
Jacket Spark	Volts RMS	8000	
Peak Power	kW	16	

Attenuation vs. Frequency (typical)

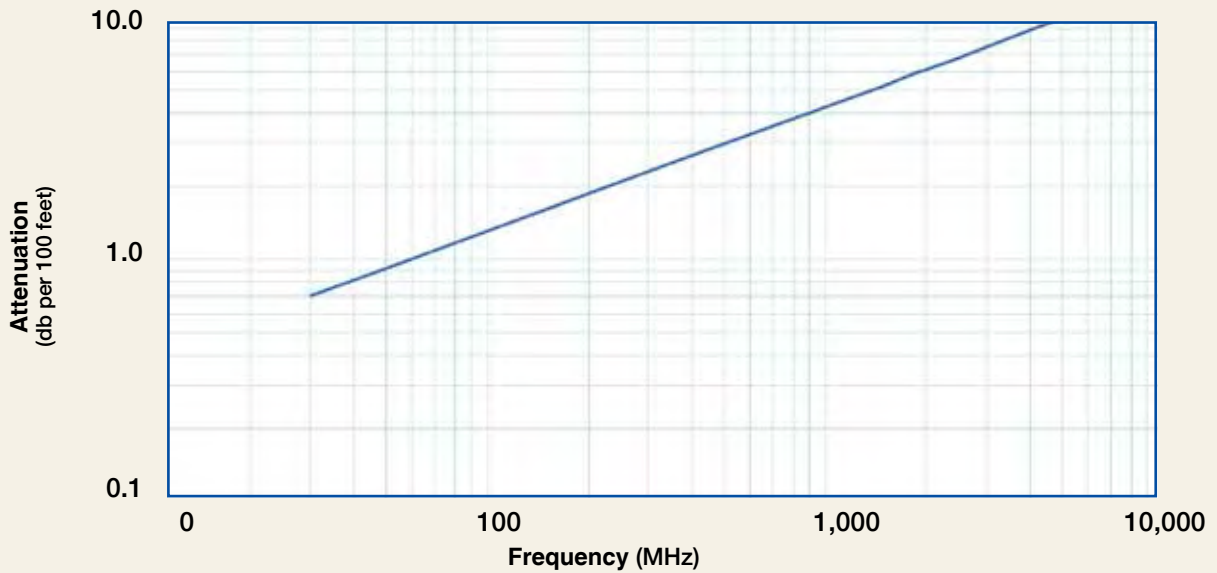

Frequency (MHz)	30	50	150	220	450	900	1500	1800	2000	2500	3400	5800	8000
Attenuation dB/100 ft	0.7	0.9	1.6	1.9	2.8	4.0	5.2	5.7	6.1	6.8	8.0	10.7	13.0
Attenuation dB/100 m	2.3	3.0	5.3	6.4	9.2	13.2	17.1	18.9	19.9	22.4	26.4	35.1	42.7
Avg. Power kW	3.33	2.57	1.48	1.22	0.84	0.59	0.45	0.41	0.39	0.34	0.29	0.22	0.17

**Calculate Attenuation =**  
 $(0.129140) \cdot \sqrt{\text{FMHz}} + (0.000150) \cdot \text{FMHz}$  (interactive calculator available at [http://www.timesmicrowave.com/cable\\_calculators](http://www.timesmicrowave.com/cable_calculators))  
**Attenuation:**  
 VSWR=1.0 ; Ambient = +25°C (77°F)  
**Power:**  
 VSWR=1.0; Ambient = +40°C; Jacket = +75°C (167°F); Sea Level; dry air; atmospheric pressure; no solar loading

# LMR<sup>®</sup>-400-LLPL Flexible Low Loss Plenum Coax

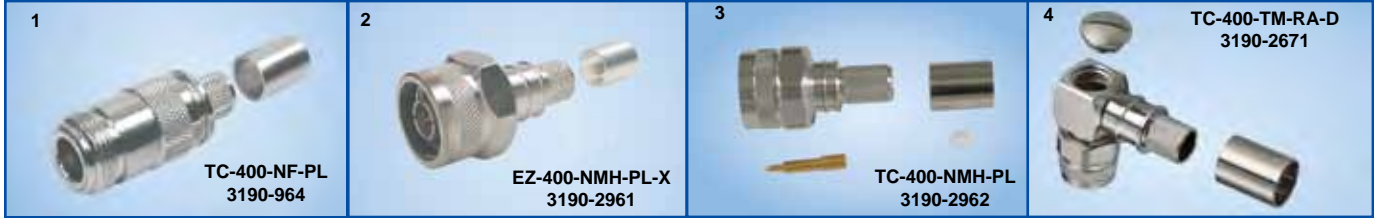

Connectors		Part Number	Stock Code	VSWR**	Coupling Nut	Inner Contact Attach	Outer Contact Attach	Finish* Body /Pin	Length in (mm)	Width in (mm)	Weight lb (g)
1. N Female	Straight Jack	TC-400-NF-PL	3190-964	<1.25:1 (2.5)	NA	Solder	Crimp	N/G	1.8 (45)	0.66 (16.8)	0.105 (47.6)
2. N Male	Straight Plug	EZ-400-NMH-PL-X	3190-2961	<1.25:1 (2.5)	Hex/Knurl	Spring Finger	Crimp	A/G	1.5 (38)	0.89 (22.6)	0.113 (51.3)
3. N Male	Straight Plug	TC-400-NMH-PL	3190-2962	<1.25:1 (2.5)	Hex/Knurl	Solder	Crimp	S/G	1.5 (38)	0.89 (22.6)	0.113 (51.3)
4. TNC Male	Right Angle	TC-400-TM-RA-D	3190-2671	<1.35:1 (6)	Hex/Knurl	Solder	Crimp	A/G	1.2 (30)	1.48 (37.6)	0.110 (50.0)

\* Finish metals: N=Nickel, S=Silver, G=Gold, SS=Stainless Steel, A=Alballoy \*\*VSWR spec based on 3 foot cable with a connector pair



## Hardware Accessories

Type	Part Number	Stock Code	Description
Ground Kit	GK-S400TT	GK-S400TT	Standard Grounding Kit (each)
Hoisting Grip	HG-400T	HG-400T	Laced Type (each)
Weather Seal Boots	WSB-400	3109-394	Weather seal/strain relief boots (10pk) for use with most popular LMR-400-X series connectors



## Install Tools

Type	Part Number	Stock Code	Description
Crimp Tool	CT-U	3192-181	Crimp Handle
Crimp Dies	Y1719	3190-202	.429" Hex Dies
Crimp Tool	CT-400/300	3190-666	Crimp tool for LMR 400 connectors
Crimp Rings	CR-400	3190-830	Crimp rings for TC/EZ-400 connectors (package of 10)
Strip Tool	CST-400	3192-004	Combination prep tool for LMR-400 crimp and clamp connectors
Mid-Span Strip Tool	GST-400	3190-2174	For ground strap attachment
Deburr Tool	DBT-U	3192-001	Removes center conductor rough edges
Cutting Tool	CCT-02	3192-165	Cable end flush cut tool
Replacement Blade	RB-02	3192-166	Replacement blade for cutting tool
Replacement Blade Kit	RB-CST	3192-086	Replacement kit for all CST strip tools
Tool Kit	TK-400EZ	3190-1601	Tool kit for LMR-400 crimp/clamp connectors (includes CCT-02, CST-400, CT-400/300, Tool Pouch)

# LMR<sup>®</sup>-500-LLPL Flexible Low Loss Plenum Coax

Ideal for...

- Indoor Plenum Feeder runs
- UL/NEC/CSA rated CMP/FT6
- Any wireless application (e.g. LMDS, MMDS, WLL, GPS, LMR, WLAN, WISP, WiMax, SCADA, Cellular, PCS, Paging) requiring an easily routed, low loss RF cable for in-building systems



Part Description				
Part Number	Application	Jacket	Color	Stock Code
LMR-500-LLPL	Indoor/Outdoor Plenum CMP/FT6	FRPVC	Orange	54060

Electrical Specifications			
Performance Property	Units	US	(metric)
Velocity of Propagation	%	76	
Dielectric Constant	NA	1.73	
Time Delay	nS/ft (nS/m)	1.34	(4.40)
Impedance	ohms	50	
Capacitance	pF/ft (pF/m)	26.7	(87.6)
Inductance	uH/ft (uH/m)	0.067	(0.22)
Shielding Effectiveness	dB	>90	
DC Resistance			
Inner Conductor	ohms/1000ft (/km)	1.09	(3.6)
Outer Conductor	ohms/1000ft (/km)	1.27	(4.2)
Voltage Withstand	Volts DC	3000	
Jacket Spark	Volts RMS	8000	
Peak Power	kW	11.6	

Construction Specifications			
Description	Material	In.	(mm)
Inner Conductor	Solid BCCAI	0.121	(3.07)
Dielectric	Low density PTFE	0.370	(9.40)
Outer Conductor	Aluminum Tape	0.376	(9.55)
Overall Braid	Tinned Copper	0.405	(10.29)
Jacket	Orange FRPVC	0.500	(12.70)

Mechanical Specifications			
Performance Property	Units	US	(metric)
Bend Radius: installation	in. (mm)	1.25	(31.8)
Bend Radius: repeated	in. (mm)	5.0	(127.0)
Bending Moment	ft-lb (N-m)	1.75	(2.37)
Weight	lb/ft (kg/m)	0.174	(0.26)
Tensile Strength	lb (kg)	195	(88.5)
Flat Plate Crush	lb/in. (kg/mm)	200	(3.57)

Environmental Specifications		
Performance Property	°F	°C
Installation Temperature Range	+23/+167	-5/+75
Storage Temperature Range	+23/+167	-5/+75
Operating Temperature Range	+23/+167	-5/+75

Attenuation vs. Frequency (typical)

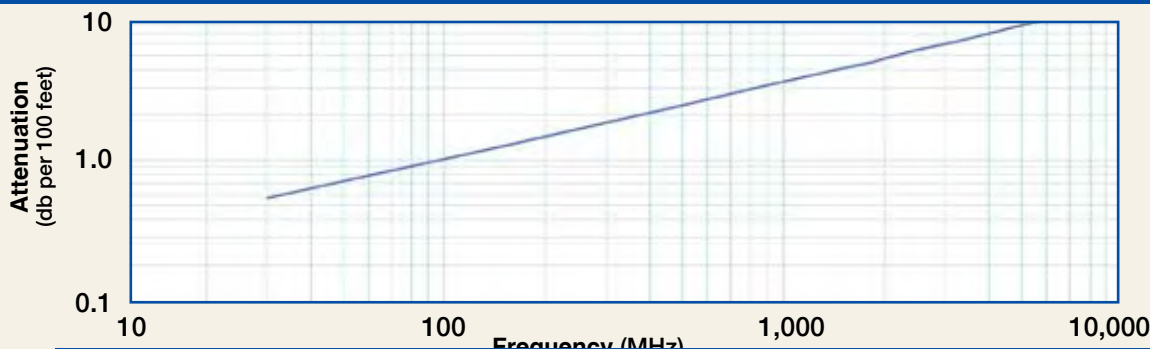

Frequency (MHz)	30	50	150	220	450	900	1500	1800	2000	2500	3400	5800
Attenuation dB/100 ft	0.6	0.7	1.3	1.5	2.2	3.1	4.1	4.5	4.8	5.4	6.4	8.5
Attenuation dB/100 m	1.8	2.4	4.1	5.0	7.2	10.3	13.5	14.8	15.7	17.7	20.9	27.9
Avg. Power kW	4.99	3.86	2.21	1.82	1.26	0.88	0.67	0.61	0.58	0.51	0.43	0.32

Calculate Attenuation = (0.100260) • √FMHz + (0.000150) • FMHz (interactive calculator available at [http://www.timesmicrowave.com/cable\\_calculators](http://www.timesmicrowave.com/cable_calculators))  
 Attenuation: VSWR=1.0 ; Ambient = +25°C (77°F) Power: VSWR=1.0; Ambient = +40°C; Jacket = +75°C (167°F);  
 Sea Level; dry air; atmospheric pressure; no solar loading



Connectors												
Interface	Description	Number	Part Code	Stock	VSWR**	Coupling Nut	Inner Contact Attach	Outer Contact Attach	Finish* Body /Pin	Length in (mm)	Width in (mm)	Weight lb (g)
1. N Male	Straight Plug	TC-500-NMH-X	3190-2514	<1.35:5	(6)	Hex/Knurl	Solder	Crimp	A/G	1.8 (45)	0.87 (22.0)	0.099 (45.0)
2. N Male	Right Angle	TC-500-NMH-RA-D	3190-2513	<1.25:1	(6)	Hex/Knurl	Solder	Crimp	A/G	1.5 (39)	1.6 (42.0)	0.279 (127.0)
3. N Male	Straight Plug	TC-500-NMC-PL	3190-900	<1.25:1	(2.5)	Hex	Solder	Clamp	S/G	2.1 (53)	0.92 (23.4)	0.228 (103.4)

\* Finish metals: N=Nickel, S=Silver, G=Gold, SS=Stainless Steel, A=Alballoy \*\*VSWR spec based on 3 foot cable with a connector pair



## Install Tools

Type	Part Number	Stock Code	Description
Crimp Tool	CT-U	3192-181	Crimp Handle (Dies Required)
Crimp Tool	CT-500	3192-169	Crimp tool for LMR-500 connectors
Crimp Dies	Y151	3190-465	.532" Hex Dies
Deburr Tool	DBT-U	3192-001	Removes center conductor rough edges
Cutting Tool	CCT-02	3192-165	Cable end flush cut tool
Strip Tool	CST-500	3192-075	Combination prep tool for LMR-500
Replacement Blade Kit	RB-CST	3192-086	Replacement blade kit for all CST strip



## LMR<sup>®</sup>-600-LLPL Flexible Low Loss Plenum Coax

### Ideal for...

- Indoor Plenum Feeder runs
- UL/NEC/CSA rated CMP/FT6
- Any wireless application (e.g. LMDS, MMDS, WLL, GPS, LMR, WLAN, WISP, WiMax, SCADA, Cellular, PCS, Paging) requiring an easily routed, low loss RF cable for in-building systems



Part Description				
Part Number	Application	Jacket	Color	Stock Code
LMR-600-LLPL	Indoor/Outdoor CMP/FT6	Plenum FRPVC	Orange	54061

Environmental Specifications			
Performance Property	°F	°C	
Installation Temperature Range	+23/+167	-5/+75	
Storage Temperature Range	+23/+167	-5/+75	
Operating Temperature Range	+23/+167	-5/+75	

Construction Specifications			
Description	Material	In.	(mm)
Inner Conductor	Solid BCCAI	0.150	(3.81)
Dielectric	Low density PTFE	0.455	(11.56)
Outer Conductor	Aluminum Tape	0.461	(11.71)
Overall Braid	Tinned Copper	0.490	(12.45)
Jacket	Orange FRPVC	0.590	(14.99)

Mechanical Specifications			
Performance Property	Units	US	(metric)
Bend Radius: installation	in. (mm)	1.5	(38.1)
Bend Radius: repeated	in (mm)	6.0	(152.4)
Bending Moment	ft-lb (N-m)	2.75	(3.73)
Weight	lb/ft (kg/m)	0.24	(0.36)
Tensile Strength	lb (kg)	265	(120.3)
Flat Plate Crush	lb/in. (kg/mm)	210	(3.75)

Electrical Specifications			
Performance Property	Units	US	(metric)
Velocity of Propagation	%	76	
Dielectric Constant	NA	1.73	
Time Delay	nS/ft (nS/m)	1.34	(4.40)
Impedance	ohms	50	
Capacitance	pF/ft (pF/m)	26.7	(87.6)
Inductance	uH/ft (uH/m)	0.067	(0.22)
Shielding Effectiveness	dB	>90	
DC Resistance			
Inner Conductor	ohms/1000ft (/km)	0.73	(2.40)
Outer Conductor	ohms/1000ft (/km)	1.20	(3.9)
Voltage Withstand	Volts DC	4000	
Jacket Spark	Volts RMS	8000	
Peak Power	kW	40	

Attenuation vs. Frequency (typical)

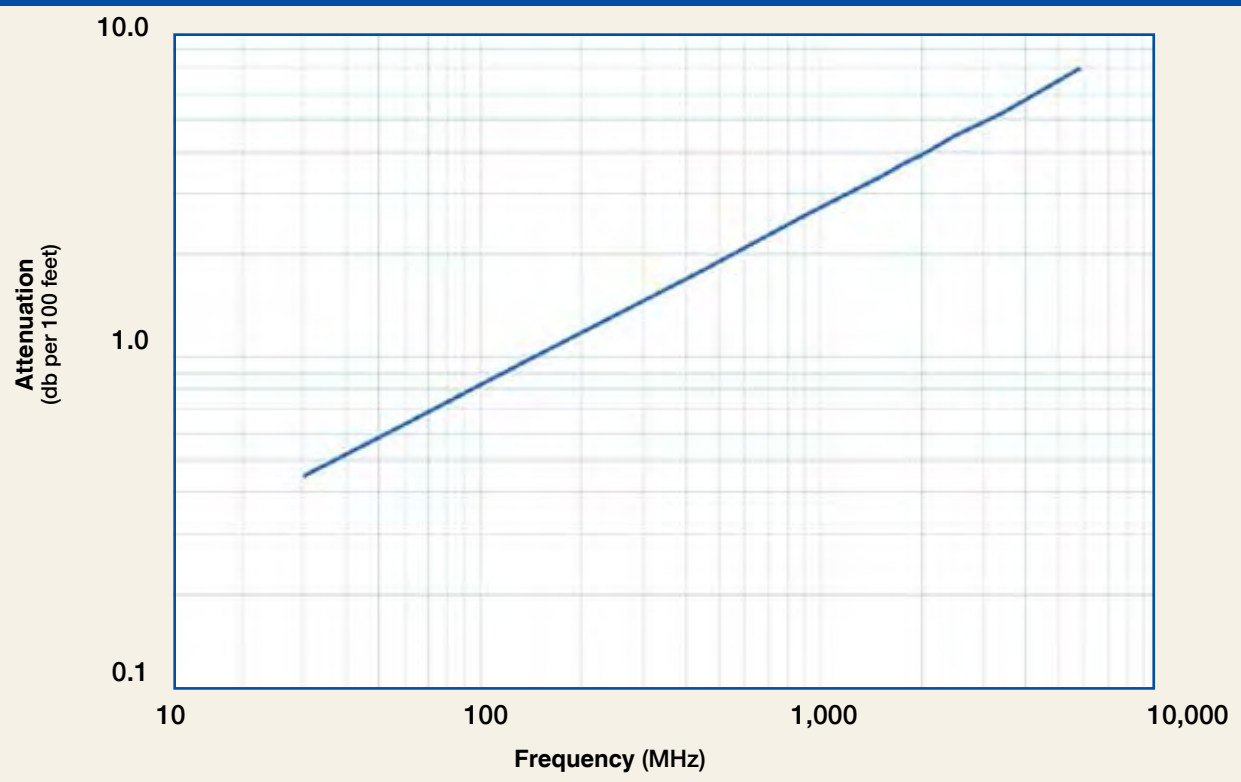

Frequency (MHz)	30	50	150	220	450	900	1500	1800	2000	2500	3400	5800	8000
Attenuation dB/100 ft	0.5	0.6	1.0	1.2	1.8	2.6	3.4	3.7	3.9	4.4	5.3	7.1	8.8
Attenuation dB/100 m	1.5	1.9	3.3	4.1	5.9	8.5	11.1	12.2	12.9	14.5	17.2	23.2	29.0
Avg. Power kW	6.97	5.39	3.08	2.53	1.75	1.22	0.93	0.84	0.79	0.70	0.59	0.44	0.26

**Calculate Attenuation =**  
 $(0.081390) \cdot \sqrt{\text{FMHz}} + (0.000150) \cdot \text{FMHz}$  (interactive calculator available at [http://www.timesmicrowave.com/cable\\_calculators](http://www.timesmicrowave.com/cable_calculators))  
**Attenuation:**  
 VSWR=1.0 ; Ambient = +25°C (77°F)  
**Power:**  
 VSWR=1.0; Ambient = +40°C; Jacket = +75°C (167°F); Sea Level; dry air; atmospheric pressure; no solar loading



# LMR®-600-LLPL Flexible Low Loss Plenum Coax



Connectors											
Interface	Part Description	Stock Number	Code	VSWR** Freq. (GHz)	Coupling Nut	Inner Contact Attach	Outer Contact Attach	Finish* Body /Pin	Length in (mm)	Width in (mm)	Weight lb (g)
1. LC Male	Straight plug	TC-600-LCM-PL	3190-1221	<1.25:1 (1)	Hex	Solder	Clamp	N/S	3.1 (78.7)	1.62 (41.1)	1.20 (544)
2. N Male	Straight Plug	EZ-600-NMH-PL-X	3190-2963	<1.25:1 (2.5)	Hex/Knurl	Spring	Finger Crimp	A/G	2.1 (53)	0.92 (23.4)	0.166 (75.3)
3. N Male	Straight Plug	TC-600-NMH-PL	3190-760	<1.25:1 (2.5)	Hex	Solder	Crimp	S/G	2.1 (53)	0.92 (23.4)	0.208 (93.4)
4. N Female	Straight Plug	TC-600-NF-PL	3190-965	<1.25:1 (6)	N/A	Solder	Crimp	S/G	2.3 (58.4)	0.87 (22.1)	0.150 (67.8)
5. BNC Male	Right Angle	TC-600-BM-RA	3190-2734	<30:1 (4)	Knurl	Solder	Crimp	A/G	1.8 (45.5)	1.54 (39.0)	0.164 (74.3)



## Hardware Accessories

Type	Part Number	Stock Code	Description
Ground Kit	GK-S600TT	GK-S600TT	Standard Grounding Kit (each)
Hoisting Grip	HG-600T	HG-600T	Split/Laced Type (each)
Cold Shrink	CS-A600T	CS-A600T	Cable to Antenna Junction (each)
Cold Shrink	CS-60120T	CS-60120T	LMR-600 to -1200 Junction (each)
Cold Shrink	CS-60170T	CS-60170T	LMR-600 to -1700 Junction (each)
Hanger Blocks	CB-600T	CB-600T	Dual Cable Support Block (kit of 10)
Hanger Block Supporting Hardware			Complete Range of Supporting Hardware & Adapters Available
Snap-In Hangers	SH-U600T	SH-U600T	Snap-In Hangers (Kit of 10)
Weather Seal Boots	WSB-600	3109-401	Weather seal/strain relief boots (10pk) for use with most popular LMR-600-X series connectors



## Install Tools

Type	Part Number	Stock Code	Description
Crimp Tool	CT-U	3192-181	Crimp Handle (Dies Required)
Crimp Tool	CT-600	3192-170	Crimp tool for LMR 600 connector
Crimp Dies	Y1720	3190-203	.610" Hex Dies
Crimp Rings	CR-600	3190-831	Crimp Rings for TC/EZ-600 connectors (pkg of 10)
Midspan Strip Tool	GST-600A	3190-1051	For ground strap attachment
Cutting Tool	CCT-02	3192-165	Cable end flush cut tool
Replacement Blade	RB-02	3192-166	Replacement blade for cutting tool
Replacemnt Blade Kit	RB-CST	3192-086	Replacement blade kit for all CST strip tools
Replacement Blades	RB-456	3190-421	Replacement blades for CST-600C and ST-600EZ
Prep Tool	CST-600	3192-052	Prep tool for LMR-600 crimp/clamp style connectors
Tool Kit	TK-600EZ	3190-1602	Tool kit for LMR-600 crimp/clamp connectors (includes CCT-02, CST-600, CT-600, Tool Pouch)

# LMR<sup>®</sup>-900-LLPL Flexible Low Loss Plenum Coax

## Ideal for...

- Indoor Plenum Feeder runs
- UL/NEC/CSA rated CMP/FT6
- Any wireless application (e.g. LMDS, MMDS, WLL, GPS, LMR, WLAN, WISP, WiMax, SCADA, Cellular, PCS, Paging) requiring an easily routed, low loss RF cable for in-building systems



Part Description				
Part Number	Application	Jacket	Color	Stock Code
LMR-900-LLPL	Indoor/Outdoor Plenum CMP/FT6	FRPVC	Orange	54062

Environmental Specifications			
Performance Property	°F	°C	
Installation Temperature Range	+23/+167	-5/+75	
Storage Temperature Range	+23/+167	-5/+75	
Operating Temperature Range	+23/+167	-5/+75	

Construction Specifications			
Description	Material	In.	(mm)
Inner Conductor	BC Tube	0.227	(5.77)
Dielectric	Low density PTFE	0.680	(17.27)
Outer Conductor	Aluminum Tape	0.686	(17.42)
Overall Braid	Tinned Copper	0.732	(18.59)
Jacket	Orange FRPVC	0.870	(22.10)

Mechanical Specifications			
Performance Property	Units	US	(metric)
Bend Radius: installation	in. (mm)	3.00	(76.2)
Bend Radius: repeated	in. (mm)	9.0	(228.6)
Bending Moment	ft-lbs (N-m)	9.0	(12.20)
Weight	lbs/ft (kg/m)	0.542	(0.81)
Tensile Strength	lbs (kg)	660	(299.6)
Flat Plate Crush	lbs/in. (kg/mm)	300	(5.36)

Electrical Specifications			
Performance Property	Units	US	(metric)
Velocity of Propagation	%	76	
Dielectric Constant	NA	1.73	
Time Delay	nS/ft (nS/m)	1.34	(4.40)
Impedance	ohms	50	
Capacitance	pF/ft (pF/m)	26.7	(87.6)
Inductance	uH/ft (uH/m)	0.067	(0.22)
Shielding Effectiveness	dB	>90	
DC Resistance			
Inner Conductor	ohms/1000ft (/km)	0.63	(2.07)
Outer Conductor	ohms/1000ft (/km)	0.55	(1.8)
Voltage Withstand	Volts DC	5000	
Jacket Spark	Volts RMS	8000	
Peak Power	kW	62	

TIMES MICROWAVE

Attenuation vs. Frequency (typical)

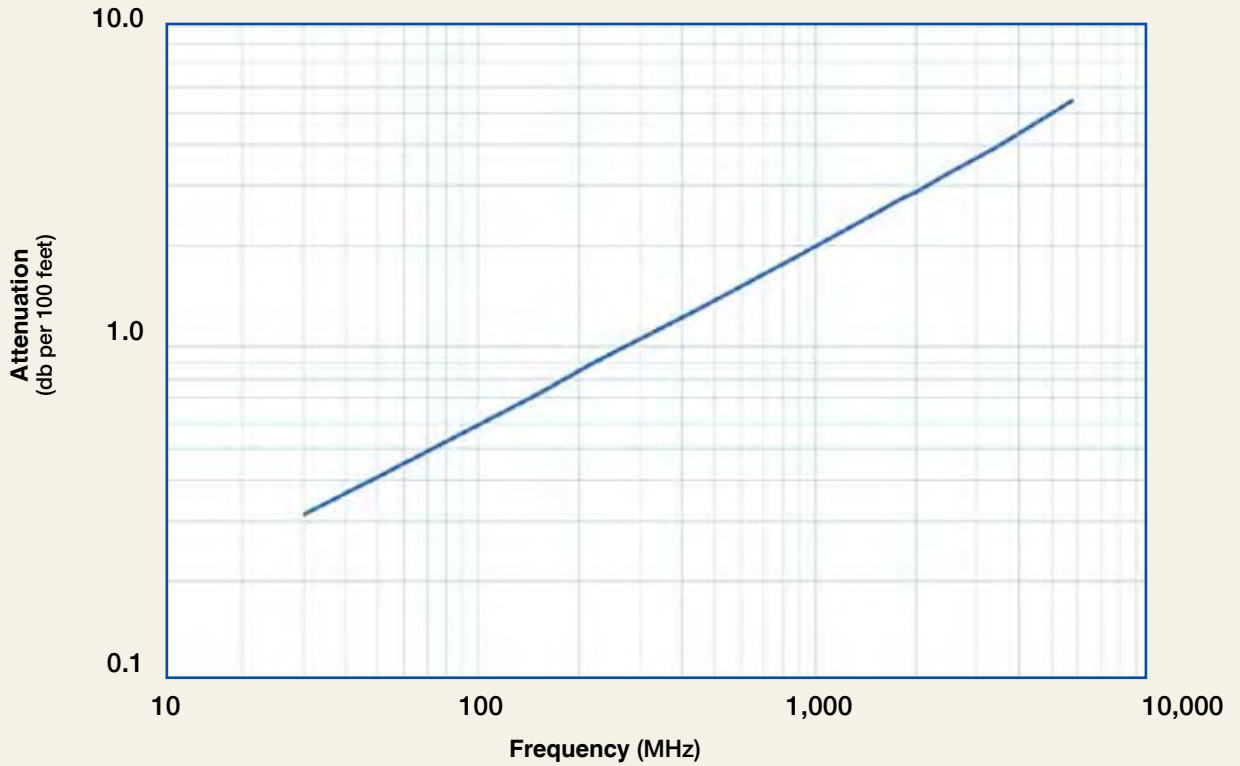

Frequency (MHz)	30	50	150	220	450	900	1500	1800	2000	2500	3400	5800
Attenuation dB/100 ft	0.3	0.4	0.7	0.9	1.3	1.9	2.5	2.8	2.9	3.3	4.0	5.4
Attenuation dB/100 m	1.0	1.4	2.4	2.9	4.3	6.2	8.2	9.0	9.6	10.9	13.0	17.8
Avg. Power kW	13.21	10.18	5.77	4.74	3.25	2.24	1.69	1.52	1.44	1.26	1.06	0.77

**Calculate Attenuation =**  
 $(0.057220) \cdot \sqrt{\text{FMHz}} + (0.000183) \cdot \text{FMHz}$  (interactive calculator available at [http://www.timesmicrowave.com/cable\\_calculators](http://www.timesmicrowave.com/cable_calculators))

**Attenuation:**  
 VSWR=1.0 ; Ambient = +25°C (77°F)

**Power:**  
 VSWR=1.0; Ambient = +40°C; Jacket = +75°C (167°F); Sea Level; dry air; atmospheric pressure; no solar loading

## LMR®-900-LLPL Flexible Low Loss Plenum Coax



Connectors												
Interface	Description	Part Number	Stock Code	VSWR** Freq.	(GHz)	Coupling Nut	Inner Contact Attach	Outer Contact Attach	Finish* Body /Pin	Length in (mm)	Width in (mm)	Weight lb (g)
1. 7-16 Male	Straight Plug	EZ-900-716-MC-PL-2	3190-1549	<1.25:1	(2.5)	Hex	Press Fit	Clamp	S/S	2.0	(51)	1.44 (36.6) 0.485 (220.0)
2. N Female	Straight Jack	EZ-900-NFC-PL-2	3190-1586	<1.25:1	(2.5)	NA	Press Fit	Clamp	S/G	2.0	(51)	1.38 (35.1) 0.443 (200.9)
3. N Male	Straight Plug	EZ-900-NMC-PL-2	3190-1585	<1.25:1	(2.5)	Hex/Knurl	Press Fit	Clamp	S/S	2.0	(51)	1.38 (35.1) 0.463 (210.0)

\* Finish metals: N=Nickel, S=Silver, G=Gold, SS=Stainless Steel, A=Albally \*VSWR spec based on 3 foot cable with a connector pair



### Install Tools

Type	Part Number	Stock Code	Description
Strip Tool	ST-900C	3190-1310	For LMR 900 Clamp Style Connectors
Midspan Strip Tool	GST-900A	3190-435	For Ground Strap Attachment
Wrenches	WR-900	3190-510	1-1/4" Box Wrench (2 required)
Cutting Tool	CCT-02	3192-165	Cable end flush cut tool
Replacement Blade	RB-02	3192-166	Replacement blade for cutting tool



## Hardware Accessories

Type	Part Number	Stock Code	Description
Ground Kit	GK-S900TT	GK-S900TT	Standard Grounding Kit (each)
Hoisting Grip	HG-900T	HG-900T	Split/Laced Type (each)
Cold Shrink	CS-A900T	CS-A900T	Cable to Antenna Junction (each)
Cold Shrink	CS-90120T	CS-90120T	LMR-900 to -1200 Junction (each)
Cold Shrink	CS-90170T	CS-90170T	LMR-900 to -1700 Junction (each)
Port Cushion	SC-900T-3	SC-900T-3	Three Cables (each)
Standard Entry Panels			Full Range of Port Styles/Combinations Available
Hanger Blocks	CB-900T	CB-900T	Dual Cable Support Block (kit of 10)
Hanger Block Supporting Hardware			Complete Range of Supporting Hardware and Adapters Available
Snap-in Hangers	SH-U900T	SH-U900T	Snap-in Hanger (Kit of 10)

# LMR<sup>®</sup>-1200-LLPL Flexible Low Loss Plenum Coax

## Ideal for...

- Indoor Plenum Feeder runs
- UL/NEC/CSA rated CMP/FT6
- Any wireless application (e.g. LMDS, MMDS, WLL, GPS, LMR, WLAN, WISP, WiMax, SCADA, Cellular, PCS, Paging) requiring an easily routed, low loss RF cable for in-building systems



Part Description				
Part Number	Application	Jacket	Color	Stock Code
LMR-1200-LLPL	Indoor/Outdoor Plenum CMP/FT6	FRPVC	Orange	54063

Environmental Specifications		
Performance Property	°F	°C
Installation Temperature Range	+23/+167	-5/+75
Storage Temperature Range	+23/+167	-5/+75
Operating Temperature Range	+23/+167	-5/+75

Construction Specifications			
Description	Material	In.	(mm)
Inner Conductor	BC Tube	0.310	(7.87)
Dielectric	Low density PTFE	0.920	(23.37)
Outer Conductor	Aluminum Tape	0.926	(23.52)
Overall Braid	Tinned Copper	0.972	(24.69)
Jacket	Orange FRPVC	1.200	(30.48)

Mechanical Specifications			
Performance Property	Units	US	(metric)
Bend Radius: installation	in. (mm)	6.0	(152.4)
Bend Radius: repeated	in.s (mm)	12.0	(304.8)
Bending Moment	ft-lbs (N-m)	15.0	(20.34)
Weight	lbs/ft (kg/m)	0.7	(1.04)
Tensile Strength	lbs (kg)	975	(442.7)
Flat Plate Crush	lbs/in. (kg/mm)	375	(6.70)

Electrical Specifications			
Performance Property	Units	US	(metric)
Velocity of Propagation	%	76	
Dielectric Constant	NA	1.73	
Time Delay	nS/ft (nS/m)	1.34	(4.40)
Impedance	ohms	50	
Capacitance	pF/ft (pF/m)	26.7	(87.6)
Inductance	uH/ft (uH/m)	0.067	(0.22)
Shielding Effectiveness	dB	>90	
DC Resistance			
Inner Conductor	ohms/1000ft (/km)	0.37	(1.21)
Outer Conductor	ohms/1000ft (/km)	0.37	(1.2)
Voltage Withstand	Volts DC	6000	
Jacket Spark	Volts RMS	8000	
Peak Power	kW	90	

Attenuation vs. Frequency (typical)

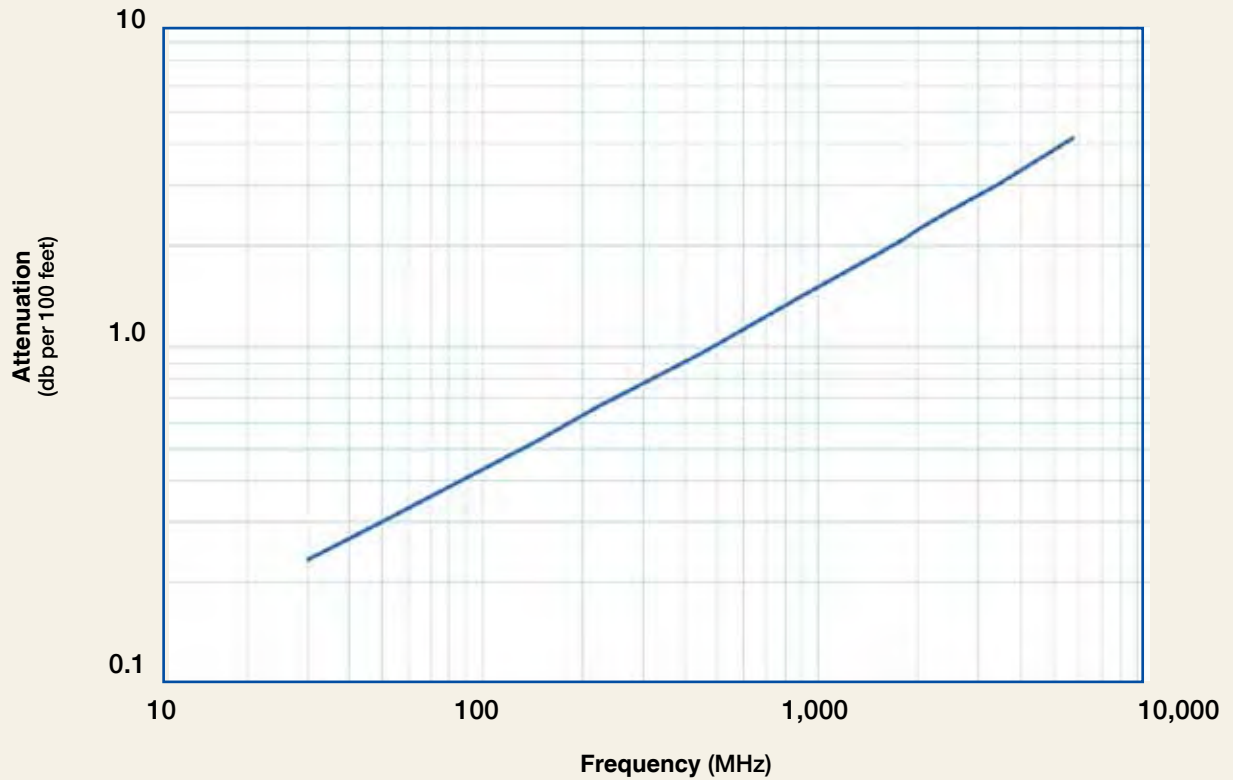

Frequency (MHz)	30	50	150	220	450	900	1500	1800	2000	2500	3400
Attenuation dB/100 ft	0.2	0.3	0.5	0.7	1.0	1.4	1.9	2.1	2.2	2.5	3.1
Attenuation dB/100 m	0.8	1.0	1.8	2.2	3.2	4.6	6.2	6.9	7.3	8.3	10.0
Avg. Power kW	23.42	18.01	10.17	8.31	5.66	3.86	2.90	2.60	2.45	2.15	1.79

**Calculate Attenuation =**

$(0.041720) \cdot \sqrt{\text{FMHz}} + (0.000183) \cdot \text{FMHz}$  (interactive calculator available at [http://www.timesmicrowave.com/cable\\_calculators](http://www.timesmicrowave.com/cable_calculators))

**Attenuation:**

VSWR=1.0 ; Ambient = +25°C (77°F)

**Power:**

VSWR=1.0; Ambient = +40°C; Jacketr = +75°C (167°F); Sea Level; dry air; atmospheric pressure; no solar loading



# LMR<sup>®</sup>-1200-LLPL Flexible Low Loss Plenum Coax



Connectors											
Interface	Description	Part Number	Stock Code	VSWR** Freq. (GHz)	Coupling Nut	Inner Contact Attach	Outer Contact Attach	Finish* Body /Pin	Length in (mm)	Width in (mm)	Weight lb (g)
1. N Female	Straight Jack	EZ-1200-NFC-PL	3190-912	<1.25:1 (2.5)	NA	Press Fit	Clamp	S/S	2.0 (51)	1.65(41.9)	0.650(294.8)
2. N Male	Straight Plug	EZ-1200-NMC-PL-2	3190-6021	<1.25:1 (2.5)	Hex	Press Fit	Clamp	S/S	2.0 (51)	1.65(41.9)	0.659(298.9)

\* Finishes: N=Nickel, S=Silver, G=Gold, SS=Stainless Steel, A=Alballoy \*\*VSWR spec based on 3 foot cable with a connector pair



## Install Tools

Type	Part Number	Stock Code	Description
Midspan Strip Tool	GST-1200A	3190-436	For Ground Strap Attachment
Wrench	WR-1200A	3190-512	1-9/16" Box Wrench (1 required)
Wrench	WR-1200B	3190-511	1-7/16" Box Wrench (1 required)
Cutting Tool	CCT-02	3192-165	Cable end flush cut tool
Strip Tool	ST-1200-CH	3192-124	For LMR-1200 clamp style connectors
Replacement Blade	RB-02	3192-166	Replacement blade for cutting tool



## Hardware Accessories

Type	Part Number	Stock Code	Description
Ground Kit	GK-S1200TT	GK-S1200TT	Standard Grounding Kit (each)
Hoisting Grip	HG-1200T	HG-1200T	Split/Laced Type (each)
Cold Shrink	CS-90120T	CS-90120T	LMR-900 to -1200 Junction (each)
Cold Shrink	CS-60120T	CS-60120T	LMR-600 to -1200 Junction (each)
Standard Entry Port Cushion	SC-1200T-3	SC-1200T-3	Three Cables (each)
Standard Entry Panels	Full Range of Port Styles/Combinations Available		
Hanger Blocks	CB-1200T	CB-1200T	Dual Cable Support Block (kit of 10)
Hanger Block Supporting Hardware	Complete Range of Supporting Hardware & Adapters Available		
Snap-In Hangers	SH-U1200T	SH-U1200T	Snap-In Hangers (Kit of 10)

# LMR<sup>®</sup>-200-75 Ohm Flexible Low Loss Coaxial Cable

## Ideal for...

- Satellite Applications
- Video Applications-CCTV, CATV, baseband or broadband
- In-Building Feeder Runs
- Any 75 ohm Wireless Application requiring an easily routed,

• **LMR<sup>®</sup>-75** standard is a UV Resistant Polyethylene jacketed cable designed for 20-year service outdoor use. The bending and handling characteristics are significantly better than any smooth wall or corrugated hard-line cables.

• **Flexibility** and bendability are hallmarks of the LMR-200-75 cable design. The flexible outer conductor enables the tightest bend radius available for any cable of similar size and performance.

• **Low Loss** is another hallmark feature of LMR-75. Size for size LMR-75 has the lowest loss of any flexible cable and comparable loss to semirigid hard-line cables.

• **RF Shielding** is 50 dB greater than typical single shielded coax (40 dB). The multi-ply bonded foil outer conductor is rated conservatively at > 90 dB (i.e. >180 dB between two adjacent cables).

• **Weatherability:** LMR-75 cables designed for outdoor exposure incorporate the best materials for UV resistance and have life expectancy in excess of 20 years.

• **Connectors:** Standard available connectors include type-N and type-F male plug with 75 ohm interface. Most LMR-75 connectors are the EZ install type with crimp outer and non-solder center contact attachment.

• **Cable Assemblies:** All LMR-75 cable types are available as pre-terminated cable assemblies. Refer to the section on FlexTech for further details.

Part Description				
Part Number	Application	Jacket Color	Color	Stock Code
LMR-200-75	Indoor/Outdoor	PE	Black	54213
LMR-200-75-DB	Outdoor	PE	Black	54242



Construction Specifications			
Description	Material	In.	(mm)
Inner Conductor	Solid BC	0.025	(0.64)
Dielectric	Foam PE	0.116	(2.95)
Outer Conductor	Aluminum Tape	0.121	(3.07)
Overall Braid	Tinned Copper	0.144	(3.66)
Jacket	Black PE	0.195	(4.95)

Mechanical Specifications			
Performance Property	Units	US	(metric)
Bend Radius: installation	in. (mm)	0.5	(12.7)
Bend Radius: repeated	in. (mm)	2	(50.8)
Bending Moment	ft-lb (N-m)	0.2	(0.27)
Weight	lb/ft (kg/m)	0.022	(0.03)
Tensile Strength	lb (kg)	40	(18.2)
Flat Plate Crush	lb/in. (kg/mm)	15	(0.27)

Environmental Specifications		
Performance Property	°F	°C
Installation Temperature Range	-40/+185	-40/+85
Storage Temperature Range	-94/+185	-70/+85
Operating Temperature Range	-40/+185	-40/+85

Electrical Specifications			
Performance Property	Units	US	(metric)
Max Operating Frequency	GHz	2.5	
Velocity of Propagation	%	83	
Dielectric Constant	NA	1.45	
Time Delay	nS/ft (nS/m)	1.22	(4.02)
Impedance	ohms	75	
Capacitance	pF/ft (pF/m)	16.3	(53.6)
Inductance	uH/ft (uH/m)	0.092	(0.30)
Shielding Effectiveness	dB	>90	
DC Resistance			
Inner Conductor	ohms/1000ft (/km)	16.8	(55.1)
Outer Conductor	ohms/1000ft (/km)	4.9	(16.1)
Voltage Withstand	Volts DC	1000	
Jacket Spark	Volts RMS	3000	
Peak Power	kW	2.5	

**Attenuation vs. Frequency (typical)**

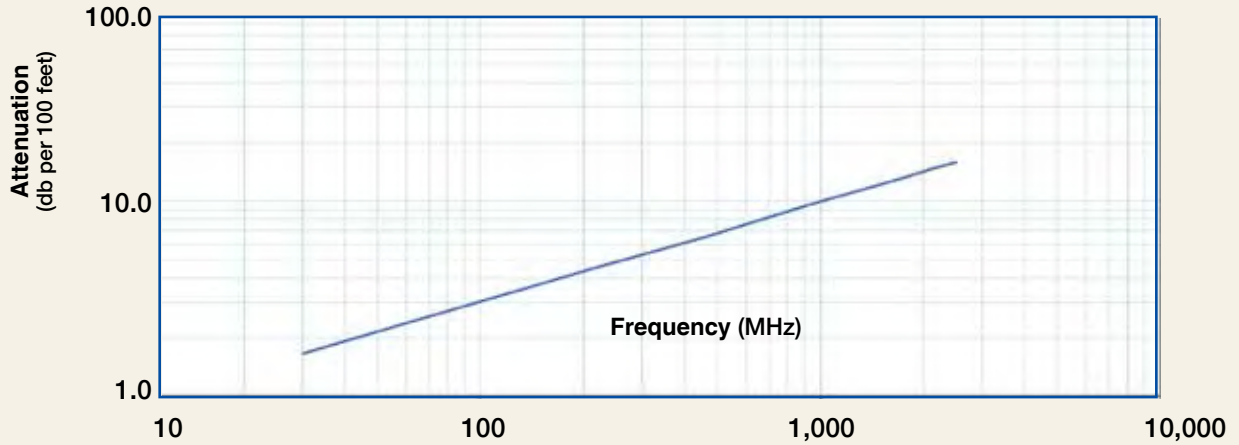

Frequency (MHz)	30	50	150	220	450	900	1500	1800	2000	2500
Attenuation dB/100 ft	1.7	2.1	3.7	4.5	6.5	9.3	12.1	13.4	14.1	15.9
Attenuation dB/100 m	5.4	7.0	12.2	14.9	21.4	30.6	39.8	43.8	46.3	52.0
Avg. Power kW	0.98	0.76	0.43	0.36	0.25	0.17	0.13	0.12	0.11	0.10

Calculate Attenuation =  $(0.300717) \cdot \sqrt{\text{FMHz}} + (0.000335) \cdot \text{FMHz}$  (interactive calculator available at [http://www.timesmicrowave.com/cable\\_calculators](http://www.timesmicrowave.com/cable_calculators))

Attenuation: VSWR=1.0; Ambient = +25°C (77°F)

Power: VSWR=1.0; Ambient = +40°C; Inner Conductor = 100°C (212°F); Sea Level; dry air; atmospheric pressure; no solar loading

**Connectors**

Interface	Description	Part Number	Stock Code	VSWR** Freq. (GHz)	Coupling Nut	Inner Contact Attach	Outer Contact Attach	Finish* Body /Pin	Length in (mm)	Width in (mm)	Weight lb (g)
1. F Male	Straight Plug	EZ-200-FMH-75	3190-1611	<1.35:1 (2.5)	Hex	Spring Finger Crimp		N/G	1.1 (27.0)	0.50 (12.7)	0.015 (6.8)
2. N Male	Straight Plug	EZ-200-NM-75	3190-1612	<1.35:1 (2.5)	Knurl	Spring Finger Crimp		N/G	1.5 (38.1)	0.83 (21.1)	0.073 (33.1)

\* Finish metals: N=Nickel, S=Silver, G=Gold, SS=Stainless Steel, A=Alballoy \*\*VSWR spec based on 3 foot cable with a connector pair



**Install Tools**

Type	Part Number	Stock Code	Description
Crimp Tool	CT-240/200/195	3190-667	Crimp tool for LMR 240, 200 and 195
Strip Tool	CST-195/200	3192-102	Combination prep tool for LMR-195/200 crimp and clamp connectors
Cutting Tool	CCT-02	3192-165	Cable end flush cut tool
Replacement Blade Kit	RB-CST	3192-086	Replacement blade kit for all CST tools
Debur Tool	DBT-U	3192-001	Removes center conductor rough edges

**Accessories**

Type	Part Number	Stock Code	Description
Ground Kit	GK-S200TT	GK-S200TT	Standard Grounding Kit



# LMR<sup>®</sup>-240-75 Ohm Flexible Low Loss Coaxial Cable



## Ideal for...

- Satellite Applications
- Video Applications-CCTV, CATV, baseband or broadband
- In-Building Feeder Runs
- Any 75 Ohm Wireless Application requiring an easily routed, low loss RF cable

Part Description				
Part Number	Application	Jacket	Color	Stock Code
LMR-240-75	Indoor/Outdoor	PE	Black	54150
LMR-240-75-DB	Outdoor	PE	Black	54226
LMR-240-75-FR	Indoor	FRPE	Black	54259

Environmental Specifications			
Performance Property	°F	°C	
Installation Temperature Range	-40/+185	-40/+85	
Storage Temperature Range	-94/+185	-70/+85	
Operating Temperature Range	-40/+185	-40/+85	

Mechanical Specifications			
Performance Property	Units	US	(metric)
Bend Radius: installation	in. (mm)	0.75	(19.1)
Bend Radius: repeated	in. (mm)	2.5	(63.5)
Bending Moment	ft-lb (N-m)	0.25	(0.34)
Weight	lb/ft (kg/m)	0.034	(0.05)
Tensile Strength	lb (kg)	80	(38.3)
Flat Plate Crush	lb/in. (kg/mm)	20	(0.36)

Construction Specifications			
Description	Material	In.	(mm)
Inner Conductor	Solid BC	0.032	(0.82)
Dielectric	Foam PE	0.150	(3.81)
Outer Conductor	Aluminum Tape	0.155	(3.94)
Overall Braid	Tinned Copper	0.178	(4.52)
Jacket	(See Table)	0.240	(6.10)

Electrical Specifications			
Performance Property	Units	US	(metric)
Max Operating Frequency	GHz	2.5	
Velocity of Propagation	%	84	
Dielectric Constant	NA	1.42	
Time Delay	nS/ft (nS/m)	1.21	(3.97)
Impedance	ohms	75	
Capacitance	pF/ft (pF/m)	16.1	(52.9)
Inductance	uH/ft (uH/m)	0.091	(0.30)
Shielding Effectiveness	dB	>90	
DC Resistance			
Inner Conductor	ohms/1000ft (/km)	10.1	(33.1)
Outer Conductor	ohms/1000ft (/km)	3.89	(12.8)
Voltage Withstand	Volts DC	1500	
Jacket Spark	Volts RMS	5000	
Peak Power	kW	5.6	

## Attenuation vs. Frequency (typical)

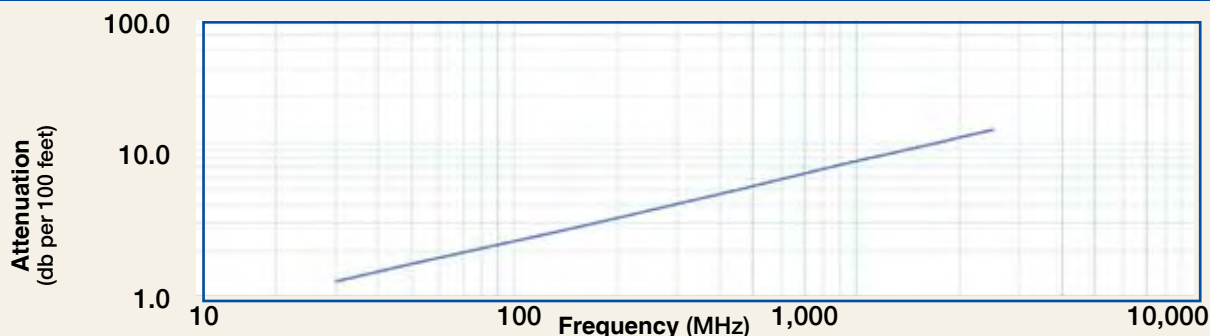

Frequency (MHz)	30	50	150	220	450	900	1500	1800	2000	2500
Attenuation dB/100 ft	1.3	1.6	2.9	3.5	5.0	7.2	9.4	10.3	10.9	12.3
Attenuation dB/100 m	4.1	5.4	9.4	11.4	16.4	23.5	30.7	33.8	35.8	40.3
Avg. Power kW	1.41	1.09	0.62	0.51	0.35	0.25	0.19	0.17	0.16	0.14

**Calculate Attenuation** =  $(0.229100) \cdot \sqrt{\text{FMHz}} + (0.000330) \cdot \text{FMHz}$  (interactive calculator available at [http://www.timesmicrowave.com/cable\\_calculators](http://www.timesmicrowave.com/cable_calculators)) **Attenuation:** VSWR=1.0 ; Ambient = +25°C (77°F) **Power:** VSWR=1.0; Ambient = +40°C; Inner Conductor = 100°C (212°F); Sea Level; dry air; atmospheric pressure; no solar loading

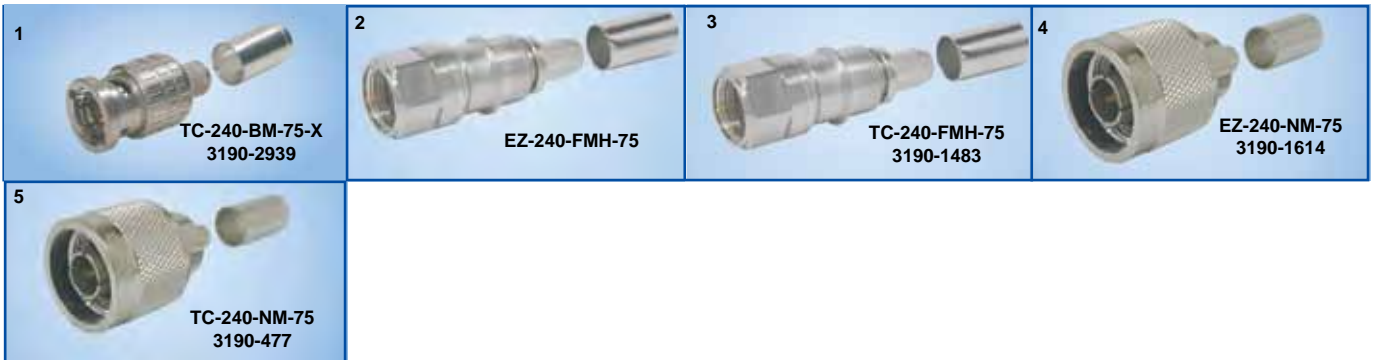

<b>Connectors</b>												
Interface	Description	Part Number	Stock Code	VSWR** Freq. (GHz)	Coupling Nut	Inner Contact Attach	Outer Contact Attach	Finish* Body /Pin	Length in (mm)	Width in (mm)	Weight lb	Weight (g)
1. BNC Male	Straight Plug	TC-240-BM-75-X	3190-2939	<1.1:1 (2.0)	Knurl	Solder-on	Crimp	A/G	1.37 (34.8)	0.56 (14.2)	0.043 (19.5)	
2. F Male	Straight Plug	EZ-240-FMH-75	3190-1613	<1.25:1 (2.0)	Hex	Spring Finger	Crimp	N/G	1.7 (43.4)	0.56 (14.2)	0.016 (7.3)	
3. F Male	Straight Plug	TC-240-FMH-75	3190-1483	<1.25:1 (2.5)	Hex	Solder-on	Crimp	N/G	1.7 (43.2)	0.56 (14.2)	0.016 (7.3)	
4. N Male	Straight Plug	EZ-240-NM-75	3190-1614	<1.25:1 (2.0)	Knurl	Spring Finger	Crimp	N/G	1.5 (38.1)	0.83 (21.1)	0.086 (39.0)	
5. N Male	Straight Plug	TC-240-NM-75	3190-477	<1.25:1 (2.5)	Knurl	Solder-on	Crimp	N/G	1.5 (38.1)	0.83 (21.1)	0.086 (39.0)	

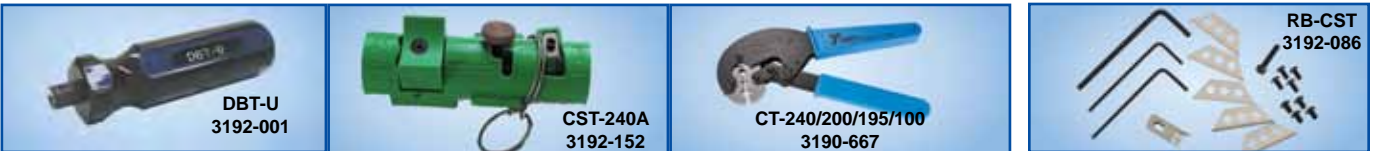

## Accessories & Install Tools

Type	Part Number	Stock Code	Description
Ground Kit	GK-S240TT	GK-S240TT	Standard Grounding Kit
Strip Tool	CST-240A	3192-152	Prep tool for LMR-240 connectors
Replacement Blade Kit	RB-CST	3192-086	Replacement blade kit for all CST strip tool
Deburr Tool	DBT-U	3192-001	Removes center conductor rough edges
Crimp Tool	CT-240/200/195/100	3190-667	Crimp tool for LMR-100, 195, 200 and 240 connectors



## LMR<sup>®</sup>-300-75 Ohm Flexible Low Loss Coaxial Cable

### Ideal for...

- Satellite Applications
- Video Applications-CCTV, CATV, baseband or broadband
- In-Building Feeder Runs
- Any 75 ohm Wireless Application requiring an easily routed,



### Part Description

Part Number	Application	Jacket	Color	Stock Code
LMR-300-75	Indoor/Outdoor	PE	Black	54146
LMR-300-75-DB	Outdoor	PE	Black	54241

### Environmental Specifications

Performance Property	°F	°C
Installation Temperature Range	-40/+185	-40/+85
Storage Temperature Range	-94/+185	-70/+85
Operating Temperature Range	-40/+185	-40/+85

### Construction Specifications

Description	Material	In.	(mm)
Inner Conductor	Solid BC	0.044	(1.12)
Dielectric	Foam PE	0.190	(4.83)
Outer Conductor	Aluminum Tape	0.196	(4.98)
Overall Braid	Tinned Copper	0.225	(5.72)
Jacket	Black PE	0.300	(7.62)

### Mechanical Specifications

Performance Property	Units	US	(metric)
Bend Radius: installation	in. (mm)	0.875	(22.2)
Bend Radius: repeated	in. (mm)	3.0	(76.2)
Bending Moment	ft-lb (N-m)	0.38	(0.52)
Weight	lb/ft (kg/m)	0.055	(0.08)
Tensile Strength	lb (kg)	120	(54.5)
Flat Plate Crush	lb/in. (kg/mm)	30	(0.54)

### Electrical Specifications

Performance Property	Units	US	(metric)
Max Operating Frequency	GHz	2.5	
Velocity of Propagation	%	85	
Dielectric Constant	NA	1.38	
Time Delay	nS/ft (nS/m)	1.20	(3.92)
Impedance	ohms	75	
Capacitance	pF/ft (pF/m)	15.9	(52.3)
Inductance	uH/ft (uH/m)	0.090	(0.29)
Shielding Effectiveness	dB	>90	
DC Resistance			
Inner Conductor	ohms/1000ft (/km)	5.36	(17.6)
Outer Conductor	ohms/1000ft (/km)	2.21	(7.3)
Voltage Withstand	Volts DC	2000	
Jacket Spark	Volts RMS	5000	
Peak Power	kW	10	

**Attenuation vs. Frequency (typical)**

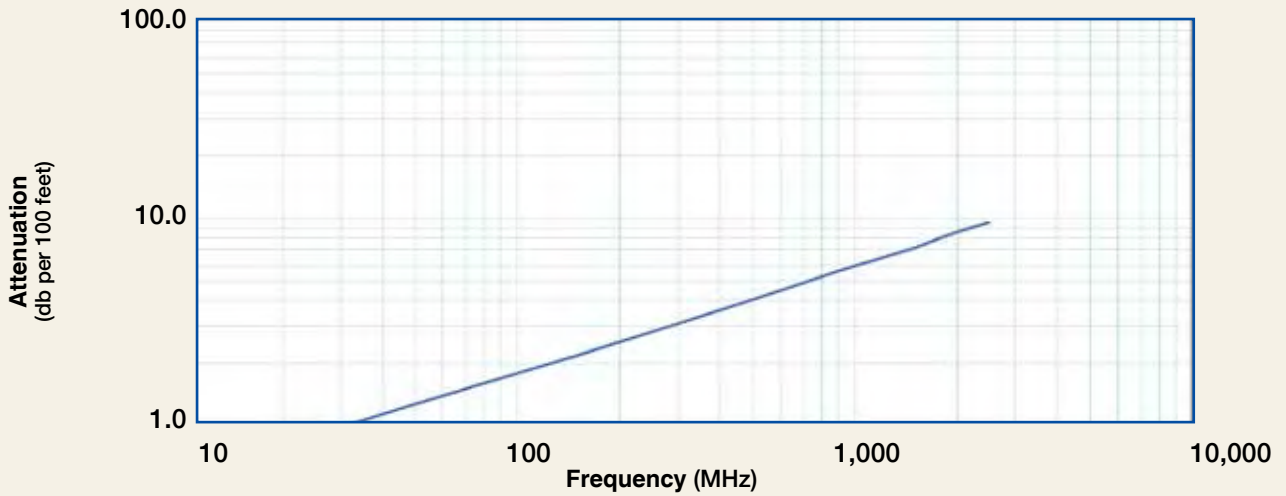

Frequency (MHz)	30	50	150	220	450	900	1500	1800	2000	2500
Attenuation dB/100 ft	1.0	1.3	2.2	2.7	3.9	5.6	7.3	8.0	8.5	9.6
Attenuation dB/100 m	3.2	4.1	7.2	8.8	12.7	18.2	23.9	26.4	27.9	31.5
Avg. Power kW	2.06	1.59	0.91	0.74	0.51	0.36	0.27	0.25	0.23	0.21

Calculate Attenuation =  $(0.175490) \cdot \sqrt{\text{FMHz}} + (0.000330) \cdot \text{FMHz}$  (interactive calculator available at [http://www.timesmicrowave.com/cable\\_calculators](http://www.timesmicrowave.com/cable_calculators))  
 Attenuation: VSWR=1.0 ; Ambient = +25°C (77°F) Power: VSWR=1.0; Ambient = +40°C; Inner Conductor = 100°C (212°F);  
 Sea Level; dry air; atmospheric pressure; no solar loading



**Connectors**

Interface	Description	Part Number	Stock Code	VSWR** Freq. (GHz)	Coupling Nut	Inner Contact Attach	Outer Contact Attach	Finish* /Pin	Length in (mm)	Width in (mm)	Weight lb (g)
1. BNC Male	Straight Plug	TC-300-BM-75-X	3190-2959	<1.1:1 (2.0)	Knurl	Solder-on	Crimp	N/G	1.37 (34.8)	0.56(14.2)	0.043 (19.5)
2. F Male	Straight Plug	EZ-300-FMH-75	3190-1615	<1.25:1 (2.5)	Hex	Spring Finger	Crimp	N/G	1.7 (43.2)	0.56(14.2)	0.018 (8.2)
3. N Male	Straight Plug	EZ-300-NM-75	3190-1616	<1.25:1 (2.5)	Knurl	Spring Finger	Crimp	N/G	1.5 (38.1)	0.83(21.1)	0.074 (33.6)

\* Finish metals: N=Nickel, S=Silver, G=Gold, SS=Stainless Steel, A=Alballoy \*\*VSWR spec based on 3 foot cable with a connector pair



**Install Tools**

Type	Part Number	Stock Code	Description
Crimp Tool	CT-300/400	3190-666	Crimp tool for LMR 300 and 400
Strip Tool	CST-300	3192-084	Combination prep tool for LMR-300 crimp and clamp connectors
Cutting Tool	CCT-02	3192-165	Cable end flush cut tool
Replacement Blade Kit	RB-CST	3192-086	Replacement blade kit for all CST tools
Debur Tool	DBT-U	3192-001	Removes center conductor rough edges

**Accessories**

Type	Part Number	Stock Code	Description
Ground Kit	GK-S300TT	GK-S300TT	Standard Grounding Kit





# LMR<sup>®</sup>-400-75 Ohm Flexible Low Loss Coaxial Cable

## Ideal for...

- Satellite Applications
- Video Applications-CCTV, CATV, baseband or broadband
- In-Building Feeder Runs
- Any 75 ohm Wireless Application requiring an easily routed,



Part Description				
Part Number	Application	Jacket	Color	Stock Code
LMR-400-75	Indoor/Outdoor	PE	Black	54147
LMR-400-75-DB	Outdoor	PE	Black	54228
LMR-400-75-FR	Indoor	FRPE	Black	54256

Construction Specifications			
Description	Material	In.	(mm)
Inner Conductor	Solid BC	0.065	(1.65)
Dielectric	Foam PE	0.285	(7.24)
Outer Conductor	Aluminum Tape	0.291	(7.39)
Overall Braid	Tinned Copper	0.320	(8.13)
Jacket	(See Table)	0.405	(10.29)

Environmental Specifications		
Performance Property	°F	°C
Installation Temperature Range	-40/+185	-40/+85
Storage Temperature Range	-94/+185	-70/+85
Operating Temperature Range	-40/+185	-40/+85

Mechanical Specifications			
Performance Property	Units	US	(metric)
Bend Radius: installation	in. (mm)	1.0	(25.4)
Bend Radius: repeated	in. (mm)	4.0	(101.6)
Bending Moment	ft-lb (N-m)	0.5	(0.68)
Weight	lb/ft (kg/m)	0.068	(0.10)
Tensile Strength	lb (kg)	160	(72.6)
Flat Plate Crush	lb/in. (kg/mm)	40	(0.71)

Electrical Specifications			
Performance Property	Units	US	(metric)
Max Operating Frequency	GHz	2.5	
Velocity of Propagation	%	85	
Dielectric Constant	NA	1.38	
Time Delay	nS/ft (nS/m)	1.20	(3.92)
Impedance	ohms	75	
Capacitance	pF/ft (pF/m)	15.9	(52.3)
Inductance	uH/ft (uH/m)	0.090	(0.29)
Shielding Effectiveness	dB	>90	
DC Resistance			
Inner Conductor	ohms/1000ft (/km)	2.50	(8.20)
Outer Conductor	ohms/1000ft (/km)	1.65	(5.4)
Voltage Withstand	Volts DC	2000	
Jacket Spark	Volts RMS	5000	
Peak Power	kW	10	

**Attenuation vs. Frequency (typical)**

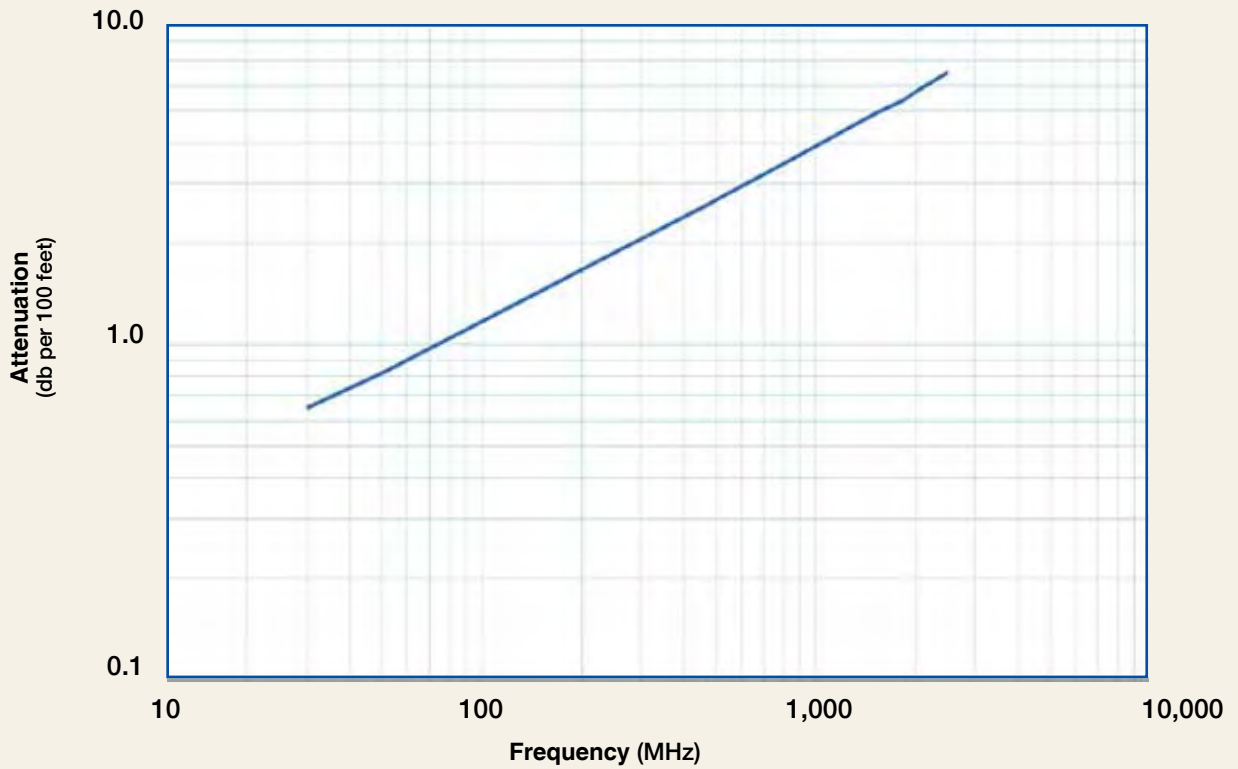

Frequency (MHz)	30	50	150	220	450	900	1500	1800	2000	2500
Attenuation dB/100 ft	0.6	0.8	1.5	1.8	2.6	3.7	4.9	5.4	5.7	6.4
Attenuation dB/100 m	2.1	2.7	4.8	5.8	8.4	12.1	16.0	17.6	18.7	21.1
Avg. Power kW	2.99	2.31	1.32	1.08	0.74	0.52	0.39	0.35	0.33	0.30

**Calculate Attenuation =**

$(0.115570) \cdot \sqrt{\text{FMHz}} + (0.000260) \cdot \text{FMHz}$  (interactive calculator available at [http://www.timesmicrowave.com/cable\\_calculators](http://www.timesmicrowave.com/cable_calculators))

**Attenuation:**

VSWR=1.0 ; Ambient = +25°C (77°F)

**Power:**

VSWR=1.0; Ambient = +40°C; Inner Conductor = 100°C (212°F); Sea Level; dry air; atmospheric pressure; no solar loading

# LMR<sup>®</sup>-400-75 Ohm Flexible Low Loss Coaxial Cable

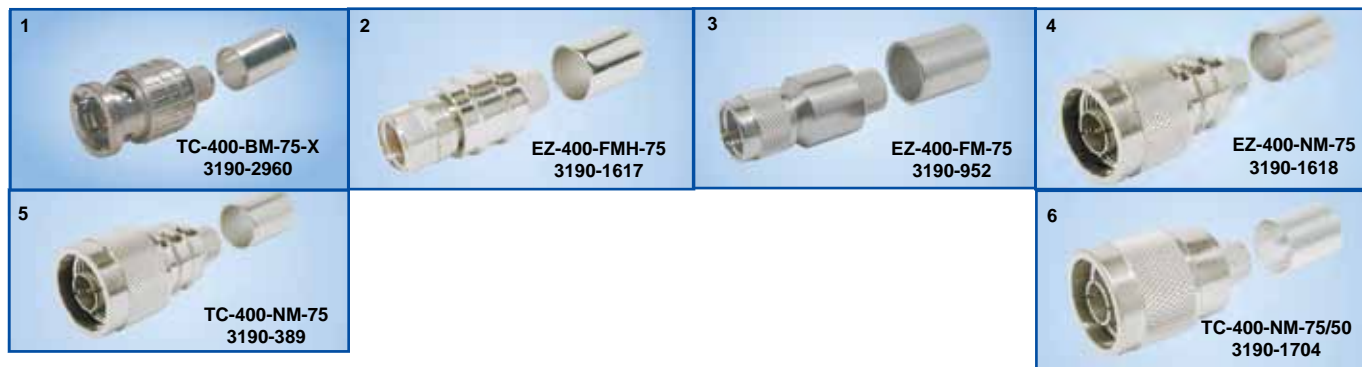

Connectors											
Interface	Description	Part Number	Stock Code	VSWR** Freq. (GHz)	Coupling Nut	Inner Contact Attach	Outer Finish* Contact Body /Pin		Length in (mm)	Width in (mm)	Weight lb (g)
1.	BNC Male Straight Plug	TC-400-BM-75-X	3190-2960	<1.1:1 (2.0)	Knurl	Solder-on	Crimp	N/G	1.37 (34.8)	0.56 (14.2)	0.043 (19.5)
2.	F Male Straight Plug	EZ-400-FMH-75	3190-1617	<1.25:1 (2.0)	Hex	Spring Finger	Crimp	N/G	1.7 (42.9)	0.49 (12.4)	0.02 (9.07)
3.	F Male Straight Plug	EZ-400-FM-75	3190-952	<1.25:1 (2.5)	Knurl	Spring Finger	Crimp	N/G	1.7 (43.2)	0.56 (14.2)	0.002 (9.1)
4.	N Male Straight Plug	EZ-400-NM-75	3190-1618	<1.25:1 (2.0)	Knurl	Spring Finger	Crimp	N/G	2.0 (50.5)	0.81 (20.6)	0.10 (45.36)
5.	N Male Straight Plug	TC-400-NM-75	3190-389	<1.25:1 (2.5)	Knurl	Solder	Crimp	N/G	1.5 (38.1)	0.83 (21.1)	0.90 (40.8)
6.	N Male Straight Plug	TC-400-NM-75/50***	3190-1704	<1.25:1 (2.0)	Knurl	Solder	Crimp	N/G	1.5 (38.1)	0.83 (21.1)	0.09 (39.01)

\* Finish metals: N=Nickel, S=Silver, G=Gold, SS=Stainless Steel, A=Alballoy \*\*VSWR spec based on 3 foot cable with a connector pair  
 \*\*\*NOTE: 75/50 suffix indicates the connector is for installation on 75 ohm LMR cable and mates with 50 ohm type-N connectors



## Install Tools

Type	Part Number	Stock Code	Description
Crimp Tool	CT-U	3192-181	Crimp Handle (Dies Required)
Crimp Dies	Y1719	3190-202	.429" Hex Dies
Crimp Tool	CT-400/300	3190-666	Crimp tool for LMR 400 connectors
Crimp Rings	CR-400	3190-830	Crimp rings for TC/EZ-400 connectors (package of 10)
Strip Tool	CST-400-75	3192-089	Combination prep tool for LMR-400-75 crimp and clamp connectors
Mid-Span Strip Tool	GST-400	3190-2174	For ground strap attachment
Deburr Tool	DBT-U	3192-001	Removes center conductor rough edges
Cutting Tool	CCT-02	3192-165	Cable end flush cut tool
Replacement Blade	RB-02	3192-166	Replacement blade for cutting tool
Replacement Blade Kit	RB-CST	3192-086	Replacement blade kit for all CST tools
Tool Kit	TK-400EZ-75	660-0084	Tool kit for LMR-400-75 crimp/clamp connectors includes, CCT-02,CST-400-75, CT-400/300, Tool Pouch)



## Hardware Accessories

Type	Part Number	Stock Code	Description
Ground Kit	GK-S400TT	GK-S400TT	Standard Grounding Kit (each)
Hoisting Grip	HG-400T	HG-400T	Laced Type (each)

## LMR<sup>®</sup>-600-75 Ohm Flexible Low Loss Coaxial Cable

### Ideal for...

- Satellite Applications
- Video Applications-CCTV, CATV, baseband or broadband
- In-Building Feeder Runs
- Any 75 ohm Wireless Application requiring an easily routed,



Part Description				
Part Number	Application	Jacket	Color	Stock Code
LMR-600-75	Indoor/Outdoor	PE	Black	54148
LMR-600-75-DB	Outdoor	PE	Black	54220
LMR-600-75-FR	Indoor	FRPE	Black	54258

Environmental Specifications		
Performance Property	°F	°C
Installation Temperature Range	-40/+185	-40/+85
Storage Temperature Range	-94/+185	-70/+85
Operating Temperature Range	-40/+185	-40/+85

Construction Specifications			
Description	Material	In.	(mm)
Inner Conductor	Solid BCCAl	0.108	(2.74)
Dielectric	Foam PE	0.455	(11.56)
Outer Conductor	Aluminum Tape	0.461	(11.71)
Overall Braid	Tinned Copper	0.490	(12.45)
Jacket	(See Table)	0.590	(14.99)

Mechanical Specifications			
Performance Property	Units	US	(metric)
Bend Radius: installation	in. (mm)	1.5	(38.1)
Bend Radius: repeated	in. (mm)	6.0	(152.4)
Bending Moment	ft-lb (N-m)	2.75	(3.73)
Weight	lb/ft (kg/m)	0.131	(0.20)
Tensile Strength	lb (kg)	350	(158.9)
Flat Plate Crush	lb/in. (kg/mm)	60	(1.07)

Electrical Specifications			
Performance Property	Units	US	(metric)
Max Operating Frequency	GHz	2.5	
Velocity of Propagation	%	87	
Dielectric Constant	NA	1.32	
Time Delay	nS/ft (nS/m)	1.17	(3.83)
Impedance	ohms	75	
Capacitance	pF/ft (pF/m)	15.6	(51.1)
Inductance	uH/ft (uH/m)	0.088	(0.29)
Shielding Effectiveness	dB	>90	
DC Resistance			
Inner Conductor	ohms/1000ft (/km)	1.39	(4.56)
Outer Conductor	ohms/1000ft (/km)	1.2	(3.9)
Voltage Withstand	Volts DC	4000	
Jacket Spark	Volts RMS	8000	
Peak Power	kW	40	

**Attenuation vs. Frequency (typical)**

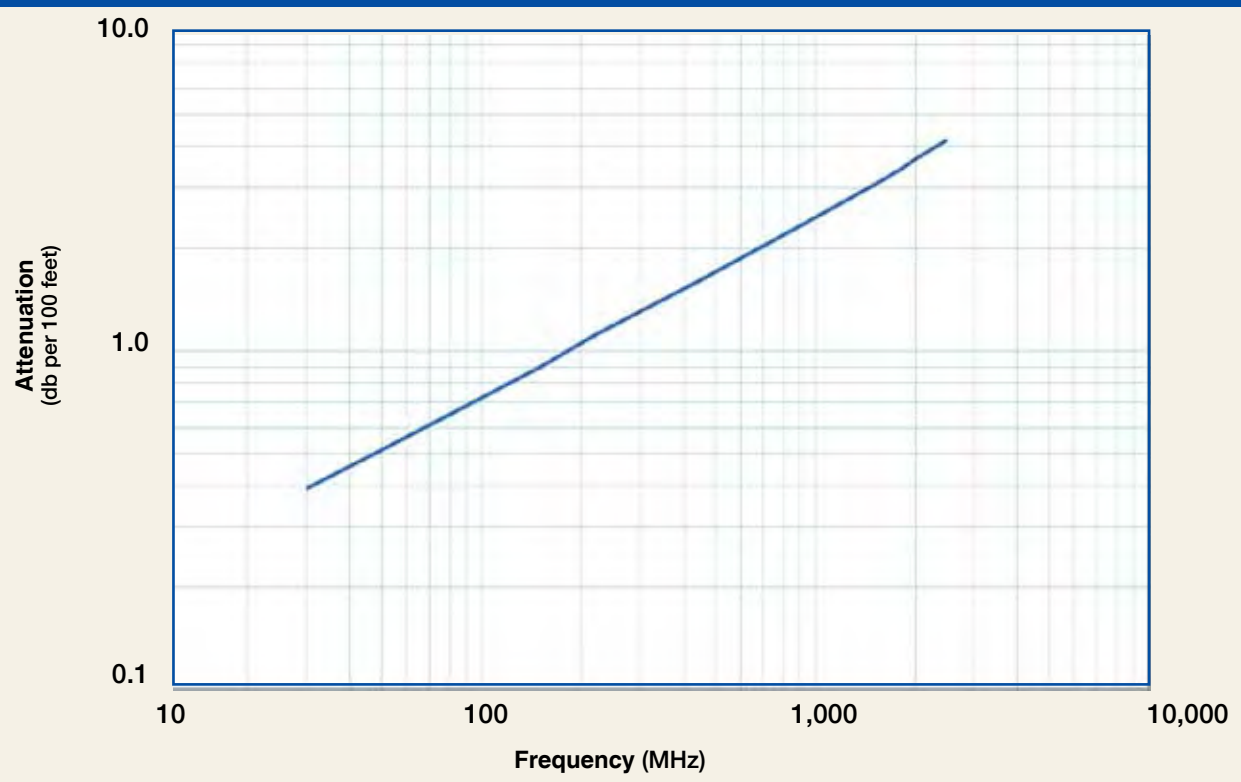

Frequency (MHz)	30	50	150	220	450	900	1500	1800	2000	2500
Attenuation dB/100 ft	0.4	0.5	0.9	1.1	1.6	2.3	3.1	3.5	3.7	4.2
Attenuation dB/100 m	1.3	1.7	3.0	3.6	5.3	7.7	10.2	11.4	12.1	13.7
Avg. Power kW	4.77	3.67	2.08	1.70	1.16	0.80	0.60	0.54	0.51	0.45

**Calculate Attenuation =**  
 $(0.070590) \cdot \sqrt{\text{FMHz}} + (0.000260) \cdot \text{FMHz}$  (interactive calculator available at [http://www.timesmicrowave.com/cable\\_calculators](http://www.timesmicrowave.com/cable_calculators))  
**Attenuation:**  
 VSWR=1.0 ; Ambient = +25°C (77°F)  
**Power:**  
 VSWR=1.0; Ambient = +40°C; Inner Conductor = 100°C (212°F); Sea Level; dry air; atmospheric pressure; no solar loading

# LMR-600-75 Ohm Flexible Low Loss Coaxial Cable



Connectors											
Interface	Description	Part Number	Stock Code	VSWR** Freq. (GHz)	Coupling Nut	Inner Contact Attach	Outer Contact Attach	Finish* Body /Pin	Length in (mm)	Width in (mm)	Weight lb (g)
1. F Male	Straight Plug	EZ-600-FMH-75	3190-1619	<1.25:1 (2.5)	Hex	Spring Finger Crimp		N/G	1.7 (43.2)	0.56(14.2)	0.112 (50.8)
2. N Male	Straight Plug	EZ-600-NM-75	3190-1620	<1.25:1 (2.0)	Knurl	Spring Finger Crimp		N/G	2.1 (53.1)	0.87(22.1)	0.166 (75)
3. N Male	Straight Plug	TC-600-NMH-75/50***	3190-1610	<1.25:1 (2.0)	Hex	Solder	Crimp	N/G	2.1 (53.1)	0.83(21.1)	0.166 (75)

\* Finish metals: N=Nickel, S=Silver, G=Gold, SS=Stainless Steel, A=Alloy \*\*VSWR spec based on 3 foot cable with a connector pair \*\*\*NOTE: 75/50 suffix indicates the connector is for installation on 75 ohm LMR cable and mates with 50 ohm type-N connectors

 <b>CT-U</b> 3192-181	 <b>CT-600</b> 3192-170	 <b>RB-CST</b> 3192-086
 <b>Y1720</b> 3190-203	 <b>CR-600</b> 3190-831	 <b>ST-600-75</b> 3192-090
 <b>DBT-U</b> 3192-001	 <b>GST-600A</b> 3190-1051	 <b>TK-600EZ-75</b> 660-0085
 <b>CCT-02</b> 3192-165	<h2>Install Tools</h2>	

Type	Part Number	Stock Code	Description
Crimp Tool	CT-U	3192-181	Crimp Handle (Dies Required)
Crimp Tool	CT-600	3192-170	Crimp tool for LMR-600 connectors
Crimp Dies	Y1720	3190-203	.610" Hex Dies
Crimp Rings	CR-600	3190-831	Crimp Rings for TC/EZ-600 connectors (pkg of 10)
Strip Tool	ST-600-75	3192-090	Strip tool for LMR-600-75 crimp and clamp style
Deburr Tool	DBT-U	3192-001	Removes center conductor rough edges
Midspan Strip Tool	GST-600A	3190-1051	For ground strap attachment
Cutting Tool	CCT-02	3192-165	Cable end flush cut tool
Replacement Blade	RB-02	3192-166	Replacement blade for cutting tool
Replacement Blade Kit	RB-CST	3192-086	Replacement blade for all CST strip tools
Tool Kit	TK-600EZ-75	660-0085	Tool kit for LMR-600 Crimp Connectors (includes CCT-02, ST-600-75, CT-600, Tool Pouch)



## Hardware Accessories

Type	Part Number	Stock Code	Description
Ground Kit	GK-S600TT	GK-S600TT	Standard Grounding Kit (each)
Hoisting Grip	HG-600T	HG-600T	Split/Laced Type (each)
Cold Shrink	CS-A600T	CS-A600T	Cable to Antenna Junction (each)
Cold Shrink	CS-60120T	CS-60120T	LMR-600 to -1200 Junction (each)
Cold Shrink	CS-60170T	CS-60170T	LMR-600 to -1700 Junction (each)
Stand. Entry Port Cushion	SC-600T-3	SC-600T-3	Three Cables (each)
Standard Entry Panels			Full Range of Port Styles/Combinations Available
Hanger Blocks	CB-600T	CB-600T	Dual Cable Support Block (kit of 10)
Hanger Block Supporting Hardware			Complete Range of Supporting Hardware & Adapters Available
Snap-In Hangers	SH-U600T	SH-U600T	Snap-In Hangers (Kit of 10)



## TCOM<sup>®</sup>-195 Low Loss Low Passive Intermod Coax

### Ideal for...

- -155 dBc Intermodulation Distortion
- Low Loss UHF/Microwave Interconnect
- Wireless Base Station Interconnect
- Flexible for Easy Routing

• **TCOM<sup>®</sup>** standard is a UV Resistant Polyethylene jacketed cable designed for 20-year service outdoor use. The bending and handling characteristics are significantly better than any air-dielectric and corrugated hard-line cables. **TCOM<sup>®</sup>-FR** is a non-halogen (non-toxic), low smoke, fire retardant cable designed for in-building runs that can be routed anywhere except air handling plenums. TCOM-FR has a UL/NEC & CSA rating of 'CMR' and 'FT4' respectively.

**Flexibility** and bendability are hallmarks of the TCOM cable design. The flexible outer conductor enables the tightest bend radius available for any cable of similar size and performance.

**Low Loss** is another hallmark feature of TCOM. Size for size LMR has the lowest loss of any flexible cable and comparable loss to semirigid hard-line cables.

**Passive Intermod** is lower than -155 dBc exceed the performance levels for most wireless applications.

**RF Shielding** is 60 dB greater than typical single shielded coax (40 dB). The multi-ply bonded foil outer conductor is rated conservatively at > 100 dB (i.e. >200 dB between two adjacent cables).

**Weatherability:** TCOM cables designed for outdoor exposure incorporate the best materials for UV resistance and have life expectancy in excess of 20 years.

**Connectors:** A wide variety of connectors are available for TCOM cable, including all common interface types, reverse polarity, and a choice of solder or non-solder center pins. Most LMR connectors employ crimp outer attachment using standard hex crimp sizes.

**Cable Assemblies:** All TCOM cable types are available as pre-terminated cable assemblies. Refer to the section on FlexTech for further details.

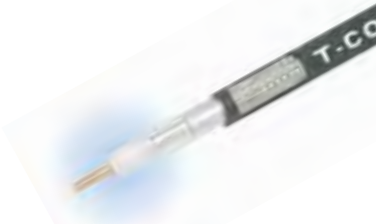

Part Description				
Part Number	Application	Jacket	Color	Stock Code
TCOM-195	Outdoor	PE	Black	55021
TCOM-195-FR	Indoor-Riser CMR	FRPE	Black	55012

Construction Specifications			
Description	Material	In.	(mm)
Inner Conductor	Solid BC	0.037	(0.94)
Dielectric	Foam PE	0.110	(2.79)
Outer Conductor	SPC Strip Braid	0.120	(3.05)
Overall Braid	TC Braid over Al tape	0.148	(3.76)
Jacket	(see table above)	0.195	(4.95)

Mechanical Specifications			
Performance Property	Units	US	(metric)
Bend Radius: installation	in. (mm)	0.5	(12.7)
Bend Radius: repeated	in. (mm)	2	(50.8)
Bending Moment	ft-lb (N-m)	0.2	(0.27)
Weight	lb/ft (kg/m)	0.035	(0.05)
Tensile Strength	lb (kg)	40	(18.2)
Flat Plate Crush	lb/in. (kg/mm)	15	(0.27)

Environmental Specifications		
Performance Property	°F	°C
Installation Temperature Range	-40/+185	-40/+85
Storage Temperature Range	-94/+185	-70/+85
Operating Temperature Range	-40/+185	-40/+85

Electrical Specifications			
Performance Property	Units	US	(metric)
Velocity of Propagation	%	76	
Dielectric Constant	NA	1.56	
Time Delay	nS/ft (nS/m)	1.27	(4.17)
Impedance	ohms	50	
Capacitance	pF/ft (pF/m)	25.4	(83.3)
Inductance	uH/ft (uH/m)	0.064	(0.21)
Shielding Effectiveness	dB	>100	
DC Resistance			
Inner Conductor	ohms/1000ft (/km)	7.6	(24.9)
Outer Conductor	ohms/1000ft (/km)	3.42	(11.2)
Voltage Withstand	Volts DC	1000	
Jacket Spark	Volts RMS	3000	
Peak Power	kW	2.5	
Passive Intermod	dBc	-155	

Attenuation vs. Frequency (typical)

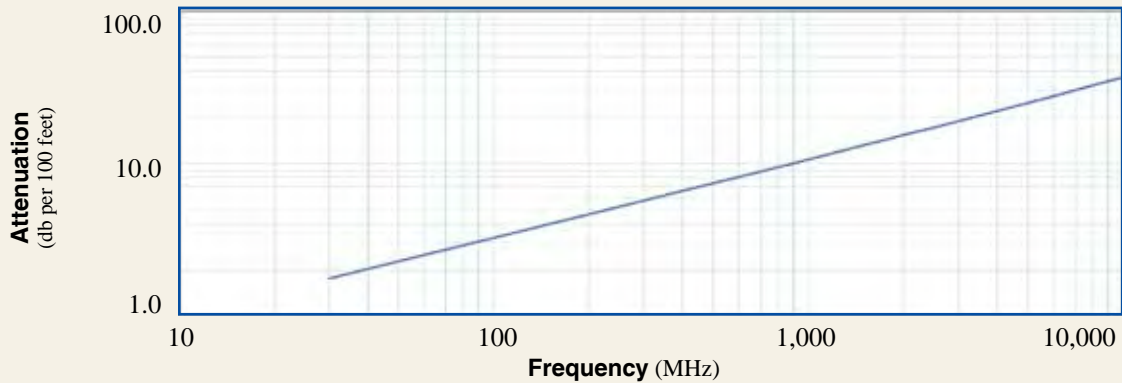

Frequency (MHz)	30	50	150	220	450	900	1500	1800	2000	2500	5800	10,000
Attenuation dB/100 ft	1.8	2.3	4.0	4.9	7.0	10.1	13.1	14.5	15.3	17.2	27.2	36.8
Attenuation dB/100 m	5.8	7.5	13.1	16.0	23.0	33.0	43.1	47.5	50.2	56.5	89.1	120.7
Avg. Power kW	0.91	0.71	0.40	0.33	0.23	0.16	0.12	0.11	0.10	0.09	0.06	0.04

Calculate Attenuation =  $(0.321011) \cdot \sqrt{\text{FMHz}} + (0.000469) \cdot \text{FMHz}$  (interactive calculator available at [http://www.timesmicrowave.com/cable\\_calculators](http://www.timesmicrowave.com/cable_calculators))  
**Attenuation:** VSWR=1.0; Ambient = +25°C (77°F) **Power:** VSWR=1.0; Ambient = +40°C; Inner Conductor = 100°C (212°F);  
 Sea Level; dry air; atmospheric pressure; no solar loading



**Connectors**

Interface	Description	Part Number	Stock Code	VSWR** Freq. (GHz)	Coupling Nut	Inner Contact Attach	Outer Contact Attach	Finish* Body /Pin	Length in (mm)	Width in (mm)	Weight lb (g)
1. N Male	Straight Plug	TC-195-NMH-X	3190-2880	<1.25:1 (2.5)	Knurl	Solder	Crimp	S/G	1.5 (38.1)	0.75 (19.1)	0.073 (33.1)
2. SMA Male	Straight Plug	EZ-195-SM-X	3190-6140	<1.30:1 (6)	Hex	Spring Finger	Crimp	A/G	0.9 (22.0)	0.37 (9.4)	0.019 (8.6)
3. SMA Male	Straight Plug	TC-195-SM-SS-X	3190-2878	<1.25:1 (2.5)	Hex	Solder	Crimp	SS/G	1.0 (25.4)	0.32 (8.1)	0.015 (6.8)
4. TNC Male	Straight Plug	TC-195-TM-X	3190-2879	<1.25:1 (2.5)	Knurl	Solder	Crimp	S/G	1.4 (35.6)	0.59 (15.0)	0.045 (20.4)
5. TNC Male	Reverse Polarity	EZ-195-TM-RP-X	3190-6142	<1.35:1 (6)	Hex	Spring Finger	Crimp	A/G	1.1 (28.3)	0.87 (22.0)	0.045 (20.4)
6. EZ-195-BM-X	BNC Male	EZ-195-BM-X	3190-6141	<1.30:1 (4)	Knurl	Spring Finger	Crimp	A/G	1.1 (28.4)	0.60 (14.5)	0.045 (20.4)

\* Finish metals: N=Nickel, S=Silver, G=Gold, SS=Stainless Steel, A=Alballoy \*\*VSWR spec based on 3 foot cable with a connector pair



Type	Part Number	Stock Code	Description	Install Tools
Crimp Tool	CT-240/200/195/100	3190-667	Crimp tool for LMR-100, 195, 200 and 240 connectors	
Deburr Tool	DBT-U	3192-001	Removes center conductor rough edges	
Cutting Tool	CCT-02	3192-165	Cable end flush cut tool	
Replacement Blade	RB-02	3192-166	Replacement blade for cutting tool	
Strip Tool	CST-195/200	3192-102	Combination prep tool for LMR-195 and LMR-200	
Replacement Blade Kit	RB-CST	3192-086	Replacement blade kit for all strip tools	

# TCOM<sup>®</sup>-200 Low Loss Low Passive Intermod Coax

Ideal for...

- -155 dBc Intermodulation Distortion
- Low Loss UHF/Microwave Interconnect
- Wireless Base Station Interconnect
- Flexible for Easy Routing



Part Description				
Part Number	Application	Jacket	Color	Stock Code
TCOM-200	Outdoor	PE	Black	55001
TCOM-200-FR	Indoor-Riser CMR	FRPE	Black	55022
TCOM-200-PUR-DB	Outdoor/ Watertight	PUR	Black	55042

Environmental Specifications			
Performance Property	°F	°C	
Installation Temperature Range	-40/+185	-40/+85	
Storage Temperature Range	-94/+185	-70/+85	
Operating Temperature Range	-40/+185	-40/+85	

Construction Specifications				
Description	Material	In.	(mm)	
Inner Conductor	Solid BC	0.044	(1.12)	
Dielectric	Foam PE	0.116	(2.95)	
Outer Conductor	SPC Strip Braid	0.126	(3.20)	
Overall Braid	TC Braid over Al tape	0.154	(3.91)	
Jacket	(see table)	0.195	(4.95)	

Mechanical Specifications				
Performance Property	Units	US	(metric)	
Bend Radius: installation	in. (mm)	0.5	(12.7)	
Bend Radius: repeated	in. (mm)	2	(50.8)	
Bending Moment	ft-lb (N-m)	0.2	(0.27)	
Weight	lb/ft (kg/m)	0.040	(0.06)	
Tensile Strength	lb (kg)	40	(18.2)	
Flat Plate Crush	lb/in. (kg/mm)	15	(0.27)	

Electrical Specifications				
Performance Property	Units	US	(metric)	
Velocity of Propagation	%	83		
Dielectric Constant	NA	1.45		
Time Delay	nS/ft (nS/m)	1.22	(4.02)	
Impedance	ohms	50		
Capacitance	pF/ft (pF/m)	24.5	(80.3)	
Inductance	uH/ft (uH/m)	0.061	(0.20)	
Shielding Effectiveness	dB	>100		
DC Resistance				
Inner Conductor	ohms/1000ft (/km)	5.36	(17.6)	
Outer Conductor	ohms/1000ft (/km)	3.84	(12.6)	
Voltage Withstand	Volts DC	1000		
Jacket Spark	Volts RMS	3000		
Peak Power	kW	2.5		
Passive Intermod	dBc	-155		

Attenuation vs. Frequency (typical)

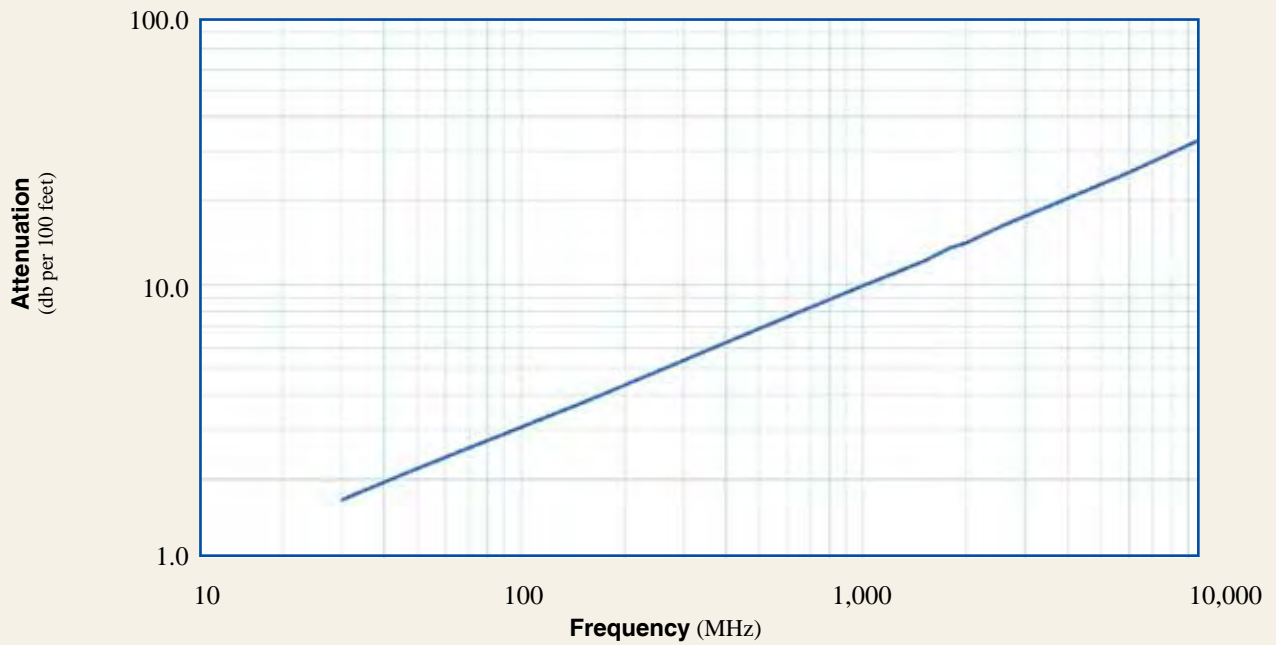

Frequency (MHz)	30	50	150	220	450	900	1500	1800	2000	2500	5800	10,000
Attenuation dB/100 ft	1.7	2.2	3.8	4.6	6.6	9.4	12.3	13.5	14.2	16.0	25.0	33.7
Attenuation dB/100 m	5.5	7.1	12.4	15.0	21.6	30.9	40.2	44.2	46.7	52.5	82.2	110.5
Avg. Power kW	1.08	0.84	0.48	0.39	0.27	0.19	0.15	0.13	0.13	0.11	0.07	0.05

Calculate Attenuation =  $(0.303670) \cdot \sqrt{\text{FMHz}} + (0.000331) \cdot \text{FMHz}$  (interactive calculator available at [http://www.timesmicrowave.com/cable\\_calculators](http://www.timesmicrowave.com/cable_calculators))  
 Attenuation: VSWR=1.0 ; Ambient = +25°C (77°F) Power: VSWR=1.0; Ambient = +40°C; Inner Conductor = 100°C (212°F);  
 Sea Level; dry air; atmospheric pressure; no solar loading

# TCOM-200

## Low Loss Low Passive Intermod Coax



Connectors												
Interface	Description	Part Number	Stock Code	VSWR** Freq. (GHz)	Coupling Nut	Inner Contact Attach	Outer Contact Attach	Finish* Body /Pin	Length in (mm)	Width in (mm)	Weight lb (g)	
1. BNC Male	Straight Plug	TC-200-BM	3190-225	<1.25:1 (2.5)	Knurl	Solder	Crimp	S/G	1.7 (43.2)	0.56 (14.2)	0.045 (20.4)	
2. Mini-UHF	Straight Plug	TC-200-MUHF	3190-444	<1.25:1 (2.5)	Knurl	Solder	Crimp	NG	1.1 (27.9)	0.45 (11.4)	0.015 (6.8)	
3. N Male	Straight Plug	EZ-200-NMH-X	3190-2886	<1.25:1 (8)	Knurl	Spring Fit	Crimp	S/G	1.5 (38.1)	0.75 (19.1)	0.073 (33.1)	
4. N Male	Straight Plug	EZ-200-NMH-D	3190-1918	<1.25:1 (8)	Hex/Knurl	Spring Fit	Crimp	A/G	1.5 (38.1)	0.75 (19.1)	0.073 (33.1)	
5. N Male	Straight Plug	TC-200-NM	3190-224	<1.25:1 (2.5)	Knurl	Solder	Crimp	S/G	1.5 (38.1)	0.75 (19.1)	0.073 (33.1)	
6. N Male	Reverse Polarity	TC-200-NM-RP	3190-959	<1.25:1 (2.5)	Knurl	Solder	Crimp	N/G	1.5 (38.1)	0.75 (19.1)	0.073 (33.1)	
7. SMA Male	Straight Plug	TC-200-SM-SS-X	3190-2881	<1.25:1 (8)	Hex	Solder	Crimp	SS/G	1.0 (25.4)	0.32 (8.1)	0.015 (6.8)	
8. SMA Male	Reverse Polarity	TC-200-SM-RP	3190-327	<1.25:1 (2.5)	Hex	Solder	Crimp	SS/G	1.0 (25.4)	0.32 (8.1)	0.015 (6.8)	
9. SMA Male	Right Angle	EZ-200-SM-RA-SS-X	3190-6006	<1.30:1 (6)	Hex	Spring Finger	Crimp	A/G	1.0 (24.7)	0.70 (17.7)	0.019 (8.6)	
10. SMA Female	Straight Jack	EZ-200-SF-SS-X	3190-6007	<1.25:1 (6)	NA	Spring Finger	Crimp	A/G	0.9 (23.2)	0.40 (10.0)	0.019 (8.6)	
11. TNC Female	Straight Jack	TC-200-TF	3190-263	<1.25:1 (2.5)	NA	Solder	Crimp	N/G	1.3 (33.0)	0.57 (14.5)	0.033 (15.0)	
12. TNC Female	Reverse Polarity	EZ-200-TF-RP	3190-793	<1.25:1 (2.5)	NA	Spring Fit	Crimp	A/G	1.3 (33.0)	0.57 (14.5)	0.033 (15.0)	
13. TNC Male	Right Angle	EZ-200-TM-RA-X	3190-6008	<1.25:1 (6)	Hex	Spring finger	Crimp	A/G	1.1 (27.5)	1.10 (28.8)	0.091 (41.7)	
14. TNC Male	Straight Plug	EZ-200-TM	3190-1266	<1.25:1 (2.5)	Knurl	Spring Fit	Crimp	S/G	1.4 (35.6)	0.59 (15.0)	0.045 (20.4)	
15. TNC Male	Straight Plug	TC-200-TMC	3190-240	<1.25:1 (2.5)	Knurl	Solder	Clamp	S/G	1.7 (43.2)	0.59 (15.0)	0.045 (20.4)	
16. TNC Male	Reverse Polarity	EZ-200-TM-RP	3190-792	<1.25:1 (2.5)	Knurl	Spring Fit	Crimp	A/G	1.4 (35.6)	0.32 (8.1)	0.045 (20.4)	

\* Finish metals: N=Nickel, S=Silver, G=Gold, SS=Stainless Steel, A=Alballoy \*\*VSWR spec based on 3 foot cable with a connector pair



## Hardware Accessories

Type	Part Number	Stock Code	Description
Ground Kit	GK-S200TT	GK-S200TT	Standard Ground Kit (each)



## Install Tools

Type	Part Number	Stock Code	Description
Crimp Tool	CT-240/200/195/100	3190-667	Crimp tool for LMR-100, 195, 200 and 240 connectors
Deburr Tool	DBT-U	3192-001	Removes center conductor rough edges
Cutting Tool	CCT-02	3190-165	Cable end flush cut tool
Replacement Blade	RB-02	3192-166	Replacement blade for cutting tool
Strip Tool	CST-195/200	3192-102	Combination prep tool for LMR-195 and LMR-200
Replacement Blade Kit	RB-CST	3192-086	Replacement blade kit for all strip tools

# TCOM<sup>®</sup>-240 Low Loss Low Passive Intermod Coax

Ideal for...

- -155 dBc Intermodulation Distortion
- Low Loss UHF/Microwave Interconnect
- Wireless Base Station Interconnect
- Flexible for Easy Routing



Part Description				Stock
Part Number	Application	Jacket	Color	Code
TCOM-240	Outdoor	PE	Black	55017
TCOM-240-FR	Indoor-Riser CMR	FRPE	Black	55023

Environmental Specifications		
Performance Property	°F	°C
Installation Temperature Range	-40/+185	-40/+85
Storage Temperature Range	-94/+185	-70/+85
Operating Temperature Range	-40/+185	-40/+85

Construction Specifications			
Description	Material	In.	(mm)
Inner Conductor	Solid BC	0.056	(1.42)
Dielectric	Foam PE	0.150	(3.81)
Outer Conductor	SPC Strip Braid	0.160	(4.06)
Overall Braid	TC Braid over Al tape	0.188	(4.78)
Jacket	(see table)	0.240	(6.10)

Mechanical Specifications			
Performance Property	Units	US	(metric)
Bend Radius: installation	in. (mm)	0.75	(19.1)
Bend Radius: repeated	in. (mm)	2.5	(63.5)
Bending Moment	ft-lb (N-m)	0.25	(0.34)
Weight	lb/ft (kg/m)	0.045	(0.07)
Tensile Strength	lb (kg)	80	(36.3)
Flat Plate Crush	lb/in. (kg/mm)	20	(0.36)

Electrical Specifications			
Performance Property	Units	US	(metric)
Velocity of Propagation	%	84	
Dielectric Constant	NA	1.42	
Time Delay	nS/ft (nS/m)	1.21	(3.97)
Impedance	ohms	50	
Capacitance	pF/ft (pF/m)	24.2	(79.4)
Inductance	uH/ft (uH/m)	0.060	(0.20)
Shielding Effectiveness	dB	>100	
DC Resistance			
Inner Conductor	ohms/1000ft (/km)	3.2	(10.5)
Outer Conductor	ohms/1000ft (/km)	2.06	(6.8)
Voltage Withstand	Volts DC	1500	
Jacket Spark	Volts RMS	5000	
Peak Power	kW	5.6	
Passive Intermod	dBc	-155	

Attenuation vs. Frequency (typical)

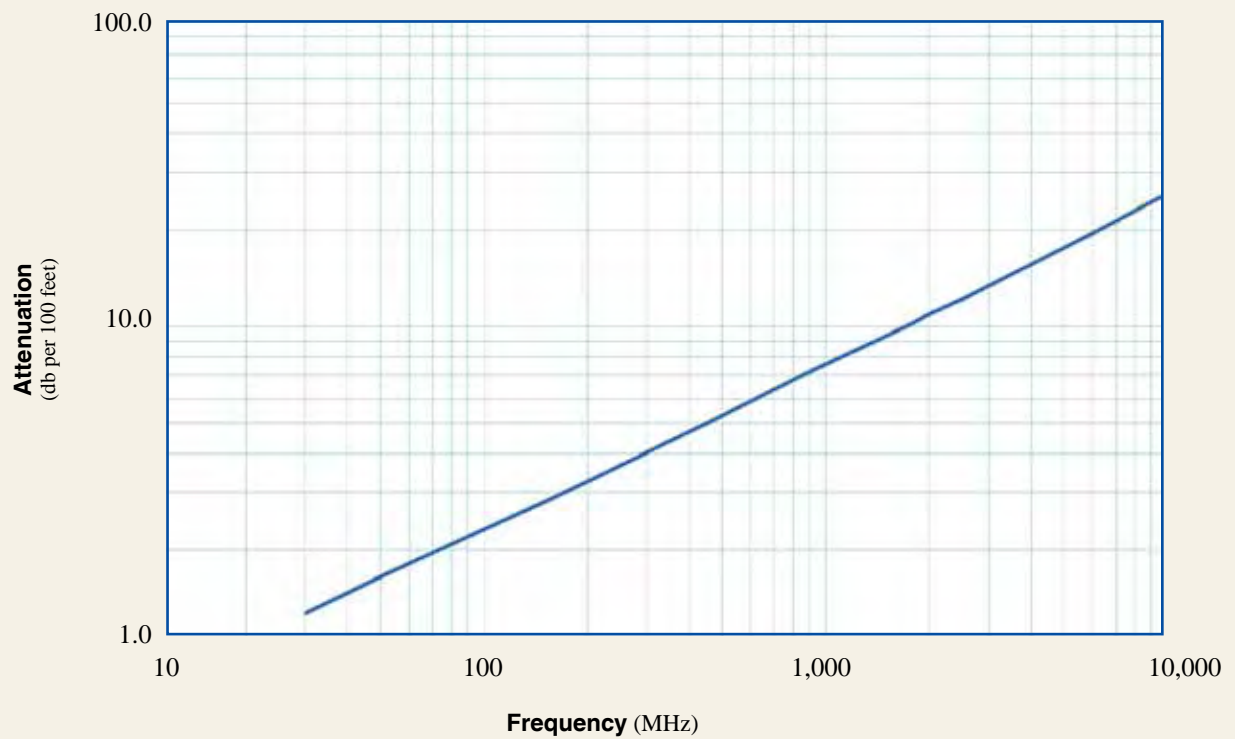

Frequency (MHz)	30	50	150	220	450	900	1500	1800	2000	2500	5800	10,000
<b>Attenuation dB/100 ft</b>	1.3	1.6	2.9	3.5	5.0	7.2	9.4	10.3	10.9	12.3	19.4	26.2
<b>Attenuation dB/100 m</b>	4.2	5.4	9.4	11.4	16.4	23.5	30.7	33.9	35.8	40.3	63.6	86.0
<b>Avg. Power kW</b>	1.58	1.22	0.70	0.57	0.40	0.28	0.21	0.19	0.18	0.16	0.10	0.07

**Calculate Attenuation =**

$(0.229148) \cdot \sqrt{\text{FMHz}} + (0.000331) \cdot \text{FMHz}$  (interactive calculator available at [http://www.timesmicrowave.com/cable\\_calculators](http://www.timesmicrowave.com/cable_calculators))

**Attenuation:**

VSWR=1.0 ; Ambient = +25°C (77°F)

**Power:**

VSWR=1.0; Ambient = +40°C; Inner Conductor = 100°C (212°F); Sea Level; dry air; atmospheric pressure; no solar loading



# TCOM-240 Low Loss Low Passive Intermod Coax



Connectors		Part Number	Stock Code	VSWR**	Frequency (GHz)	Coupling Nut	Inner Contact Attach	Outer Contact Attach	Finish* /Pin	Length in	Length (mm)	Width in	Width (mm)	Weight lb	Weight (g)
1. BNC Male	Straight Plug	TC-240-BMC	3190-242	<1.25:1	(2.5)	Knurl	Solder	Clamp	S/G	1.7	(43)	0.56	(14.2)	0.040	(18.1)
2. BNC Male	Straight Plug	TC-240-BM-X	3190-2890	<1.25:1	(2.5)	Knurl	Solder	Crimp	A/G	1.7	(43)	0.56	(14.2)	0.043	(19.5)
3. BNC Male	Straight Plug	EZ-240-BM-X	3190-6120	<1.25:1	(4)	Knurl	Spring Finger	Crimp	A/G	1.2	(31.7)	0.60	(14.5)	0.045	(20.4)
4. BNC Male	Right Angle	EZ-240-BM-RA-X	3190-2868	<1.30:1	(4)	Knurl	Spring Finger	Crimp	A/G	1.3	(33.6)	1.19	(30.1)	0.091	(41.7)
5. BNC Male	Right Angle	TC-240-BM-RA-X	3190-2869	<1.30:1	(4)	Knurl	Solder	Crimp	A/G	1	(25.1)	1.04	(26.4)	0.091	(41.7)
6. Mini-UHF	Straight Plug	TC-240-MUHF	3190-445	<1.25:1	(2.5)	Knurl	Solder	Crimp	N/G	1.1	(28)	0.45	(11.4)	0.014	(6.4)
7. N Male	Straight Plug	EZ-240-NMH-X	3190-2893	<1.25:1	(2.5)	Hex/Knurl	Spring Finger	Crimp	A/G	1.5	(38.1)	0.78	(19.8)	0.086	(39.0)
8. N Male	Straight Plug	TC-240-NMH-X	3190-2887	<1.25:1	(2.5)	Hex	Solder	Crimp	N/S	1.5	(38)	0.75	(19.1)	0.086	(39.0)
9. N Male	Right Angle	EZ-240-NMH-RA-X	3190-6143	<1.35:1	(6)	Hex	Spring Finger	Crimp	A/G	1	(25.1)	1.04	(26.4)	0.115	(52.0)
10. N Male	Straight Plug	TC-240-NMC	3190-244	<1.25:1	(2.5)	Knurl	Solder	Clamp	S/G	1.5	(38)	0.75	(19.1)	0.082	(37.2)
11. N Male	Right Angle	TC-240-NMH-RA-D	3190-2426	<1.35:1	(6)	Hex/Knurl	Solder	Crimp	A/G	1.2	(32.4)	1.22	(31.0)	0.091	(41.7)
12. N Female	Panel Jack	TC-240-NF-BHF(A)	3190-866	<1.25:1	(2.5)	NA	Solder	Crimp	A/G	1.7	(44)	1.00	(25.4)	0.115	(52.2)
13. N Female	Bulkhead Jack	TC-240-NF-BH-X	3190-2888	<1.25:1	(2.5)	NA	Solder	Clamp	A/G	1.8	(46)	0.88	(22.4)	0.145	(65.8)
14. N Female	Straight Jack	EZ-240-NF-X	3190-2795	<1.25:1	(6)	NA	Spring Finger	Crimp	A/G	1.4	(35.4)	0.62	(15.8)	0.040	(18.0)
15. SMA Female	Bulkhead Jack	TC-240-SFSS-BH-X	3190-2896	<1.25:1	(2.5)	NA	Solder	Crimp	SS/G	1.1	(29)	0.31	(7.9)	0.019	(8.6)
16. SMA Male	Straight Plug	TC-240-SM-SS-X	3190-2898	<1.25:1	(10)	Hex	Solder	Crimp	SS/G	1.0	(25)	0.32	(8.1)	0.016	(7.3)
17. SMA Male	Right Angle	TC-240-SM-RA-SS-X	3190-2900	<1.35:1	(6)	Hex	Solder	Crimp	SS/G	0.8	(20)	0.65	(16.5)	0.019	(8.6)
18. SMA Male	Reverse Polarity	TC-240-SM-RP	3190-326	<1.25:1	(2.5)	Hex	Solder	Crimp	SS/G	1.0	(25)	0.32	(8.1)	0.016	(7.3)
19. TNC Male	Straight Plug	EZ-240-TM	3190-1128	<1.25:1	(2.5)	Knurl	Spring Finger	Crimp	N/G	1.4	(34.3)	0.59	(15.0)	0.043	(19.5)
20. TNC Male	Straight Plug	TC-240-TM-X	3190-2797	<1.25:1	(2.5)	Knurl	Solder	Crimp	N/S	1.7	(43)	0.59	(15.0)	0.043	(19.5)
21. TNC Male	Reverse Polarity	EZ-240-TM-RP	3190-970	<1.25:1	(2.5)	Knurl	Spring Finger	Crimp	A/G	1.4	(36)	0.59	(15.0)	0.043	(19.5)
22. TNC Female	Straight Jack	EZ-240-TF-X	3190-6204	<1.25:1	(6)	NA	Spring Finger	Crimp	A/G	1.1	(27.2)	0.87	(22.0)	0.033	(15.0)
23. TNC Female	Reverse Polarity	EZ-240-TF-RP-X	3190-6167	<1.35:1	(6)	NA	Spring Finger	Crimp	A/G	1.1	(27.2)	0.87	(22.0)	0.033	(15.0)
24. F Male	Straight Plug	TC-240-FM-X	3190-2891	<1.25:1	(2.5)	Knurl	Solder	Crimp	N/G	1.1	(28)	0.45	(11.4)	0.014	(6.4)
25. QMA Male	Straight Plug	EZ-240-QM-X	3190-2894	<1.25:1	(6)	Knurl	Spring Finger	Crimp	N/G	1.2	(30.0)	0.41	(10.5)	0.014	(6.35)
26. QMA Male	Right Angle	EZ-240-QM-RA-X	3190-2895	<1.25:1	(<6)	Knurl	Spring Finger	Crimp	N/G	0.8	(20.3)	0.65	(16.5)	0.019	(8.62)

\* Finish metals: N=Nickel, S=Silver, G=Gold, SS=Stainless Steel, A=Alballoy \*\*VSWR spec based on 3 foot cable with a connector pair



## Hardware Accessories

Type	Part Number	Stock Code	Description
Ground Kit	GK-S240TT	GK-S240TT	Standard Ground Kit (each)



## Installation Tools

Type	Part Number	Stock Code	Description
Crimp Tool	CT-240/200/195/100	3190-667	Crimp tool for LMR-100, 195, 200 and 240 connectors
Strip Tool	CST-240A	3192-152	Prep tool for LMR-240 connectors
Deburr Tool	DBT-U	3192-001	Removes center conductor rough edges
Cutting Tool	CCT-02	3192-165	Cable end flush cut tool
Replacement Blade	RB-02	3192-166	Replacement blade for cutting tool
Replacement Blade Kit	RB-CST	3192-086	Replacement blade kit for all CST strip tools

# TCOM<sup>®</sup>-300 Low Loss Low Passive Intermod Coax



Ideal for...

- -155 dBc Intermodulation Distortion
- Low Loss UHF/Microwave Interconnect
- Wireless Base Station Interconnect
- Flexible for Easy Routing

Part Description					Stock
Part Number	Application	Jacket	Color	Code	Code
TCOM-300	Outdoor	PE	Black	55011	
TCOM-300-FR	Indoor-Riser CMR	FRPE	Black	55013	
TCOM-300-PUR-DB	Outdoor/Watertight	PUR	Black	55038	

Environmental Specifications			
Performance Property		°F	°C
Installation Temperature Range		-40/+185	-40/+85
Storage Temperature Range		-94/+185	-70/+85
Operating Temperature Range		-40/+185	-40/+85

Mechanical Specifications			
Performance Property	Units	US	(metric)
Bend Radius: installation	in. (mm)	0.88	(22.2)
Bend Radius: repeated	in. (mm)	3.0	(76.2)
Bending Moment	ft-lb (N-m)	0.38	(0.52)
Weight	lb/ft (kg/m)	0.055	(0.08)
Tensile Strength	lb (kg)	120	(54.5)
Flat Plate Crush	lb/in. (kg/mm)	30	(0.54)

Construction Specifications			
Description	Material	In.	(mm)
Inner Conductor	Solid BC	0.070	(1.78)
Dielectric	Foam PE	0.190	(4.83)
Outer Conductor	SPC Strip Braid	0.200	(5.08)
Overall Braid	TC Braid over Al tape	0.234	(5.94)
Jacket	(see table)	0.300	(7.62)

Electrical Specifications			
Performance Property	Units	US	(metric)
Velocity of Propagation	%	85	
Dielectric Constant	NA	1.38	
Time Delay	nS/ft (nS/m)	1.20	(3.92)
Impedance	ohms	50	
Capacitance	pF/ft (pF/m)	23.9	(78.4)
Inductance	uH/ft (uH/m)	0.060	(0.20)
Shielding Effectiveness	dB	>100	
DC Resistance			
Inner Conductor	ohms/1000ft (/km)	2.12	(7.0)
Outer Conductor	ohms/1000ft (/km)	2.10	(6.9)
Voltage Withstand	Volts DC	2000	
Jacket Spark	Volts RMS	5000	
Peak Power	kW	10	
Passive Intermod	dBc	-155	

Attenuation vs. Frequency (typical)

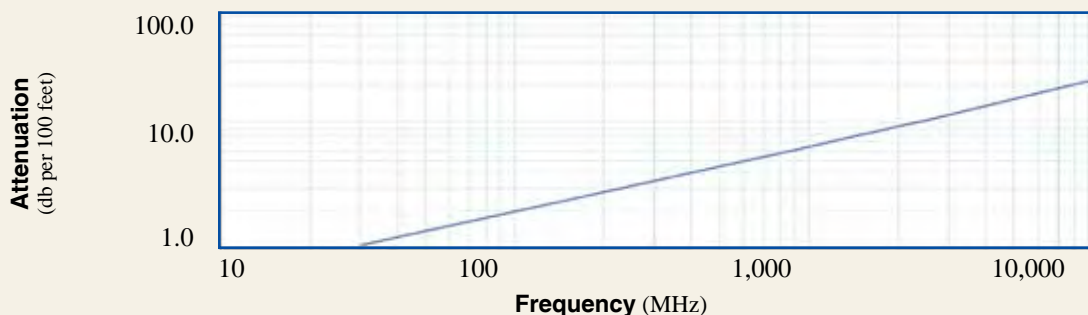

Frequency (MHz)	30	50	150	220	450	900	1500	1800	2000	2500	5800	10,000
Attenuation dB/100 ft	1.1	1.4	2.4	3.0	4.3	6.1	8.0	8.8	9.3	10.5	16.7	22.7
Attenuation dB/100 m	3.5	4.6	8.0	9.7	14.0	20.1	26.3	29.0	30.7	34.6	54.8	74.5
Avg. Power kW	2.07	1.60	0.91	0.75	0.52	0.36	0.28	0.25	0.24	0.21	0.13	0.10

Calculate Attenuation =  $(0.194337) \cdot \sqrt{\text{FMHz}} + (0.000327) \cdot \text{FMHz}$  (interactive calculator available at [http://www.timesmicrowave.com/cable\\_calculators](http://www.timesmicrowave.com/cable_calculators))  
 Attenuation: VSWR=1.0 ; Ambient = +25°C (77°F) Power: VSWR=1.0; Ambient = +40°C; Inner Conductor = 100°C (212°F);  
 Sea Level; dry air; atmospheric pressure; no solar loading



## Connectors

Interface	Description	Part Number	Stock Code	VSWR** Freq. (GHz)	Coupling Nut	Inner Contact Attach	Outer Contact Attach	Finish* Body /Pin	Length in (mm)	Width in (mm)	Weight lb (g)
1. TNC Male	Straight Plug	TC-300-TM	3190-500	<1.25:1 (2.5)	Knurl	Solder	Crimp	N/S	1.7 (43)	0.59 (15.0)	0.050 (22.7)
2. SMA Male	Straight Plug	TC-300-SM	3190-501	<1.25:1 (2.5)	Hex	Solder	Crimp	SS/G	1.0 (25)	0.35 (8.9)	0.018 (8.2)
3. SMA Female	Bulkhead Jack	TC-300-SF-BH	3190-590	<1.25:1 (2.5)	NA	Solder	Crimp	SS/G	1.1 (28)	0.31 (7.9)	0.022 (10.0)
4. N Male	Straight Plug	TC-300-NMH-X	3190-2861	<1.25:1 (6)	Hex/Knurl	Solder	Crimp	A/G	1.3 (33)	0.86 (21.8)	0.084(38.1)
5. N Male	Right Angle	TC-300-NMH-RA-D	3190-2761	<1.30:1 (2.5)	Hex/Knurl	Solder	Crimp	N/S	1.4 (35)	1.41 (35.8)	0.130 (59.0)
6. N Female	Straight Jack	EZ-300-NF-X	3190-3078	<1.25:1 (6)	NA	Spring Finger	Crimp	A/G	1.4 (36.5)	0.87 (22.0)	0.033 (18.0)

## Hardware Accessories

Type	Part Number	Stock Code	Description
Ground Kit	GK-S300TT	GK-S300TT	Standard Ground Kit (each)



## Install Tools

Type	Part Number	Stock Code	Description
Crimp Tool	CT-400/300	3190-666	Crimp tool for LMR 300 connectors
Deburr Tool	DBT-U	3192-001	Removes center conductor rough edges
Cutting Tool	CCT-02	3192-165	Cable end flush cut tool
Prep Tool	CST-300	3192-084	Prep tool for LMR-300 connectors
Replacement Blade	RB-02	3192-166	Replacement blade for cutting tool
Replacement Blade Kit	RB-CST	3192-086	Replacement blade kit for all strip tools



# TCOM<sup>®</sup>-400 Low Loss Low Passive Intermod Coax

## Ideal for...

- -155 dBc Intermodulation Distortion
- Low Loss UHF/Microwave Interconnect
- Wireless Base Station Interconnect
- Flexible for Easy Routing



Part Description				Stock
Part Number	Application	Jacket	Color	Code
TCOM-400	Outdoor	PE	Black	55003
TCOM-400-FR	Indoor-Riser CMR	FRPE	Black	55016
TCOM-400-PUR	Indoor/Outdoor	PUR	Black	55015
TCOM-400-PUR-DB	Outdoor/ Watertight	PUR	Black	55031

Construction Specifications			
Description	Material	In.	(mm)
Inner Conductor	Solid BCCAI	0.108	(2.74)
Dielectric	Foam PE	0.285	(7.24)
Outer Conductor	SPC Strip Braid	0.295	(7.49)
Overall Braid	TC Braid over Al tape	0.330	(8.38)
Jacket	(see table)	0.405	(10.29)

Environmental Specifications			
Performance Property		°F	°C
Installation Temperature Range		-40/+185	-40/+85
Storage Temperature Range		-94/+185	-70/+85
Operating Temperature Range		-40/+185	-40/+85

Electrical Specifications			
Performance Property	Units	US	(metric)
Velocity of Propagation	%	85	
Dielectric Constant	NA	1.38	
Time Delay	nS/ft (nS/m)	1.20	(3.92)
Impedance	ohms	50	
Capacitance	pF/ft (pF/m)	23.9	(78.4)
Inductance	uH/ft (uH/m)	0.060	(0.20)
Shielding Effectiveness	dB	>100	
DC Resistance			
Inner Conductor	ohms/1000ft (/km)	1.39	(4.6)
Outer Conductor	ohms/1000ft (/km)	1.47	(4.8)
Voltage Withstand	Volts DC	2500	
Jacket Spark	Volts RMS	8000	
Peak Power	kW	16	
Passive Intermod	dBc	-155	

Mechanical Specifications			
Performance Property	Units	US	(metric)
Bend Radius: installation	in. (mm)	1.00	(25.4)
Bend Radius: repeated	in. (mm)	4.0	(101.6)
Bending Moment	ft-lb (N-m)	0.5	(0.68)
Weight	lb/ft (kg/m)	0.080	(0.12)
Tensile Strength	lb (kg)	160	(72.6)
Flat Plate Crush	lb/in. (kg/mm)	40	(0.71)

**Attenuation vs. Frequency (typical)**

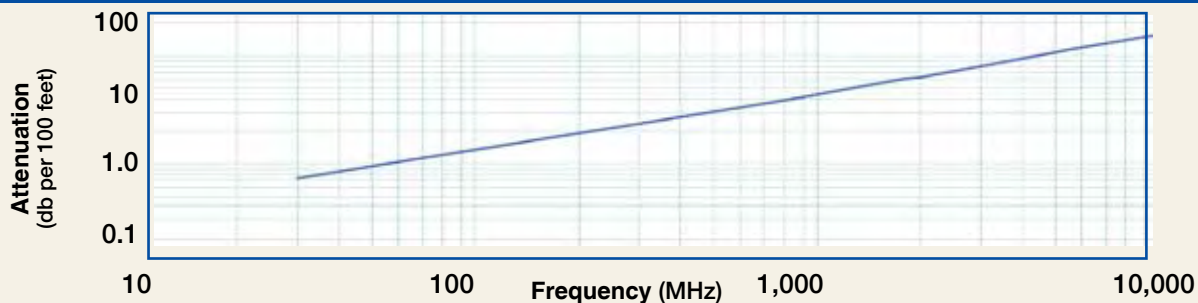

Frequency (MHz)	30	50	150	220	450	900	1500	1800	2000	2500	5800	10,000
Attenuation dB/100 ft	0.7	0.9	1.6	2.0	2.9	4.2	5.4	6.0	6.4	7.2	11.5	15.7
Attenuation dB/100 m	2.4	3.1	5.4	6.5	9.5	13.6	17.9	19.7	20.9	23.6	37.6	51.4
Avg. Power kW	3.12	2.41	1.38	1.13	0.78	0.54	0.41	0.37	0.35	0.31	0.19	0.14

1  EZ-400-4195M-X 3190-2969	2  TC-400-716FC 3190-376	3  TC-400-716MC 3190-279	4  TC-400-716M-X 3190-2597
5  TC-400-BM 3190-318	6  TC-400-BM-X 3190-6232	7  TC-400-MUHF 3190-520	8  TC-400-NFC 3190-299
9  EZ-400-NF-X 3190-2818	10  EZ-400-NF-BH 3190-518	11  TC-400-NFC-BH (A) 3190-872	12  SC-400-NM 3190-1454
13  TC-400-NMC 3190-277	14  EZ-400-NMH-X 3190-2590	15  TC-400-NMH-X 3190-2626	16  EZ-400-NMK 3190-661
17  EZ-400-NMH-RA-X 3190-2638	18  TC-400-NMC-RA (A) 3190-870	19  TC-400-NM-RP 3190-960	20  TC-400-SM 3190-439
21  TC-400-SF-X 3190-6174	22  EZ-400-TF-X 3190-3049	23  TC-400-TF-X 3190-3051	24  EZ-400-TF-RP 3190-795
25  EZ-400-TM-RP 3190-794	26  TC-400-TM-X 3190-2532	27  EZ-400-TM-X 3190-2533	28  TC-400-TM-RA-D 3190-2671

**Calculate Attenuation =**

$(0.130555) \cdot \sqrt{\text{FMHz}} + (0.000262) \cdot \text{FMHz}$  (interactive calculator available at [http://www.timesmicrowave.com/cable\\_calculators](http://www.timesmicrowave.com/cable_calculators))

**Attenuation:** VSWR=1.0 ; Ambient = +25°C (77°F)

**Power:** VSWR=1.0; Ambient = +40°C; Inner Conductor = 100°C (212°F);  
Sea Level; dry air; atmospheric pressure; no solar loading

# TCOM-400

## Low Loss Low Passive Intermod Coax



Connectors													
Interface	Description	Part Number	Stock Code	VSWR** Freq. (GHz)	Coupling Nut	Inner Contact Attach	Outer Contact Attach	Finish* Body /Pin	Length in (mm)	Width in (mm)	Weight lb (g)		
1. 4.1-9.5 mini DIN Male	Straight Plug	EZ-400-4195M-X	3190-2969	<1.25:1 (6)	Hex	Spring Finger	Crimp	A/G	1.5 (38.1)	0.89 (22.6)	0.103 (46.8)		
2. 7-16 DIN Female	Straight Jack	TC-400-716-FC	3190-376	<1.25:1 (2.5)	NA	Solder	Clamp	S/S	1.6 (41)	1.13 (28.7)	0.281 (127.5)		
3. 7-16 DIN Male	Straight Plug	TC-400-716-MC	3190-279	<1.25:1 (2.5)	Hex	Solder	Clamp	S/S	1.4 (36)	1.40 (35.6)	0.268 (121.6)		
4. 7-16 DIN Male	Straight Plug	TC-400-716M-X	3190-2597	<1.25:1 (6)	Hex	Solder	Crimp	A/S	1.6 (39.5)	1.42 (36.0)	0.320 (145.0)		
5. BNC Male	Straight Plug	TC-400-BM	3190-318	<1.25:1 (2.5)	Knurl	Solder	Crimp	N/S	1.7 (43)	0.56 (14.2)	0.063 (28.6)		
6. BNC Male	Straight Plug	TC-400-BM-X	3190-6232	<1.30:1 (4)	Knurl	Solder	Crimp	A/G	1.8 (46.8)	0.60 (14.5)	0.630 (28.6)		
7. Mini-UHF	Straight Plug	TC-400-MUHF	3190-520	<1.25:1 (2.5)	Knurl	Solder	Crimp	N/G	1.1 (28)	0.50 (12.7)	0.020 (9.1)		
8. N Female	Straight Jack	TC-400-NFC	3190-299	<1.25:1 (2.5)	NA	Solder	Clamp	N/S	1.6 (41)	0.75 (19.1)	0.119 (54.0)		
9. N Female	Straight Jack	EZ-400-NF-X	3190-2818	<1.25:1 (2.5)	NA	Spring Finger	Crimp	N/G	1.8 (45)	0.66 (16.8)	0.105 (47.6)		
10. N Female	Bulkhead Jack	EZ-400-NF-BH	3190-518	<1.25:1 (2.5)	NA	Spring Finger	Crimp	N/G	1.8 (46)	0.88 (22.4)	0.102 (46.3)		
11. N Female	Bulkhead Jack	TC-400-NFC-BH (A)	3190-872	<1.25:1 (2.5)	NA	Solder	Clamp	A/G	1.8 (46)	0.88 (22.4)	0.145 (65.8)		
12. N Male	Straight Plug	SC-400-NM	3190-1454	<1.25:1 (2.5)	Knurl	Solder	Crimp	N/G	1.5 (38)	0.75 (19.1)	0.090 (40.8)		
13. N Male	Straight Plug	TC-400-NMC	3190-277	<1.25:1 (2.5)	Knurl	Solder	Clamp	N/G	1.5 (38)	0.75 (19.1)	0.121 (54.9)		
14. N Male	Straight Plug	EZ-400-NMH-X	3190-2590	<1.25:1 (10)	Hex/Knurl	Spring Finger	Crimp	A/G	1.5 (38)	0.89 (22.6)	0.103 (46.8)		
15. N Male	Straight Plug	TC-400-NMH-X	3190-2626	<1.25:1 (10)	Hex/Knurl	Solder	Crimp	A/G	1.5 (38)	0.89 (22.6)	0.113 (51.3)		
16. N Male	Straight Plug	EZ-400-NMK	3190-661	<1.25:1 (10)	Knurl	Spring Finger	Crimp	S/G	1.5 (38)	0.89 (22.6)	0.113 (51.3)		
17. N Male	Right Angle	EZ-400-NMH-RA-X	3190-2638	<1.35:1 (6)	Hex/Knurl	Spring Finger	Crimp	A/G	1.87 (47)	1.42 (36.0)	0.177 (80.2)		
18. N Male	Right Angle	TC-400-NMC-RA (A)	3190-870	<1.35:1 (2.5)	Hex	Solder	Clamp	A/G	1.8 (46)	1.25 (31.8)	0.150 (68.0)		
19. N Male	Reverse Polarity	TC-400-NM-RP	3190-960	<1.25:1 (2.5)	Knurl	Solder	Crimp	N/G	1.5 (38)	0.75 (19.1)	0.090 (40.8)		
20. SMA Male	Straight Plug	TC-400-SM	3190-439	<1.25:1 (8)	Hex	Solder	Crimp	N/G	1.2 (29)	0.50 (12.7)	0.032 (14.5)		
21. SMA Female	Straight Jack	TC-400-SF-X	3190-6174	<1.35:1 (6)	NA	Solder	Crimp	A/G	1.2 (29.7)	0.50 (12.7)	0.026 (12.0)		
22. TNC Female	Straight Jack	EZ-400-TF-X	3190-3049	<1.25:1 (6)	NA	Solder	Crimp	A/G	1.8 (45.0)	0.55 (14.0)	0.074 (33.6)		
23. TNC Female	Straight Jack	TC-400-TF-X	3190-3051	<1.25:1 (6)	Knurl	Solder	Crimp	A/G	1.8 (46.8)	0.60 (14.5)	0.630 (28.6)		
24. TNC Female	Reverse Polarity	EZ-400-TF-RP	3190-795	<1.25:1 (2.5)	NA	Spring Finger	Crimp	A/G	1.8 (46)	0.55 (14.0)	0.074 (33.6)		
25. TNC Male	Reverse Polarity	EZ-400-TM-RP	3190-794	<1.25:1 (2.5)	NA	Spring Finger	Crimp	A/G	1.7 (43)	0.59 (15.0)	0.074 (33.6)		
26. TNC Male	Straight Plug	TC-400-TM-X	3190-2532	<1.25:1 (6)	Hex/Knurl	Solder	Crimp	A/G	1.9 (48)	0.67 (17.5)	0.075 (34.3)		
27. TNC Male	Straight Plug	EZ-400-TM-X	3190-2533	<1.25:1 (6)	Hex/Knurl	Spring Finger	Crimp	A/G	1.9 (48)	0.67 (17.5)	0.075 (34.3)		
28. TNC Male	Right Angle	TC-400-TM-RA-D	3190-2671	<1.35:1 (6)	Hex/Knurl	Solder	Crimp	A/G	1.4 (35)	1.41 (35.8)	0.130 (59.0)		
29. TNC Male	Reverse Polarity	TC-400-TM-RP-RA-D	3190-6147	<1.35:1 (6)	Hex	Solder	Crimp	A/G	1.4 (36.0)	1.20 (30.3)	0.130 (59.0)		
30. UHF Male	Straight Plug	EZ-400-UM	3190-997	<1.25:1 (2.5)	Knurl	Spring Finger	Crimp	N/G	1.9 (48)	0.80 (20.3)	0.090 (40.8)		
31. QN Female	Straight Jack	EZ-400-QNF-X	3190-2980	<1.25:1 (6)	NA	Spring Finger	Crimp	A/G	1.8 (45.0)	0.66 (16.8)	0.105 (47.6)		
32. QN Male	Straight Plug	EZ-400-QNM-X	3190-2979	<1.25:1 (6)	Hex	Spring Finger	Crimp	A/G	1.5 (38.1)	0.89 (22.6)	0.103 (46.8)		
33. QN Male	Right Angle	EZ-400-QNM-RA-X	3190-2981	<1.25:1 (6)	Hex	Spring Finger	Crimp	A/G	1.9 (47.0)	1.42 (36.0)	0.177 (80.2)		
34. QN Male	Straight Plug	TC-400-QNM-X	3190-6212	<1.25:1 (6)	Hex	Solder	Crimp	A/G	2.0 (50.2)	0.74 (18.9)	0.103 (46.8)		



## Hardware Accessories

Type	Part Number	Stock Code	Description
Ground Kit	GK-S400TT	GK-S400TT	Standard Grounding Kit (each)
Hoisting Grip	HG-400T	HG-400T	Laced Type (each)



## Install Tools

Type	Part Number	Stock Code	Description
Crimp Tool	CT-U	3192-181	Crimp Handle (Dies Required)
Crimp Dies	Y1719	3190-202	.429" Hex Dies
Crimp Tool	CT-400/300	3190-666	Crimp tool for LMR 400 connectors
Crimp Rings	CR-400	3190-830	Crimp rings for TC/EZ-400 connectors (package of 10)
Deburr Tool	DBT-U	3192-001	Removes center conductor rough edges
Cutting Tool	CCT-02	3192-165	Cable end flush cut tool
Strip Tool	CST-400	3192-004	Combination prep tool for TCOM-400 crimp and clamp style connectors
Replacement Blades	RB-02	3192-166	Replacement blades for cutting tool
Replacement Blade Kit	RB-CST	3192-086	Replacement blade kit for all CST strip tools
Tool Kit	TK-400EZ	3190-1602	Tool kit for crimp and clamp style connectors (includes CCT-02, CST-400, CT-400/300, Tool Pouch)



# TCOM<sup>®</sup>-500 Low Loss Low Passive Intermod Coax

## Ideal for...

- -155 dBc Intermodulation Distortion
- Low Loss UHF/Microwave Interconnect
- Wireless Base Station Interconnect
- Flexible for Easy Routing

Part Description				Stock
Part Number	Application	Jacket	Color	Code
TCOM-500	Outdoor	PE	Black	55004
TCOM-500-FR	Indoor-Riser CMR	FRPE	Black	55025

Environmental Specifications		
Performance Property	°F	°C
Installation Temperature Range	-40/+185	-40/+85
Storage Temperature Range	-94/+185	-70/+85
Operating Temperature Range	-40/+185	-40/+85

Electrical Specifications			
Performance Property	Units	US	(metric)
Velocity of Propagation	%	86	
Dielectric Constant	NA	1.35	
Time Delay	nS/ft (nS/m)	1.18	(3.88)
Impedance	ohms	50	
Capacitance	pF/ft (pF/m)	23.6	(77.5)
Inductance	uH/ft (uH/m)	0.059	(0.19)
Shielding Effectiveness	dB	>100	
DC Resistance			
Inner Conductor	ohms/1000ft (/km)	0.82	(2.7)
Outer Conductor	ohms/1000ft (/km)	1.32	(4.3)
Voltage Withstand	Volts DC	3000	
Jacket Spark	Volts RMS	8000	
Peak Power	kW	22	
Passive Intermod	dBc	-155	

Construction Specifications			
Description	Material	In.	(mm)
Inner Conductor	Solid BCCAI	0.142	(3.61)
Dielectric	Foam PE	0.370	(9.40)
Outer Conductor	SPC Strip Braid	0.380	(9.65)
Overall Braid	TC Braid over Al tape	0.415	(10.54)
Jacket	(see table)	0.500	(12.70)

Mechanical Specifications			
Performance Property	Units	US	(metric)
Bend Radius: installation	in. (mm)	1.25	(31.8)
Bend Radius: repeated	in. (mm)	5.0	(127.0)
Bending Moment	ft-lb (N-m)	1.75	(2.37)
Weight	lb/ft (kg/m)	0.120	(0.179)
Tensile Strength	lb (kg)	260	(118.0)
Flat Plate Crush	lb/in. (kg/mm)	50	(0.89)

## Attenuation vs. Frequency (typical)

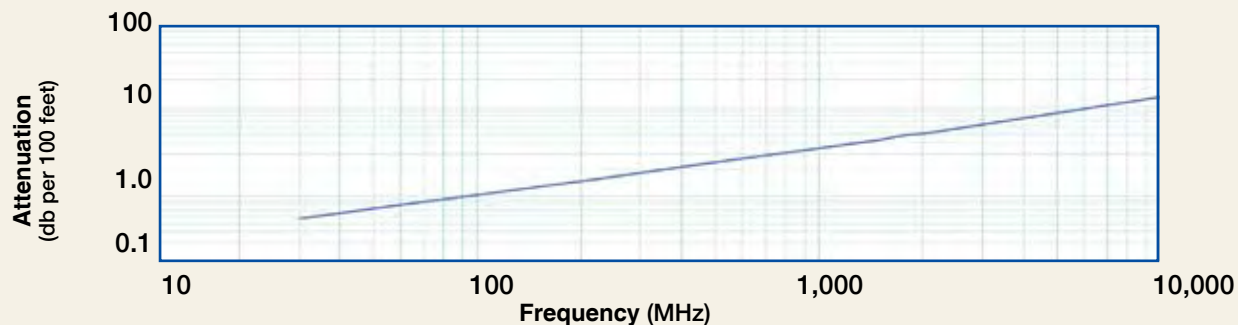

Frequency (MHz)	30	50	150	220	450	900	1500	1800	2000	2500	5800	10,000
Attenuation dB/100 ft	0.6	0.7	1.3	1.6	2.3	3.3	4.3	4.8	5.0	5.7	9.2	12.7
Attenuation dB/100 m	1.8	2.4	4.2	5.1	7.4	10.7	14.1	15.6	16.5	18.7	30.2	41.7
Avg. Power kW	4.21	3.25	1.85	1.52	1.04	0.72	0.55	0.49	0.47	0.41	0.25	0.18

Calculate Attenuation =  $(0.100972) \cdot \sqrt{\text{FMHz}} + (0.000262) \cdot \text{FMHz}$  (interactive calculator available at [http://www.timesmicrowave.com/cable\\_calculators](http://www.timesmicrowave.com/cable_calculators))  
 Attenuation: VSWR=1.0 ; Ambient = +25°C (77°F) Power: VSWR=1.0; Ambient = +40°C; Inner Conductor = 100°C (212°F);  
 Sea Level; dry air; atmospheric pressure; no solar loading



Connectors		Part Number	Stock Code	VSWR**	Coupling Nut	Inner Contact Attach	Outer Contact Attach	Finish* Body /Pin	Length in (mm)	Width in (mm)	Weight lb	Weight (g)
1.	7-16 DIN Female Straight Jack	TC-500-716F-X	3190-2906	<1.30:1 (6)	NA	Solder	Crimp	A/S	1.8 (45.9)	1.14 (29.0)	0.298	(135.0)
2.	7-16 DIN Male Right Angle	TC-500-716M-RA-D	3190-6079	<1.30:1 (6)	Hex	Solder	Crimp	A/S	1.8 (44.9)	1.60 (41.6)	0.370	(168.0)
3.	N Male Straight Plug	TC-500-NMH-X	3190-2514	<1.35:5 (6)	Hex/Knurl	Solder	Crimp	A/G	1.8 (45)	0.87 (22.0)	0.099	(45.0)
4.	N Male Right Angle	TC-500-NMH-RA-D	3190-2513	<1.25:1 (6)	Hex/Knurl	Solder	Crimp	A/G	1.5 (39)	1.6 (42.0)	0.279	(127.0)
5.	N Male Straight Plug	TC-500-NMC	3190-377	<1.25:1 (2.5)	Hex	Solder	Clamp	S/G	2.1 (53)	0.92 (23.4)	0.228	(103.4)
6.	N Male Right Angle	TC-500-NMC-RA	3190-227	<1.35:1 (2.5)	Hex	Solder	Clamp	S/G	2.4 (61)	1.5 (38.1)	0.275	(124.7)
7.	N Female Straight Jack	TC-500-NFC	3190-215	<1.25:1 (2.5)	NA	Solder	Clamp	S/G	2.2 (56)	0.94 (23.9)	0.215	(97.5)
8.	N Female Bulkhead Kit	BHA-KIT	3190-223	<1.25:1 (2.5)	NA	NA	NA	NA	NA	NA	0.014	(6.4)
9.	TNC Female Straight Jack	TC-500-TF-X	3190-6010	<1.30:1 (6)	NA	Solder	Crimp	A/G	1.8 (44.5)	0.87	22.0	0.077 (35.0)
10.	TNC Male Straight Plug	TC-500-TM	3190-464	<1.25:1 (2.5)	Hex	Solder	Crimp	N/G	1.5 (38)	0.62 (15.7)	0.082	(28.1)
11.	UHF Male Straight Plug	TC-500-UMC	3190-354	<1.25:1 (2.5)	Knurl	Solder	Clamp	S/G	2.1 (53)	0.88 (22.4)	0.215	(97.5)

\* Finish metals: N=Nickel, S=Silver, G=Gold, SS=Stainless Steel, A=Alballoy    \*\*VSWR spec based on 3 foot cable with a connector pair



## Install Tools

Type	Part Number	Stock Code	Description
Crimp Tool	CT-U	3192-181	Crimp Handle
Crimp Dies	Y151	3190-465	.532" Hex Dies
Cutting Tool	CCT-02	3192-165	Cable end flush cut tool
Prep Tool	CST-500	3192-075	Prep tool for LMR-500 crimp/clamp connectors
Replacement Blade	RB-02	3192-166	Replacement blade for cutting tool
Replacement Blade Kit	RB-CST	3192-086	Replacement blade kit for all CST tools



## TCOM<sup>®</sup>-600 Low Loss Low Passive Intermod Coax

### Ideal for...

- -155 dBc Intermodulation Distortion
- Low Loss UHF/Microwave Interconnect
- Wireless Base Station Interconnect
- Flexible for Easy Routing



Part Description				Stock
Part Number	Application	Jacket	Color	Code
TCOM-600	Outdoor	PE	Black	55005
TCOM-600-FR	Indoor-Riser CMR	FRPE	Black	55018
TCOM-600-PUR	Indoor/Outdoor	PUR	Black	55006
TCOM-600-PUR-DB	Outdoor/ Watertight	PUR	Black	55041

Construction Specifications			
Description	Material	In.	(mm)
Inner Conductor	Solid BCCAI	0.176	(4.47)
Dielectric	Foam PE	0.455	(11.56)
Outer Conductor	SPC Strip Braid	0.465	(11.81)
Overall Braid	TC Braid over Al tape	0.500	(12.70)
Jacket	(see table)	0.590	(14.99)

Environmental Specifications		
Performance Property	°F	°C
Installation Temperature Range	-40/+185	-40/+85
Storage Temperature Range	-94/+185	-70/+85
Operating Temperature Range	-40/+185	-40/+85

Mechanical Specifications			
Performance Property	Units	US	(metric)
Bend Radius: installation	in. (mm)	1.50	(38.1)
Bend Radius: repeated	in. (mm)	6.0	(152.4)
Bending Moment	ft-lb (N-m)	2.75	(3.73)
Weight	lb/ft (kg/m)	0.160	(0.24)
Tensile Strength	lb (kg)	350	(158.9)
Flat Plate Crush	lb/in. (kg/mm)	60	(1.07)

Electrical Specifications			
Performance Property	Units	US	(metric)
Velocity of Propagation	%	87	
Dielectric Constant	NA	1.32	
Time Delay	nS/ft (nS/m)	1.17	(3.83)
Impedance	ohms	50	
Capacitance	pF/ft (pF/m)	23.4	(76.6)
Inductance	uH/ft (uH/m)	0.058	(0.19)
Shielding Effectiveness	dB	>100	
DC Resistance			
Inner Conductor	ohms/1000ft (/km)	0.53	(1.74)
Outer Conductor	ohms/1000ft (/km)	1.52	(5.0)
Voltage Withstand	Volts DC	4000	
Jacket Spark	Volts RMS	8000	
Peak Power	kW	40	
Passive Intermod	dBc	-155	

**Attenuation vs. Frequency (typical)**

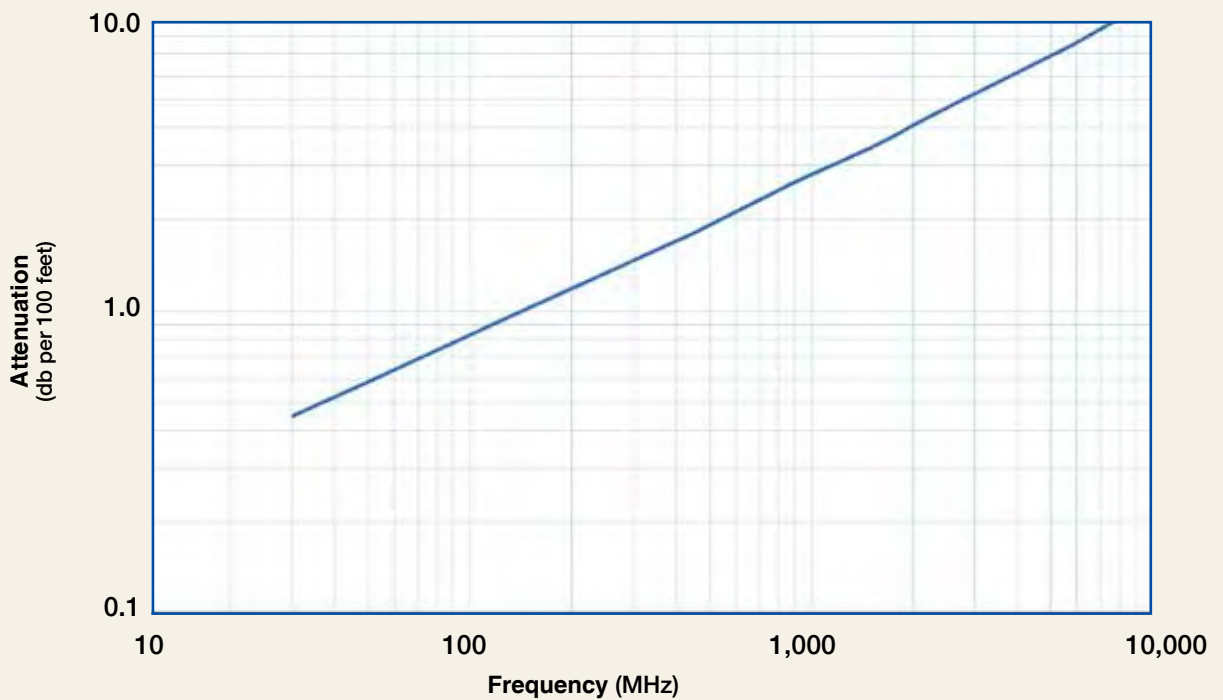

Frequency (MHz)	30	50	150	220	450	900	1500	1800	2000	2500	5800	10,000
<b>Attenuation dB/100 ft</b>	0.4	0.6	1.0	1.2	1.8	2.6	3.5	3.9	4.1	4.6	7.6	10.6
<b>Attenuation dB/100 m</b>	1.5	1.9	3.3	4.1	6.0	8.6	11.4	12.7	13.4	15.2	24.9	34.7
<b>Avg. Power kW</b>	5.20	4.01	2.28	1.86	1.28	0.88	0.66	0.60	0.56	0.50	0.30	0.22

**Calculate Attenuation =**

$(0.080075) \sqrt{\text{FMHz}} + (0.000256) \cdot \text{FMHz}$  (interactive calculator available at [http://www.timesmicrowave.com/cable\\_calculators](http://www.timesmicrowave.com/cable_calculators))

**Attenuation:**

VSWR=1.0 ; Ambient = +25°C (77°F)

**Power:**

VSWR=1.0; Ambient = +40°C; Inner Conductor = 100°C (212°F); Sea Level; dry air; atmospheric pressure; no solar loading

# TCOM-600 Low Loss Low Passive Intermod Coax



Connectors												
Interface	Description	Part Number	Stock Code	VSWR** Freq. (GHz)	Coupling Nut	Inner Contact Attach	Outer Contact Attach	Finish* Body /Pin	Length in (mm)	Width in (mm)	Weight lb	Weight (g)
1. 7-16 DIN Female	Straight Jack	TC-600-716-FC	3190-375	<1.25:1 (2.5)	NA	Solder	Clamp	S/S	1.1 (28)	1.00 (25.4)	0.249 (112.9)	
2. 7-16 DIN Male	Straight Plug	EZ-600-716-MH	3190-503	<1.25:1 (2.5)	Hex	Spring Finger	Crimp	S/S	2.0 (51)	1.30 (33.0)	0.254 (115.2)	
3. 7-16 DIN Male	Straight Plug	TC-600-716-MC	3190-502	<1.25:1 (2.5)	Hex	Solder	Clamp	S/S	2.0 (51)	1.30 (33.0)	0.347 (157.4)	
4. 7-16 DIN Male	Right Angle	TC-600-716M-RA	3190-395	<1.35:1 (2.5)	Hex	Solder	Crimp	S/S	1.4 (36)	1.40 (35.6)	0.354 (160.8)	
5. N Female	Bulkhead Jack	EZ-600-NF-BH	3190-616	<1.25:1 (2.5)	NA	Spring Finger	Crimp	S/G	2.4 (61)	0.88 (22.4)	0.195 (88.5)	
6. N Female	Bulkhead Jack	TC-600-NF-BH	3190-589	<1.25:1 (2.5)	NA	Solder	Crimp	S/G	2.4 (61)	0.88 (22.4)	0.195 (88.5)	
7. N Female	Bulkhead Jack	TC-600-NFC-BH	3190-466	<1.25:1 (2.5)	NA	Solder	Clamp	S/G	2.2 (56)	0.94 (23.9)	0.214 (97.1)	
8. N Male	Straight Plug	EZ-600-NMH-X	3190-2627	<1.25:1 (8.0)	Hex/Knurl	Spring Finger	Crimp	A/G	2.1 (53)	0.92 (23.4)	0.164 (74.4)	
9. N Male	Straight Plug	EZ-600-NMC-2-D	3190-2641	<1.25:1 (6)	Hex/Knurl	Spring Finger	Clamp	A/G	2.1 (53)	0.92 (23.4)	0.202 (91.6)	
10. N Male	Straight Plug	TC-600-NMC	3190-357	<1.25:1 (2.5)	Hex	Solder	Clamp	S/G	2.1 (53)	0.92 (23.4)	0.208 (93.4)	
11. N Male	Right Angle	TC-600-NMC-RA	3190-233	<1.35:1 (2.5)	Hex	Solder	Clamp	S/G	2.1 (53)	0.92 (23.4)	0.280 (127.0)	
12. TNC Male	Straight Plug	EZ-600-TM	3190-418	<1.25:1 (2.5)	Knurl	Spring Finger	Crimp	S/G	1.7 (43)	0.59 (15.0)	0.112 (50.8)	
13. TNC Male	Straight Plug	TC-600-TM-X	3190-2530	<1.25:1 (6)	Hex/Knurl	Solder	Crimp	A/G	2.3 (57.6)	0.75 (19.0)	0.100 (45.6)	
14. TNC Male	Straight Plug	EZ-600-TM-X	3190-2531	<1.25:1 (6)	Hex/Knurl	Spring Finger	Crimp	A/G	2.3 (57.6)	0.75 (19.0)	0.100 (45.6)	
15. BNC Male	Right Angle	TC-600-BM-RA	3190-2734	<1.30:1 (4)	Knurl	Solder	Crimp	A/G	1.8 (45.5)	1.54 (39.0)	0.164 (74.3)	
16. UHF Male	Straight Plug	EZ-600-UM	3190-615	<1.25:1 (2.5)	Knurl	Spring Finger	Crimp	S/G	1.7 (43)	0.88 (22.4)	0.164 (74.4)	
17. UHF Male	Straight Plug	TC-600-UMC	3190-213	<1.25:1 (2.5)	Knurl	Solder	Clamp	S/G	1.7 (43)	0.88 (22.4)	0.198 (89.8)	



## Accessories

Type	Part Number	Stock Code	Description
Ground Kit	GK-S600TT	GK-S600TT	Standard Grounding Kit (each)
Hoisting Grip	HG-600T	HG-600T	Split/Laced Type (each)
Cold Shrink	CS-A600T	CS-A600T	Cable to Antenna Junction (each)
Cold Shrink	CS-60120T	CS-60120T	LMR-600 to -1200 Junction (each)
Cold Shrink	CS-60170T	CS-60170T	LMR-600 to -1700 Junction (each)
Standard Entry Port Cushion	SC-600T-3	SC-600T-3	Three Cables (each)
Standard Entry Panels			Full Range of Port Styles/Combinations Available
Hanger Blocks	CB-600T	CB-600T	Dual Cable Support Block (kit of 10)
Hanger Block Supporting Hardware			Complete Range of Supporting Hardware & Adapters Available



## Install Tools











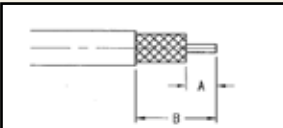

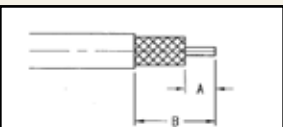
Type	Part Number	Stock Code	Description
Crimp Tool	CT-600	3192-170	Crimp tool for LMR-600 connectors
Crimp Tool	CT-U	3192-181	Crimp Handle (Dies Required)
Crimp Dies	Y1720	3190-203	Standard .610" Hex
Cutting Tool	CCT-02	3192-165	Cable and flush cut tool
Deburr Tool	DBT-U	3192-001	Removes center conductor rough edges
Replacement Blade Kit	RB-CST	3192-086	Replacement blade kit for all CST strip tools
Wrench	WR600	3190-1435	15/16" Box Wrench (2 required for EZ-600-NMC-2)
Strip Tool	CST-600	3192-052	Combination prep tool for T-COM 600 crimp/clamp connectors
Tool Kit	TK-600EZ	3190-1602	Tool kit for crimp/clamp connectors (includes CCT-02, CST-600, CT-600, Tool Pouch)

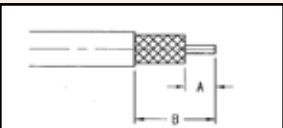

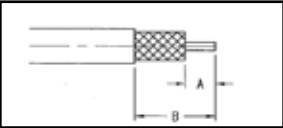

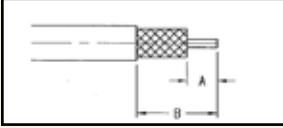

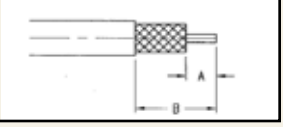

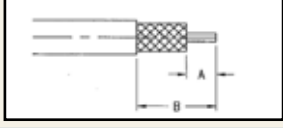

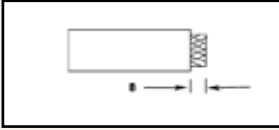
## Installation Tools

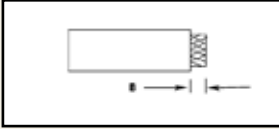
	Part Number	Stock Code	Description	Qty
<b>Crimp Tools</b>				
	CT-U	3192-181	Crimp Tool (handle only)	each
	CT-500	3192-169	Crimp tool for LMR-500 connectors	each
	CT-600	3192-170	Crimp tool for LMR-600 connectors	each
	Y197	3190-610	.213" hex dies fo TC/EZ-195/200 crimp connectors	each
	Y375	3190-608	.255" hex dies for TC/EZ-240 crimp connectors	each
	Y102	3190-611	.324" hex dies for TC/EZ-300 crimp connectors	each
	Y1719	3190-202	.429" hex dies for TC/EZ-400 crimp connectors	each
	Y151	3190-465	.532" hex dies for TC/EZ-500 crimp connectors	each
	Y1720	3190-203	.610" hex dies for TC/EZ-600 crimp connectors	each
	CT-400/300	3190-666	Crimp tool for LMR-400 & LMR-300 connectors	each
	CT-240/200/100	3190-667	Crimp tool for LMR-240, LMR-200, LMR195 & LMR-100 connectors	each
<b>Midspan Strip Tools</b>				
	GST-400A	3190-2174	Midspan strip tool for LMR-400 grounding kit	each
	GST-600A	3190-1051	Midspan strip tool for LMR-600 grounding kit	each
	GST-900A	3190-435	Midspan strip tool for LMR-900 grounding kit	each
	GST-1200A	3190-436	Midspan strip tool for LMR-1200 grounding kit	each
	GST-1700A	3190-437	Midspan strip tool for LMR-1700 grounding kit	each

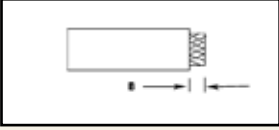
	Part Number	Stock Code	Description	Qty
<b>Deburring</b>				
	DBT-U	3192-001	Deburring tool for LMR-195 through LMR-600 center conductors	each
<b>Wrenches</b>				
	WR-600	3190-1435	15/16" box wrench (two required for EZ-600-NMC-2)	each
	WR-900	3190-509	1-1/4" box wrench (two required for EZ-900 connectors)	each
	WR-1200A	3190-512	1-9/16" box wrench (one required for EZ-1200 connectors)	each
	WR-1200B	3190-511	1-7/16" box wrench (one required for EZ-1200 connectors)	each
	WR-1700	3190-514	2" box wrench (two required for EZ-1700 connectors)	each
<b>Tool Kits</b>				
	TK-01	3190-731	Install tool kit for LMR-400/600 connectors (includes CCT-02, CST-400, CST-600, CT-U, .429 and .610 hex dies, tool pouch)	each
	TK-400EZ	3190-1601	Tool kit for LMR-400 crimp connectors (includes CCT-02, CST-400, CT-400/300, tool pouch)	each
	TK-600EZ	3190-1602	Tool kit for LMR-600 crimp connectors (includes CCT-02, CST-600, CT-600, tool pouch)	each
<b>Cable End Cutting Tools</b>				
	CCT-02	3192-165	Cable end flush cut tool (pkg of 1)	each
	RB-02	3192-166	Replacement blade for CCT-02	each

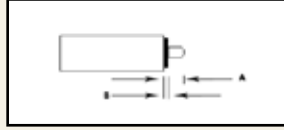

	Stock Code	Description	Diagram	A	B1	B2
 CST-195/200	3192-102	Prep tool for LMR-195/200 connectors		0.150"	0.550"	0.800"
 CST-240A	3192-152	Prep tool for LMR-240 connectors		0.200"	0.600"	0.800"
 CST-300	3192-084	Prep tool for LMR-300 connectors		0.250"	0.750"	1.000"
 CST-400	3192-004	Prep tool for LMR-400 crimp/clamp style connectors		0.210"	0.600"	0.800"
 ST-400C-2	3192-1972	Prep tool for EZ-400-NMC-2 & EZ-400-NFC-2 two piece clamp style connectors		0.250"	0.500"	N/A
 CST-500	3192-075	Prep tool for LMR-500 crimp/clamp style connectors		0.250"	0.580"	0.825
 CST-600	3192-052	Prep tool for LMR-600 crimp/clamp style connectors		0.250"	0.625"	1.000"

	Stock Code	Description	Diagram	A	B1	B2
 ST-900C	3190-1310	Prep tool for LMR-900 connectors		N/A	0.400"	N/A
 ST-1200-CH	3192-124	Prep tool for LMR-1200 connectors		N/A	0.400"	N/A
 ST-1700C	3190-312	Prep tool for LMR-1700 connectors		N/A	0.400"	N/A
 ST-396-J	3192-092	Prep tool for LMR-SW-396 connectors		8.5mm	2mm	N/A
 FT-396	3192-088	Flaring tool for LMR-SW-396 connectors				
 ST-540-J	3192-091	Prep tool for LMR-SW-540 connectors		8.5mm	2mm	N/A
 FT-540	3192-074	Flaring tool for LMR-SW-540 connectors				

### Mini Coax Support Blocks

	<p><i>Neatly stack coax into space saving bundles. Lower material cost by reducing hardware requirements.</i></p>	<p><b>Application:</b> Coax Support  <b>Size:</b> 1/2" to 1-1/4" coax  <b>Design:</b> Two-run block hangers  <b>Feature:</b> Compact coax bundles  <b>Mounts to:</b> 3/8" or 10mm threaded rod  <b>Material:</b> Long glass polypropylene  <b>Includes:</b> Blocks only  <b>Order Sep.:</b> 3/8" or 10mm mounting hardware kits</p>			
			TMS part no.	Quant/pkg.	Weight lb (kg)
	Mini coax support block for LMR-600	CB-600T	10	1.2	(0.5)
	Mini coax support block for LMR-900	CB-900T	10	1.2	(0.5)
	Mini coax support block for LMR-1200	CB-1200T	10	1.2	(0.5)
Mini coax support block for LMR-1700 coax	CB-1700T	10	1.7	(0.8)	

### Mounting Hardware Kits for Coax Support Blocks and Hanger Clamps

	<p><i>Pre-cut galvanized threaded rod hardware kits for stacking and installing mini coax support blocks.</i></p>	<p><b>Application:</b> Coax Support  <b>Size:</b> 3/8"  <b>Design:</b> 1, 2, and 3-stack threaded rod kits  <b>Feature:</b> Stacks coax blocks  <b>Mounts to:</b> —  <b>Material:</b> Galv. (3/8") or stainless steel (10mm)  <b>Includes:</b> Threaded rod and hardware  <b>Order Sep.:</b> Additional accessories</p>			
			TMS part no.	Quant/pkg.	Weight lb (kg)
	Hardware kit for LMR-600, 900, 1200 support blocks	HK-SSCB	10	1.8	(0.8)
	Hardware kit for LMR-1700 support blocks	HK-SSCB-158	10	1.9	(0.9)
	Hardware kit for mounting (2) mini coax support blocks for LMR-600, 900, 1200	HK-DSCB	10	2.3	(1.0)
	Hardware kit for mounting (2) mini coax support blocks for LMR-1700	HK-DSCB-158	10	2.5	(1.1)
	Hardware kit for mounting (3) mini coax support blocks for LMR-600, 900, 1200	HK-TSCB	10	2.8	(1.3)
	Hardware kit for mounting (3) mini coax support blocks for LMR-1700	HK-TSCB-158	10	3.2	(1.5)

### Adapter Bracket

	<p><i>Support coax blocks in wall mount applications.</i></p>	<p><b>Application:</b> Coax Support  <b>Size:</b> 7/16" (11.1mm) holes  <b>Design:</b> Adapts hangers to flat surfaces  <b>Feature:</b> Compact design  <b>Mounts to:</b> —  <b>Material:</b> Stainless steel  <b>Includes:</b> Bracket  <b>Order Sep.:</b> Additional accessories</p>			
			TMS part no.	Quant/pkg.	Weight lb (kg)
Adaptor bracket	AB-CB	10	4.6	(2.1)	

### Stainless Steel Adapter Bracket

	<p><i>Adapt angled members for securing coax cables. Unique design easily converts to accommodate snap-in hangers.</i></p>	<p><b>Application:</b> Coax Support  <b>Size:</b> 7/16" (11.1mm) holes  <b>Design:</b> Adapts hangers to flat surfaces  <b>Feature:</b> Fits any bolt-on hanger style  <b>Mounts to:</b> —  <b>Material:</b> Hot dip galv. steel,  <b>Includes:</b> Bracket  <b>Order Sep.:</b> Additional accessories</p>			
			TMS part no.	Quant/pkg.	Weight lb (kg)
Universal SST angle adapter	AB-CBH	1	2.3	(1.0)	

### Butterfly Hangers



*Butterfly hangers for standard non-snap-in installations.*

**Application:** Coax Support  
**Size:** see chart  
**Design:** Bolt-on single run hanger  
**Feature:** Traditional hanger solution  
**Mounts to:** 7/16" (11.1mm) prepunched hole  
**Material:** Stainless steel  
**Includes:** Hangers and set bolts  
**Order Sep.:** Hanger hardware kits & additional accessories  
**Note:** Hanger hardware kit not included; order separately

	TMS part no.	Quant/pkg.	Weight lb (kg)
Butterfly hanger for LMR-400	BH-S38 NH	10	1.0 (0.5)
Butterfly hanger for LMR-600	BH-12 NH	10	1.0 (0.5)
Butterfly hanger for LMR-900	BH-58 NH	10	1.1 (0.5)
Butterfly hanger for LMR-1200	BH-78 NH	10	1.1 (0.5)
Butterfly hanger for LMR-1700	BH-114 NH	10	1.4 (0.6)

### Standard Hangers



*Standard hanger for reduced installation time*

**App.:** Coax Support  
**Size:** See chart  
**Design:** Pre-formed bolt-on single run hanger  
**Feature:** Reduced installation time  
**Mounts to:** 7/16" (11.1mm) prepunched hole  
**Material:** Stainless steel  
**Includes:** Hangers and set bolts  
**Order Sep.:** Hanger hardware kits & additional accessories  
**Note:** Hanger hardware kit not included; order separately

	TMS part no.	Quant/pkg.	Weight lb (kg)
Standard hanger for LMR-400	BH-S38 NH	10	0.8 (0.4)
Standard hanger for LMR-600	BH-S12 NH	10	0.8 (0.4)
Standard hanger for LMR-1200	BH-S78 NH	10	1.8 (0.8)
Standard hanger for LMR-1700	BH-S114 NH	10	1.1 (0.5)

### Clip Hangers



*Easy install solution*

**Application:** Coax Support  
**Size:** See chart  
**Design:** Clip-on single run hanger  
**Feature:** Easy-to-install solution  
**Mounts to:** 7/16" (11.1mm) prepunched hole  
**Material:** Stainless steel  
**Includes:** Hangers and set bolts  
**Order Sep.:** Hanger hardware kits and additional accessories  
**Note:** Hanger hardware kit not included; order separately

	TMS part no.	Quant/pkg.	Weight lb (kg)
Clip hanger kit for LMR-600	CH-12 NH	10	0.8 (0.4)
Clip hanger kit for LMR-1200	CH-78 NH	10	0.8 (0.4)
Clip hanger kit for LMR-1700	CH-114 NH	10	1.1 (0.5)

### Universal Snap-in Hangers



*Snap-in hangers simplify coax installation by eliminating the need for mounting hardware and installation tools.*

**Application:** Coax Support  
**Size:** See chart  
**Design:** One-piece hanger solution  
**Feature:** Simplifies coax installation  
**Mounts to:** 3/4" (19.1mm) holes  
**Material:** Stainless steel  
**Includes:** Hangers  
**Order Sep.:** Additional mounting accessories

	TMS part no.	Quant/pkg.	Weight lb (kg)
Universal snap-in hanger for LMR-600	SH-U600T	10	0.7 (0.3)
Universal snap-in hanger for LMR-900	SH-U900T	10	1.0 (0.5)
Universal snap-in hanger for LMR-1200	SH-U1200T	10	1.2 (0.5)
Universal snap-in hanger for LMR-1700	SH-U1700T	10	1.3 (0.6)

### Hanger Hardware Kits

	<p><i>Standard, clip and butterfly for flange attachment.</i></p>	<p><b>Application:</b> Coax Support  <b>Size:</b> 3/8" or 10mm  <b>Design:</b> Hardware kit for hanger attachment to member  <b>Feature:</b> —  <b>Mounts to:</b> —  <b>Material:</b> Stainless steel  <b>Includes:</b> Bolts, nuts, lockwashers  <b>Order Sep.:</b> Hangers</p>			
			TMS part no.	Quant/pkg.	Weight lb (kg)
	Hanger hardware kit, 3/8" x 3/4" slotted hex head bolts, lock washers and hex nuts	HK-34-10	10	0.5	(0.2)
	Hanger hardware kit, 3/8" x 1" slotted head bolts lock washers and hex nuts	HK-100-10	10	0.6	(0.3)
Hanger hardware kit, 10mm x 20mm slotted head bolts lock washers and hex nuts	HK-M1020-10	10	0.5	(0.2)	

### Universal Angle Adapters

	<p><i>Adapt angled members for securing coax hangers.</i></p>	<p><b>Application:</b> Coax Support  <b>Size:</b> 3/4" (19.1mm) holes w/ 3/8" tapped insert  <b>Design:</b> Adapts hangers to angle members  <b>Feature:</b> Accepts snap-ins or 3/8" hardware  <b>Up to 7/8" (22mm) angle members</b>  <b>Material:</b> Stainless steel  <b>Includes:</b> Adapters, set bolt, hanger hardware kit, avail. w/ or wo insert  <b>Order Sep.:</b> Hangers</p>			
			TMS part no.	Quant/pkg.	Weight lb (kg)
	Universal angle adapter for snap-ins or 3/8" tapped holes	AA-U	10	4.9	(2.2)
	Angle adapter, large version, with 3/8" threaded hardware	AA-US	10	4.7	(2.1)

### Angle Adapters

	<p><i>Adapt angled members for securing coax hangers using 3/8" threaded hardware.</i></p>	<p><b>Application:</b> Coax Support  <b>Size:</b> 3/8" tapped holes  <b>Design:</b> Adapts hangers to angle members  <b>Feature:</b> High strength solution  <b>Mounts to:</b> Up to 7/8" (22mm) angle members  <b>Material:</b> Stainless steel  <b>Includes:</b> Adapters, set bolt, hanger hardware kit  <b>Order Sep.:</b> Hangers</p>			
			TMS part no.	Quant/pkg.	Weight lb (kg)
	Angle adapter with 3/8" tapped holes	AA-SL	10	5.4	(2.5)
	Angle adapter with 10 mm tapped holes	AA-SL-M10	10	5.4	(2.5)

### Stand-Off Adapters

	<p><i>Adapt and stand coax off 2" from round members. Unique design easily converts to accommodate snap-in hangers. Round member adapters included unless noted.</i></p>	<p><b>Application:</b> Coax Support  <b>Size:</b> 3/8" or 10mm tapped hole  <b>Design:</b> Adapts hangers to round members  <b>Feature:</b> Provides 2" (50.8mm) stand-off  <b>Mounts to:</b> Versions for 1" to 6" (25.4mm to 152.4mm) OD  <b>Material:</b> Stainless steel  <b>Includes:</b> Stand-offs, avail. w. or w.o. hose clamps  <b>Order Sep.:</b> Hangers</p>			
			TMS partno.	Quant/pkg.	Weight lb (kg)
	Universal SST stand-off adapter *	SA-38S	10	3.8	(1.7)
	Universal SST stand-off adapter for 1"-2" OD members**	SA-38S100	10	3.8	(1.7)
	Universal SST stand-off adapter for 2"-3" OD members**	SA-38S200	10	3.8	(1.7)
	Universal SST stand-off adapter for 3"-4" OD members**	SA-38S300	10	4.0	(1.8)
	Universal SST stand-off adapter for 4"-5" OD members**	SA-38S400	10	4.1	(1.9)
Universal SST stand-off adapter for 5"-6" OD members**	SA-38S500	10	4.4	(2.0)	

\* Round member adapters not included

\*\*Round adapter included

### Snap-In Stand-Off Adapters



*Adapt and stand coax off 2" from round members to avoid obstructions such as tower leg flanges and cross members*

**Application:** Coax Support  
**Size:** 3/4" (19.1mm) hole  
**Design:** Adapts hangers to round members  
**Feature:** Accepts snap-ins  
**Mounts to:** Versions for 1" to 6" (25.4mm to 152.4mm) OD  
**Material:** Stainless steel  
**Includes:** Stand-offs, avail. with or without hose clamps  
**Order Sep.:** Snap-ins

	TMS part no.	Quant/pkg.	Weight lb (kg)
Snap-In Stand-Off Adapter *	SA-SS	10	2.9 (1.3)
Snap-In Stand-Off Adapter for 1-2" (25.4mm-50.8mm) OD members**	SA-SS100	10	3.8 (1.7)
Snap-In Stand-Off Adapter for 2-3" (50.8mm-76.2mm) OD members**	SA-SS200	10	3.9 (1.8)
Snap-In Stand-Off Adapter for 3-4" (76.2mm-101.6mm) OD members**	SA-SS300	10	4.0 (1.8)
Snap-In Stand-Off Adapter for 4-5" (101.6mm-127.0mm) OD members**	SA-SS400	10	4.1 (1.9)
Snap-In Stand-Off Adapter for 5-6" (127.0mm-152.4mm) OD members**	SA-SS500	10	4.1 (1.9)

\* Round member adapters must be purchased separately \*\*Round member adapter included

### Mini Cluster Support Bracket



*Mini Cluster bracket provides compact mounting support for a variety of different hanger types*

**Application:** Coax Support  
**Size:** 3/4" (19.1mm) and 7/16" (11.1mm) holes  
**Design:** Three-run cluster bracket  
**Feature:** Compact mounting solution  
**Mounts to:** —  
**Material:** Hot dip galv. steel  
**Includes:** Bracket  
**Order Sep.:** Hangers, mounting hardware

	TMS part no.	Quant/pkg.	Weight lb (kg)
Mini Cluster Support Bracket	CS-BS	10	4.4 (2.0)

### Round Member Adapters



*Adapt round members when securing most hanger styles.*

**Application:** Coax Support  
**Size:** 3/4" (19.1mm) and 7/16" (11.1mm) holes  
**Design:** Three-run cluster bracket  
**Feature:** Compact mounting solution  
**Mounts to:** —  
**Material:** Hot dip galvanized steel  
**Includes:** Bracket  
**Order Sep.:** Hangers, mounting hardware

	TMS part no.	Quant/pkg.	Weight lb (kg)
Round member adapter, 1"-2" OD	RMA-100	10	0.8 (0.4)
Round member adapter, 2"-3" OD	RMA-200	10	1.0 (0.5)
Round member adapter, 3"-4" OD	RMA-300	10	1.2 (0.5)
Round member adapter, 4"-5" OD	RMA-400	10	1.3 (0.6)
Round member adapter, 5"-6" OD	RMA-500	10	1.3 (0.6)
Round member adapter, 6"-8" OD	RMA-600	10	1.3 (0.6)

**Lace-up Hoisting Grips**



*Hoisting Grips provide an effective method for lifting coax cables to the top of a tower where it is tied off to support the cable weight*

\*LMR-400 Grip is non-lace-up

Application: Coax Support  
 Size: Versions for coax and elliptical waveguide  
 Design: Mesh grip with single eye support  
 Feature: Lace-up installation at any point on coax  
 Mounts to: —  
 Material: Tinned bronze  
 Includes: Grip  
 Order Sep.: —

	TMS part no.	Quant/pkg.	Weight lb	(kg)
Hoisting Grip for LMR-400 Coaxial Cable*	HG-400T	1	0.3	(1.0)
Lace-up Hoisting Grip for LMR-600 Coaxial Cable	HG-600T	1	0.3	(1.0)
Lace-up Hoisting Grip for LMR-900 Coaxial Cable	HG-900T	1	0.4	(0.2)
Lace-up Hoisting Grip for LMR-1200 Coaxial Cable	HG-1200T	1	0.6	(0.3)
Lace-up Hoisting Grip for LMR-1700 Coaxial Cable	HG-1700T	1	0.6	(0.3)

**Universal Weatherproofing Kits**



*Mastic and electrical tape kit facilitates easy installation and provides a long-term environmental seal for connections.*

Application: Coax Protection  
 Size: —  
 Design: Tape kit for multi-layer wrap  
 Feature: Multi-connection protection  
 Mounts to: —  
 Material: Butyl and vinyl  
 Includes: WK-U

Includes: Six (6) rolls mastic, 2-1/2" x 24" (64mm x 610mm)  
 Two (2) rolls electrical tape, 3/4" x 66' (19mm x 20m)  
 One (1) roll electrical tape, 2" x 20' (51mm x 6m)

Order Sep.: —

	TMS part no.	Quant/pkg.	Weight lb	(kg)
Universal Kit (does 6 connections)	WK-U	1	3.4	(1.5)
Vinyl-mastic Kit (does 2 connections)	WK-2	1	0.6	(0.3)

**3M™ Cold Shrink™ Weatherproofing Kits**

*Avoid tapes and mastics with Cold Shrink™. This unique weatherproofing solution installs in less than three minutes, and eliminates the taping processes.*

	TMS part no.	Quant/pkg	Weight lb	(kg)
LMR-400 & LMR-600 (antenna interface)	CS-4060T	1	0.4	(0.2)
LMR-600 (antenna interface)	CS-A-600T	1	0.8	(0.4)
LMR-900 (antenna interface)	CS-A900T	1	0.8	(0.4)
LMR-1200 to LMR-400	CS-40120T	1	0.8	(0.4)
LMR-1200 to LMR-500	CS-50120T	1	0.8	(0.4)
LMR-1200 to LMR-600	CS-60120T	1	0.8	(0.4)
LMR-1200 to LMR-900	CS-90120T	1	0.8	(0.4)
LMR-1700 to LMR-400	CS-40170T	1	1.0	(0.5)
LMR-1700 to LMR-500	CS-50170T	1	1.0	(0.5)
LMR-1700 to LMR-600	CS-60170T	1	0.9	(0.4)
LMR-1700 to LMR-900	CS-90170T	1	0.9	(0.4)



**Weather Seal Strain Relief Boots**



The flexible silicone boot weatherproofing kits replace older weatherproofing methods, require no heat and only simple and easy hand assembly for valuable time saving in the field.

	TMS part no.	Quant/pkg
WSB-240 Weatherproofing/strain relief kit - LMR-240 crimp connectors	3109-400	10 pieces
WSB-400 Weatherproofing/strain relief kit - LMR-400 crimp connectors	3109-394	10 pieces
WSB-600 Weatherproofing/strain relief kit - LMR-600 crimp connectors	3109-401	10 pieces

### Rapid-Tite Self Bonding Silicone Tape



Self-bonding silicone tape is a cost effective, labor saving alternative to traditional vinyl mastic and butyl rubber sealing kits.

	TMS part no.	Quant/pkg	No. Connections
1.5" wide x 15' length x 30 mil. silicone tape	WK-S-1	1	6
	WK-S-2	2	12

### Standard Ground Kits



*Pre-formed copper strap facilitates easy installation and protects coax from lightning strikes in excess of 200 kA*

Application: Grounding  
 Size: Versions for coax and elliptical waveguide  
 Design: Bolt-on style with 3' (0.9m) lead / crimp lug  
 Feature: RoHS compliant  
 Mounts to: Coax outer conductor  
 Material: Tin plated copper strap  
 Includes: Ground kit, lug, weatherproofing kit

	TMS part no.	Quant/pkg.	Weight lb	(kg)
Standard Ground Kit for LMR-195 Coaxial Cable	GK-S195TT	1	1.4	(0.6)
Standard Ground Kit for LMR-200 Coaxial Cable	GK-S200TT	1	1.4	(0.6)
Standard Ground Kit for LMR-240 Coaxial Cable	GK-S240TT	1	1.4	(0.6)
Standard Ground Kit for LMR-300 Coaxial Cable	GK-S300TT	1	1.4	(0.6)
Standard Ground Kit for LMR-400 Coaxial Cable	GK-S400TT	1	1.4	(0.6)
Standard Ground Kit for LMR-500 Coaxial Cable	GK-S500TT	1	1.4	(0.6)
Standard Ground Kit for LMR-600 Coaxial Cable	GK-S600TT	1	1.4	(0.6)
Standard Ground Kit for LMR-900 Coaxial Cable	GK-S900TT	1	1.4	(0.6)
Standard Ground Kit for LMR-1200 Coaxial Cable	GK-S1200TT	1	1.4	(0.6)
Standard Ground Kit for LMR-1700 Coaxial Cable	GK-S1700TT	1	1.4	(0.6)

### 4" Feed-thru Entry Panels



*Traditional panel for weather-tight building penetration*

Application: Entry Port Solutions  
 Size: 20 configurations  
 Design: Entry plates with round ports  
 Feature: Easy to install solution  
 Mounts to: Walls  
 Material: Aluminum  
 Includes: Port, caps, mounting hardware  
 Order Sep.: 4" (101.6mm) Boot Assemblies

	TMS part no.	Quant/pkg.	Weight lb	(kg)
Entry Panel, 1 port, 1 x 1, standard	EP-220	1	1.0	(0.5)
Entry Panel, 1 port, 1 x 1, compact	EP-574	1	0.6	(0.3)
Entry Panel, 2 port, 1 x 2	EP-1448	1	2.3	(1.0)
Entry Panel, 3 port, 1 x 3	EP-1635	1	2.9	(1.3)
Entry Panel, 4 port, 1 x 4	EP-575	1	3.5	(1.6)
Entry Panel, 4 port, 2 x 2, standard	EP-1199	1	4.2	(1.9)
Entry Panel, 4 port, 2 x 2, compact	EP-1650	1	4.0	(1.8)
Entry Panel, 6 port, 2 x 3	EP-1449	1	6.1	(2.8)
Entry Panel, 6 port, 1 x 6	EP-1477	1	6.0	(2.7)
Entry Panel, 8 port, 2 x 4, standard	EP-576	1	6.1	(2.8)
Entry Panel, 8 port, 2 x 4, large	EP-1338	1	6.0	(2.7)
Entry Panel, 9 port, 3 x 3	EP-1033	1	7.1	(3.2)
Entry Panel, 10 port, 2 x 5	EP-1297	1	7.4	(3.4)
Entry Panel, 12 port, 3 x 4, standard	EP-1118	1	8.5	(3.9)
Entry Panel, 12 port, 3 x 4, large	EP-1334	1	7.0	(3.2)
Entry Panel, 12 port, 2 x 6	EP-1336	1	9.2	(4.2)
Entry Panel, 16 port, 4 x 4	EP-1447	1	9.1	(4.1)
Entry Panel, 18 port, 3 x 6	EP-1333	1	13.0	(5.9)
Entry Panel, 20 port, 4 x 5	EP-1861	1	11.0	(5.0)
Entry Panel, 24 port, 4 x 6	EP-1340	1	15.8	(7.2)

Note: Custom configurations available. Contact your sales administrator for details





**IPB Weather Proof Boots**

	IPB-400-NM	3109-417-1	LMR-400 Male IP boot suitable for type N, TNC, BNC, 4310, 4195
	IPB-400-NF	3109-417-2	LMR-400 Female IP boot suitable for type N, TNC, BNC, 4310, 4195
	IPB-400-NM-RA	3109-417-3	LMR-400 Male IP boot right angle suitable for type N, TNC, BNC, 4310, 4195
	IPB-600-NM	3109-417-4	LMR-600-NM Male IP boot suitable for type N, TNC, BNC, 4310, 4195
	IPB-600-NF	3109-417-5	LMR-600-NF Female IP boot suitable for type N, TNC, BNC, 4310, 4195
	IPB-600-NM-RA	3109-417-6	LMR-600-NM-RA Male IP boot right angle suitable for type N, TNC, BNC, 4310, 4195
	IPB-OR-NF	3109-417-7	Antenna port O-ring suitable for type N female
	IPB-250-NM	3109-417-8	SPO-250 (FSJ1) Male IP boot suitable for type N, TNC, BNC, 4310, 4195
	IPB-250-NM-RA	3109-417-9	SPO-250 (FSJ1) Male IP boot right angle suitable for type N, TNC, BNC, 4310, 4195
	IPB-250-DM	3109-417-10	SPO-250 (FSJ1) Male IP boot suitable for type DIN 7/16 connector
	IPB-250-DM-RA	3109-417-11	SPO-250 (FSJ1) Male IP boot right angle suitable for type DIN 7/16 connector

**IPB Weather Proof Boots**

	IPB-500-NM	3109-417-12	SPO-500 (FSJ1) Male IP boot suitable for type N, TNC, BNC, 4310, 4195
	IPB-500-NM-RA	3109-417-13	SPO-500 (FSJ1) Male IP boot right angle suitable for type N, TNC, BNC, 4310, 4195
	IPB-500-DM	3109-417-14	SPO-500 (FSJ1) Male IP boot suitable for type DIN 7/16 connector
	IPB-500-DM-RA	3109-417-15	SPO-500 (FSJ1) Male IP boot right angle suitable for type DIN 7/16 connector
	IPB-LPO-500-NM	3109-417-16	LPO-500 (LDF4) Male IP boot suitable for type N, TNC, BNC, 4310, 4195
	IPB-LPO-500-NM-RA	3109-417-17	LPO-500 (LDF4) Male IP boot right angle suitable for type N, TNC, BNC, 4310, 4195
	IPB-LPO-500-DM	3109-417-18	LPO-500 (LDF4) Male IP boot suitable for type DIN 7/16 connector
	IPB-LPO-500-DM-RA	3109-417-19	LPO-500 (LDF4) Male IP boot right angle suitable for type DIN 7/16 connector
	IPB-LPO-875-DF	3109-417-20	(LPO-875) AVA5-50FX DIN 7/16 universal boot
	IPB-OR-DF	3109-417-21	Antenna port O-ring IP boot for DIN 7/16 female
	Rubber Slide	3109-424	Lubricant for WSB and IPB boots

## Hardware Accessories

### Feed-Thru Boot Assemblies



<p><i>Innovative one-piece design simplifies installation. For use with EP-series feed-thru entry panels. Order cushion insert separately.</i></p>	<p>Application: Entry Port Solutions                  Size: 4" (101.6mm)                  Design: Compression boot for aluminum entry panels                  Feature: One-piece design simplifies installation                  Mounts to: Entry panels                  Material: EPDM rubber                  Includes: Boot, two hose clamps                  Order Sep.: Cushion Inserts, Entry Panel</p>			
	<p>TMS part no.      Quant/pkg.      Weight lb (kg)</p>			
<p>4" Boot assembly, cushion not included</p>	<p>BA-400</p>	<p>1</p>	<p>1.3</p>	<p>(0.6)</p>

### Cushion Inserts



<p><i>Standard port cushions are used with BA-400 boot assembly.</i></p>	<p>Application: Entry Port Solutions                  Size: Versions for coax and elliptical waveguide                  Design: Compression fit round cushions                  Feature: Dependable seal                  Mounts to: Feed-Thru Boot Assembly                  Material: EPDM rubber                  Includes: Cushion                  Order Sep.: Boot Assembly, Entry Panel</p>			
	<p>TMS part no.      Quant/pkg.      Weight lb (kg)</p>			
<p>Standard port cushion, blank (no holes)</p>	<p>SC-B</p>	<p>1</p>	<p>0.4</p>	<p>(0.2)</p>
<p>Standard port cushion with 6 holes for LMR-400 coax</p>	<p>SC-400T-6</p>	<p>1</p>	<p>0.4</p>	<p>(0.2)</p>
<p>Standard port cushion with 1 hole for LMR-600 coax</p>	<p>SC-600T-1</p>	<p>1</p>	<p>0.4</p>	<p>(0.2)</p>
<p>Standard port cushion with 2 holes for LMR-600 coax</p>	<p>SC-600T-2</p>	<p>1</p>	<p>0.4</p>	<p>(0.2)</p>
<p>Standard port cushion with 3 holes for LMR-600 coax</p>	<p>SC-600T-3</p>	<p>1</p>	<p>0.4</p>	<p>(0.2)</p>
<p>Standard port cushion with 4 holes for LMR-600 coax</p>	<p>SC-600T-4</p>	<p>1</p>	<p>0.4</p>	<p>(0.2)</p>
<p>Standard port cushion with 1 hole for LMR-900 coax</p>	<p>SC-900-1</p>	<p>1</p>	<p>0.4</p>	<p>(0.2)</p>
<p>Standard port cushion with 2 holes for LMR-900 coax</p>	<p>SC-900-2</p>	<p>1</p>	<p>0.4</p>	<p>(0.2)</p>
<p>Standard port cushion with 3 holes for LMR-900 coax</p>	<p>SC-900-3</p>	<p>1</p>	<p>0.4</p>	<p>(0.2)</p>
<p>Standard port cushion with 4 holes for LMR-900 coax</p>	<p>SC-900-4</p>	<p>1</p>	<p>0.4</p>	<p>(0.2)</p>
<p>Standard port cushion with 1 hole for LMR-1200 coax</p>	<p>SC-1200T-1</p>	<p>1</p>	<p>0.4</p>	<p>(0.2)</p>
<p>Standard port cushion with 2 holes for LMR-1200 coax</p>	<p>SC-1200T-2</p>	<p>1</p>	<p>0.4</p>	<p>(0.2)</p>
<p>Standard port cushion with 3 holes for LMR-1200 coax</p>	<p>SC-1200T-3</p>	<p>1</p>	<p>0.3</p>	<p>(0.1)</p>
<p>Standard port cushion with 1 hole for LMR-1700 coax</p>	<p>SC-1700T-1</p>	<p>1</p>	<p>0.3</p>	<p>(0.1)</p>

### Cushion Plugs



<p><i>Cushion plugs are used to fill unoccupied holes.</i></p>	<p>Application: Entry Port Solutions                  Size: 1/2" to 1-5/8" coax                  Design: Plugs for unused cushion holes                  Feature: Allows for future expansion                  Mounts to: Cushion Inserts                  Material: EPDM rubber                  Includes: Plugs                  Order Sep.: Cushion Inserts or Boot Assemblies</p>			
	<p>TMS part no.      Quant/pkg.      Weight lb (kg)</p>			
<p>Cushion plug for LMR-400 coax</p>	<p>CP-400T</p>	<p>5</p>	<p>0.2</p>	<p>(0.1)</p>
<p>Cushion plug for LMR-600 coax</p>	<p>CP-600T</p>	<p>5</p>	<p>0.2</p>	<p>(0.1)</p>
<p>Cushion plug for LMR-900 coax</p>	<p>CP-900T</p>	<p>5</p>	<p>0.3</p>	<p>(0.1)</p>
<p>Cushion plug for LMR-1200 coax</p>	<p>CP-1200T</p>	<p>5</p>	<p>0.3</p>	<p>(0.1)</p>
<p>Cushion plug for LMR-1700 coax</p>	<p>CP-1700T</p>	<p>5</p>	<p>0.5</p>	<p>(0.2)</p>

## Engineered Products

### FBT® Flexible Low Loss High Power

**Cable:** FBT® is a flexible low loss indoor/outdoor highly fire retardant cable suitable for use up to 150°C. Intended specifically for runs within and between base station cabinets, it can also be used in return air handling plenums or outdoors.

### FlexTech™ Commercial Cable

**Assemblies:** The use of higher frequencies for telecommunications applications has placed increasingly rigorous demands on cable assembly performance. Our 50 year plus background in military microwave assemblies has provided us the expertise to address these performance requirements, while our commercial expertise allows us to provide economical solutions. FlexTech™ jumper assemblies furnished standard with LMR-DB cable provide rugged dependability for any application.

### T-RAD™ 50 Ohm Leaky Feeder Cable:

T-RAD™ leaky feeder cables offer a cost effective solution to providing RF coverage in enclosed areas. The flexibility of the cable combined with quick attachment connectors, allows the cable to be easily installed, which is ideal for in-building applications.

**SilverLine™:** SilverLine™ Test Cables are cost effective, durable, high-performance cable assemblies designed for use in a broad range of test and interconnect applications. Fabricated from rugged, solid PTFE dielectric cable with stainless steel connectors and a proven strain relief system, these cables provide long life and excellent stability in applications where they are repeatedly flexed and mated/unmated. They are ideal for use in production, field and laboratory test environments. They are also economical enough to be used as interconnects in test systems.

**LMR Bundled Cable:** By bundling LMR® cables together under a common polyethylene outer jacket, this innovative design is the perfect solution for Smart Antenna and other sector applications. LMR® Bundled Cable greatly reduces the cost of installation by slashing the cost of labor and accessories compared to an installation using individual runs. LMR® Bundled Cable is supplied as a complete system, including weather seal breakout boots and ground kits with full technical support and custom tools, pictorial instructions and installation videos.

## Certified Installer Training Program

The LMR® Certified Installer Training Program covers all installation aspects of LMR coaxial transmission line cables, connectors and components, including grounding. Topics covered include:

- Coaxial cable fundamentals: characteristics, attenuation, return loss
- LMR coaxial cable designs, features and benefits
- Connectors
  - Various interfaces
  - EZ (non-solder) vs. TC (solder style) of center conductor attachment
  - Clamp vs. crimp style connector attachments
  - Impedance uniformity
  - Other characteristics
- Connector termination demonstrations (EZ and TC), using prep and installation tools on LMR-240, 400, 600 and 900 connectors and cables
- Attendee connector terminations
  - EZ-400-NMH-X (3190-2590)
  - EZ-400-NMH-RA-X (3190-2638)

- EZ-600-NMC-2 (3190-2641)
- EZ-900-NMC-2 (3190-1262)
- Attendees work with a full set of LMR tools and test assemblies they build for attenuation and return loss, using a hand held field analyzer
- Ground kit and weather sealing demonstrations
- SilverLine, QMA and TuffGrip demonstrations
- Radiating cable demonstrations
- LMR bundled cable with end cap and ground kit demonstrations

This one day program is available to groups of 10 or more and can be arranged through any Times distributor. It can be held at a location convenient to the group, at the Times Microwave location in Wallingford, Connecticut or at a participating Times distribution partner location. Attendees receive a certificate as a trained LMR installer. Contact your local Times representative for details.

Part #	Description
CITP	Certified Installer Training Program

**Engineered Products:**

**FBT™-195**

**Flexible Low Loss High Power Communications Coax**

**Ideal for...**

- High Power Base Station Jumper Assemblies
- In-Building Plenum Feeder Runs
- Any High Power Low Loss RF cable application



• **FBT™** is an indoor/outdoor highly fire retardant cable intended specifically for runs within and between base station cabinets. It is also applicable for return air handling plenums (e.g., dropped ceilings, raised floors). It has a UL/NEC rating of ‘CL2P’ for plenum applications.

• **Flexibility** and bendability are hallmarks of the FBT cable design. The flexible outer conductor enables the tightest bend radius available for any cable of similar size and performance.

• **Low Loss** is another hallmark feature of FBT. Size for size LMR has the lowest loss of any flexible cable and comparable loss to semirigid hard-line cables.

• **RF Shielding** is 50 dB greater than typical single shielded coax (40 dB). The multi-ply bonded foil outer conductor is rated conservatively at > 90 dB (i.e. >180 dB between two adjacent cables).

• **Weatherability:** FBT cables designed for outdoor exposure incorporate FEP jackets for UV resistance and have life expectancy in excess of 20 years.

• **Connectors:** A wide variety of connectors are available for FBT-195 cable, including all common interface types, reverse polarity, and a choice of solder or non-solder center pins. Most LMR connectors employ crimp outer attachment using standard hex crimp sizes.

• **Cable Assemblies** – All FBT cable types are available as pre-terminated cable assemblies. Refer the section on FlexTech for further details.

Construction Specifications			
Description	Material	In.	(mm)
Inner Conductor	Solid BC	0.037	(0.94)
Dielectric	Low Density PTFE	0.113	(2.87)
Outer Conductor	Aluminum Tape	0.119	(3.02)
Overall Braid	Tinned Copper	0.142	(3.61)
Jacket	Brown FEP	0.175	(4.45)

Mechanical Specifications			
Performance Property	Units	US	(metric)
Bend Radius: installation	in. (mm)	0.5	(12.7)
Bend Radius: repeated	in. (mm)	2	(50.8)
Bending Moment	ft-lb (N-m)	0.1	(0.14)
Weight	lb/ft (kg/m)	0.020	(0.03)
Tensile Strength	lb (kg)	40	(18.2)
Flat Plate Crush	lb/in. (kg/mm)	10	(0.19)

Environmental Specifications		
Performance Property	°F	°C
Installation Temperature Range	-67/+302	-55/+150
Storage Temperature Range	-67/+302	-55/+150
Operating Temperature Range	-67/+302	-55/+150

Electrical Specifications			
Performance Property	Units	US	(metric)
Velocity of Propagation	%	76	
Dielectric Constant	NA	1.73	
Time Delay	nS/ft (nS/m)	1.34	(4.40)
Impedance	ohms	50	
Capacitance	pF/ft (pF/m)	26.7	(87.6)
Inductance	uH/ft (uH/m)	0.067	(0.22)
Shielding Effectiveness	dB	>90	
DC Resistance			
Inner Conductor	ohms/1000ft (/km)	7.6	(24.9)
Outer Conductor	ohms/1000ft (/km)	4.90	(16.1)
Voltage Withstand	Volts DC	1000	
Jacket Spark	Volts RMS	3000	
Peak Power	kW	2.5	

Part Description					Stock
Part Number	Application	Jacket	Color	Code	
FBT-195	Indoor/Outdoor	FEP	Brown	54165	

Attenuation vs. Frequency (typical)

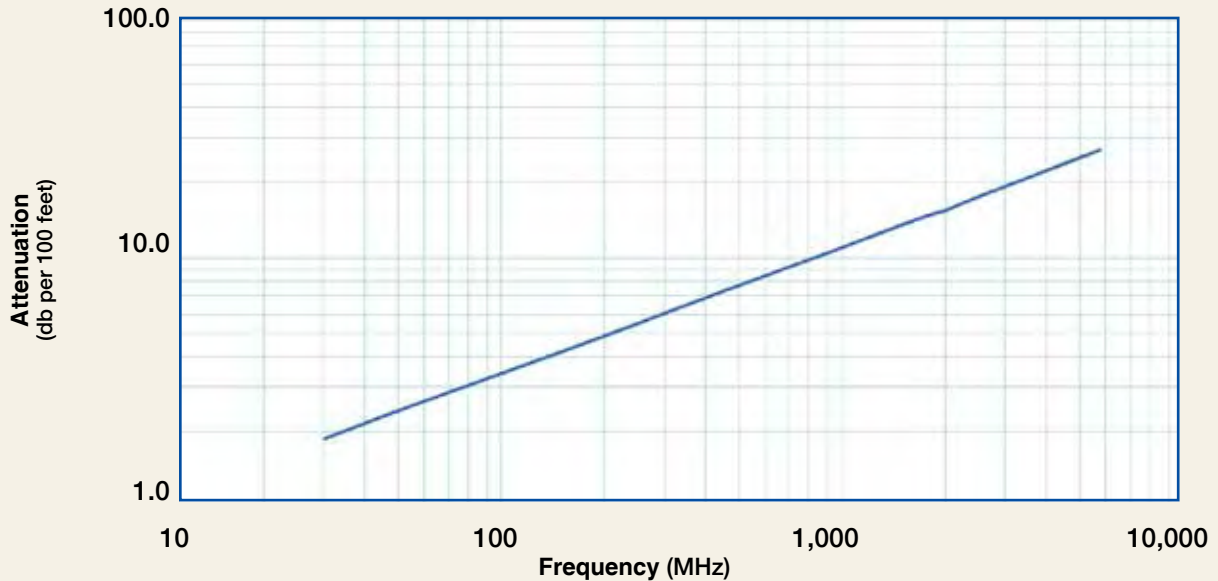

Frequency (MHz)	30	50	150	220	450	900	1500	1800	2000	2500	3400	5800
Attenuation dB/100 ft	2.0	2.5	4.4	5.3	7.8	10.9	14.1	15.4	16.3	18.3	21.4	28.2
Attenuation dB/100 m	6.4	8.3	14.4	17.5	25.1	35.6	46.2	50.7	53.5	60.0	70.2	92.5
Avg. Power kW	1.62	1.25	0.72	0.59	0.41	0.29	0.22	0.20	0.19	0.17	0.14	0.11

Calculate Attenuation =  $(0.340820) \cdot \sqrt{\text{FMHz}} + (0.000183) \cdot \text{FMHz}$  (interactive calculator available at [http://www.timesmicrowave.com/cable\\_calculators](http://www.timesmicrowave.com/cable_calculators))  
 Attenuation: VSWR=1.0 ; Ambient = +25°C (77°F) Power: VSWR=1.0; Ambient = +40°C; Inner Conductor = 100°C (212°F);  
 Sea Level; dry air; atmospheric pressure; no solar loading



**Connectors**

Interface	Description	Part Number	Stock Code	VSWR** Freq. (GHz)	Coupling Nut	Inner Contact Attach	Outer Contact Attach	Finish* Body /Pin	Length in (mm)	Width in (mm)	Weight lb (g)
1. N Male	Straight Plug	TC-195-NM	3190-1555	<1.25:1 (2.5)	Knurl	Solder	Crimp	S/G	1.5 (38.1)	0.75 (19.1)	0.073 (33.1)
2. SMA Male	Straight Plug	TC-195-SM	3190-1553	<1.25:1 (2.5)	Hex	Solder	Crimp	SS/G	1.0 (25.4)	0.32 (8.1)	0.015 (6.8)
3. TNC Male	Straight Plug	TC-195-TM	3190-1554	<1.25:1 (2.5)	Knurl	Solder	Crimp	S/G	1.4 (35.6)	0.59 (15.0)	0.045 (20.4)

\* Finish metals: N=Nickel, S=Silver, G=Gold, SS=Stainless Steel, A=Alballoy \*\*VSWR spec based on 3 foot cable with a connector pair



**Install Tools**

Type	Part Number	Stock Code	Description
Crimp Tool	CT-240/200/195/100	3190-667	Crimp tool for LMR-100,195, 200 and 240 connectors
Deburr Tool	DBT-U	3192-001	Removes center conductor rough edges
Cutting Tool	CCT-02	3192-165	Cable and flush cut tool
Replacement Blade	RB-02	3192-166	Replacement blade for cutting tool

**Engineered Products:**

**FBT™-200**

**Flexible Low Loss High Power Communications Coax**

**Ideal for...**

- High Power Base Station Jumper Assemblies
- In-Building Plenum Feeder Runs
- Any High Power Low Loss RF cable application



Part Description				Stock
Part Number	Application	Jacket	Color	Code
FBT-200	Indoor/Outdoor	FEP	Brown	54166

Environmental Specifications		
Performance Property	°F	°C
Installation Temperature Range	-67/+302	-55/+150
Storage Temperature Range	-67/+302	-55/+150
Operating Temperature Range	-67/+302	-55/+150

Construction Specifications			
Description	Material	In.	(mm)
Inner Conductor	Solid BC	0.040	(1.02)
Dielectric	Low Density PTFE	0.118	(3.00)
Outer Conductor	Aluminum Tape	0.123	(3.12)
Overall Braid	Tinned Copper	0.146	(3.71)
Jacket	Brown FEP	0.175	(4.45)

Mechanical Specifications			
Performance Property	Units	US	(metric)
Bend Radius: installation	in. (mm)	0.5	(12.7)
Bend Radius: repeated	in. (mm)	2	(50.8)
Bending Moment	ft-lb (N-m)	0.2	(0.27)
Weight	lb/ft (kg/m)	0.032	(0.05)
Tensile Strength	lb (kg)	30	(13.6)
Flat Plate Crush	lb/in. (kg/mm)	65	(1.169)

Electrical Specifications			
Performance Property	Units	US	(metric)
Velocity of Propagation	%	76	
Dielectric Constant	NA	1.73	
Time Delay	nS/ft (nS/m)	1.34	(4.40)
Impedance	ohms	50	
Capacitance	pF/ft (pF/m)	26.7	(87.6)
Inductance	uH/ft (uH/m)	0.067	(0.22)
Shielding Effectiveness	dB	>90	
DC Resistance			
Inner Conductor	ohms/1000ft (/km)	6.50	(21.3)
Outer Conductor	ohms/1000ft (/km)	4.90	(16.1)
Voltage Withstand	Volts DC	1000	
Jacket Spark	Volts RMS	3000	
Peak Power	kW	2.5	

Attenuation vs. Frequency (typical)

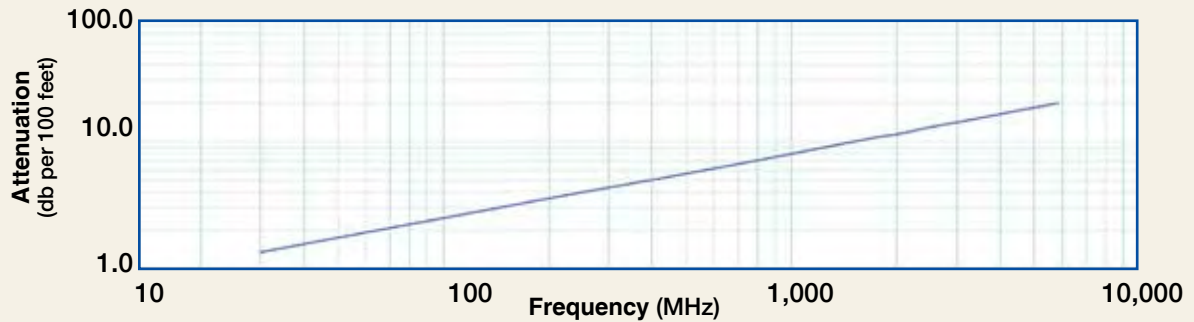

Frequency (MHz)	30	50	150	220	450	900	1500	1800	2000	2500	3400	5800
Attenuation dB/100 ft	1.8	2.3	4.1	4.9	7.1	10.0	13.0	14.3	15.1	16.9	19.8	26.1
Attenuation dB/100 m	5.9	7.7	13.3	16.1	23.2	32.9	42.7	46.9	49.5	55.5	65.0	85.7
Avg. Power kW	1.71	1.32	0.76	0.62	0.43	0.30	0.23	0.21	0.20	0.18	0.15	0.11

Calculate Attenuation =  $(0.329075) \cdot \sqrt{\text{FMHz}} + (0.000183) \cdot \text{FMHz}$  (interactive calculator available at [http://www.timesmicrowave.com/cable\\_calculators](http://www.timesmicrowave.com/cable_calculators))  
 Attenuation: VSWR=1.0; Ambient = +25°C (77°F) Power: VSWR=1.0; Ambient = +40°C; Inner Conductor = 100°C (212°F);  
 Sea Level; dry air; atmospheric pressure; no solar loading



**Connectors**

Interface	Description	Part Number	Stock Code	VSWR**	Coupling Nut	Inner Contact Attach	Outer Contact Attach	Finish* /Pin	Length in (mm)	Width in (mm)	Weight lb (g)
1. BNC Male	Straight Plug	TC-200-BM	3190-225	<1.25:1 (2.5)	Knurl	Solder	Crimp	S/G	1.7 (43.2)	0.56 (14.2)	0.045 (20.4)
2. Mini-UHF	Straight Plug	TC-200-MUHF	3190-444	<1.25:1 (2.5)	Knurl	Solder	Crimp	NG	1.1 (27.9)	0.45 (11.4)	0.015 (6.8)
3. N Male	Straight Plug	TC-200-NM	3190-224	<1.25:1 (2.5)	Knurl	Solder	Crimp	S/G	1.5 (38.1)	0.75 (19.1)	0.073 (33.1)
4. N Male	Reverse Polarity	TC-200-NM-RP	3190-959	<1.25:1 (2.5)	Knurl	Solder	Crimp	N/G	1.5 (38.0)	0.75 (19.1)	0.073 (33.1)
5. SM Male	Straight plug	TC-200-SM	3190-612	<1.25:1 (8)	Hex	Solder	Crimp	SS/G	1.0 (25.4)	0.32 (8.1)	0.015 (6.8)
6. SM Male	Reverse Polarity	TC-200-SM-RP	3190-327	<1.25:1 (2.5)	Hex	Solder	Crimp	SS/G	1.0 (25.4)	0.32 (8.1)	0.015 (6.8)
7. TNC Male	Straight Plug	TC-200-TMC	3190-240	<1.25:1 (2.5)	Knurl	Solder	Clamp	S/G	1.7 (43.2)	0.59 (15.0)	0.045 (20.4)
8. TNC Female	Straight Jack	TC-200-TF	3190-263	<1.25:1 (2.5)	NA	Solder	Crimp	N/G	1.3 (33.0)	0.57 (14.5)	0.033 (15.0)

\*Finish metals: N=Nickel, S=Silver, G=Gold, SS=Stainless Steel, A=Alballoy \*\*VSWR spec based on 3 foot cable with a connector pair

**Hardware Accessories**



Type	Part Number	Stock Code	Description
Ground Kit	GK-S200TT	GK-S200TT	Standard Ground Kit (each)

**Install Tools**

Type	Part Number	Stock Code	Description
Crimp Tool	CT-240/200/195/100	3190-667	Crimp tool for LMR-100, 195, 200 and 240 connectors
Deburr Tool	DBT-U	3192-001	Removes center conductor rough edges
Cutting Tool	CCT-02	3192-165	Cable end flush cut tool
Replacement Blade	RB-02	3192-166	Replacement blade for cutting tool





**Engineered Products:**

**FBT™-240**

**Flexible Low Loss High Power Communications Coax**

**Ideal for...**

- High Power Base Station Jumper Assemblies
- In-Building Plenum Feeder Runs
- Any High Power Low Loss RF cable application



Part Description					Stock
Part Number	Application	Jacket	Color	Code	
FBT-240	Indoor/Outdoor	FEP	Brown	54167	

Construction Specifications				
Description	Material	In.	(mm)	
Inner Conductor	Solid BC	0.051	(1.30)	
Dielectric	Low Density PTFE	0.150	(3.81)	
Outer Conductor	Aluminum Tape	0.155	(3.94)	
Overall Braid	Tinned Copper	0.178	(4.52)	
Jacket	Brown FEP	0.205	(5.21)	

Environmental Specifications			
Performance Property	°F	°C	
Installation Temperature Range	-67/+302	-55/+150	
Storage Temperature Range	-67/+302	-55/+150	
Operating Temperature Range	-67/+302	-55/+150	

Mechanical Specifications				
Performance Property	Units	US	(metric)	
Bend Radius: installation	in. (mm)	1.0	(25.4)	
Bend Radius: repeated	in. (mm)	2	(50.8)	
Bending Moment	ft-lb (N-m)	0.25	(0.34)	
Weight	lb/ft (kg/m)	0.040	(0.06)	
Tensile Strength	lb (kg)	60	(27.2)	
Flat Plate Crush	lb/in. (kg/mm)	85	(1.52)	

Electrical Specifications				
Performance Property	Units	US	(metric)	
Velocity of Propagation	%	76		
Dielectric Constant	NA	1.73		
Time Delay	nS/ft (nS/m)	1.34	(4.40)	
Impedance	ohms	50		
Capacitance	pF/ft (pF/m)	26.7	(87.6)	
Inductance	uH/ft (uH/m)	0.067	(0.22)	
Shielding Effectiveness	dB	>90		
DC Resistance				
Inner Conductor	ohms/1000ft (/km)	4.00	(13.1)	
Outer Conductor	ohms/1000ft (/km)	3.90	(12.8)	
Voltage Withstand	Volts DC	1500		
Jacket Spark	Volts RMS	5000		
Peak Power	kW	5.6		



Attenuation vs. Frequency (typical)

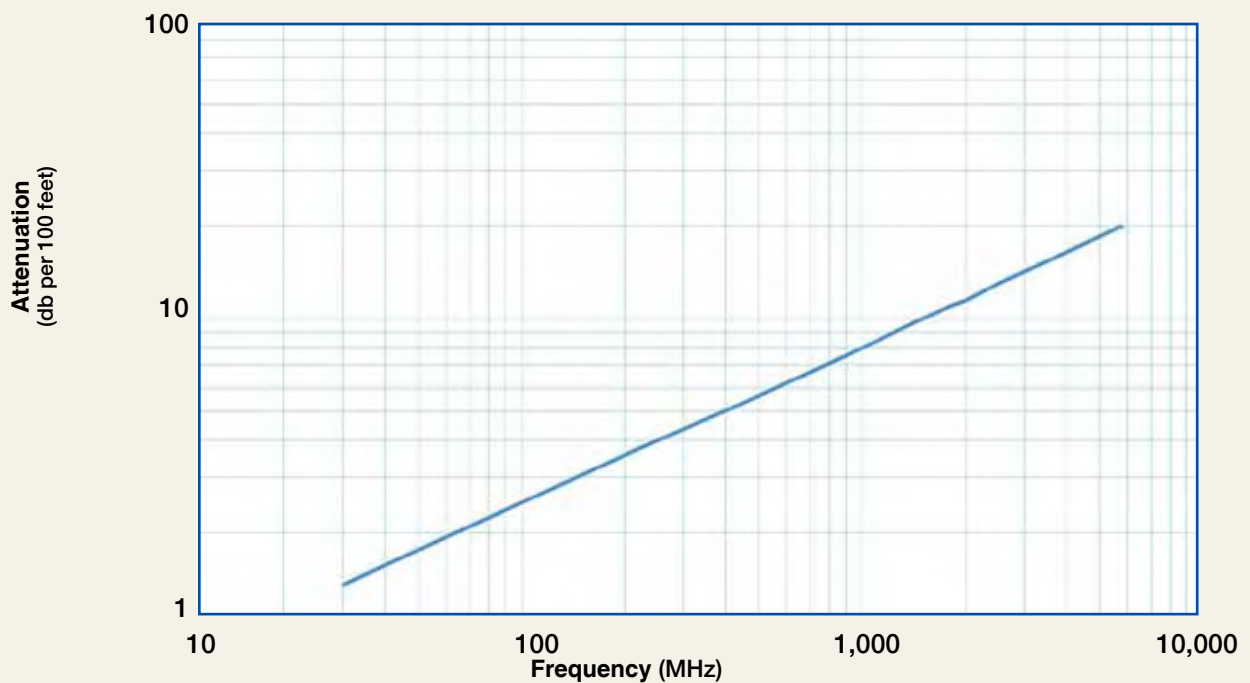

Frequency (MHz)	30	50	150	220	450	900	1500	1800	2000	2500	3400	5800
Attenuation dB/100 ft	1.4	1.8	3.1	3.7	5.4	7.6	9.9	10.9	11.5	12.9	15.1	20.0
Attenuation dB/100 m	4.5	5.8	10.1	12.2	17.6	25.0	33.2	35.7	37.7	42.3	49.6	65.6
Avg. Power kW	2.48	1.92	1.10	0.91	0.63	0.44	0.34	0.31	0.29	0.26	0.22	0.17

Calculate Attenuation =  $(0.248515) \cdot \sqrt{\text{FMHz}} + (0.000183) \cdot \text{FMHz}$  (interactive calculator available at [http://www.timesmicrowave.com/cable\\_calculators](http://www.timesmicrowave.com/cable_calculators))

**Attenuation:**

VSWR=1.0 ; Ambient = +25°C (77°F)

**Power:**

VSWR=1.0; Ambient = +40°C; Inner Conductor = 100°C (212°F); Sea Level; dry air; atmospheric pressure; no solar loading

**Engineered Products:**

**FBT-240**

**Flexible Low Loss High Power Communications Coax**



Connectors		Part Number	Stock Code	VSWR**	Coupling	Inner Contact Attach	Outer Contact Attach	Body Finish*	Length in (mm)	Width in (mm)	Weight lb (g)
1. BNC Male	Straight Plug	TC-240-BMC	3190-242	<1.25:1 (2.5)	Knurl	Solder	Clamp	S/G	1.7 (43)	0.56 (14.2)	0.040 (18.1)
2. Mini-UHF	Straight Plug	TC-240-MUHF	3190-445	<1.25:1 (2.5)	Knurl	Solder	Crimp	N/G	1.1 (28)	0.45 (11.4)	0.014 (6.4)
3. N Female	Bulkhead Jack	TC-240-NF-BH	3190-419	<1.25 (2.5)	NA	Solder	Crimp	A/G	1.7 (44)	0.88 (22.2)	0.115 (52.2)
4. N Male	Straight Plug	TC-240-NMH	3190-382	<1.25:1 (2.5)	Hex	Solder	Crimp	N/S	1.5 (38)	0.75 (19.1)	0.086 (39.0)
5. N Male	Straight Plug	TC-240-NMC	3190-244	<1.25:1 (2.5)	Knurl	Solder	Clamp	S/G	1.5 (38)	0.75 (19.1)	0.082 (37.2)
6. SMA Female	Bulkhead Jack	TC-240-SF-BH	3190-824	<1.25:1 (2.5)	NA	Solder	Crimp	SS/G	1.1 (29)	0.31 (7.9)	0.019 (8.6)
7. SMA Male	Straight Plug	TC-240-SM-SS-X	3190-2898	<1.25:1 (10)	Hex	Solder	Crimp	SS/G	1.0 (25)	0.32 (8.1)	0.016 (7.3)
8. SMA Male	Right Angle	TC-240-SM-RA	3190-381	<1.35:1 (6)	Hex	Solder	Crimp	SS/G	0.8 (20)	0.65 (16.5)	0.019 (8.6)
9. SMA Male	Reverse Polarity	TC-240-SM-RP	3190-326	<1.25:1 (2.5)	Hex	Solder	Crimp	SS/G	1.0 (25)	0.32 (8.1)	0.016 (7.3)
10. TNC Male	Straight Plug	TC-240-TM	3190-275	<1.25:1 (2.5)	Knurl	Solder	Crimp	N/S	1.7 (43)	0.59 (15.0)	0.043 (19.5)
11. TNC Male	Right Angle	TC-240-TM-RA	3190-604	<1.35:1 (2.5)	Knurl	Solder	Crimp	N/G	1.3 (33)	0.57 (14.5)	0.055 (24.9)
12. Type F Male	Straight Plug	TC-240-FM-X	3190-2891	<.25:1 (2.5)	Knurl	Solder	Crimp	N/G	1.1 (28)	0.45 (11.4)	0.014 (6.4)



## Hardware Accessories

Type	Part Number	Stock Code	Description
Ground Kit	GK-S240TT	GK-S240TT	Standard Ground Kit (each)



Type	Part Number	Stock Code	Description
Crimp Tool	CT-240/200/195/100	3190-667	Crimp tool for LMR-100, 195, 200 and 240 connectors
Deburr Tool	DBT-U	3192-001	Removes center conductor rough edges
Cutting Tool	CCT-02	3192-165	Cable and flush cut tool
Replacement Blade	RB-02	3192-166	Replacement blade for cutting tool

**Engineered Products:**

**FBT-300**

**Flexible Low Loss High Power Communications Coax**

**Ideal for...**

- High Power Base Station Jumper Assemblies
- In-Building Plenum Feeder Runs
- Any High Power Low Loss RF cable application



Part Description				Stock
Part Number	Application	Jacket	Color	Code
FBT-300	Indoor/Outdoor	FEP	Brown	54168

Environmental Specifications			
Performance Property	°F	°C	
Installation Temperature Range	-67/+302	-55/+150	
Storage Temperature Range	-67/+302	-55/+150	
Operating Temperature Range	-67/+302	-55/+150	

Construction Specifications			
Description	Material	In.	(mm)
Inner Conductor	Solid BC	0.063	(1.60)
Dielectric	Low Density PTFE	0.190	(4.83)
Outer Conductor	Aluminum Tape	0.196	(4.98)
Overall Braid	Tinned Copper	0.225	(5.72)
Jacket	Brown FEP	0.260	(6.60)

Mechanical Specifications			
Performance Property	Units	US	(metric)
Bend Radius: installation	in. (mm)	1.3	(31.8)
Bend Radius: repeated	in. (mm)	3	(76.2)
Bending Moment	ft-lb (N-m)	0.38	(0.52)
Weight	lb/ft (kg/m)	0.065	(0.10)
Tensile Strength	lb (kg)	120	(54.52)
Flat Plate Crush	lb/in. (kg/mm)	30	(0.54)

Electrical Specifications			
Performance Property	Units	US	(metric)
Velocity of Propagation	%	76	
Dielectric Constant	NA	1.73	
Time Delay	nS/ft (nS/m)	1.34	(4.40)
Impedance	ohms	50	
Capacitance	pF/ft (pF/m)	26.7	(87.6)
Inductance	uH/ft (uH/m)	0.067	(0.22)
Shielding Effectiveness	dB	>90	
DC Resistance			
Inner Conductor	ohms/1000ft (/km)	2.61	(8.6)
Outer Conductor	ohms/1000ft (/km)	2.21	(7.3)
Voltage Withstand	Volts DC	2000	
Jacket Spark	Volts RMS	5000	
Peak Power	kW	10	

Attenuation vs. Frequency (typical)

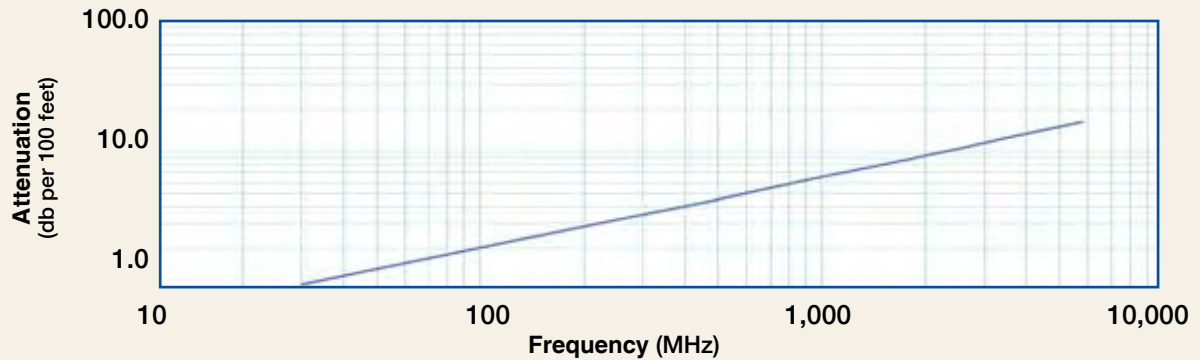

Frequency (MHz)	30	50	150	220	450	900	1500	1800	2000	2500	3400	5800
Attenuation dB/100 ft	1.1	1.4	2.5	3.0	4.3	6.2	8.0	8.8	9.3	10.5	12.3	16.3
Attenuation dB/100 m	3.6	4.7	8.1	9.9	14.2	20.2	26.3	28.9	30.6	34.3	40.3	53.5
Avg. Power kW	3.44	2.67	1.53	1.26	0.87	0.61	0.47	0.43	0.40	0.36	0.30	0.23

Calculate Attenuation =  $(0.200179) \cdot \sqrt{\text{FMHz}} + (0.000183) \cdot \text{FMHz}$  (interactive calculator available at [http://www.timesmicrowave.com/cable\\_calculators](http://www.timesmicrowave.com/cable_calculators))  
 Attenuation: VSWR=1.0 ; Ambient = +25°C (77°F) Power: VSWR=1.0; Ambient = +40°C; Inner Conductor = 100°C (212°F);  
 Sea Level; dry air; atmospheric pressure; no solar loading



**Connectors**

Interface	Description	Part Number	Stock Code	VSWR** Freq. (GHz)	Coupling Nut	Inner Contact Attach	Outer Contact Attach	Finish* Body /Pin	Length in (mm)	Width in (mm)	Weight lb (g)
1. SMA Male	Straight Plug	TC-300-SM	3190-501	<1.25:1 (2.5)	Hex	Solder	Crimp	SS/G	1.0 (25)	0.35 (8.9)	0.018 (8.2)
2. SMA Female	Bulkhead Jack	TC-300-SF-BH	3190-590	<1.25:1 (2.5)	NA	Solder	Crimp	SS/G	1.1 (28)	0.31 (7.9)	0.022 (10.0)
3. TNC Male	Straight Plug	TC-300-TM	3190-500	<1.25:1 (2.5)	Knurl	Solder	Crimp	N/S	1.7 (43)	0.59 (15.0)	0.050 (22.7)

\* Finish metals: N=Nickel, S=Silver, G=Gold, SS=Stainless Steel, A=Alloy \*\*VSWR spec based on 3 foot cable with a connector pair



**Hardware Accessories**

Type	Part Number	Stock Code	Description
Ground Kit	GK-S300TT	GK-S300TT	Standard Ground Kit (each)



**Install Tools**

Type	Part Number	Stock Code	Description
Crimp Tool	CT-400/300	3190-666	Crimp tool for LMR 300 connectors
Deburr Tool	DBT-U	3192-001	Removes center conductor rough edges
Cutting Tool	CCT-02	3192-165	Cable end flush cut tool
Replacement Blade	RB-02	3192-166	Replacement blade for cutting tool



**Engineered Products:**

**FBT™-400**

**Flexible Low Loss High Power Communications Coax**

**Ideal for...**

- High Power Base Station Jumper Assemblies
- In-Building Plenum Feeder Runs
- Any High Power Low Loss RF cable application



Part Description				Stock
Part Number	Application	Jacket	Color	Code
FBT-400	Indoor/Outdoor	FEP	Brown	54171

Environmental Specifications		
Performance Property	°F	°C
Installation Temperature Range	-67/+302	-55/+150
Storage Temperature Range	-67/+302	-55/+150
Operating Temperature Range	-67/+302	-55/+150

Construction Specifications			
Description	Material	In.	(mm)
Inner Conductor	Solid BCCAI	0.095	(2.41)
Dielectric	Low Density PTFE	0.285	(7.24)
Outer Conductor	Aluminum Tape	0.291	(7.39)
Overall Braid	Tinned Copper	0.320	(8.13)
Jacket	Brown FEP	0.370	(9.40)

Mechanical Specifications			
Performance Property	Units	US	(metric)
Bend Radius: installation	in. (mm)	1.8	(44.5)
Bend Radius: repeated	in. (mm)	4	(101.6)
Bending Moment	ft-lb (N-m)	1	(1.36)
Weight	lb/ft (kg/m)	0.104	(0.15)
Tensile Strength	lb (kg)	120	(54.5)
Flat Plate Crush	lb/in. (kg/mm)	185	(3.31)

Electrical Specifications			
Performance Property	Units	US	(metric)
Velocity of Propagation	%	76	
Dielectric Constant	NA	1.73	
Time Delay	nS/ft (nS/m)	1.34	(4.40)
Impedance	ohms	50	
Capacitance	pF/ft (pF/m)	26.7	(87.6)
Inductance	uH/ft (uH/m)	0.067	(0.22)
Shielding Effectiveness	dB	>90	
DC Resistance			
Inner Conductor	ohms/1000ft (/km)	1.80	(5.9)
Outer Conductor	ohms/1000ft (/km)	1.65	(5.4)
Voltage Withstand	Volts DC	2500	
Jacket Spark	Volts RMS	8000	
Peak Power	kW	16	

Attenuation vs. Frequency (typical)

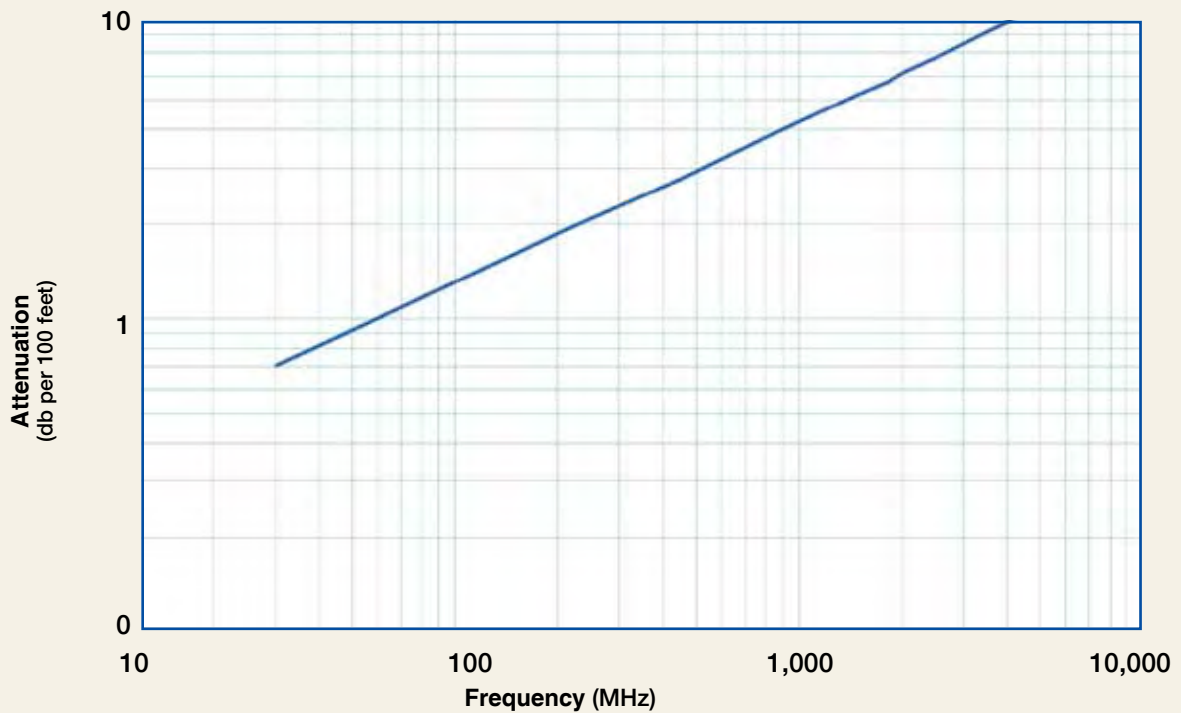

Frequency (MHz)	30	50	150	220	450	900	1500	1800	2000	2500	3400	5800
Attenuation dB/100 ft	0.7	0.9	1.6	1.9	2.8	4.0	5.2	5.7	6.1	6.8	8.0	10.7
Attenuation dB/100 m	2.3	3.0	5.3	6.4	9.2	13.1	17.1	18.8	19.9	22.4	26.3	35.0
Avg. Power kW	6.23	4.82	2.76	2.27	1.58	1.10	0.84	0.77	0.73	0.65	0.55	0.41

**Calculate Attenuation =**

$(0.129138) \cdot \sqrt{FMHz} + (0.000146) \cdot FMHz$  (interactive calculator available at [http://www.timesmicrowave.com/cable\\_calculators](http://www.timesmicrowave.com/cable_calculators))

**Attenuation:**

VSWR=1.0 ; Ambient = +25°C (77°F)

**Power:**

VSWR=1.0; Ambient = +40°C; Inner Conductor = 100°C (212°F); Sea Level; dry air; atmospheric pressure; no solar loading



**Engineered Products:**

**FBT-400**

**Flexible Low Loss High Power Communications Coax**



Connectors											
Interface	Description	Part Number	Stock Code	VSWR** Freq. (GHz)	Coupling Nut	Inner Contact Attach	Outer Contact Attach	Finish* Body /Pin	Length in (mm)	Width in (mm)	Weight lb (g)
1. N Female	Straight Jack	TC-400-NF-PL	3190-964	<1.25:1 (2.5)	NA	Solder	Crimp	N/G	1.8 (45)	0.66(16.8)	0.105 (47.6)
2. N Male	Straight Plug	EZ-400-NMH-PL-D	3190-602	<1.25:1 (2.5)	Hex/Knurl	Spring Finger	Crimp	A/G	1.5 (38)	0.89(22.6)	0.113 (51.3)
3. N Male	Straight Plug	TC-400-NMH-PL	3190-759	<1.25:1 (2.5)	Hex	Solder	Crimp	S/G	1.5 (38)	0.89(22.6)	0.113 (51.3)
4. N Male	Right Angle	TC-400-NMH-RA-D	3190-2293	<1.35:1 (6)	Hex/Knurl	Solder	Crimp	A/G	1.8 (46)	1.25(31.8)	0.130 (59.0)



**Hardware Accessories**

Type	Part Number	Stock Code	Description
Ground Kit	GK-S400T	GK-S400T	Standard Grounding Kit (each)



## Install Tools

Type	Part Number	Stock Code	Description
Crimp Tool	CT-U	3192-181	Crimp Handle (Dies Required)
Crimp Dies	Y1719	3190-202	.429" Hex Dies
Crimp Tool	CT-400/300	3190-666	Crimp tool for LMR 400 connectors
Crimp Rings	CR-400	3190-830	Crimp rings for TC/EZ-400 connectors (package of 10)
Deburr Tool	DBT-U	3192-001	For 'EZ' Style Connectors
Cutting Tool	CCT-02	3192-165	Cable and flush cut tool
Replacement Blade	RB-02	3192-166	Replacement blade for cutting tool

**Engineered Products:**

# FBT™-500 Flexible Low Loss High Power Communication

Ideal for...

- High Power Base Station Jumper Assemblies
- In-Building Plenum Feeder Runs
- Any High Power Low Loss RF cable application



Part Description				Stock
Part Number	Application	Jacket	Color	Code
FBT-500	Indoor/Outdoor	FEP	Brown	54172

Environmental Specifications		
Performance Property	°F	°C
Installation Temperature Range	-67/+302	-55/+150
Storage Temperature Range	-67/+302	-55/+150
Operating Temperature Range	-67/+302	-55/+150

Construction Specifications			
Description	Material	In.	(mm)
Inner Conductor	Solid BCCA1	0.123	(3.12)
Dielectric	Low Density PTFE	0.370	(9.40)
Outer Conductor	Aluminum Tape	0.376	(9.55)
Overall Braid	Tinned Copper	0.405	(10.29)
Jacket	Brown FEP	0.465	(11.81)

Mechanical Specifications			
Performance Property	Units	US	metric
Bend Radius: installation	in. (mm)	2.3	(57.2)
Bend Radius: repeated	in. (mm)	5	(127.0)
Bending Moment	ft-lb (N-m)	1.75	(2.37)
Weight	lb/ft (kg/m)	0.168	(0.25)
Tensile Strength	lb (kg)	120	(54.5)
Flat Plate Crush	lb/in. (kg/mm)	185	(3.31)

Electrical Specifications			
Performance Property	Units	US	(metric)
Velocity of Propagation	%	76	
Dielectric Constant	NA	1.73	
Time Delay	nS/ft (nS/m)	1.34	(4.40)
Impedance	ohms	50	
Capacitance	pF/ft (pF/m)	26.7	(87.6)
Inductance	uH/ft (uH/m)	0.067	(0.22)
Shielding Effectiveness	dB	>90	
DC Resistance			
Inner Conductor	ohms/1000ft (/km)	1.09	(3.6)
Outer Conductor	ohms/1000ft (/km)	1.27	(4.2)
Voltage Withstand	Volts DC	3000	
Jacket Spark	Volts RMS	8000	
Peak Power	kW	11.6	

Attenuation vs. Frequency (typical)

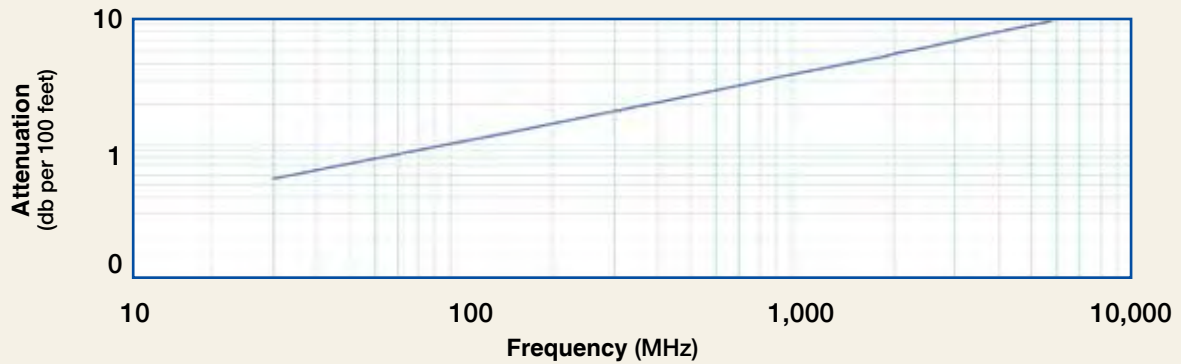

Frequency (MHz)	30	50	150	220	450	900	1500	1800	2000	2500	3400	5800
Attenuation dB/100 ft	0.6	0.7	1.3	1.5	2.2	3.1	4.1	4.5	4.8	5.4	6.4	8.5
Attenuation dB/100 m	1.8	2.3	4.1	5.0	7.2	10.3	13.5	14.8	15.7	17.6	20.9	27.9
Avg. Power kW	8.90	6.88	3.94	3.24	2.24	1.56	1.20	1.08	1.03	0.91	0.77	0.57

Calculate Attenuation =  $(0.100255) \cdot \sqrt{\text{FMHz}} + (0.000146) \cdot \text{FMHz}$  (interactive calculator available at [http://www.timesmicrowave.com/cable\\_calculators](http://www.timesmicrowave.com/cable_calculators))  
 Attenuation: VSWR=1.0; Ambient = +25°C (77°F) Power: VSWR=1.0; Ambient = +40°C; Inner Conductor = 100°C (212°F);  
 Sea Level; dry air; atmospheric pressure; no solar loading



**Connectors**

Interface	Description	Part Number	Stock Code	VSWR** Freq. (GHz)	Coupling Nut	Inner Contact Attach	Outer Contact Attach	Finish* Body /Pin	Length in (mm)	Width in (mm)	Weight lb (g)
N Male	Straight Plug	TC-500-NMC-PL	3190-900	<1.25:1 (2.5)	Hex	Solder	Clamp	S/G	2.1 (53)	0.92 (23.4)	0.228 (103.4)

\* Finish metals: N=Nickel, S=Silver, G=Gold, SS=Stainless Steel, A=Alballoy \*\*VSWR spec based on 3 foot cable with a connector pair



**Install Tools**

Type	Part Number	Stock Code	Description
Crimp Tool	CT-U	3192-181	Crimp handle (Dies Required)
Crimp Tool	CT-500	3192-169	Crimp tool for LMR-500 connectors
Crimp Dies	Y151	3190-465	.532" Hex Dies
Deburr Tool	DBT-U	3192-001	Removes center conductor rough edges
Cutting Tool	CCT-02	3192-165	Cable end flush cut tool
Replacement Blade	RB-02	3192-166	Replacement blade for cutting tool



**Engineered Products:**

**FBT™-600**

**Flexible Low Loss High Power Communications**

**Ideal for...**

- High Power Base Station Jumper Assemblies
- In-Building Plenum Feeder Runs
- Any High Power Low Loss RF cable application

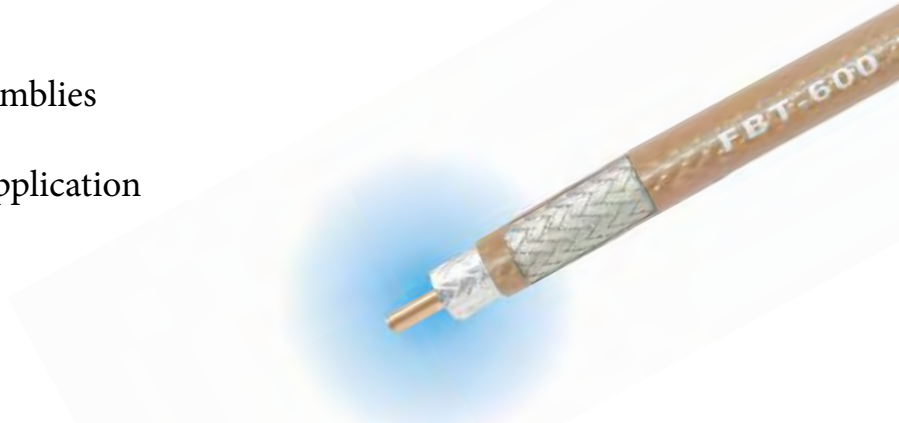

Part Description				Stock
Part Number	Application	Jacket	Color	Code
FBT-600	Indoor/Outdoor	FEP	Brown	54173

Environmental Specifications		
Performance Property	°F	°C
Installation Temperature Range	-67/+302	-55/+150
Storage Temperature Range	-67/+302	-55/+150
Operating Temperature Range	-67/+302	-55/+150

Construction Specifications			
Description	Material	In.	(mm)
Inner Conductor	Solid BCCAI	0.150	(3.81)
Dielectric	Low Density PTFE	0.455	(11.56)
Outer Conductor	Aluminum Tape	0.461	(11.71)
Overall Braid	Tinned Copper	0.490	(12.45)
Jacket	Brown FEP	0.565	(14.38)

Mechanical Specifications			
Performance Property	Units	US	(metric)
Bend Radius: installation	in. (mm)	2.8	(69.9)
Bend Radius: repeated	in. (mm)	6	(152.4)
Bending Moment	ft-lb (N-m)	2.75	(3.73)
Weight	lb/ft (kg/m)	0.210	(0.31)
Tensile Strength	lb (kg)	265	(120.3)
Flat Plate Crush	lb/in. (kg/mm)	210	(3.75)

Electrical Specifications			
Performance Property	Units	US	(metric)
Velocity of Propagation	%	76	
Dielectric Constant	NA	1.73	
Time Delay	nS/ft (nS/m)	1.34	(4.40)
Impedance	ohms	50	
Capacitance	pF/ft (pF/m)	26.7	(87.6)
Inductance	uH/ft (uH/m)	0.067	(0.22)
Shielding Effectiveness	dB	>90	
DC Resistance			
Inner Conductor	ohms/1000ft (/km)	0.73	(2.4)
Outer Conductor	ohms/1000ft (/km)	1.20	(3.9)
Voltage Withstand	Volts DC	4000	
Jacket Spark	Volts RMS	8000	
Peak Power	kW	40	



Attenuation vs. Frequency (typical)

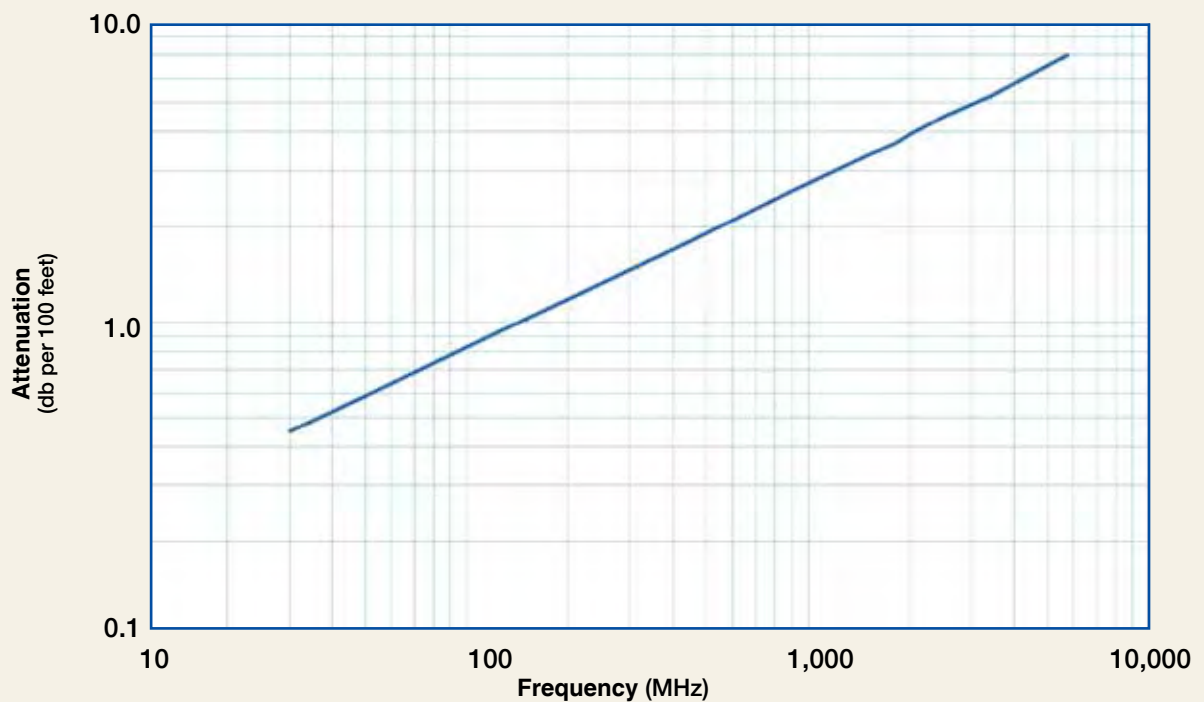

Frequency (MHz)	30	50	150	220	450	900	1500	1800	2000	2500	3400	5800
<b>Attenuation dB/100 ft</b>	0.5	0.6	1.0	1.2	1.8	2.6	3.4	3.7	3.9	4.4	5.3	7.1
<b>Attenuation dB/100 m</b>	1.5	1.9	3.3	4.1	5.9	8.4	11.1	12.2	12.9	14.5	17.2	23.2
<b>Avg. Power kW</b>	11.84	9.14	5.23	4.30	2.97	2.07	1.57	1.43	1.35	1.20	1.01	0.75

Calculate Attenuation =

$$(0.081389) \cdot \sqrt{\text{FMHz}} + (0.000146) \cdot \text{FMHz}$$

(interactive calculator available at [http://www.timesmicrowave.com/cable\\_calculators](http://www.timesmicrowave.com/cable_calculators))

**Attenuation:**

VSWR=1.0 ; Ambient = +25°C (77°F)

**Power:**

VSWR=1.0; Ambient = +40°C; Inner Conductor = 100°C (212°F); Sea Level; dry air; atmospheric pressure; no solar loading

**Engineered Products:**

**FBT-600**

**Flexible Low Loss High Power Communications Coax**



Connectors											
Interface	Description	Part Number	Stock Code	VSWR** Freq. (GHz)	Coupling Nut	Inner Contact Attach	Outer Contact Attach	Finish* Body /Pin	Length in (mm)	Width in (mm)	Weight lb (g)
1. LC Male	Straight plug	TC-600-LCM-PL	3190-1221	<1.25:1 (1)	Hex	Solder	Clamp	N/S	3.1 (78.7)	1.62 (41.1)	1.20 (544)
2. N Male	Straight Plug	EZ-600-NMH-PL-D	3190-603	<1.25:1 (2.5)	Hex/Knurl	Spring	Finger Crimp	A/G	2.1 (53)	0.92 (23.4)	0.166 (75.3)
3. N Male	Straight Plug	TC-600-NMH-PL	3190-760	<1.25:1 (2.5)	Hex	Solder	Crimp	S/G	2.1 (53)	0.92 (23.4)	0.208 (93.4)
4. N Male	Right Angle	TC-600-NMC-RA	3190-233	<1.35:1 (2.5)	Hex	Solder	Clamp	S/G	2.1 (53)	0.92 (23.4)	0.280 (17.9)
5. N Male	Right Angle	TC-600-NMH-RA-D	3190-2427	<1.35:1 (6)	Hex	Solder	Crimp	A/G	1.8 (46.5)	1.62 (41.2)	0.185 (84.3)



**Hardware Accessories**

Type	Part Number	Stock Code	Description
Ground Kit	GK-S600TT	GK-S600TT	Standard Grounding Kit (each)



## Install Tools

Type	Part Number	Stock Code	Description
Crimp Tool	CT-U	3192-181	Crimp handle (Dies Required)
Crimp Tool	CT-600	3192-170	Crimp tool for LMR-600 connectors
Crimp Dies	Y1720	3190-203	.610" hex dies
Crimp Rings	CR-600	3190-831	Crimp rings for TC/EZ-600 connectors (pkg of 10)
Deburr Tool	DBT-U	3192-001	Removes center conductor rough edges
Midspan Strip Tool	GST-600A	3190-1051	For ground strap attachment
Cutting Tool	CCT-02	3192-165	Cable end flush cut tool
Replacement Blade	RB-02	3192-166	Replacement blade for cutting tool



## Characteristics of Jumpers Defined by a Smart Part Number



### Performance:

Our LMR® and TCOM® jumper assemblies are optimized for electrical, mechanical and environmental performance. **Refer to our website at [www.timesmicrowave.com](http://www.timesmicrowave.com) for an interactive part number and pricing calculator.**

### Marking:

- Assemblies  $\leq$  to one meter in length are to have one centrally located marker.
- All other assemblies are to have identical markers placed 1-2" behind the strain relief boots on both ends of the assembly
- Markers are to be black text on white tubing
- Marker configuration to be:

**TIMES MICROWAVE SYSTEMS  
(SMART P/N)  
( serial number)**

### Electrical:

- Insertion Loss will not exceed (1.1 x published attenuation + 2 x 0.15dB)
- VSWR
  - Maximum of 1.25:1 to 2.5 GHz
  - Maximum of 1.35:1 to 6 GHz

Note: Above VSWR values apply to N's, TNC's mini DIN's, 7/16 DIN's SMA's QMA's and QN's

**Mechanical:** WSB boots will be used in place of ATUM shrink boots where applicable

### Test Data:

- Serialized data is logged and available upon request

### Packaging:

- Assemblies are supplied with dust caps

## Smart Part Number Key for LMR and TCOM Jumpers

(The finished part number should not contain dashes)

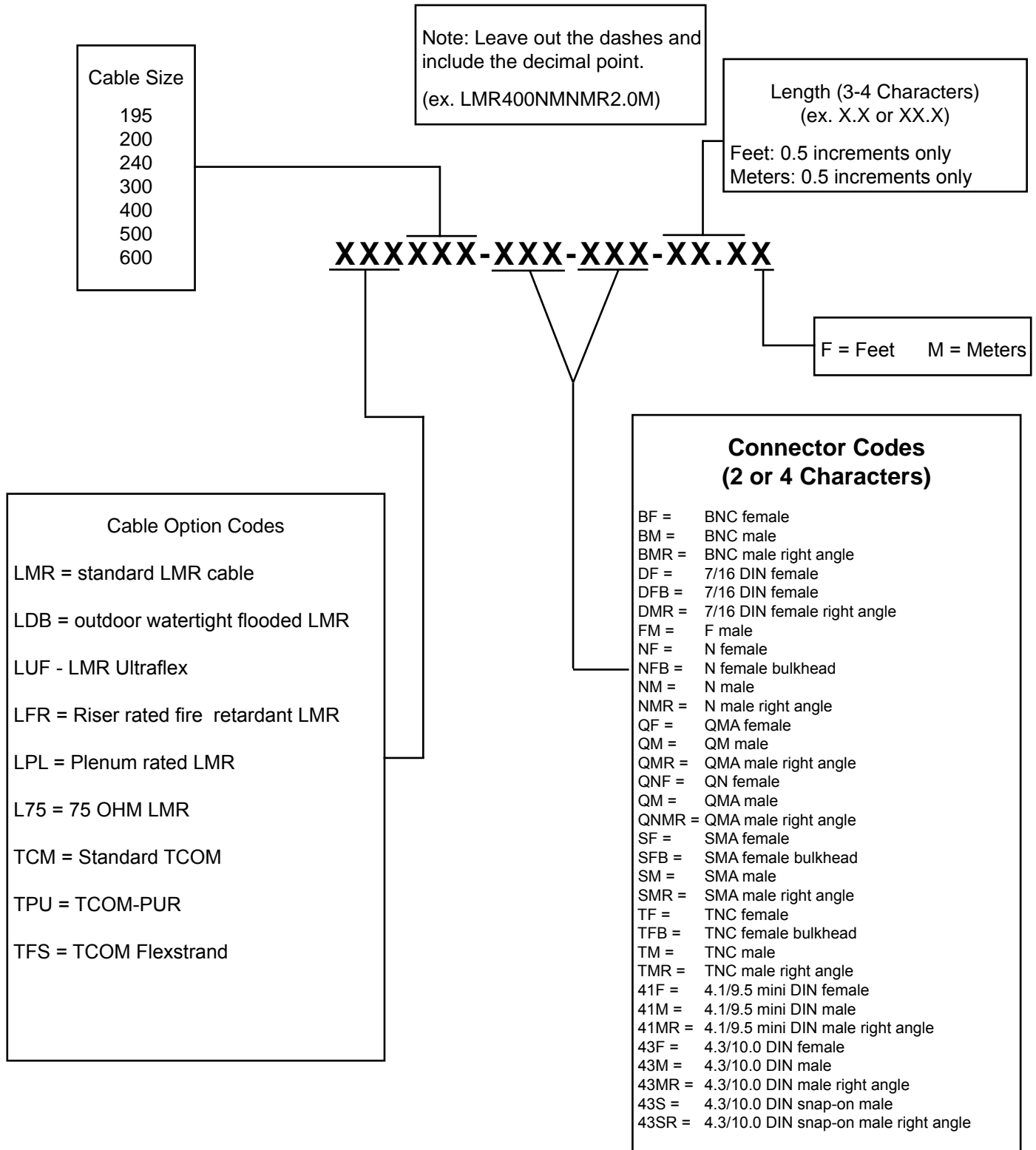

**Engineered Products:**

**T-RAD-600  
50 Ohm Leaky Feeder Coaxial Cable**

- Provides RF coverage in buildings, mines and other enclosed areas
- Offers broadband performance up to 2.5 GHz
- Flexible, non-kinking design provides easier installation
- Accepts standard "EZ" crimp connectors used for LMR-600 cable\*
- FR series is MSHA approved for mining applications



Part Number	Part Description Application	Jacket	Color	Stock Code
AA 9096	T-RAD-600-PVC	PVC	Black	44030
AA-9097	T-RAD-600-FR	FRPE	Black	44031

Construction Specifications			
Description	Material	In.	(mm)
Inner Conductor	Solid BCCA1	0.176	(4.47)
Dielectric	Gas-Injected Foam Polyethylene	0.455	(11.56)
Inner Shield	Bonded Aluminum Tape	0.458	(11.63)
Jacket	See table above	0.530	(13.46)

Mechanical Specifications			
Performance Property	Units	US	(metric)
Bend Radius: installation	in. (mm)	1.5	(38)
Bend Radius: repeated	in. (mm)	6.0	(152.4)
Weight	lb/ft (kg/m)	0.09	(0.137)

Environmental Specifications		
Performance Property	°F	°C
Operating Temperature Range	-40/+185	-40/+85

Electrical Specifications			
Performance Property	Units	US	(metric)
Velocity of Propagation	%	86	
Dielectric Constant	NA	1.35	
Time Delay	nS/ft (nS/m)	1.18	(3.87)
Impedance	ohms	50	
Voltage Withstand	Volts DC	4000	
Jacket Spark	Volts RMS	6000	

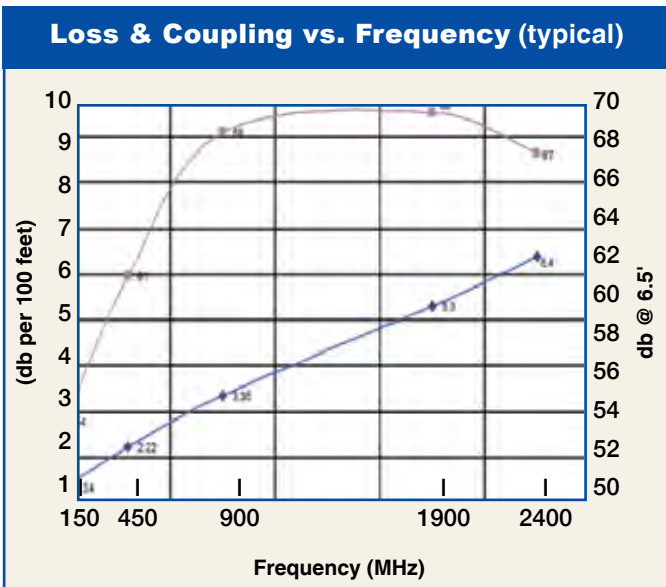

Frequency (MHz)	150	450	900	1900	2400
<b>Attenuation dB/100 ft</b>	1.34	2.22	3.35	5.30	6.40
<b>Attenuation dB/100 m</b>	4.39	7.28	10.98	17.38	20.99
<b>Coupling Loss** dB</b>	54	61	68	69	67

\* Request T-RAD-600 connector data sheet and attachment instructions  
 \*\* Coupling loss measured at 6.5 feet (2 meters) \*\*\* Patent applied for



Connectors											Length	Width	Weight
Interface	Description	Part Number	Stock Code	VSWR** Freq. (GHz)	Coupling Nut	Inner Contact Attach	Outer Contact Attach***	Finish* Body /Pin	in (mm)	in (mm)	lb	(g)	
1. 7-16DIN Male	Straight Plug	EZ-600-716-M-X	3190-2643	<1.25:1 (2.5)	Hex	Spring Finger	Crimp	S/S	2.0 (51)	1.30 (33.0)	0.254 (115.2)		
2. N Male	Straight Plug	EZ-600-NMH-X	3190-2627	<1.25:1 (2.5)	Hex/Knurl	Spring Finger	Crimp	A/G	2.1 (53)	0.92 (23.4)	1.164 (74.4)		
3. N Male	Right Angle	EZ-600-NMH-RA-X	3190-2639	<1.35:1 (6)	Hex	Spring Finger	Crimp	S/G	2.1 (53)	0.92 (23.4)	0.185 (83.9)		
4. N Female	Straight Jack	EZ-600-NF-X	3190-2817	<1.25:1 (2.5)	NA	Spring Finger	Crimp	S/G	2.3 (59)	0.87 (22.1)	0.150 (68.0)		
5. N Female	Bulkhead Jack	EZ-600-NF-BH	3190-616	<1.25:1 (2.5)	NA	Spring Finger	Crimp	S/G	2.4 (61)	0.88 (22.4)	0.195 (88.5)		
6. TNC Male	Straight Plug	EZ-600-TM-X	3190-2531	<1.25:1 (2.5)	Knurl	Spring Finger	Crimp	S/G	1.7 (43)	0.59 (15.0)	0.112 (50.8)		
7. TNC Male	Reverse Polarity	EZ-600-TM-RP	3190-796	<1.25:1 (2.5)	Knurl	Spring Finger	Crimp	A/G	2.2 (56)	0.87 (22.0)	0.112 (50.8)		
8. TNC Female	Reverse Polarity	EZ-600-TF-RP	3190-797	<1.25:1 (2.5)	NA	Spring Finger	Crimp	A/G	2.3 (58)	0.87 (22.0)	0.100 (45.4)		
9. UHF Male	Straight Plug	EZ-600-UM	3190-615	<1.25:1 (2.5)	Knurl	Spring Finger	Crimp	S/G	1.7 (43)	0.88 (22.4)	0.164 (74.4)		
10. Crimp Ring	Crimping	TR-600	3192-038	Package of 50 pieces									
11. Strip Tool	Combination prep tool for TRAD-600 3192-197												

\* Finish metals: N=Nickel, S=Silver, G=Gold, SS=Stainless Steel, A=Alballoy \*\*VSWR spec based on 3 foot cable with a connector pair

**Engineered Products:**

## T-RAD-600-DB 50 Ohm Leaky Feeder Coaxial Cable

- Provides RF coverage in buildings, mines and other enclosed areas
- Watertight design for direct bury applications
- Offers broadband performance up to 2.5 GHz
- Flexible, non-kinking design provides easier installation
- Accepts standard "EZ" crimp connectors used for LMR-600 cable\*

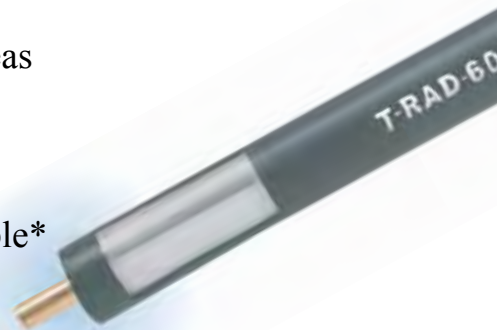

Part Description				Stock
Part No.	Application	Jacket	Color	Code
AA-9299	T-RAD-600-DB	PVC/PE	Black	44038

Construction Specifications			
Description	Material	In.	(mm)
Inner Conductor	Solid BCCAI	0.176	(4.47)
Dielectric	Gas-Injected Foam Polyethylene	0.455	(11.56)
Inner Shield	Bonded Aluminum Tape	0.458	(11.63)
Jacket	Extruded PVC/PE	0.590	(14.98)

Mechanical Specifications			
Performance Property	Units	US	(metric)
Bend Radius: installation	in. (mm)	1.5	(38)
Bend Radius: repeated	in. (mm)	0.12	(.178)
Weight	lb/ft (kg/m)	0.09	(0.137)

Environmental Specifications		
Performance Property	°F	°C
Operating Temperature Range	+23/+167	-5/+75

Electrical Specifications			
Performance Property	Units	US	(metric)
Velocity of Propagation	%	86	
Dielectric Constant	NA	1.35	
Time Delay	nS/ft (nS/m)	1.18	(3.87)
Impedance	ohms	50	
Voltage Withstand	Volts DC	4000	
Jacket Spark	Volts RMS	6000	

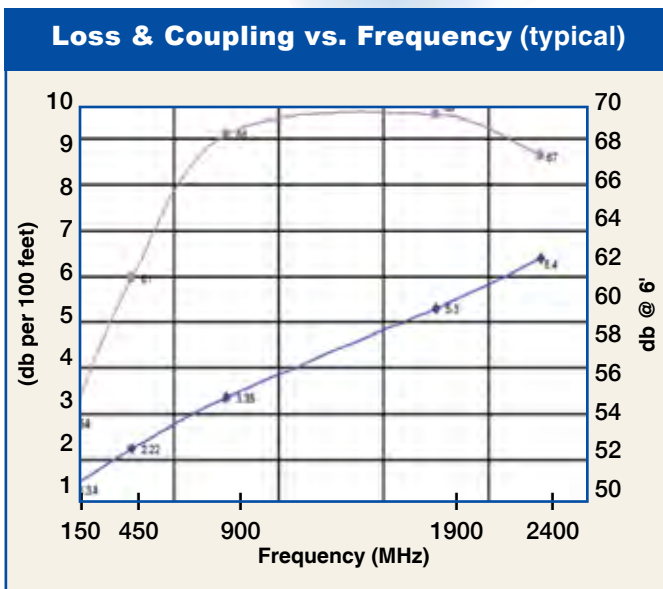

Frequency (MHz)	150	450	900	1900	2400
Attenuation dB/100 ft	1.34	2.22	3.35	5.30	6.40
Attenuation dB/100 m	4.39	7.28	10.98	17.38	20.99
Coupling Loss** dB	54	61	68	69	67

\* Request T-RAD-600 connector data sheet and attachment instructions  
 \*\* Coupling loss measured at 6.5 feet (2 meters) \*\*\* Patent applied for

Connectors											
Interface	Description	Part Number	Stock Code	VSWR** Freq. (GHz)	Coupling Nut	Inner Contact Attach	Outer Contact Attach***	Finish* Body /Pin	Length in (mm)	Width in (mm)	Weight lb (g)
1.	7-16 DIN Male Straight Plug	EZ-600-716-M-X	3190-2643	<1.25:1 (2.5)	Hex	Spring Finger	Crimp	A/S	1.8 (42)	1.38 (35.0)	0.209 (94.80)
2.	N Male Straight Plug	EZ-600-NMH-X	3190-2627	<1.25:1 (2.5)	Hex/Knurl	Spring Finger	Crimp	A/G	2.1 (53)	0.92 (23.4)	1.164 (74.4)
3.	N Male Right Angle	EZ-600-NMH-RA-X	3190-2639	<1.35:1 (6)	Hex	Spring Finger	Crimp	A/G	2.0 (50)	1.42 (36.0)	0.224 (101.7)
4.	N Female Straight Jack	EZ-600-NF-X	3190-2871	<1.30:1 (6)	NA	Spring Finger	Crimp	A/G	1.7 (43)	0.69 (17.6)	0.150 (68.0)
5.	N Female Bulkhead Jack	EZ-600-NF-BH	3190-616	<1.25:1 (2.5)	NA	Spring Finger	Crimp	S/G	2.4 (61)	0.88 (22.4)	0.090 (40.6)
6.	TNC Male Straight Plug	EZ-600-TM-X	3190-2531	<1.25:1 (6)	Hex/Knurl	Spring Finger	Crimp	A/G	2.3 (57.6)	0.75 (19.0)	0.100 (45.6)
7.	TNC Male Reverse Polarity	EZ-600-TM-RP	3190-796	<1.25:1 (2.5)	Knurl	Spring Finger	Crimp	A/G	2.2 (56)	0.87 (22.0)	0.112 (50.8)
8.	TNC Female Reverse Polarity	EZ-600-TF-RP	3190-797	<1.25:1 (2.5)	NA	Spring Finger	Crimp	A/G	2.3 (58)	0.87 (22.0)	0.100 (45.4)
9.	UHF Male Straight Plug	EZ-600-UM	3190-615	<1.25:1 (2.5)	Knurl	Spring Finger	Crimp	S/G	1.7 (43)	0.88 (22.4)	0.164 (74.4)

\* Finish metals: N=Nickel, S=Silver, G=Gold, SS=Stainless Steel, A=Alloy \*\*\* Requires separate crimp ring; contact TMS engineering

## T-RAD Connector installation procedure

LMR-600 crimp connectors can be used on T-RAD-600 cables with special TR-600 crimp rings (stock code 3192-038).

NOTE: TR-600 crimp rings must be purchased separately

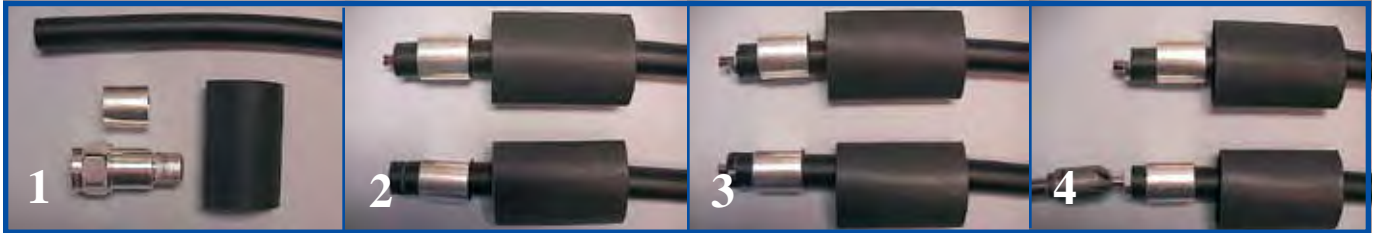

**Step 1:** Flush cut the cable squarely

**Step 2:** Slide the heat shrink and TR-600 crimp ring over the cable. Use a knife or razor to cut a 0.250" long ring from the end of the cable. Make sure that the cut is square.

**Step 3:** Lightly score the circumference of the cable 0.20" back from the end of the core. Make one long longitudinal cut. Pry up a piece of the jacket and gently peel the ring of the jacket off the core.

**Step 4:** Debur the center conductor using the DBT 01 deburring tool



**Step 5:** Slide the connector over the end of the core and push it up to the end of the jacket. Rotate the connection back and forth in a clockwise-counter clockwise motion in reference to the axis of the cable until the back of the connector works its way under the end of the jacket. Now push the connector onto the cable with some back and forth motion until it stops.

NOTE: A small longitudinal cut of 1/4" may be made to the outer jacket to assist with the connector body sliding under the outer jacket.

**Step 6:** Position the heavy duty HX-4 crimp tool, with the appropriate dies (stock code 3190-203), directly behind and adjacent to the connector body, and crimp the connector. The crimp tool automatically releases when the crimp is complete

**Step 7:** Position the heat shrink boot as far forward on the connector body as possible without interfering with the coupling nut; use a heat gun to form a weather-tight seal.



*Special Crimp Ring  
part number 3192-038  
(TR-600) must be used on  
all EZ style connectors*

## T-RAD-900 50 Ohm Leaky Feeder Coaxial Cable

- Provides RF coverage in buildings, mines and other enclosed areas
- Offers broadband performance up to 2.5 GHz
- Flexible, non-kinking design provides easier installation
- Accepts standard "EZ" clamp connectors used for LMR-900 cable\*
- FR series is MSHA approved for mining applications

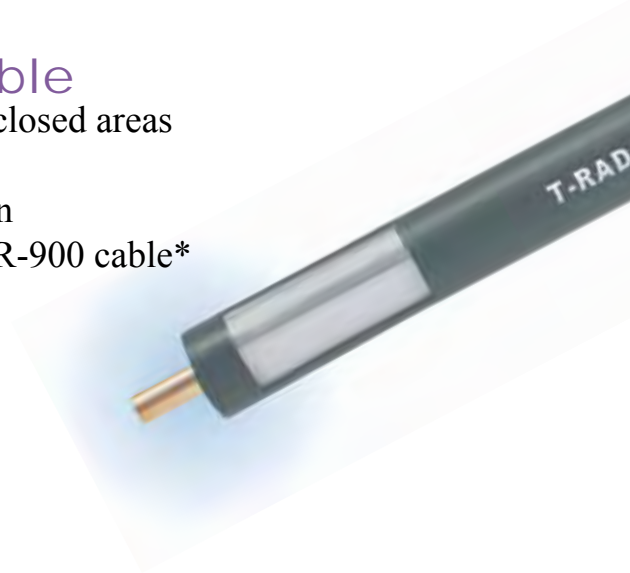

Part Description				Stock
Part No.	Application	Jacket	Color	Code
AA-9298	T-RAD-900-PVC	PVC	Black	44042
AA-9630	T-RAD-900-FR	FRPE	Black	44046

Construction Specifications			
Description	Material	In.	(mm)
Inner Conductor	BC Tube	0.262	(6.65)
Dielectric	Gas-Injected Foam Polyethylene	0.680	(17.27)
Inner Shield	Bonded Aluminum Tape	0.686	(17.42)
Jacket	see table above	0.870	(22.10)

Mechanical Specifications			
Performance Property	Units	US	(metric)
Bend Radius: installation	in. (mm)	3.00	(76.2)
Bend Radius: repeated	in. (mm)	9.0	(228.6)
Weight	lb/ft (kg/m)	0.266	(0.40)

Environmental Specifications		
Performance Property	°F	°C
Operating Temperature Range	-40/+185	-40/+85

Electrical Specifications			
Performance Property	Units	US	(metric)
Velocity of Propagation	%	87	
Dielectric Constant	NA	1.32	
Time Delay	nS/ft (nS/m)	1.17	(3.83)
Impedance	ohms	50	
Voltage Withstand	Volts DC	5000	
Jacket Spark	Volts RMS	8000	

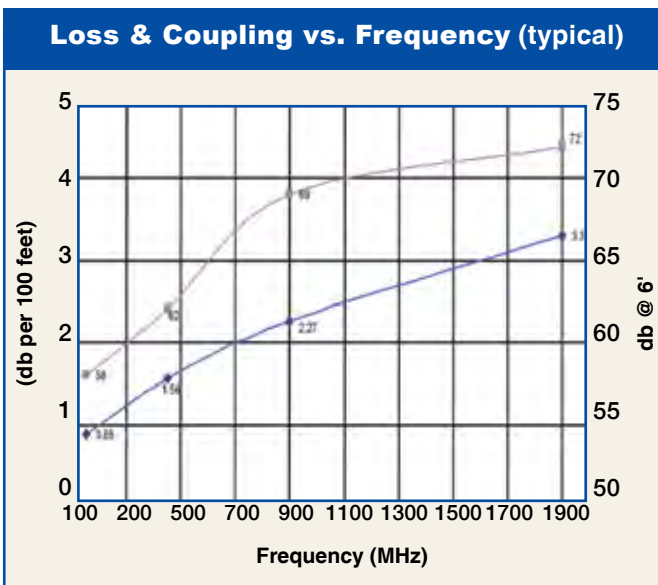

Frequency (MHz)	150	450	900	1900
Attenuation dB/100 ft	0.88	1.56	2.27	3.3
Attenuation dB/100 m	2.89	5.12	7.44	10.8
Coupling Loss** dB	58	62	69	72

\* Request T-RAD-900 connector data sheet and attachment instructions  
 \*\* Coupling loss measured at 6.5 feet (2 meters) \*\*\* Patent applied for

-900-PVC TIMES MICROWAVE



Connectors												
Interface	Description	Part Number	Stock Code	VSWR** Freq. (GHz)	Coupling Nut	Inner Contact Attach	Outer Contact Attach	Finish* Body /Pin	Length in (mm)	Width in (mm)	Weight lb (g)	
1. 7-16 DIN Female	Straight Jack	EZ-900-716FC	3190-334	<1.25:1 (2.5)	NA	Press Fit	Clamp	S/S	2.0 (51)	1.38 (35.1)	0.379 (171.9)	
2. 7-16 DIN Male	Straight Plug	EZ-900-716MC-2	3190-1641	<1.25:1 (2.5)	Hex	Press Fit	Clamp	S/S	2.0 (51)	1.44 (36.6)	0.485 (220.0)	
3. 7-16 DIN Male	Right Angle	EZ-900-716-MC-RA	3190-614	<1.35:1 (2.5)	Hex	Press Fit	Clamp	S/S	2.7 (69)	2.15 (55.0)	1.150 (521.6)	
4. 7/8 EIA	Straight Plug	EZ-900-78EIA-2	3190-1282	<1.25:1 (2.5)	NA	Press Fit	Clamp	S/S	3.0 (76)	2.24 (56.9)	1.013 (459.5)	
5. N Male	Straight Plug	EZ-900-NMC-2	3190-1262	<1.25:1 (6)	Hex	Press Fit	Clamp	S/S	2.0 (51)	1.38 (35.1)	0.463 (210.0)	
6. N Female	Straight Jack	EZ-900-NFC-2	3190-1263	<1.25:1 (6)	NA	Press Fit	Clamp	S/S	2.0 (51)	1.38 (35.1)	0.443 (200.9)	

\* Finish metals: N=Nickel, S=Silver, G=Gold, SS=Stainless Steel, A=Alballoy \*\*VSWR spec based on 3 foot cable with a connector pair  
NOTE: Clamp drain wire for connector attachment. A heavy duty adhesive lined shrink boot is recommended to attach over the connector body and cable jacket



**Engineered Products:**

# SilverLine®

## Test Cables

*ISO 9001 Certified*

### Coax Test Cables for:

- High Volume Production Test Stations
- Research & Development Labs
- Environmental & Temperature Test Chambers
- Replacement for OEM Test Port Cables
- Field RF Testing
- Cellular Infrastructure Site Testing



SilverLine® Test Cables are cost effective, durable, high-performance cable assemblies designed for use in a broad range of test and interconnect applications. Fabricated from rugged, solid PTFE dielectric cable with stainless steel connectors and a proven strain relief system, these cables provide long life and excellent stability in applications where they are repeatedly flexed and mated/unmated. SilverLine® test cables are ideal for use in production, field and laboratory test environments. They are also economical enough to be used as interconnects in test systems.

#### Features & Benefits:

- Phase & Loss Stable
- Long Flex Life
- Triple Shielded Cable
- High Mating Cycle, Stainless Steel Connectors
- Rugged, Solder-Clamp Attachment
- Redundant, Long Life Strain Relief System
- ROHS Compliant

#### Time's Silverline® Product Guarantee

*Times will repair or replace your SilverLine test cable at its option if the connector attachment fails within four months of shipment. This guarantee excludes cable or connector interface damage from misuse or abuse.*

## Engineered Products:

# SilverLine®

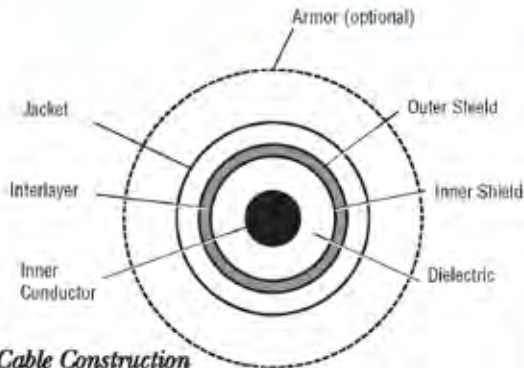

### Cable Construction

**Inner Conductor:** Solid silver plated copper clad steel

**Dielectric:** Solid PTFE

**Shield:** Silver plated copper flat ribbon braid aluminum-polyimide tape interlayer 36 GA silver plated copper braid (90%k)

**Jacket:** Clear FEP

**Armor (Optional):**

**PVC Style:** Steel wire reinforced, thick wall, high flex life clear PVC

**Steel Style:** 100% coverage, square locked, galvanized steel hose, high angle steel braid and TPR jacket

### Connectors

- Passivated stainless steel finish (QMA coupling nut is nickel plated brass)
- QMA SureGrip™ coupling nut design
- Captive contact
- Thick wall interface (SMA)
- Gold plated beryllium copper center contacts
- PTFE dielectric
- Type N & SMA OneTurn™ (1 full rotation to mate)
- High temperature 7mm
- Knurl/hex coupling nut (Type N and TNC)
- Precision grade 7-16

### Connector Attachment/Strain Relief

- Rugged, solder-clamp to braid. 175-300 lb pull force. Additional crimp system on armored version.
- Redundant triple layer strain relief system (Dual layer on armored version)

Physical & Mechanical Specifications		
Dimensions	in	mm
Inner Conductor	0.037	0.94
Dielectric	0.116	2.95
Inner Shield	0.126	3.20
Interlayer	0.132	3.35
Outer Shield	0.154	3.91
Jacket	0.195	4.95
Armor (optional)	0.450	11.50
Weight lbs./ft (kg/m)	Cable: 0.043 (0.064)    Armor: 0.066 (0.098)	
Armor Crush Resistance	PVC: 1200 lbs. per linear inch - Steel: 1500 lbs. per linear inch	
Bend Radius: minimum	1	25
Connector Retention	Unarmored & Armored PVC > 175 lbs. - Steel Armored > 300 lbs.	
Mating Life Cycle	QMA, SMA, Type N: > 5000*	
Length Tolerances	± 2 ft. or 0.75m, 0, +0.50" (12.7mm) > 2 ft. or 0.75m, 0, ±2% of length	
Temperature Range	-67°/+221°F	-55°/+105°C

Electrical Specifications					
VSWR Max		4 GHz	6 GHz	18 GHz	26.5 GHz
	BNC	1.20:1			
	7-16 DIN		1.25:1		
	SMA, QMA, 9.5mm, Type N, TNC, Swept RA		1.20:1	1.30:1	1.35:1
	7mm		1.25:1	1.35:1	

Impedance	50 ohms
Velocity of Propagation	70 %
Shielding Effectiveness	>100 dB
Capacitance	29.4 pF/ft = 96.4 pF/meter
Phase Stability	±/2° through 18 GHz (50,000 cycles)***
	±/ 3° through 26.5 GHz

Attenuation Max @ +77°F (+25°C)			
Attenuation (GHz)		dB/100 ft	dB/100 m
1		12	40
2		18	59
6		34	112
12		53	174
18		68	224
26.5		89	290

Attenuation at any frequency formula <sup>†</sup>		
R1	(K1 + √F(MHz)) + (K2 * F(MHz))	
K1	0.348	
K2	0.0012	

Power Handling @ +77°F (+25°C) (Sea Level) (Cable Only)**		
Power Handling (GHz)		Watts (max.)
0.4		891
1		539
2		363
6		180
12		117
18		88
26.5		65

\* SMA Male & Type N: Assumes use of calibrated torque wrench, proper care and finishing of interface and mated connector is within tolerance limits. QMA: Assumes proper care, care and finishing.

\*\* Connector configuration may limit cable assembly maximum power handling capability.

\*\*\* See SilverLine-VNA data sheet for flex test conditions.

<sup>†</sup> Specifications subject to change without notice.

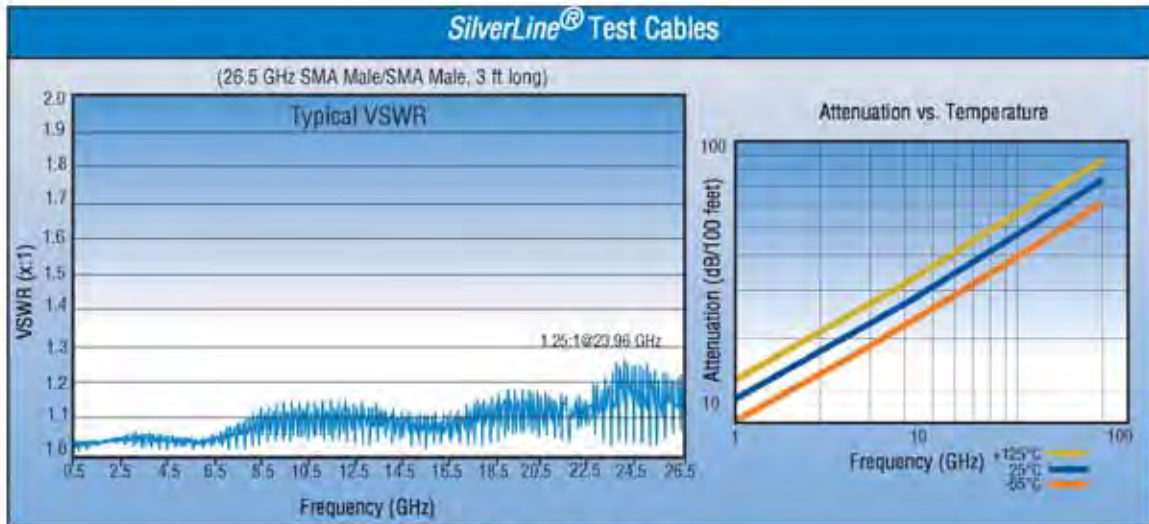

### Ordering Information

U = Unarmored 1ft (0.25m) minimum assembly length  
 A = Armored 2 ft (0.5m) minimum assembly length  
 S = Steel, torque & crush resistant armor 3 ft (1.0m) min. length

SW suffix: Swept Right Angle

Feet: 0.50 ft increments  
 Example: -04.50F = 4.50 ft

Meters: 0.25 m increments  
 Example: -00.75M = 0.75 m

**SLXXX-XXXXXXXXXX-XX.XXX**

F = Feet M = Meters

**Maximum Frequency**

- 04 = 4.0 GHz (BNC size or 1/8" ends)
- 06 = 6.0 GHz
- 18 = 18.0 GHz
- 26 = 26.5 GHz

**Connector Codes (2 or 3 Characters)**

- BM = BNC Male
- SM = SMA Male
- S1T = SMA Male *OneTurn™*
- SF = SMA Female
- SMR = SMA Right Angle
- 35M = 3.5mm Male
- 35F = 3.5mm Female
- 3RF = 3.5mm Ruggedized Female
- NM = Type N Male
- N1T = Type N Male *OneTurn™*
- NF = Type N Female
- NMR = Type N Right Angle
- 70M = 7mm
- 76F = 7-16 Female
- TM = ETNC Male (Extended range)
- TF = ETNC Female (Extended range)
- QMM = QMA Male



3.5mm BNC (L)  
Ruggedized 3.5mm Female (R)



Times QMA Ruggedized™

Labels on unarmored assemblies under 1.5 feet (0.5m) long remain loose to increase flexibility.  
 Some connector combinations and / or lengths may be unavailable.  
 Please contact Times or your Times authorized representative.

First Connector

↓

Second Connector

# SilverLine®

Now there is a SilverLine® Test Cable available for almost every application:

- SilverLine® for high volume production RF testing
- SilverLine®-TG (TuffGrip) for cell site distance to fault testing
- SilverLine®-LP (Low PIM) for cell site Passive Intermodulation testing
- SilverLine®-VNA for 40 GHz R&D testing
- SilverLine®-SF (Super Flex) for more flexibility
- SilverLine®-XF (Extra Flex) for tight areas and breadboard development
- SilverLine®-LL (Low Loss) 30% lower loss
- SilverLine®-DAS (Distributed Antenna System) for in-building wireless radio testing
- SilverLine®-75 for 75 Ohm OEM replacement test port cables
- SilverLine®-TT for phase critical RF/microwave measurements
- SilverLine®-LPA Low PIM adapters

Visit our website or contact your Times local representative for more information.

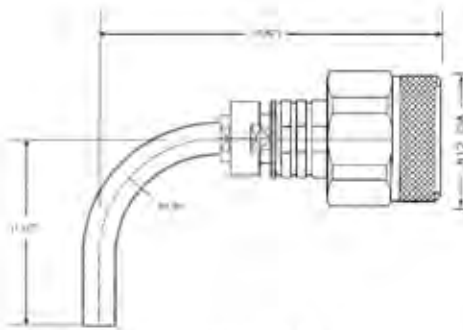

Swept r/a Type N

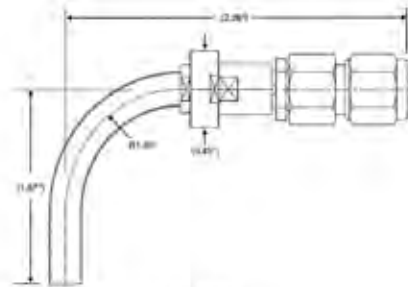

Swept r/a SMA

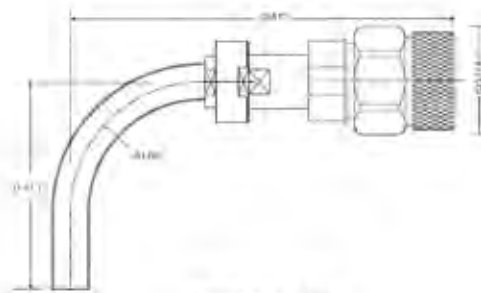

Swept r/a TNC

# SilverLine<sup>®</sup>-LP (Low-PIM)

ISO 9001 Certified

## Coax Test Cables for Passive Intermodulation Testing

- Cellular Site Certification
- Troubleshooting
- Performance Analysis
- Antenna or Radio Equipment Production Test
- **Elliptical Body Improves Grip Force**
- **Now 20% Lighter Weight**
- **Improved Strain Relief**



### Features and Benefits:

- Much easier to handle than raw corrugated cable
- Better than -117dbm (-160dbc) Performance
- Includes a set of low PIM adapters
- Low attenuation
- Rugged, durable, steel armored design
- Water resistant
- RoHS compliant

SilverLine<sup>®</sup>-LP is the first test cable specifically designed for field and production PIM Testing. Unlike standard corrugated test leads that experience rapid failures due to kinking and connector/cable interface breakage, SilverLine<sup>®</sup>-LP is steel armored. It has a large back shell and strain relief to protect the cable to connector interface against almost all possibilities for damage. This robust design improves product life and reduces the occurrence of faulty test results.

SilverLine<sup>®</sup>-LP is ideal for use with Portable PIM analyzers in field test applications. It is also ideal for use with bench top PIM Analyzers in a lab or factory production environment. In the field this reliable, high quality test cable cuts costs by eliminating the need to rebuild or re-terminate a test lead on site or worse, cancel a test entirely. In the factory it saves labor by providing more accurate and consistent results over a far longer product life. This reduces product rejects caused by faulty test leads.

In the uncertain world of PIM, SilverLine<sup>®</sup>-LP is an excellent value, reducing reoccurring costs.

Times Silverline<sup>®</sup> Product Guarantee:  
SilverLine<sup>®</sup>-LP is warranted for one year against defects in workmanship and materials. Excludes damage from over-bending, interface wear, contamination from dirt or other foreign materials, misuse, abuse or unauthorized disassembly.

Analyzer picture courtesy of Anritsu

# SilverLine®-LP

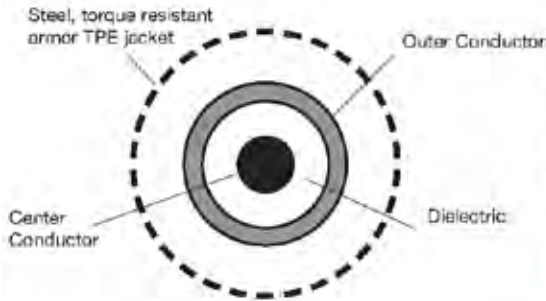

### Cable Construction

**Inner Conductor:** Solid copper clad aluminum

**Dielectric:** Low density tape wrapped PTFE or foam polyethylene

**Shield:** Helical corrugated copper

**Armor:** Full, 100% interlocked spiral steel sheath overlaid with steel, anti-torque braid. Waterproof, UV & abrasion resistant. Black TPE outer jacket

### Connectors:

- Body: Tri-Metal plated brass
- Back Shell: Aluminum
- New Dynaflex® molded strain relief
- Water resistant

**Connector Attachment:** Soldered center contact & shield. Attachment includes a ribbed, wedge clamp-to-armor for the strongest, most robust retention system in the industry.

### \*Achieving a high mating life cycle:

- Inspect and clean interfaces frequently
- Flush with alcohol or swab to remove dirt, debris, and metal particles
- Protect interface from damage
- Replace protective caps when not in use
- Install sacrificial male/female low PIM adapter. Replace when needed

Physical & Mechanical Specifications		
Dimensions	in	mm
Armor	0.59	14.99
Weight: lbs/ft (kg/m)	Cable & Armor Combined: 0.258 (0.383)	
Armor Crush Resistance	>1200 lbs per linear inch	
Bend Radius (min)	7.5"	190.5mm
Mating Life Cycle	1000*	
Storage Temperature	-40°/+185°F	-40°/+85°C
Electrical Specifications		
PIM	-117 dbm (-160 dbc) min. at rest**	
VSWR (ret. loss) DC - 3 GHz	1.25:1 (19db) typ.	1.35:1 (16.54db) max
Impedance	50 Ohms	
Velocity of Propagation	Foam PE: 84%	PTFE tape: 76%
Shielding Effectiveness	> -100db	
Attenuation Max	@ 77°F (+25°C)	
	MHz	db/100 ft      db/100m
	800	3.6              11.8
	900	3.9              13.0
	1800	5.6              18.7
	1900	5.8              19.0
	2100	6.2              20.1
	3000	7.5              24.7
Power handling @77°F (+25°C)(Watts, Avg.)(Sea Level)(Cable Only)		
	MHz	Watts (average)
	800	946
	900	729
	1800	460
	1900	445
	2100	430
	3000	340

*Specifications subject to change without notice.*

A brand new cable can have a break-in period of several hundred flexes.

### \*\*Best Practices for accurate PIM measurements:

- Assure all interfaces are clean
- Push on and hand tighten test lead
- Tighten with a calibrated torque wrench
- DO NOT use wrenches with "teeth"
- -117 to -125 dbm variations are normal
- If spikes occur loosen and retighten one end at a time
- Blow out interfaces with dry compressed air
- Flex as little as possible. DO NOT over-bend

**PIM Performance and Return Loss vs. Frequency**

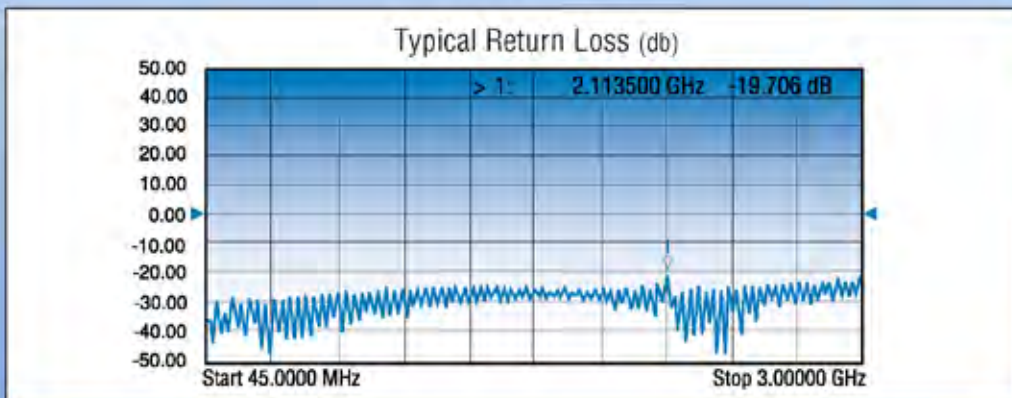
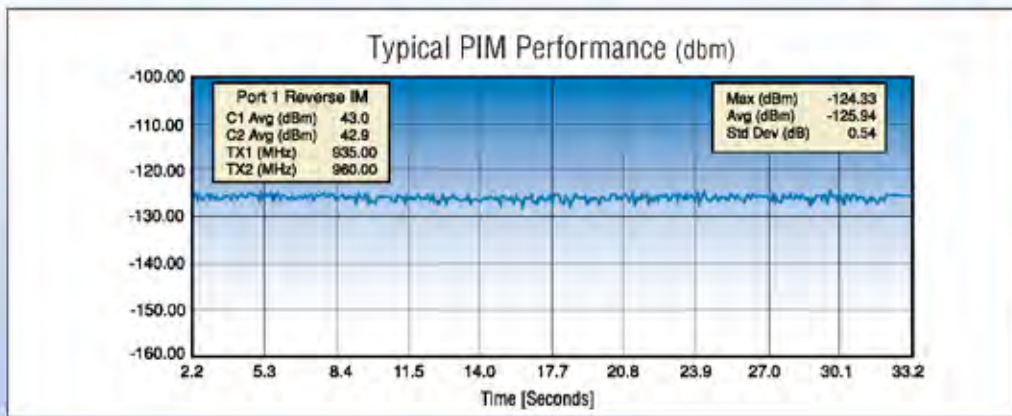

**Ordering Information**

SilverLine, Steel armor, Low PIM

SLSLP03-76M76M-XX.XXMK

3 GHz

K = Includes set of three low PIM adapters.  
Omit for cable assembly only

Low PIM adapter kit PN: 660-0007EA

Every 0.25 meter length from 1.5 meters  
Example: -02.75M = 2.75m

Kit contents:



Female bullet, M-F r/a and M-F connector saver



Heavy duty nylon case with sturdy velcro closure, individual compartments, belt clip and metal lanyard

**Low PIM Accessories**

**Pulsed Power Portable PIM Load (pn 67033)**



pn 67033

Frequency:	690MHz - 2800MHz
Size: in (mm):	6.4L x 1.6w (163 x 40)
Approx Weight:	1.1 lbs. (0.5kg)
Impedance:	50 Ohms
Return Loss:	16 db min
Intermodulation:	-160 dbc (2 x 43 dbm carriers)
Power Handling:	10 watts average
Coupling Torque:	21 ft-lbs (29 N*m) min 36 ft-lbs (49 N*m) max
Operating Temp:	14-130°F (-10-55°C)
Connector Type:	7-16 male, 7-16 female

**Portable PIM Load (pn 67019)**

Frequency:	690MHz - 2800MHz
Size: in (mm):	10.4L x 3w (263 x 76)
Approx Weight:	3.4 lbs. (1.54kg)
Impedance:	50 Ohms
Return Loss:	16 db min
Intermodulation:	-165 dbc (2 x 43 dbm carriers)
Power Handling:	40 watts average
Coupling Torque:	21 ft-lbs (29 N*m) min 36 ft-lbs (49 N*m) max
Operating Temp:	32-95°F (0-32°C)
Connector Type:	7-16 male, 7-16 female



pn 67019

**SilverLine-LPA (Low PIM Adapters)**

3191-331 = 7-16 female bullet	3191-397 = Type N female/Type N female
3191-332 = 7-16 male/female right angle	3191-411 = 4.1/9.5 female/Type N female
3191-376 = 7-16 male bullet	3191-412 = 4.1/9.5 female/Type N male
3191-377 = 7-16 male/female	3191-413 = 4.1/9.5 male/Type N female
3191-378 = 7-16 male/Type N male	3191-414 = 4.1/9.5 male/Type N male
3191-379 = 7-16 male/Type N female	3191-415 = 4.3/10 female/7-16 female
3191-380 = 7-16 female/Type N female	3191-416 = 4.3/10 male/7-16 female
3191-381 = 7-16 female/Type N male	3191-417 = 4.3/10 female/Type N male
3191-382 = 7-16 male/female 45°	3191-418 = 4.3/10 male/Type N male
3191-387 = 7-16 female/female 45°	3191-419 = 4.1/9.5 female/7-16 male
3191-394 = 4.1/9.5 male/7-16 female	3191-420 = 4.1/9.5 male/7-16 male
3191-395 = 4.1/9.5 female/7-16 female	3191-421 = 4.3/10 female/7-16 male
3191-396 = Type N male/Type N male	3191-422 = 4.3/10 male/Type N female

For complete information see the SilverLine® LPA data sheet



# SilverLine®-VNA (26.5 and 40 GHz)

ISO 9001 Certified

## Vector Network Analyzer Test Cables

- Vector Network Analyzer Measurements
- Laboratory Use



SilverLine®-VNA is a precision test cable with excellent loss, VSWR and phase/flexure stability. Protected by a torque and crush resistant armor, SilverLine®-VNA test cables exhibit extraordinary ruggedness comparable to OEM supplied test cables but at a fraction of the cost, making them the ideal choice for daily use in factory and lab applications.

The braided PET outer jacket makes SilverLine®-VNA easy to handle, non-conductive and improves flexibility when compared to extruded jackets. The chrome plated metal back shell maintains the integrity of the cable to connector interface and allows for easy handling.

### Features & Benefits:

- 26.5 and 40 GHz options
- Low loss 40 GHz cables now available!
- Phase, Loss & VSWR stable
- High flex life
- Torque and crush resistant stainless steel armor
- Chrome plated strain relief back shells
- ROHS Compliant

# SilverLine® - VNA

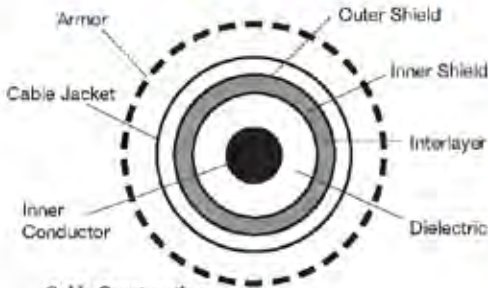

**Cable Construction**

**Inner Conductor:**

Solid silver plated copper

**Dielectric:**

Micro-porous PTFE

**Shield:**

Metalized tape interlayer and silver plated copper round braids

**Jacket: FEP**

**Armor:**

100% coverage, non-interleaved, stainless steel spiral sheath for crush resistance and captured, opposing force steel braid for torque resistance. PET monofilament yarn outer cover to eliminate conductivity and improve handling

**Connectors:**

- Instrument grade
- Passivated stainless steel
- Captive center contacts

**Attachment Method:**

Solder/clamp/crimp. Protective metal back shell

Physical & Mechanical Specifications		
Dimensions	In	mm
Outside Diameter Over Armor	0.43	10.6
Armor Crush Resistance	1050 lbs per linear inch	
Bend Radius (min)	2.5"	
Connector Retention	150 lbs	
Connector Mating Life (min)*	500*	
Electrical Specifications		
VSWR Max.	26.5 GHz	40 GHz
3.6mm	1.35:1	
2.9 mm & 2.4 mm	1.45:1	
Impedance	50 ohms	
Velocity of Propagation	78% nominal	
Shielding Effectiveness	> 100 db	
Capacitance	26 pF/ft	
Phase Stability**	+/- 5° typical, +/- 10° max	
Amplitude Stability (max)**	+/- 0.25 db	
Return Loss Stability**	better than 1.5 db	
Flex Life**	10,000 min, 25,000 typical	
Attenuation, max @ 77° (25° C)		
Frequency (GHz)	dB/100 ft	(dB/100 m)
1	11	(36)
6	28	(82)
12	41	(135)
18	51	(167)
26	63	(206)
40	82	(269)
Max Power Handling @ 77° F (25° C), sea level, (cable only)		
Frequency (Ghz)	Watts	
1	1190	
6	480	
12	310	
18	240	
26	200	
40	150	

*Serialized, plotted loss and VSWR data supplied with every cable*

*\*Specifications subject to change without notice.*

\*Requires mating connections to be clean and within mechanical specifications. Calibrated torque wrench required.

\*\*RF stability and flex life are in accordance with the flex test method example on P.3. Data is for cables 1ft or shorter. Longer cables may exhibit different stability characteristics. A cable will exhibit some instability when new. A very brief period of use is required to alleviate cable component stresses from manufacturing after which the cable will "settle" and maintain the values stated.

40 GHz Flex Test (one full cycle)

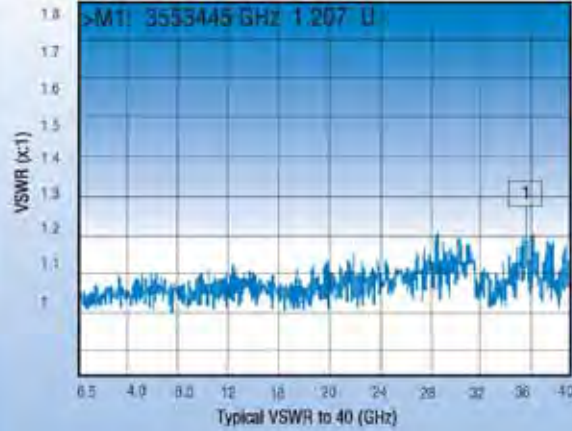

Cable is pulled off center 10" in both directions  
 A brand new cable can have a break-in period of several hundred flexes

Ordering Information

SilverLine, Steel Armor, VNA Style

SLSVXX-XXXXXX-XX.XXX

Maximum Frequency

26 = 26.5 GHz  
 40 = 40 GHz

Feet: 0.5ft increments  
 Meters: 0.25m increments  
 Min length: 1.5ft (0.5 meters)

\*Lengths longer than 6ft (2m) will have an extruded TPR outer jacket replacing the PET weave for improved durability.

F = Feet, M = Meters

- 35M = 3.5mm male (26.5 GHz)
- 35F = 3.5mm female (26.5 GHz)
- 3RF = 3.5mm ruggedized female (26.5 GHz)
- KM = 2.92mm male (40 GHz)
- KF = 2.92mm female (40 GHz)
- KRF = 2.92mm ruggedized female (40 GHz)
- 24M = 2.4mm male (40 GHz)
- 24F = 2.4mm female (40 GHz)
- 2RF = 2.4mm ruggedized female (40GHz)

First Connector



Second Connector

Now there is a SilverLine<sup>®</sup> Test Cable available for almost every application:

- SilverLine<sup>®</sup> for high volume production RF testing
- SilverLine<sup>®</sup>-TG (TuffGrip) for cell site distance to fault testing
- SilverLine<sup>®</sup>-LP (Low PIM) for cell site Passive Intermodulation testing
- SilverLine<sup>®</sup>-VNA for 40 GHz R&D testing
- SilverLine<sup>®</sup>-SF (Super Flex) for more flexibility
- SilverLine<sup>®</sup>-XF (Extra Flex) for tight areas and breadboard development
- SilverLine<sup>®</sup>-LL (Low Loss) 30% lower loss
- SilverLine<sup>®</sup>-DAS (Distributed Antenna System) for in-building wireless radio testing
- SilverLine<sup>®</sup>-75 for 75 Ohm OEM replacement test port cables
- SilverLine<sup>®</sup>-TT for phase critical RF/microwave measurements
- SilverLine<sup>®</sup>-LPA Low PIM adapters

Visit our website or contact your Times local representative for more information.

### **About Times Microwave Systems**

Times Microwave Systems, was founded in 1948 as the Times Wire and Cable Company. Today, the company specializes in the design and manufacture of high performance flexible, semi-flexible and semi-rigid coaxial cable, connectors and cable assemblies. With over 60 years of leadership in the design, development, and manufacture of coaxial products for defense microwave systems, Times Microwave Systems is the acknowledged leader, offering high tech solutions for today's most demanding applications.

Cable assemblies from Times Microwave Systems are used as interconnects for microwave transmitters, receivers, and antennas on airframes, missiles, ships, satellites, and ground based communications systems, and as leads for test and instrumentation applications.

As a highly specialized and technically focused company, Times Microwave Systems has been able to continually meet the challenges of specialty engineered transmission lines for both the military and commercial applications, drawing upon our:

- \* Thousands of unique cable and connector designs
- \* Exceptional RF and microwave design capability
- \* Precise material and process controls
- \* Unique in-house testing capabilities including RF shielding/leakage, vibration, moisture/vapor sealing, phase noise and flammability
- \* Years of MIL-T-81490, MIL-C-87104, and MIL-PRF-39012 experience
- \* ISO 9001 Certification

In 2010, Times Microwave Systems introduced its Times-Protect<sup>™</sup> line of lightning and surge protection solutions to address the challenging needs of wireless systems in the 21st century.

With over 60 years of Times Microwave Systems aerospace cable and connector technology experience and unparalleled design expertise, Times Microwave Systems' staff of Field Applications Engineers can help to provide the right solution for your interconnect applications.

# SilverLine® - VNA Flex Supreme™

## Coaxial Test Cables

- **Communications:**  
*Inter-satellite, point-to-point & wireless HDMI*
- **Wafer Test:**  
*Probe connections*
- **Electronic Warfare:**  
*Targeting/tracking systems*
- **Research:**  
*Component & subsystem development*



Photo courtesy Anritsu



(50 & 67 GHz)

ISO 9001 Certified



SilverLine®-VNA Flex Supreme™ 50 & 67 GHz are extremely flexible, very high frequency coax cable assemblies designed for Vector Network Analyzer use. The high flexibility is ideal for use with small or delicate circuitry. "Light" armoring helps reduce accidental damage without adding excess weight and/or inhibiting flexibility. A Nomex®, abrasion resistant outer braid improves feel and handling characteristics.

SilverLine®-VNA Flex Supreme™ 50 & 67 GHz are also phase, amplitude & return loss stable over many thousands of flexes when handled in accordance with Times' recommendations.

### Features & Benefits:

- Extremely flexible
- Long flex life
- Torque resistant outer armor
- Nomex® outer sleeve
- 2.4mm & 1.85 male and female connectors
- ROHS Compliant

Nomex is a registered trademark of Dupont

## SilverLine®-VNA Flex Supreme™ (50 & 67 GHz)

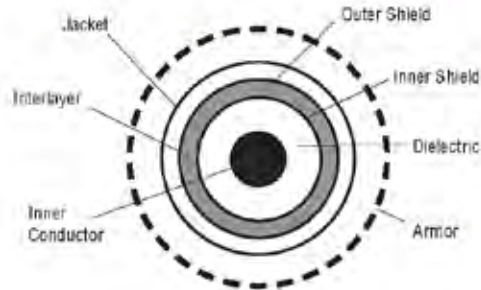

**Cable Construction:**

**Inner Conductor:**

Solid silver plated copper.

**Dielectric:**

Micro-porous PTFE.

**Inner Shield:**

Helically wound silver plated copper flat strip.

**Outer Shield:**

Silver plated copper round wire braid.

**Jacket:** FEP

**Armor:**

Stainless steel flat coil, stainless steel torque resistant wire braid, PVC jacket, Nomex® abrasion resistant sleeve.

**Connectors:**

Stainless steel. Solder contact and braid. Additional crimp to armor for added torque resistance.

Physical & Mechanical Specifications		
Dimensions	in	mm
Outside Diameter	0.308	7.8
Min bend radius (max flex life)	1 (4)	25 (100)
Flex life (min)*	50,000	
Crush Resistance (armored)	188 lbs per linear inch	
Mating Life Cycle**	500	
Temperature Range	-67°/+194°F	-55°/+90°C
Electrical Specifications		
VSWR Max	50 Ghz	67 Ghz
	1.3:1	1.4:1
Impedance	50 Ohms	
Velocity of Propagation	78%	
Shielding Effectiveness	>100dB	
Capacitance	25.9 pF/ft (85pF/m)	
Phase Stability typical (max) *	50 Ghz	67 Ghz
	+/-3 (+/- 8)deg	+/-5 (+/-10)deg
Amplitude Stability	+/- 0.12db	+/-0.15db
Attenuation, max @ 77°F (25°C)	50 Ghz	67 Ghz
		dB/ft (m)
	1.04 (3.42)	1.98 (6.5)
Maximum attenuation at any frequency: (K1 x √(GHz)) + (K2 x fGHz) K1 = 0.671, K2 = 0.0135		
Cable Power Handling @77°F (25°C) sea level, watts, (max)		
Frequency (Ghz)	50 Ghz	67 Ghz
	18w	14w

\* See SilverLine VNA 26.5 & 40 GHz data sheet for test details or contact your Times representative.

A brand new cable can have a break-in period of several hundred flexes.

**Care and Handling Guidelines:**

While armored, 50 & 67 GHz cables are sensitive microwave instruments. Small, flexible cables can easily be forced beyond the recommended minimum bend radius. This will likely degrade or destroy the RF performance. All flexible cables have a limited flex life. Develop procedures that limit flexing. 2.4 and 1.85mm interfaces are delicate. Keep them meticulously clean and the center contacts concentric within the outer contact. Use a microscope to examine if necessary. DO NOT mate connectors that are dirty, suspected of being damaged or outside concentric tolerances. Connectors must be aligned when mating. Misalignment could damage the interfaces and voids the warranty. Test equipment makers publish extensive use and handling procedures on their web sites that cover these and other topics.

**ALWAYS:**

- Inspect interfaces before every mate - Clean if needed.
- Gently start the coupling nut and fully thread with fingers first.
- Hand tighten, but if a calibrated torque wrench is used - 8 lbs max.
- Limit use to experienced technicians.
- Cap connectors and store cables separately in a protective container.
- Keep a spare pair of cables ready, just in case.

**NEVER:**

- Force the cable to bend beyond the recommended minimum radius.
- Force two connectors. If any resistance is felt STOP and examine.
- Mate to another series.
- Mate connectors that are not aligned and concentric.
- Put foreign or dirty objects into the interface.

**Warranty**

Product to be free from workmanship and materials defects and to meet stated data sheet performance for a period of 90 days. Excludes cable or connector interface damage from misuse, abuse, mishandling or mis-mating outside the data sheet recommendations. Warranty claims are subject to factory analysis and may include analysis charges depending on findings.

### Ordering Information

SilverLine Steel Armored, VNA  
(Nomex® cover)

SLSVXX-XXXXXX-XX.XXX

50 = 50 GHz  
67 = 67 GHz

Every half foot or quarter meter, 2 ft (0.75) shortest, 6 ft, (2m) longest.

F = Feet  
M = Meter

Connector Codes  
18M = 1.85mm Male  
18F = 1.85mm Female  
24M = 2.4mm Male  
24F = 2.4mm Female

Full connector  
↓  
Solder  
↓  
Crimp

\*\*Mating life requires hand tightening and/or the strict use of a calibrated torque wrench and clean interfaces that are within the IEEE 287 precision connector standards.

# SilverLine® - VNA (110 GHz)

## Coaxial Test Cables

ISO 9001 Certified

- **Automotive:**  
Collision avoidance radar test
- **Communications:**  
Point-to-point backhaul system test
- **Wafer Test:**  
Probe Connections
- **Electronic Warfare:**  
Targeting/tracking systems.  
Satellite testing
- **Environmental:**  
Remote atmospheric sensing



Photo courtesy of Anritsu



Photo courtesy of Keysight



SilverLine®-VNA 110 GHz is an armored, extremely high frequency coax cable assembly designed for use where waveguide is impractical.

SilverLine®-VNA 110 GHz now offers the user working in these frequencies an alternative to the limited selection of semi-rigid solutions offered by current suppliers. Test technicians experienced in the use and handling of traditional 110 GHz products will find Times' solution to be more than competitive for RF stability and overall product life.

### Features & Benefits:

- Flexible / rebendable
- Steel armored, torque resistant
- Nomex outer sleeve
- 1.0mm male and female connectors
- ROHS Compliant

# SilverLine®-VNA (110 GHz)

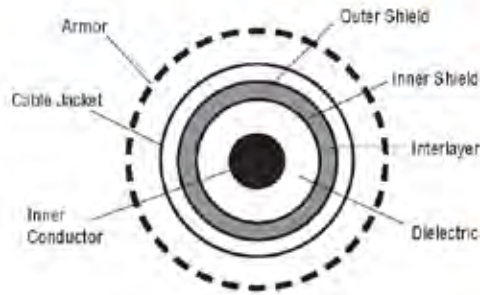

### Cable Construction

#### Inner Conductor:

Solid silver plated copper.

#### Dielectric:

Micro-porous PTFE

#### Inner Shield:

Helically wound silver plated copper flat strip.

#### Outer Shield:

Silver plated copper round wire braid.

#### Jacket: FEP

#### Armor:

Stainless steel flat coil, stainless steel torque resistant wire braid, PVC jacket, nomex abrasion resistant sleeve

### Care and Handling Guidelines:

While armored, 110 GHz cables are sensitive microwave instruments. Flexible cables can easily be forced beyond the recommended minimum bend radius. This will likely degrade or destroy the RF performance. All flexible cables have a limited flex life. Develop procedures that limit flexing. 1.0mm interfaces are delicate. Keep them meticulously clean and the center contacts concentric within the outer contact. Use a microscope to examine if necessary. DO NOT mate connectors that are dirty, suspected of being damaged or outside concentric tolerances. Connectors MUST be aligned when mating. Misalignment will damage the interfaces and void the warranty. Test equipment makers publish extensive use and handling procedures on their websites that cover these and other topics.

### Always:

- Inspect interfaces before every mate. Clean if needed.
- Gently start the coupling nut and fully thread with fingers first. Hand tighten, but use a calibrated torque wrench to tighten. 4 lbs max.
- Limit use to experienced technicians.
- Cap connectors and store cables separately in a protective container.
- Keep a spare pair of cables ready, just in case.

### NEVER:

- Force the cable to bend beyond the recommended minimum radius.
- Force two connectors. If any resistance is felt STOP and examine.

### Warranty

Product to be free from workmanship and materials defects and to meet stated data sheet performance for a period of 90 days. Excludes cable or connector interface damage from misuse, abuse, mishandling or mis-mating outside the data sheet recommendations. Warranty claims are subject to factory analysis and may include analysis charges depending on findings.

Physical & Mechanical Specifications		
Dimensions	in	mm
Outside Diameter	0.18	4.6
Min Bend Radius (Rebendable)	0.40 (1.0)	10 (25)
Mating Life Cycle	500	
Temperature Range	-65° C - +125° C	
Electrical Specifications		
VSWR (DC-110 GHz)	1.25:1 typical 1.40: max	
Impedance	50 Ohms	
Velocity of Propagation	78%	
Shielding Effectiveness	>100 dB	
Capacitance	25.9 pF/ft (85pF/m)	
Phase Stability (over 2000 flexes <sup>1</sup> )	+/- 10°	
Time Delay	4.3ns/m	
Attenuation, max @ 77° (25° C)		
Frequency (GHz)	dB/m	
50	10.76	
72	13.06	
84	14.19	
96	15.24	
110	16.42	

### Connectors:

Stainless steel. Solder contact and braid. Additional crimp to armor for added strength and torsion resistance.

1. Standard "ticktock" flex test. Contact Times for test details.

A brand new cable can have a break in period of several hundred flexes.

### Ordering Information

SilverLine Steel Armored  
(Nomex cover)

SLSV 110-XXXXXX-CM

110 GHz

Whole centimeters.  
(7 cm min, 45 cm max length)

Connector Codes  
10M = 1.0mm Male  
10F = 1.0mm Female

1st Connector  
2nd Connector

<sup>1</sup>Mating life requires hand tightening and/or the strict use of a calibrated torque wrench and clean interfaces that are within the IEEE 287 precision connector standards.



# SilverLine<sup>®</sup>-75 (75 Ohm)

ISO 9001 Certified

## Coaxial Test Cables,

- 75 Ohm OEM replacement test port cables
- CATV
- Subscriber drop products, 75 Ohm coax cable & connector manufacturing

Now +125°C  
Operating  
Temperature  
Range



SilverLine<sup>®</sup>-75 (Ohm) exhibits identical RF performance to major test equipment maker's OEM cables yet with vastly increased durability and ruggedness. That's because SilverLine<sup>®</sup>-75 uses the same robust, proven connector attachment and strain relief systems that have made our 50 Ohm version the first choice of demanding customers around the world.

Times uses only the highest quality, highest performing connector and cable designs in all SilverLine<sup>®</sup> products. SilverLine<sup>®</sup>-75 follows the same tradition.

### Features & Benefits:

- Replaces Agilent 11857 series and similar 75 Ohm test port cables.
- Use with Agilent, Rohde & Schwarz or other 75 Ohm network analyzers
- Precision stainless steel 75 Ohm Type N & F connectors
- Exceptional return loss
- Proven connector attachment method
- ROHS Compliant

R&S ZVL3-75: 75 Ω Vector Network Analyzer  
Reproduced with Permission, Courtesy of Rohde & Schwarz  
Agilent E5091B ENA Series Network Analyzer  
Copyright Agilent Technologies, Inc. 07/01/13  
Reproduced with Permission, Courtesy of Agilent Technologies, Inc.

### Time's Silverline<sup>®</sup> Product Guarantee

*Times will repair or replace your SilverLine test cable at its option if the connector attachment fails within four months of shipment. This guarantee excludes cable or connector voltage damage from misuse or abuse.*

# SilverLine®-75

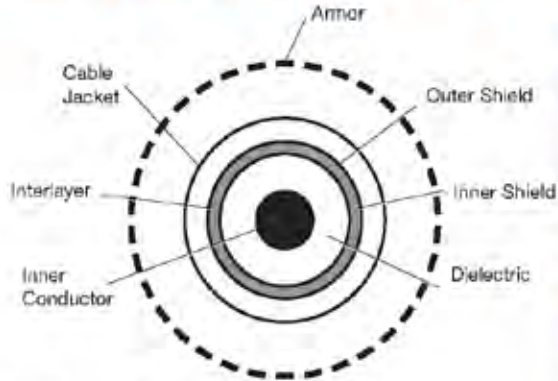

### Cable Construction

**Inner Conductor:** Solid silver plated copper clad steel

**Dielectric:** Solid PTFE

**Shield:** Silver-Plated Copper flat ribbon braid aluminum-polyimide tape interlayer 36 GA silver-plated copper round braid (90%k)

**Jacket:** Clear FEP

**Armor:** PVC and steel options

**PVC:** Steel reinforced, thick wall high flex clear PVC

**TPR/Steel:** 100% coverage, square locked, galvanized steel hose, high angle steel braid and TPR jacket

**Connectors:** Captive contact, stainless steel construction

\*Mating life assumes the use of a calibrated torque wrench, interfaces are clean and within mil spec limits.

Mechanical Specifications		
Dimensions	in	mm
Outside Diameter	0.195	4.95
Armor (optional)	0.450	11.50
Minimum Bend Radius	1	25
Connector Retention	>175 lbs (unarmored) 300 lbs (armored)	
Crush Resistance (armored)	PVC: 1200 lbs./lineal in. Steel: 1500 lbs./lineal in.	
Mating Life Cycle	>5000*	
Temperature Range	-67°/+ 257°F	-55° / +125°C

Electrical Specifications			
VSWR	Max	1 Ghz	3 Ghz
		F Type and Type N	1.11:1 (26 dB RL)
Impedance	75 Ohms		
Velocity of Propagation	70%		
Shielding Effectiveness	>100 dB		
Capacitance	19.2 pF/ft (63pF/m)		
Attenuation, max @77°F (25°C)			
	Frequency (Ghz)	dB/100ft	(dB/100 m)
	0.5	8.4	(27.6)
	1	12.2	(39.4)
	2	17.9	(58.7)
	3	22.7	(74.5)
Cable Power Handling @77°F (25°C) sea level, watts, (max)			
	Frequency Ghz		
	0.5	400	
	1	280	
	2	190	
	3	150	

A brand new cable can have a break in period of several hundred flexes. \*Specifications subject to change without notice

### Ordering Information

U = unarmored  
A = PVC armor  
S = Steel armor

Feet 0.5 ft increments  
Meters 0.25m increments.

**SLX75-XXXXXX-XX.XXX**

75 Ohm

F=Feet, M=Meters  
Connector Codes 2 or 3 Characters

FM = F type male  
FF = F type female  
NM7 = Type N male  
NF7 = Type N female

# SilverLine®-TT (TempTrack)

ISO 9001 Certified

## Coaxial Test Cables For:

- RF Testing From 0°C to +30°C
- Phase Critical RF/Microwave Measurement
- Research and Development

Now +125°C  
Operating Temperature  
on Both Armored and  
Unarmored Style!



SilverLine®-TT features solid TF-4™ dielectric. This proprietary dielectric exhibits smaller and more linear phase change at normal ambient temperatures of 0° C to + 30° C, when compared to solid PTFE. Although somewhat improved phase performance can be achieved using foam, taped or spline dielectrics, ruggedness is sacrificed and the phase performance achieved is not as good as the SilverLine®-TT. The graph below compares solid PTFE to solid TF-4™.

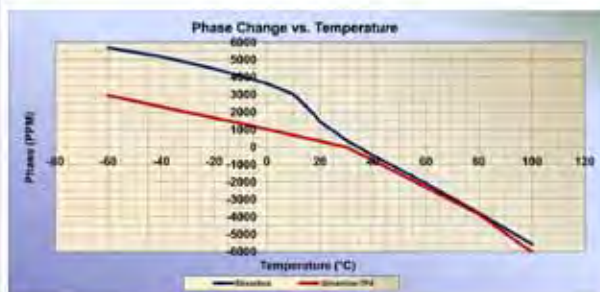

### Time's SilverLine® Product Guarantee

Time's will repair or replace your SilverLine test cable at its option if the connector attachment fails within four months of shipment. This guarantee excludes cable or connector interface damage from misuse or abuse.

### Features & Benefits

- Less and Linear Phase Change From 0° C to + 30° C
- Stainless Steel Connectors
- Ruggedized Cable/Connector Interface
- ROHS Compliant

# SilverLine®-TT

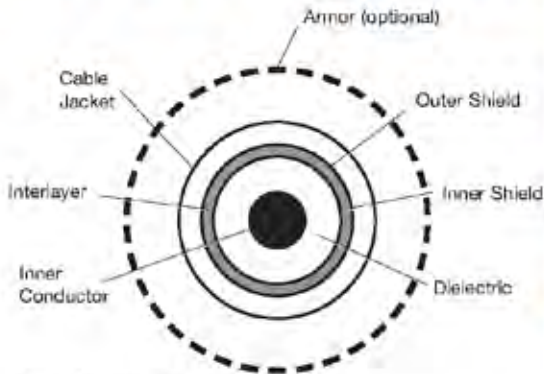

### Cable Construction

**Inner Conductor:** Solid silver plated copper

**Dielectric:** Solid TF-4™

**Shield:** Silver-plated copper flat ribbon braid aluminum-polyimide tape interlayer 36 GA silver-plated copper round braid (90%k)

**Jacket:** Clear FEP

**Armor:** Optional

**Steel Style:** 100% coverage, square locked, galvanized steel hose, high angle steel braid and high temp TPR jacket

### Connectors

- Stainless steel construction
- SMA and Type N OneTurn™ options

\* SMA and Type N mating life assumes the use of a calibrated torque wrench, interfaces are clean and within mil spec limits.

\*\*See SilverLine-VNA data sheet for flex test conditions. A brand new cable can have a break in period of several hundred flexes.

A brand new cable can have a break in period of several hundred flexes.

Specifications subject to change without notice.

Mechanical Specifications		
Dimensions	in	mm
Outside Diameter	0.195	4.95
Armor (optional)	0.450	11.50
Minimum Bend Radius (unarmored)	1	25
Connector Retention	>175 lbs (unarmored) 300 lbs (armored)	
Crush Resistance (armored)	1500 lbs per linear inch	
Mating Life Cycle	>5000*	
Increased Temperature: <small>*(swt @ 32,000 &amp; above)</small>	unarmored or armored: -67/+257°F 55/+125°C	

Electrical Specifications			
VSWR Max		6 GHz	18 GHz
	SMA, Type N, TNC, Swept r/a	1.25:1	1.30:1
	SMA r/a, Type N, r/a	1.30:1	1.35:1

Impedance	50 Ohms		
Velocity of Propagation	70%		
Shielding Effectiveness	>100 dB		
Capacitance	29.0 pF/ft (95.1 pF/m)		
Phase Stability ** (50,000 cycles)	+/-2° through 18 GHz		
Phase change from 0° to +30° C	35 ppm/deg C +/-10 ppm/deg C		
Attenuation, max @77°F (25°C)	Frequency (GHz)	dB/100 ft	(dB/100 m)
	1	12	(40)
	2	18	(59)
	6	35	(115)
	12	53	(174)
	18	69	(225)

Cable Power Handling @77°F (25°C) sea level, watts, (max)		
Frequency GHz		
1	444	
2	304	
6	163	
12	108	
18	86	

### Ordering Information

U = unarmored  
SB = steel armor

Cable Type  
TT = Temp Track

Maximum Frequency  
06 = 6 GHz  
18 = 18 GHz

SW suffix: Swept Flight Angle

**SLXXTTXX-XXXXXXXXXX-XX.XXX**

Feet: 0.5 ft increments  
Meters: 0.25m increments

F = Feet, M = Meters

Connector Codes 2 or 3 Characters

SM = SMA male  
SF = SMA female  
SMR = SMA right angle  
NM = Type N male  
NF = Type N female  
NMR = Type N right angle  
TM = TNC male  
TF = TNC female

First Connector  
↓  
Second Connector

# SilverLine® -SF (Super Flex) & SilverLine® -LL (Low Loss)

ISO 9001 Certified

## Coaxial Test Cables For:

- High volume production test stations
- Research and development labs
- Replacement for OEM test cables



### SilverLine®-SF (Super Flex)

SilverLine®-SF is approximately 40% more flexible than traditional SilverLine®. This is accomplished by replacing the steel center conductor with copper and the FEP outer jacket with polyurethane. SilverLine®-SF retains its bent shape. That is, the cable has memory.

### SilverLine®-LL (Low Loss)

SilverLine®-LL is a low loss version of traditional SilverLine®. Along with the SF changes above the solid core is replaced with tape wrapped PTFE. Flexibility is similarly increased, memory is introduced and the attenuation is reduced by approximately 30%.

Both SilverLine®-SF and SilverLine®-LL use the robust, proven connector attachment and strain relief systems that have become so popular and successful with original SilverLine®.

#### Time's SilverLine® Product Guarantee

Times will repair or replace your SilverLine test cable at its option if the connector attachment fails within four months of shipment. This guarantee excludes cable or connector interface damage from misuse or abuse.

#### Features & Benefits

- 40% More Flexible
- 30% Lower Loss (**SilverLine®-LL Only**)
- Identical Proven Attachment Method
- ROHS Compliant

# SilverLine® -SF & LL

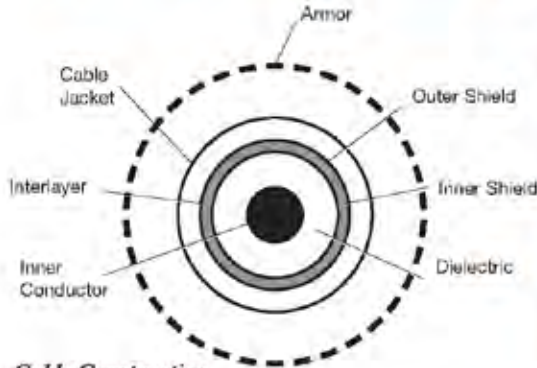

### Cable Construction

- Inner Conductor:** Solid silver plated copper
- Dielectric:** SilverLine-SF® (Super Flex): solid PTFE  
SilverLine-LL® (Low Loss); expanded tape wrapped PTFE
- Shield:** Silver-plated copper flat ribbon braid aluminum-polyimide tape interlayer 36 GA silver-plated copper round braid (90%k)
- Jacket:** Clear polyurethane
- Armor:** Optional
- PVC Style:** Steel reinforced, thick wall high flex life clear PVC
- Steel Style:** 100% coverage, square locked, galvanized steel hose, high angle steel braid and TPR jacket
- Connectors:** Captive contact, stainless steel construction

\*SMA and Type N only. Mating life assumes the use of a calibrated torque wrench, interfaces are clean and within mil spec limits.  
 \*\* See SilverLine-VNA data sheet for flex test conditions. A brand new cable can have a break in period of several hundred flexes.  
 Specifications subject to change without notice

Mechanical Specifications	
Dimensions	in mm
Outside Diameter	0.195 4.95
Armor (optional)	0.450 11.50
Minimum Bend Radius	1 25
Connector Retention	>125 lbs
Crush Resistance (armored)	1200 lbs per linear inch
Mating Life Cycle	>5000*
Temperature Range	-67° / +185°F -55° / +85°C

Electrical Specifications				
VSWR		4 GHz	6 GHz	18 GHz
	Max	1.2:1		
	SMA, SMA, Type N, TNC, Swept r/a		1.25:1	1.30:1
	SMA r/a, N r/a, 7mm		1.25:1	1.35:1

Impedance	50 Ohms		
Velocity of Propagation	Super Flex: 70%	Low Loss: 76%	
Shielding Effectiveness	>100 dB		
Capacitance	SF 29.4 pF (96.4 pF/m)	LL: 26.7 pF/ft (87.5 pF/m)	
Phase Stability (25,000 cycles)**	±.5° through 18 GHz		
Attenuation, max @77°F (25°C)	Super Flex	Low Loss	
Frequency (GHz)	dB/100 ft. (dB/100 m)	dB/100 ft. (dB/100 m)	dB/100 ft. (dB/100 m)
1	12 (40)	10 (33)	
2	18 (59)	15 (49)	
6	34 (112)	26 (85)	
12	52 (174)	37 (121)	
18	68 (224)	46 (150)	

Cable Power Handling @77°F (25°C) sea level, watts, (max)		
Frequency GHz	Super Flex	Low Loss
1	539	340
2	353	240
6	180	130
12	117	90
18	88	70

### Ordering Information

U = unarmored  
 A = PVC armor  
 S = Steel armor

Cable Type:  
 SF = Super Flex  
 LL = Low Loss

Maximum Frequency:  
 04 = 4 GHz (610 Only)  
 06 = 6 GHz  
 18 = 18 GHz

SW suffix: Swept Right Angle

Feet: 0.5 ft increments  
 Meters: 0.25m increments  
 F=Feet, M=Meters

Connector Codes 2 or 3 Characters:  
 SM = SMA male  
 SF = SMA female  
 S11 = SMA male one turn\*\*  
 SMR = SMA right angle  
 NM = Type N male  
 N1T = Type N One Turn\*\*  
 NF = Type N female  
 NMR = Type N right angle  
 ZOM = 2mm  
 TM = TNC male  
 TF = TNC female  
 QMM = QMA male

First Connector  
 Second Connector

SLXXXXX-XXXXXXXXXX-XX.XXX

A brand new cable can have a break in period of several hundred flexes.

SILVERLINE TEST CABLES

# SilverLine<sup>®</sup>-DAS (Low PIM)

ISO 9001 Certified

## *Low PIM Test Leads for DAS Systems and Component Testing*

- *Rugged Armored Construction For:*
  - *Consistent Measurements*
  - *Long Life*
- *Superior to Un-armored Corrugated Test Leads*



SilverLine<sup>®</sup>-DAS is specifically designed for stable, low PIM performance and to withstand the flexing that occurs when testing indoor DAS systems in tight spaces. It features steel armor to resist over-bending and a highly robust strain relief. Both contribute to long product life and consistent, repeatable measurements.

SilverLine<sup>®</sup>-DAS is available with 7-16 DIN and Type N connectors. It is suitable for use with the latest generation of portable field PIM analyzers.

### Features & Benefits

- Won't kink like corrugated cable
- Better than -117 dbm (-160 dbc) performance\*
- Low attenuation
- RoHS compliant

\*Cable at rest or in motion  
Portable Analyzer picture courtesy of Kaelus

# SilverLine®-DAS

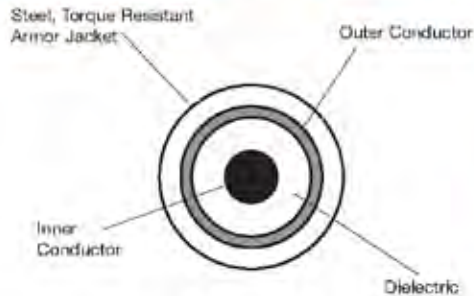

### Cable Construction

- Inner Conductor:** Solid copper clad aluminum
- Dielectric:** Low density tape wrapped PTFE or foam polyethylene
- Shield:** Helical corrugated copper
- Armor:** Full, 100% non-interleaved spiral steel sheath. Waterproof, UV and abrasion resistant, Black TPE outer jacket
- Connectors:** Low PIM, Tri-Metal plated brass

**Connector Attachment:** Fully soldered center contact and shield. Attachment includes a three layer, glue lined, heat activated sleeving with progressive flexibility

### To Achieve High Mating Life:

- Inspect and clean interfaces frequently
- Flush with alcohol or swab to remove dirt, debris, and metal particles
- Protect interface from damage
- Replace protective caps when not in use
- Install sacrificial male/female low PIM adapter

### Best Practices For Accurate PIM Measurements:

- Assure all interfaces are clean
- Push on and hand tighten rest lead
- Tighten with a calibrated torque wrench
- DO NOT use wrenches with "teeth"
- -117 to -125 dbm variations are normal
- If spikes occur loosen and redighten one end at a time
- Blow out interfaces with dry compressed air
- Flex as little as possible. DO NOT over-bend

Mechanical Specifications		
Dimensions	in	mm
Armor	0.48	12.0
Armor Crush Resistance	>600 lbs. per linear inch	
Minimum Bend Radius	4.5	115
Length Tolerances	+2% of length	
Storage Temperature	-40° / +185°F	-40C / +85C
Electrical Specifications		
Passive Intermodulation (min)	-117 dbm (-160 dbc) at rest or in motion	
VSWR (ret. loss) DC -3 Ghz	1.25:1 (19db) typ. 1.35:1 (36.54 db) max	
Impedance	50 Ohms	
Velocity of Propagation	Foam PE: 84%	PTFE tape: 76%
Shielding Effectiveness	>100db	
Capacitance	24.2 pF/ft	79.4 pF/meter
Attenuation, max @77°F (+25°C)		
	Frequency (Mhz)	dB/100 ft (dB/100 m)
	800	5.3 (17.4)
	900	5.6 (18.5)
	1800	8.2 (26.9)
	1900	8.5 (27.7)
	2100	8.9 (29.2)
	3000	10.9 (35.6)
Power Handling @77°F (+25°C) (Watts, average) (Sea Level) (Cable Only)		
	Mhz	Watts (average)
	800	420
	900	400
	1800	270
	1900	260
	2100	250
	3000	210

*\*Specifications subject to change without notice*

### Ordering Information

For the most accurate measurement results limit length to 2.75 meters.

Silverline Steel  
Armor, DAS

Feet: 0.6 ft increments  
Meters: 0.25 m increments  
(3 ft (1m) started length)

**SLSDAS03-XXXXXX-XX.XXX**

F - Feet, M - Meters

Frequency  
in GHz

Connector Codes: 2 or 3 Characters  
NM - Type N Male  
FM - 7-16 Male

First Connector  
↓  
Second Connector

A brand new cable can have a break in period of several hundred boxes.



**Engineered Products:**

# SilverLine®-XF (Extra Flex)

*ISO 9001 Certified*
**Coaxial Test Cables**

- 36% Smaller Diameter
- Improved Flexibility
- RF Stable With Flexure
- Triple Shielded, 18 GHz Operation
- **Linear Phase Change From 0° to 30°C**
- Injection-Molded Strain Relief

**Now Available  
in a  
High Temperature  
Version!**



Test fixture photo courtesy of Inter-Continental Microwave  
[www.icmicrowave.com](http://www.icmicrowave.com)

SilverLine®-XF was designed for testing delicate components such as exposed RF circuits with edge launch connectors. Thin, lightweight and flexible this coax makes handling PC boards easy yet does not compromise RF stability and isolation. Using Times' proprietary TF-4 dielectric SilverLine®-XF goes one step further, exhibiting linear phase change from 0°C to +30°C (see graph).

SilverLine®-XF uses the same robust, proven connector attachment system that has made SilverLine® the preferred choice in RF test labs everywhere. A new injection-molded strain relief system designed to match the cable's flexibility assures the cable will bend tightly but not fail prematurely behind the connector.

- Popular Lengths & Configurations in Stock  
(visit [timesmicrowave.com/silverline-products/](http://timesmicrowave.com/silverline-products/))

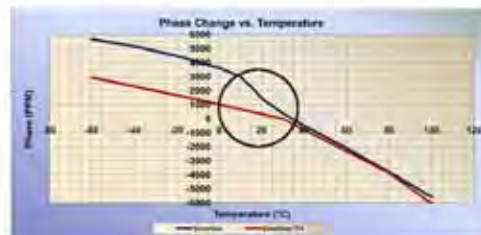

**Engineered Products:**

# SilverLine®-XF

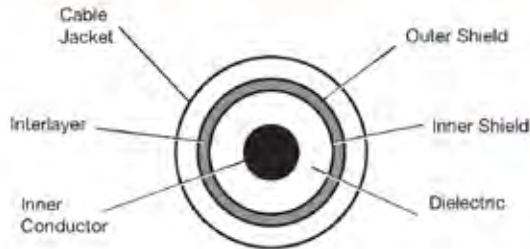

**Cable Construction**

**Inner Conductor:** Solid silver-plated copper clad steel

**Dielectric:** Solid TF-4

**Shield:** Silver-plated copper flat ribbon braid, aluminum-polyimide tape interlayer, silver-plated copper round wire braid, (90%k)

**Jacket:** Clear polyurethane (HT version = FEP)

**Connectors:**

- Stainless steel
- Solder/Clamp attachment
- Captive contact construction

\* Mating life assumes the use of a calibrated torque wrench, interfaces are clean and within mil specs limits.

Specifications subject to change without notice.

Mechanical Specifications		
Dimensions	in	mm
Outside Diameter	0.150	3.80
Minimum Bend Radius	0.75	19
Mating Life Cycle	>5000*	
Temperature Range	-55°/+85°C (HT = +125°C)	
Electrical Specifications		
VSWR through 18 GHz	1.30:1 typ, 1.35:1 max	
Impedance	50 Ohms	
Velocity of Propagation	70%	
Shielding Effectiveness	>100 dB	
Capacitance	28.8 pF/ft. (94.4 pF/m)	
Phase Stability ** (75,000 cycles)	+/-3° @ 18 GHz	
Attenuation, max @77°F (25°C)		
	Frequency (GHz)	dB/100 ft (dB/100 m)
	1	16 (52)
	2	24 (79)
	6	43 (141)
	12	64 (210)
	18	81 (257)
Attenuation at any frequency formula: $0.49656 \sqrt{f} + 0.0007989 f$ (f=freq in MHz)		



\*\* Phase stability data IAW Times' phase/flex test criteria as demonstrated above. A brand new cable can have a break-in period of several hundred flexes.

### Ordering Information

**SilverLine**  
Unarmored  
**EXtraFlex**

Omit for polyurethane jacket version  
HT = FEP high temperature version

**SLUXFXX18-XXXX-XX.XXX**

Feet 0.5 ft increments  
Meters 0.25m increments  
F=Feet, M=Meters

06 = 6 GHz  
18 = 18 GHz

Connector Codes, 2 Characters:  
SM = SMA male  
NM = Type N male

First Connector  
Second Connector

**Engineered Products:**

# SilverLine®-LPA

*DIN, Mini-DIN & Type N for PIM Sensitive Systems*

**Low PIM Adapters**

*ISO 9001 Certified*

- Cellular or Wireless
- Tower or in-building
- Production or laboratory

3191-331



3191-332



3191-376



3191-377



3191-378



3191-379



3191-380



3191-381



SilverLine®-LPA low PIM adapters exhibit exceptional PIM performance in any cellular or wireless frequency range.

Times uses only the most robust designs for long product life regardless of the environment. All product is 100% tested and individually packaged prior to shipping.

3191-394



3191-395



3191-396



3191-397



**Two 45° Configurations!**

3191-382



3191-387



**Engineered Products:**

# SilverLine®-LPA

Mechanical Specifications			
Body and Coupling Nut	Ti-metal plated brass		
Center Contact	Gold or Silver Plated		
Mating Life	500 min*		
Temperature Range	-40° C to +85° C		
Electrical Specifications			
Frequency, Max	All straight configurations	45° or right angle	
	6 GHz	8GHz	
Impedance	50 Ohms		
VSWR, Max	All straight configurations	45° or right angle	
	1.1:1 (3 GHz) 1.2:1 (6 GHz)	1.25:1	
PIM* (IM3)	-125 dBm @ -3 dBm (2 x 43 dBm carriers)		
Insertion Loss, Max (dB)	DIN-N or N-N	DIN/DIN, all 4:1 & all 4:3 config's	45° or right angle
	3 GHz	0.10	0.05
	6 GHz	0.12	0.15
			N/A

\* Interfaces must be clean and proper torque forces applied  
 A brand new cable can have a break-in period of several hundred flexes.

Ordering Information			
<b>Individual Adapters:</b>	<b>Kit Designator</b>		<b>Kit Designator</b>
3191-331 = 7-16 female bullet	A	3191-411 = 4.1/9.5 female/Type N female	Q
3191-332 = 7-16 male/female right angle	B	3191-412 = 4.1/9.5 female/Type N male	P
3191-376 = 7-16 male bullet	C	3191-413 = 4.1/9.5 male/Type N female	Q
3191-377 = 7-16 male/female	D	3191-414 = 4.1/9.5 male/Type N male	R
3191-378 = 7-16 male/Type N male	E	3191-415 = 4.3/10 female/7-16 female	S
3191-379 = 7-16 male/Type N female	F	3191-416 = 4.3/10 male/7-16 female	T
3191-380 = 7-16 female/Type N female	G	3191-417 = 4.3/10 female/Type N male	U
3191-381 = 7-16 female/Type N male	H	3191-418 = 4.3/10 male/Type N male	V
3191-382 = 7-16 male/female 45°	I	3191-419 = 4.1/9.5 female/7-16 male	W
3191-387 = 7-16 female/female 45°	J	3191-420 = 4.1/9.5 male/7-16 male	X
3191-394 = 4.1/9.5 male/7-16 female	K	3191-421 = 4.3/10 female/7-16 male	Y
3191-395 = 4.1/9.5 female/7-16 female	L	3191-422 = 4.3/10 male/Type N female	Z
3191-396 = Type N male/Type N male	M		
3191-397 = Type N female/Type N female	N		
<b>Standard</b> (small) SilverLine Adapter Kits: (Hard case with foam insert containing seven adapters)			
660-0234: Contains one each A, D, E, F, G, H and I			
660-0235: Contains one each A, D, G, H, I, K and L			
660-0236: Contains one each A, C, M, T, W, Y and Z			
<i>Specifications subject to change without notice</i>			
<b>Custom</b> (Large) SilverLine Adapter Kits: (Hard case with foam, 10 pieces min, 20 max (max of four 45's or 7/8's combined)			
SLK-XXXX . . . (Insert designator from above in alphabetical order (20 max) . Duplicate designators acceptable)			

## Engineered Products:

# SilverLine®-TG TuffGrip®

## Coax Test



ISO 9001 Certified

### For Wireless System Testing:

- Cell Site Antenna & Cable Sweep Test
- Troubleshooting
- RF Maintenance
- Field RF Test



Shortened Grip



Patented \*

Anritsu StaffMaster™ courtesy of Anritsu Co.

**SilverLine®-TG (TuffGrip®)** test cables are designed for sweep testing cellular infrastructure site cables and antennas. Its unique features were designed by field technicians *for* field technicians.

TuffGrip® employs a hefty handgrip at the system end to better withstand the rigors of field work. It meets the demands of repeated mating and unmating to cell tower cables with connectors that may have degraded from exposure.

The robust hand grip allows the user to apply as much resistance as necessary to properly torque the system cable connector, while preventing excess torque from being applied to the high performance test cable. A proper connection may now be made quickly with a single wrench.

TuffGrip® test cables are double steel armored and anti-torquing, yet they are completely flexible. All connectors are stainless steel for thousands of mating cycles.

### Features & Benefits:

- RF stable with flexure for accurate measurements
- Rugged construction for long life in field use
- > 50,000 flex life cable for added assurance
- High frequency operation to meet future needs
- Permanently attached heavy duty protective caps
- **NEW short grip option**

*Times' SilverLine-TG® Replacement Guarantee*  
Times will repair or replace your SilverLine-TG test cable at its option if the connector attachment fails within one year of shipment. Excludes cable or connector interface damage from misuse or abuse.

**Engineered Products:**

# SilverLine®-TG

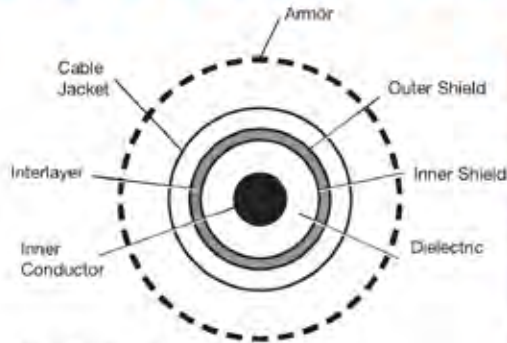

**Cable Construction**

- Inner Conductor:** Solid silver plated copper clad steel
- Dielectric:** Solid PTFE
- Shield:** Silver-plated copper flat ribbon braid  
Aluminum-Polyimide tape interlayer 36 GA silver-plated copper round braid (90%k)
- Jacket:** Clear FEP
- Armor:** Full, 100% non-interleaved spiral steel sheath overlaid with captured, opposing-force structure for anti-torque resistance. Waterproof, UV resistant, black TPR outer jacket

**Connectors**

- Passivated stainless steel finish
- Captive contact
- Precision grade connectors
- 7-16 male includes retractable coupling nut with Times exclusive OneTurn™ fast mating feature
- Kaurf/hex Type N coupling nut

**Connector Attachment**

- System side: TuffGrip® (patented)
- Analyzer side: solder/clamp/crimp

**Ordering Information**

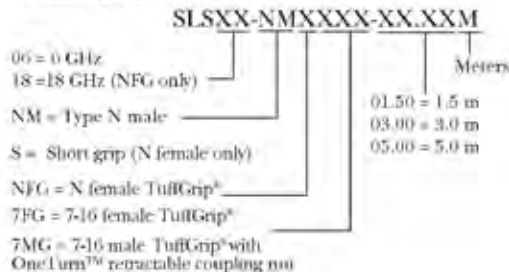

TuffGrip®			
<b>Mechanical Specifications</b>			
Dimensions	in	mm	
Armored O.D.	0.430	10.92	
Minimum Bend Radius	2.50	63.5	
Connector Retention	> 290 lbs.		
Armor Crush Resistance	> 1200 lbs. per linear inch		
Mating Life Cycle	> 5,000*		
Flex Life	> 50,000**		
Temperature Range	-67°/+221°F	-55°/+105°C	
<b>Electrical Specifications</b>			
Impedance	50 ohms		
Velocity of Propagation	70 %		
Shielding Effectiveness	>100 dB		
Capacitance	29.4 pF/ft = 96.4 pF/m		
Phase Stability (ten, 4" radius, 180° reverse bends)	DC to 10 GHz: +/- 1.1° 10 to 18 GHz: +/- 2.0°		
VSWR Max	Type N	6 GHz	18 GHz
		1.20:1	1.35:1
7-16	1.25:1		
	<b>Attenuation Max @ +77°F (+25°C)</b>		
Frequency (GHz)	dB/100 ft	dB/100 m	
1.0	12	40	
2.0	18	59	
6.0	34	112	
18.0	68	224	
<b>Power Handling @ +77°F (+25°C) (Sea Level) (Cable Only***)</b>			
Frequency (GHz)	Watts (max.)		
1	539		
2	363		
6	180		
18	88		

\* Specifications subject to change without notice.  
\*\* Maximum life of a certified cyclic stress, from one uncoupling of mating, and must ensure a stress free state.  
\*\*\* Maximum load under use to be specified.  
\*\*\*\* Connector configurations only listed with optional resistance jacket/mating capability.

# Intra-Flex™

ISO 9001 Certified

*High Performance, Low Loss  
In-The-Box RF Interconnects*



#### Features & Benefits:

- Low loss improves performance
- Braid design maintains shielding when flexed and bent
- True flexible cable simplifies and eases installation
- Eliminates solder joint failures
- Buy as Assemblies or Cable and Connectors
- Short Lead Time

**Intra-Flex™** is an in-the-box interconnect solution. A true, flexible coax it can be used as an alternative to 0.141" diameter copper semi-rigid, tin-soaked braid cable or other similar sized solid PTFE dielectric cables. Intra-Flex™ exhibits approximately 12% lower attenuation compared to 0.141" sized coax. Used as a substitute for semi-rigid coax, Intra-Flex™ eliminates the need for custom-formed configurations dedicated to a specific location within the system. It also eliminates the time and cost to develop drawings depicting the shape. Used as a substitute for tin-soaked braid cable, Intra-Flex™ assemblies eliminate failures from cracked solder joints.

Intra-Flex™ may also be substituted where RG 58, RG142, RG223 and RG400 are used. It exhibits 36% to 51% improvement in maximum attenuation, and achieves 25dB to 50dB better shielding than these RG cables. Intra-Flex™ may be repeatedly flexed without return loss performance degradation or shortening the products life cycle due to mechanical failure.

# Intra-Flex™ Specifications:

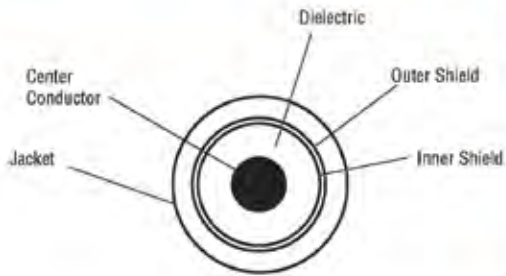

### Cable Construction

**Center Conductor:** Bare Copper, 0.044" (1.12 mm)

**Dielectric:** Foam PE

**Inner Shield:** Silver Plated Copper Flat Ribbon Braid 0.126" (3.20 mm)

**Outer Shield:** 36GA Tinned Copper Round Wire Braid, 90%k 0.148" (3.76 mm)

**Jacket:** Black PVC 0.195" (4.95 mm)

### Connector Construction

- Body: Nickel Plated Brass
- Center Pin: Gold Plated
- Dielectric: PTFE

Physical & Mechanical Specifications		
Dimensions	in	mm
Outside Diameter	0.195	4.95
Weight per 1kft (305m)	40 lbs	18 kg
Minimum Bend Radius	0.2	5
Preferred Bend Radius	0.5	13
Number of Bends*	min radius: < 10	preferred radius: < 25
Operating Temperature	-40°C to + 85°C	
Connector Retention	> 15 lbs	> 6.8 kg
Termination Method	Solder center, crimp braid	
Length Tolerances (< 2.0', 0.6m)	-0,+0.4	-0,+10
Electrical Specifications		
VSWR (max through 3 GHz)	1.25:1	
Impedance	50 Ohms	
Velocity of Propagation	83 %	
Shielding Effectiveness	>80 dB	
Capacitance	24.3 pF/ft = 79.70 pF/meter	
<b>Attenuation max @ +77°F (+25°C)</b>		
(MHz)	dB/100 ft	dB/100 m
150	4.2	13.8
450	7.3	23.9
900	10.3	33.8
2000	15.6	51.2
2400	17.3	56.1
3000	19.4	63.6
Max attenuation, any frequency:	$(0.33404 \times \sqrt{F\text{ghz}}) + (0.000364 \times F\text{ghz})$	
Connector Attenuation, max	Straight	Right Angle
(Includes attachment mismatch)	$(0.1 \times \sqrt{F\text{ghz}})$	$(0.15 \times \sqrt{F\text{ghz}})$
<b>Power Handling**</b>		
(MHz)	77°F (25°C)	104°F (40°C)
150	590	480
450	340	270
900	240	190
2000	160	130
2400	140	110
3000	126	105

\*Assumes a single location on the cable is repeatedly flexed, and 3 GHz operation.  
 \*\* Sea level

Specifications subject to change without notice.

All **Intra-Flex™** cable assemblies are 100% RF tested for VSWR and insertion loss.



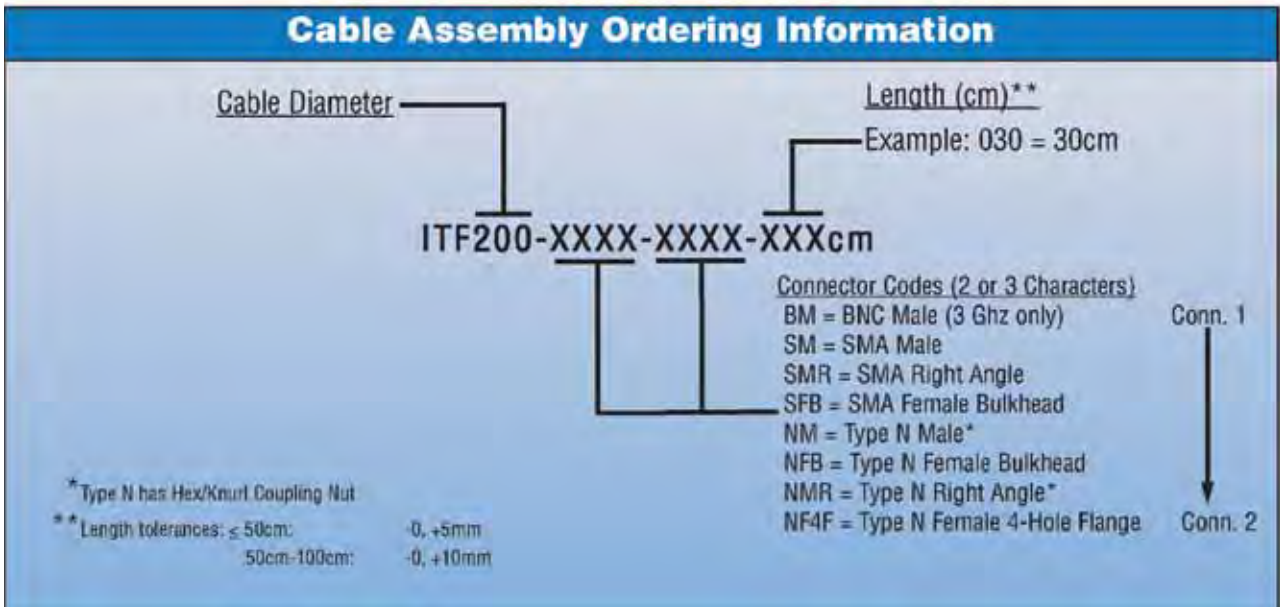
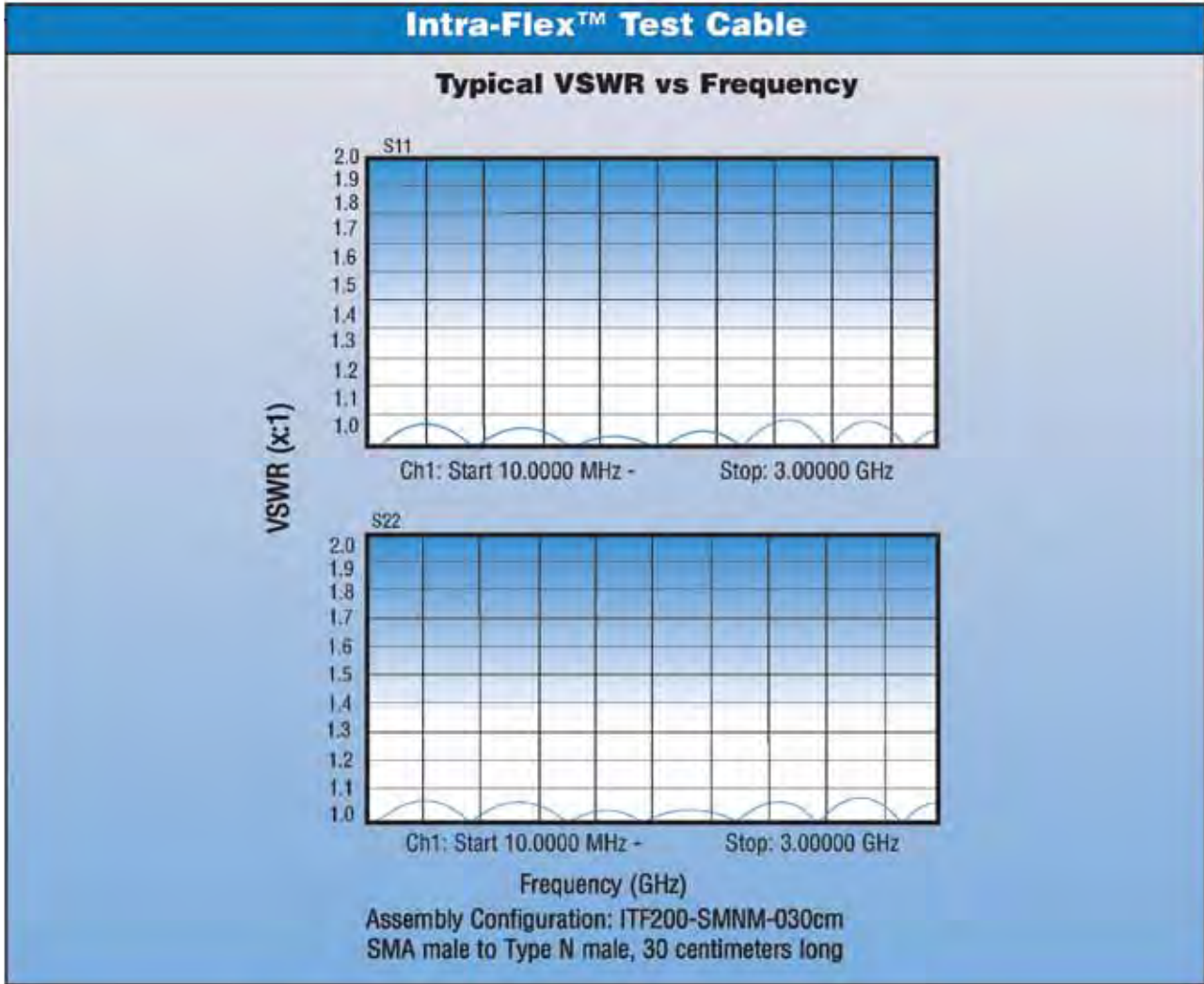

**Connector Ordering Information:**

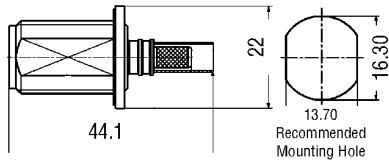

Type N Female Bulkhead  
3190-2430

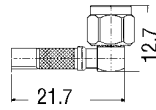

SMA Right Angle  
3190-2112

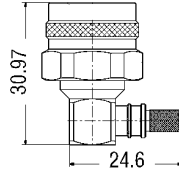

Type N Right Angle  
3190-2425

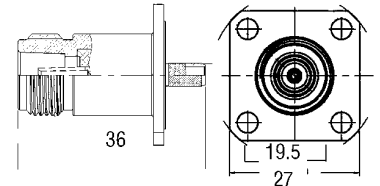

Type N Female 4-Hole Flange  
3190-2213

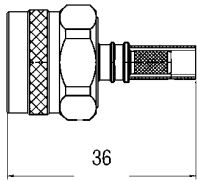

Type N Male  
3190-2349

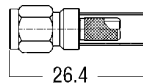

SMA Male  
3190-2214

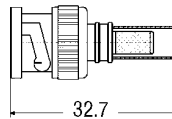

BNC Male  
3190-2429

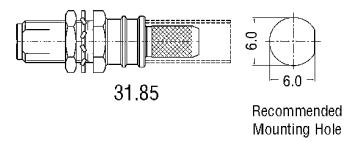

SMA Female Bulkhead  
3190-2428

\*Dimensions in millimeters

**Cable Ordering Information:**

Number: MI 55026

# LMR-SW™

ISO 9001 Certified

## New 50 Ohm Low Loss, Low PIM Coaxial Cables

- Seamless Thin Wall Aluminum Outer Conductor
  - Pinhole-free
  - Eliminates Risk of Seam Failure
  - 100% RF Shielded
- Easy to Attach Connectors
- Excellent PIM Performance Typically < -170 dBc
- Low VSWR and Attenuation
- Tools and Accessories Available



LMR-SW396  
LMR-SW540



LMR-SW 50 Ohm low loss coaxial cables employ a thin wall, seamless aluminum outer conductor which results in an exceptional combination of low loss, light weight and flexibility. Superior in electrical performance to corrugated copper cables with easily field installed connectors and lighter weight, LMR-SW cable also provides significant cost savings.

LMR-SW cables are the perfect solution for PIM-sensitive installations such as full duplex transmission lines and co-located sites. They are suitable for short to medium height tower runs and flexible enough to be used as jumper cables for both indoor and outdoor applications up to 5.8 GHz.

The high quality connectors are user-friendly and provide excellent and reliable performance when installed with the easy-to-use cable prep tools. Typical PIM performance better than -170 dBc can be achieved consistently. Grounding kits, hangers and other installation accessories are also available.

#### Features:

- Low Loss
- Low PIM
- Outstanding Connector Retention Strength
- Type N and 716 DIN Connectors Available
- Easy Handling
- 10 Year Warranty

# LMR-SW™

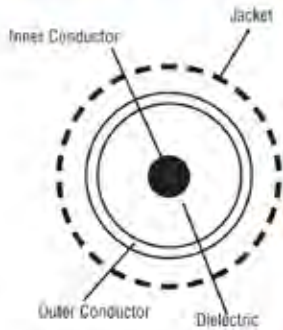

**Cable Construction**

**Inner Conductor:** Copper Clad Aluminum

**Dielectric:** Foamed Polyethylene

**Outer Conductor:** Seamless Aluminum Tube

**Jacket:** Polyethylene, Outdoor, Black

Physical Specifications		LMR-SW396		LMR-SW540			
Overall Diameter: in (mm)		0.450	(11.4)	0.610	(15.5)		
Bend Radius: in (mm)		2.00	(51)	3.00	(76)		
Bending Moment: ft-lbs (N-m)		2.0	(2.71)	6.3	(8.80)		
Tensile Strength lb (Kg)		220	(99.8)	375	(170)		
Flat Plate Crush Strength: lbf (kgf)		95	(43)	90	(40)		
Weight: lbs/1000 ft (lb/km)		70	(104)	138	(205)		
Environmental Specifications							
Installation Temperature Range °F/°C		-40 / +185		(-40 / +85)			
Storage Temperature Range °F/°C		-40 / +185		(-40 / +85)			
Operating Temperature Range °F/°C		-40 / +185		(-40 / +85)			
Electrical Specifications							
Velocity of Propagation: %		87		88			
Impedance: Ohms		50 +/- 1		50 +/- 1			
Capacitance: pF/ft (pF/m)		24.2 pF/ft (76.2 pF/m)		23.1 pF/ft (75.8 pF/m)			
Inductance: pH/ft (uH/m)		0.058 pH/ft (0.19 uH/m)		0.058 pH/ft (0.19 uH/m)			
Shielding Effectiveness: dB		>100		>100			
Passive Intermodulation (PIM): dBc		< -170		< -170			
Center Conductor DC Resistance: Ohms/1000 ft (km)		0.82 (2.69)		0.42 (1.38)			
Shield DC Resistance: Ohms/1000 ft (km)		0.85 (2.79)		0.63 (2.07)			
Attenuation & Average Power @ MHz:		(dB/100 ft) (dB/100 m) (kW)		(dB/100 ft) (dB/100 m) (kW)			
30		0.51	1.7	5.76	0.36	1.2	8.35
50		0.66	2.2	4.44	0.47	1.5	6.44
150		1.16	3.8	2.52	0.83	2.7	3.67
200		1.34	4.4	2.16	0.96	3.1	3.16
300		1.66	5.5	1.75	1.18	3.9	2.56
400		1.94	6.4	1.50	1.37	4.5	2.21
450		2.06	6.8	1.41	1.46	4.8	2.07
900		3.00	9.8	0.97	2.11	6.9	1.44
1800		4.41	14.5	0.66	3.06	10.0	0.99
1900		4.55	14.9	0.64	3.15	10.3	0.96
2500		5.32	17.5	0.54	3.67	12.0	0.82
3500		6.47	21.2	0.45	4.43	14.5	0.68
4900		7.90	25.9	0.36	5.36	17.6	0.56
5800		8.74	28.7	0.33	5.90	19.4	0.51
Connectors							
N Male		EZ-SW396-NMC		EZ-SW540-NMC			
N Female		EZ-SW396-NFC		EZ-SW540-NFC			
716 Din Male		EZ-SW396-716MC		EZ-SW540-716MC			
716 Din Female		EZ-SW396-716FC		EZ-SW540-716FC			
Connector Installation Tools							
Complete Tool Kits		TK-SW396EZ		TK-SW540EZ			
Ground Kits							
Exact Fit Ground Kits		GK-S396TT		GK-S540TT			

# SPPTM Low Loss, Low PIM Coaxial Cables

ISO 9001 Certified

## Flexible, Low PIM, Plenum Rated Jumper Cables

- -160 dBc PIM for optimal system performance
- UL listed, type CMP (plenum), UL file #E-170516
- Super flexible for ease of installation
- Corrugated copper outer conductor providing greater than 100dB of shielding
- Durable FEP outer jacket is suitable for both indoor and outdoor use

**Major Carrier Approved!**



SPP-250-LLPL, SPP-375-LLPL, SPP-500-LLPL 50 Ohm low loss, low PIM cable assemblies

- Available in any required connector configuration and length
- Large selection of standard configurations for quick delivery
- Check inventory at StockCheck on our website
- Available connector interfaces: SMA, N, 7-16 DIN, 4.1/9.5 mini DIN, 4.3/10.0 DIN
- 100% tested for static and dynamic PIM, VSWR and insertion loss
- Serial marker band includes PIM, VSWR & IL test data which is retained and accessible on the Times website
- 10 year Times Microwave warranty

Typical VSWR & Insertion Loss

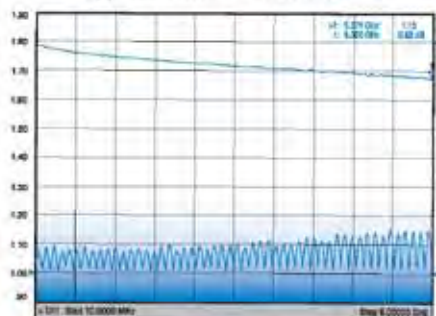

SPP250NMNM1.0M

Dynamic PIM Test Results



# SPP™ Coaxial Cables

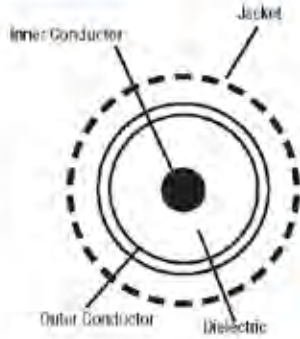

### Cable Construction

#### Inner Conductor:

- SPP-250-LLPL: Solid bare copper
- SPP-375-LLPL: BCCAl
- SPP-500-LLPL: BCCAl

#### Dielectric: Expanded PTFE

#### Outer Conductor: Seam welded, corrugated copper tube

#### Jacket: PEP

• Jumpers available in any length with most popular connector combinations

• iBwave VEX files available at [www.iBwave.com](http://www.iBwave.com)

Physical Specifications	SPP-250-LLPL	SPP-375-LLPL	SPP-500-LLPL
Jacket: PEP: OD: in/(mm)	0.210 (7.1)	0.402 (10.2)	0.500 (12.4)
Outer Conductor: Corrugated Copper Tube: OD: in/(mm)	0.250 (6.3)	0.380 (9.6)	0.472 (12.1)
Dielectric: LD PTFE: OD: in/(mm)	0.190 (4.8)	0.285 (7.1)	0.370 (9.4)
Center Conductor: OD: in/(mm)	0.060 (1.7)	0.100 (2.7)	0.136 (3.5)
Bend Radius: in/(mm)	1.25 (32)	1.38 (35)	1.50 (38)
Bending Moment: ft lbs (N m)	0.8 (1.0)	1.7 (2.0)	2.0 (2.4)
Tensile Strength: lb (kg)	150 (68.2)	175 (79.5)	210 (95.5)
Flat Plate Crush Strength: lbf/in (kg/mm)	100 (1.8)	100 (1.8)	110 (2.0)
Weight: lbs/1000 ft (kg/km)	65 (78)	115 (127)	200 (167)

Environmental Specifications	SPP-250-LLPL	SPP-375-LLPL	SPP-500-LLPL
Installation Temperature Range °C/°F	-55/+200 (-67/+392°)	-55/+200 (-67/+392°)	-55/+200 (-67/+392°)
Storage Temperature Range °C/°F	-55/+200 (-67/+392°)	-55/+200 (-67/+392°)	-55/+200 (-67/+392°)
Operating Temperature Range °C/°F	-55/+200 (-67/+392°)	-55/+200 (-67/+392°)	-55/+200 (-67/+392°)

Electrical Specifications	SPP-250-LLPL	SPP-375-LLPL	SPP-500-LLPL
Velocity of Propagation: %	76%	76%	76%
Impedance: Ohms	50 Ohms	50 Ohms	50 Ohms
Capacitance: pF/ft (pF/m)	27.0 (8.2)	27.5 (8.4)	29.0 (8.8)
Inductance: pH/ft (pH/m)	0.067 (0.22)	0.067 (0.22)	0.069 (0.23)
Shielding Effectiveness: dB	>100	>100	>100
Center Conductor DC Resistance: Ohms/1000 ft (km)	3.0 (9.54)	1.30 (4.26)	0.82 (2.70)
Shield DC Resistance: Ohms/1000 ft (km)	2.00 (6.55)	1.52 (4.96)	1.00 (3.29)
Attenuation & Average Power @ MHz	dB/100 ft (dB/100m) Kw	dB/100 ft (dB/100m) Kw	dB/100 ft (dB/100m) Kw
450	2.8 (12.5) 1.01	2.5 (8.4) 2.11	2.3 (7.4) 2.63
700	4.8 (15.8) 0.81	3.2 (10.6) 1.67	2.8 (9.3) 2.07
850	5.3 (17.4) 0.73	3.6 (11.7) 1.50	3.2 (10.4) 1.87
1900	8.1 (26.6) 0.47	5.5 (18.1) 0.97	4.9 (16.1) 1.20
2100	8.8 (21.1) 0.45	5.8 (19.1) 0.92	5.2 (17.0) 1.14
2300	9.0 (29.5) 0.43	5.1 (20.1) 0.87	5.4 (17.9) 1.08
2400	9.2 (30.1) 0.42	5.3 (20.5) 0.85	5.6 (18.3) 1.05
4900	13.5 (44.4) 0.28	9.3 (30.7) 0.57	8.4 (27.5) 0.70
5800	14.8 (46.7) 0.26	10.3 (33.8) 0.52	9.2 (30.3) 0.63

Connectors (solder body) (Connectors with BLK suffix packed 100 pieces per bulk pack)	SPP-250-LLPL	SPP-375-LLPL	SPP-500-LLPL
N Male Straight	TC-SPP250-NM-LP (3190-233BLK)	TC-SPP375-NM-LP (3190-295BLK)	TC-SPP500-NM-LP (3190-294BLK)
N Male Right Angle	TC-SPP250-NM-RA-LP (3190-233BLK)	-	-
N Female	TC-SPP250-FM-LP (3190-255BLK)	TC-SPP375-FM-LP (3190-306BLK)	TC-SPP500-FM-LP (3190-301BLK)
N Female Bulkhead	TC-SPP250-FM-BH-LP (3190-233BLK)	-	-
7-16 DIN Male Straight	TC-SPP250-716M-LP (3190-783BLK)	TC-SPP375-716M-LP (3190-294BLK)	TC-SPP500-716M-LP (3190-294BLK)
7-16 DIN Female Straight	TC-SPP250-716F-LP (3190-300BLK)	TC-SPP375-716F-LP (3190-619BLK)	-
7-16 DIN Male Right Angle	TC-SPP250-716M-RA-LP (3190-254BLK)	-	-
RMA Male Straight	TC-SPP250-RMA-LP (3190-294BLK)	-	-
SMA Male Right Angle	TC-SPP250-SMA-RA-LP (3190-300BLK)	-	-
4.3/9.5 mm UFN Male Straight	TC-SPP250-4195M-LP (3190-301BLK)	-	-
4.1/8.5 mm DIN Right Angle	TC-SPP250-4195M-RA-LP (3190-302BLK)	-	-
4.3/10.0 DIN Male Straight	TC-SPP250-4310M-LP (3190-614BLK)	-	TC-SPP500-4310M-LP (3190-621BLK)
4.2/10.0 DIN Male Straight (Snap-on)	TC-SPP250-4310MS-LP (3190-620BLK)	-	-
4.3/10.0 DIN Male Right Angle	TC-SPP250-4310M-RA-LP (3190-615BLK)	-	-
4.3/10.0 DIN Female Straight	TC-SPP250-4310F-LP (3190-619BLK)	-	-

## SPP™ Coaxial Cables

### Smart Part Number Key for SPP Low PIM Jumpers

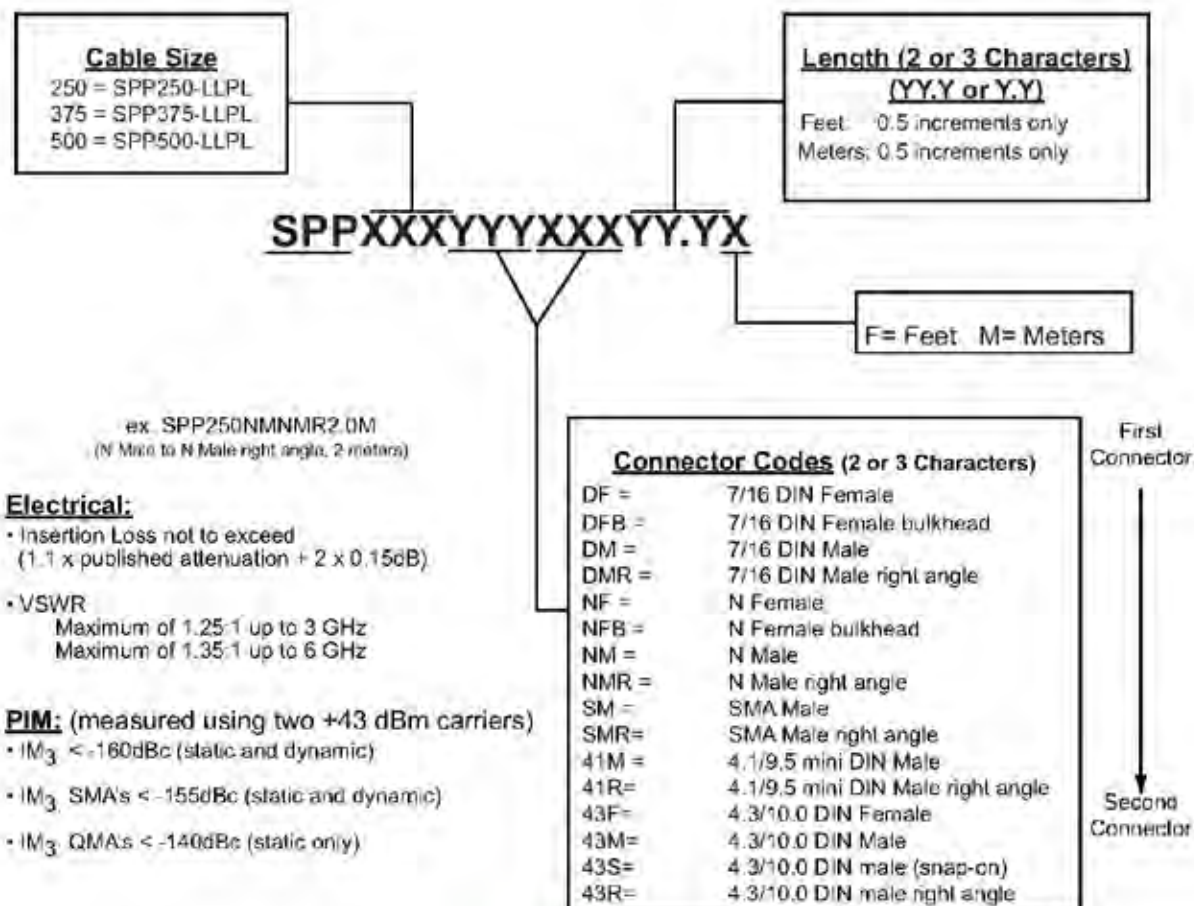

Many assembly configurations are available from stock.  
Refer to the on-line [StockCheck](#) for specific configurations.

Superflexible, PIM rated, Plenum rated - SPP Jumpers are the ideal DAS interconnect solution

- PIM, VSWR and Insertion Loss Test Results marked on each jumper
- Better than -160 dBc PIM Static and Dynamic • UL/CSA Plenum Listed and Printed with Reference File #E-170516, Type CMP, to UL Standard 444
- Superflexible corrugated outer conductor for flexibility and 100% shielding
- Broadband Performance up to 6.0 GHz
- Available with most popular connector interfaces including N, 7-16 DIN, 4.3-10.0, 4.1-9.5 DIN and SMA  
SPP-250 1/4" superflexible  
SPP-375 3/8" superflexible  
SPP-500 1/2" superflexible





# SPO™ Low Loss, Low PIM Coaxial Cables

## Flexible, Low PIM, Jumper Cables

- -160dBc PIM for optimal system performance
- Super flexible for ease of installation
- Corrugated copper outer conductor providing greater than 100dB Shielding
- Durable black polyethelene outer jacket suitable for outdoor use

**Major  
Carrier  
Approved!**

ISO 9001 Certified



SPO-250, SPO-375, SPO-500 50 Ohm low loss, low PIM cable assemblies

- Available in any required connector configuration and length
- Large selection of standard configurations for quick delivery
- Check inventory at StockCheck on our website
- 100% tested for static and dynamic PIM, VSWR and insertion loss
- Serial marker band includes PIM, VSWR and IL test data which is retained and accessible on the Times website
- 10 year Times Microwave warranty

Typical VSWR

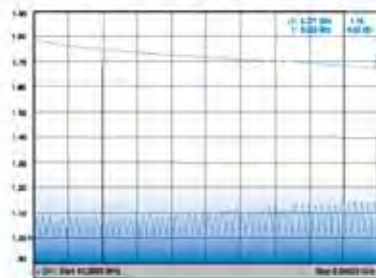

SPO250NMNML0M

Dynamic PIM Test Results

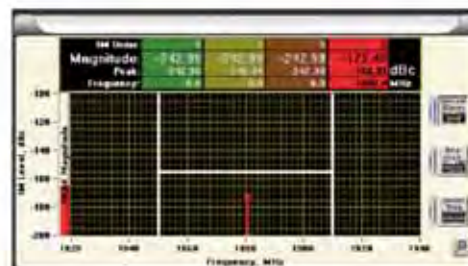

# SPO™ Coaxial Cables

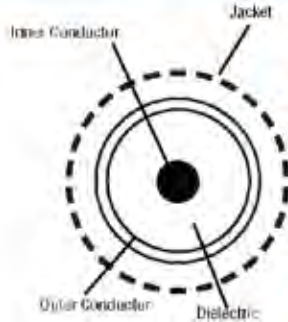

### Cable Construction

#### Inner Conductor:

- SPO-250: Solid bare copper
- SPO-375: BCCAL
- SPO-500: BCCAL

#### Dielectric: Foam Polyethylene

#### Outer Conductor: Seam welded corrugated copper tube

#### Jacket: UV and sunlight resistant black polyethylene

Physical Specifications		SPO-250	SPO-375	SPO-500
Jacket: Extruded Polyethylene; OD: in(mm)		0.300 (7.7)	0.425 (10.8)	0.525 (13.4)
Outer Conductor: Corrugated Copper Tube; OD: in(mm)		0.250 (6.3)	0.390 (9.6)	0.472 (12.1)
Dielectric: Foam PE; OD: in(mm)		0.190 (4.8)	0.265 (7.1)	0.370 (9.4)
Center Conductor: Solid BCCAL; OD: in(mm)		0.075 (1.9)	0.110 (2.8)	0.142 (3.6)
Bend Radius: in(mm)		1.0 (25)	1.7 (43)	2.0 (51)
Bending Moment: ft-lbs (N-m)		1.84 (2.5)	2.07 (2.8)	3.25 (4.4)
Tensile Strength: lb (kg)		150 (68.2)	175 (79.5)	210 (95.5)
Flat Plate Crush Strength: lb/in (kg/mm)		100 (1.8)	100 (1.8)	110 (2.0)
Weight: lbs/1000 ft (kg/km)		46 (67)	76 (120)	140 (210)
Environmental Specifications				
Installation Temperature Range °F(°C)		-25/+60°C	-25/+60°C	25/+60°C
Storage Temperature Range °F(°C)		-70/+85°C	-70/+85°C	-70/+85°C
Operating Temperature Range °F(°C)		-40/+85°C	-40/+85°C	-40/+85°C
Electrical Specifications				
Velocity of Propagation %		84	84	84
Impedance: Ohms		50	50	50
Capacitance: pF/ft (pF/m)		24.2 (79.4)	24.3 (79.7)	25.2 (82.7)
Inductance: pH/ft (uH/m)		0.61 (0.200)	0.61 (0.200)	0.63 (0.205)
Shielding Effectiveness: dB		>100	>100	>100
Center Conductor DC Resistance: Ohms/1000 ft(km)		3.00 (9.34)	1.30 (4.26)	0.92 (2.70)
Shield DC Resistance: Ohms/1000 ft(km)		2.00 (6.56)	1.52 (4.93)	1.00 (3.28)
Attenuation & Average Power @ MHz				
	dB/100 ft (dB/100m)	kW	dB/100 ft (dB/100m)	kW
450	4.1 (13.3)	1.01	2.8 (9.1)	2.11
700	5.1 (17.1)	0.81	3.5 (11.5)	1.67
850	5.7 (18.7)	0.73	3.9 (12.8)	1.50
1900	9.09 (29.2)	0.47	6.0 (21.0)	0.97
2100	9.4 (30.8)	0.46	6.4 (21.0)	0.82
2300	9.9 (32.5)	0.43	6.7 (22.0)	0.87
2400	10.1 (33.1)	0.42	6.9 (22.6)	0.85
4900	15.0 (48.2)	0.28	10.5 (34.4)	0.57
5000	16.5 (51.1)	0.26	11.6 (36.0)	0.52
10.9 (35.8)			10.9 (35.8)	0.63
Connectors (solder body) (connectors with BLK suffix packed 100 pieces per bulk pack)				
N Male Straight	TC-SPO250-NM-1P (3190-6063BLK)	TC-SPO375-NM-1P (3190-6059BLK)	TC-SPO500-NM-1P (3190-6004BLK)	
N Male Right Angle	TC-SPO250-NM-RA-1P (3190-6055BLK)	TC-SPO375-NM-RA (3190-6011BLK)	TC-SPO500-NM-RA-1P (3190-6006BLK)	
N Female	TC-SPO250-NF-1P (3190-6054BLK)	TC-SPO375-NF-1P (3190-6060BLK)	TC-SPO500-NF-1P (3190-6005BLK)	
7-16 DIN Male Straight	TC-SPO250-716M-1P (3190-6066BLK)	TC-SPO375-716M-1P (3190-6062BLK)	TC-SPO500-716M-1P (3190-6008BLK)	
7-16 DIN Male Right Angle	TC-SPO250-716M-RA-1P (3190-6068BLK)	TC-SPO375-716M-RA-1P (3190-6064BLK)	TC-SPO500-716M-RA-1P (3190-6009BLK)	
7-16 DIN Female Straight	TC-SPO250-716F-1P (3190-6057BLK)	TC-SPO375-716F-1P (3190-6063BLK)	TC-SPO500-716F-1P (3190-6067BLK)	
SMA Male Straight	TC-SPO250-SM-1P (3190-8182BLK)	N/A	N/A	

- Jumpers available in any length with most popular connector combinations
- iBwave VEX files available at [www.iBwave.com](http://www.iBwave.com)

# SPO™ Coaxial Cables

## Smart Part Number Key for Low PIM Jumpers

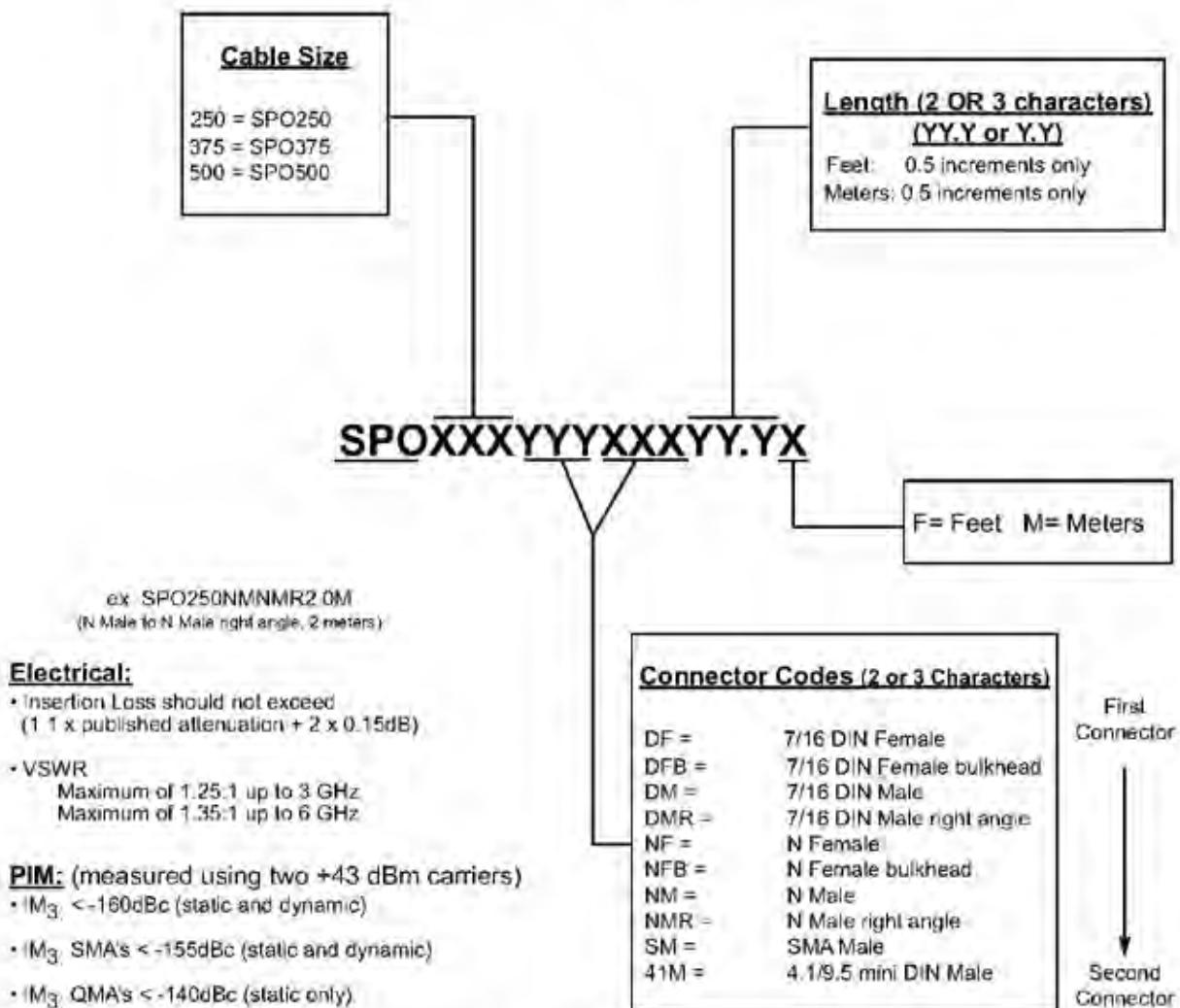

**Many assembly configurations are available from stock.  
Refer to the on-line [StockCheck](#) for specific configurations.**

Superflexible, PIM rated, outdoor - SPO Jumpers are the ideal low PIM interconnect solution

- PIM, VSWR and Insertion Loss Test  
Results marked on each jumper
- Better than -160 dBc PIM Static and Dynamic
- Suitable for outdoor use
- Superflexible corrugated outer conductor for flexibility and 100% shielding
- Broadband Performance up to 6.0 GHz
- Available with most popular connector interfaces  
SPO-250 1/4" superflexible  
SPO-375 3/8" superflexible  
SPO-500 1/2" superflexible



# SPF™ Low Loss, Low PIM Coaxial Cables

## Fire Retardant Low Loss, Low PIM Cable Assemblies

- -160 dBc PIM for optimal system performance
- UL listed, type CMR (riser) UL file #E-170516
- Super flexible for ease of installation
- Corrugated copper outer conductor providing greater than 100dB Shielding
- Durable fire retardant, low smoke polyolefin outer jacket is suitable for outdoor use

**Major  
Carrier  
Approved!**

ISO 9001 Certified



SPF-250, SPF-375, SPF-500 50 Ohm low loss, low PIM cable assemblies

- Available in any required connector configuration and length
- Large selection of standard configurations for quick delivery
- Check inventory at StockCheck on our website
- 100% tested for static and dynamic PIM, VSWR and insertion loss
- Serial marker band includes PIM, VSWR and IL test data which is retained and accessible on the Times website
- 10 year Times Microwave warranty

Typical VSWR

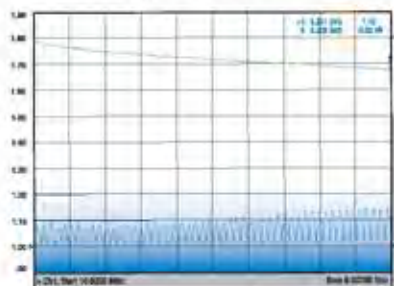

SPF250NMNML0M

Dynamic PIM Test Results



# SPF™ Coaxial Cables

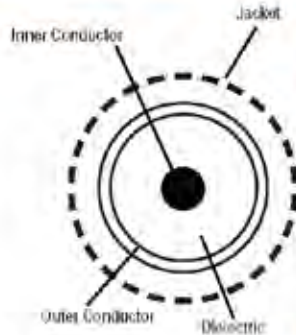

### Cable Construction

- Inner Conductor:**
- SPF-250: Solid bare copper
  - SPB-375: BCCAL
  - SPF-500: BCCAL

**Dielectric:** Foam Polyethylene

**Outer Conductor:** Seams welded, corrugated copper tube

**Jacket:** UV and sunlight resistant black flame retardant, non halogen, polyethylene

Physical Specifications	SPF-250	SPF-375	SPF-500
Jacket: Extruded Polyethylene; OD: in/(mm)	0.300 (7.7)	0.425 (10.8)	0.525 (13.4)
Outer Conductor: Corrugated Copper Tube; OD: in/(mm)	0.250 (6.3)	0.380 (9.6)	0.472 (12.1)
Dielectric: Foam PE; OD: in/(mm)	0.190 (4.8)	0.235 (6.1)	0.370 (9.4)
Center Conductor: Solid BCCAL; OD: in/(mm)	0.075 (1.9)	0.110 (2.8)	0.142 (3.6)
Bend Radius: in/(mm)	1.0 (25)	1.7 (43)	2.0 (51)
Bending Moment: ft-lbs (N-m)	1.94 (2.5)	2.07 (2.8)	3.25 (4.4)
Tensile Strength: lb (kg)	150 (68.2)	175 (79.5)	210 (95.5)
Flat Plate Crush Strength: lbf/in (kg/mm)	100 (1.8)	100 (1.8)	119 (2.0)
Weight: lbs/1000 ft (kg/km)	46 (67)	78 (120)	140 (210)

Environmental Specifications	SPF-250	SPF-375	SPF-500
Installation Temperature Range °F/°C	-25/+60°C	-25/+60°C	-25/+60°C
Storage Temperature Range °F/°C	-70/+85°C	-70/+85°C	-70/+85°C
Operating Temperature Range °F/°C	-40/+85°C	-40/+85°C	-40/+85°C

Electrical Specifications	SPF-250	SPF-375	SPF-500
Velocity of Propagation: %	84	84	84
Impedance: Ohms	50	50	50
Capacitance: pF/ft (pF/m)	24.2 (79.4)	24.3 (79.7)	25.2 (82.7)
Inductance: pH/ft (nH/m)	0.61 (0.200)	0.61 (0.200)	0.63 (0.205)
Shielding Effectiveness: dB	>100	>100	>100
Center Conductor DC Resistance: Ohms/1000 ft (km)	3.00 (0.94)	1.20 (4.26)	0.82 (2.70)
Shield DC Resistance: Ohms/1000 ft (km)	2.00 (0.56)	1.52 (4.86)	1.00 (3.23)
Attenuation & Average Power @ MHz	dB/100ft (dB/100m) kW	dB/100ft (dB/100m) kW	dB/100ft (dB/100m) kW
	4.1 (13.3) 1.01	2.5 (8.1) 2.11	2.2 (7.2) 2.53
	5.1 (17.1) 0.81	3.5 (11.5) 1.67	2.8 (9.1) 2.07
	5.7 (18.7) 0.73	3.9 (12.8) 1.50	3.1 (10.2) 1.87
	6.8 (29.2) 0.47	6.0 (19.7) 0.97	4.8 (15.7) 1.20
	9.4 (30.8) 0.45	6.4 (21.0) 0.92	5.2 (17.1) 1.14
	9.9 (32.5) 0.43	6.7 (22.0) 0.87	5.6 (18.4) 1.08
	10.1 (33.1) 0.42	6.9 (22.6) 0.85	5.7 (18.7) 1.05
	15.0 (49.2) 0.28	10.5 (34.4) 0.59	9.0 (31.5) 0.70
	16.9 (54.1) 0.26	11.8 (38.0) 0.52	10.9 (35.8) 0.63

Connectors (solder body) [ connectors with BLK suffix packed 100 pieces per bulk pack ]	SPF-250	SPF-375	SPF-500
N Male Straight	TC-SP0250-NM-LP (3190-6053BLK)	TC-SP0375-NM-LP (3190-6059BLK)	TC-SP0500-NM-LP (3190-6004BLK)
N Male Right Angle	TC-SP0250-NM-RA-LP (3190-6056BLK)	TC-SP0375-NM-RA-LP (3190-6061BLK)	TC-SP0500-NM-RA-LP (3190-6063BLK)
N Female	TC-SP0250-NF-LP (3190-6054BLK)	TC-SP0375-NF-LP (3190-6060BLK)	TC-SP0500-NF-LP (3190-6005BLK)
7-16 DIN Male Straight	TC-SP0250-716M-LP (3190-6058BLK)	TC-SP0375-716M-LP (3190-6062BLK)	TC-SP0500-716M-LP (3190-6066BLK)
7-16 DIN Male Right Angle	TC-SP0250-716M-RA-LP (3190-6059BLK)	TC-SP0375-716M-RA-LP (3190-6064BLK)	TC-SP0500-716M-RA-LP (3190-6068BLK)
7-16 DIN Female Straight	TC-SP0250-716F-LP (3190-6057BLK)	TC-SP0375-716F-LP (3190-6063BLK)	TC-SP0500-716F-LP (3190-6067BLK)
SMA Male Straight	TC-SPP250-SM-LP (3190-6182BLK)	N/A	N/A

\* Jumpers available in any length with most popular connector combinations.

SPF™ products are included in the iBwave In-Building Network Components Database at [iBwave.com](http://iBwave.com)

# SPF™ Coaxial Cables

## Smart Part Number Key for Low PIM Jumpers

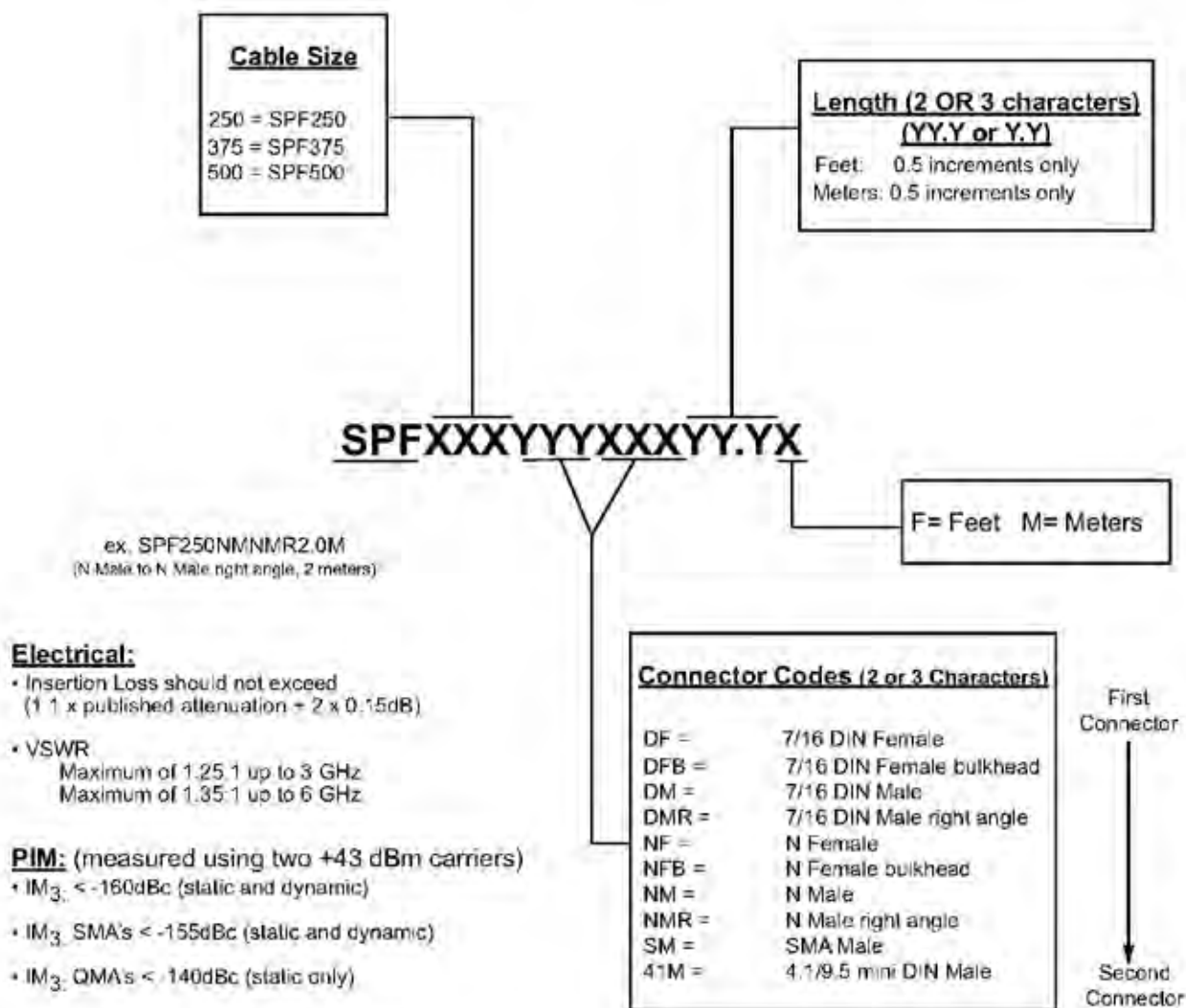

Superflexible, PIM rated, Riser rated - SPF Jumpers are the ideal DAS interconnect solution

- PIM, VSWR and Insertion Loss Test  
Results marked on each jumper
- Better than -160 dBc PIM Static and Dynamic
- UL/CSA Riser Listed and Printed with Reference File #E-170516, Type CMR, to UL Standard 444
- Superflexible corrugated outer conductor for flexibility and 100% shielding
- Broadband Performance up to 6.0 GHz
- Available with most popular connector interfaces  
including N, 7-16 DIN, 4.3-10.0, 4.1-9.5 DIN and SMA  
SPF-250 1/4" superflexible  
SPF-375 3/8" superflexible  
SPF-500 1/2" superflexible





# TFT™ Low PIM Coaxial Cables

ISO 9001 Certified

## Flexible, Low PIM, Plenum Rated Jumper Cable Assemblies

- -160 dBc PIM for optimal system performance
- UL listed, type CMP (plenum)  
UL file #E-170516
- Flat Braid outer conductor construction for optimal flexibility
- Durable FEP outer jacket is suitable for both indoor and outdoor use

**Major  
Carrier  
Approved!**



### TFT-401 (0.265") & TFT-402 (0.160") 50 Ohm low PIM cable assemblies

- Available in any required connector configuration and length
- Large selection of standard configurations for quick delivery
- Check inventory at [StockCheck](#) on our website
- Available connector interfaces: SMA, N, 7-16 DIN, 4.1/9.5, 4.3/10.0 mini DIN
- 100% tested for static and dynamic PIM, VSWR and insertion loss
- Marker band includes Serial Number PIM, VSWR & IL test data which is retained and accessible on the Times website
- 10 year warranty

Typical VSWR

[TFT401NMNM5.0M](#)

Dynamic PIM Test Results

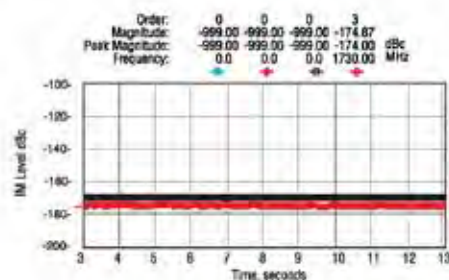

# TFT™ Low PIM Coaxial Cables



### Cable Construction

**Center Conductor:** Silver plated copper  
**Dielectric:** Taped PTFE  
**Shield:** Silver plated flat braid  
**Outer Braid:** Silver plated copper  
**Jacket:** Blue FEP

### Connectors

Low PIM connectors are available with interfaces of N, SMA, 7-16 DIN, 4.1/9.5 mini DIN and 4.3/10.0 mini DIN. Please consult Times Microwave Systems with your requirements.

### Cable Assemblies

TFT™ cable assemblies of standard configuration are available in stock, and are factory tested for dynamic and static PIM, IL and VSWR. In addition, Times Microwave Systems also provides customized TFT™ cable assemblies according to the special requirements.

- Jumpers available in any length with most popular connector combinations.
- iBwave VEX files available at [www.iBwave.com](http://www.iBwave.com)

Physical Specifications		TFT-401		TFT-402			
AA Drawing Number:		AA-11410		AA-11408			
Dimensions:		in	(mm)	in	(mm)		
Center Conductor:		0.0641	1.628	0.037	0.93		
Dielectric:		0.208	5.28	0.113	2.87		
Shield:		0.218	5.53	0.121	3.07		
Outer Braid:		0.240	6.09	0.138	3.51		
Jacket:		0.265	6.73	0.160	4.06		
Mechanical Specifications							
Bend Radius:		1.25	31.75	0.750	19.05		
Weight:		78 lbs/1000 ft		31 lbs/1000 ft			
Operating Temperature Range °C/°F		-55 to +150° C		-55 to +150° C			
Electrical Specifications							
Velocity of Propagation: %		72%		76%			
Impedance, Ohms		50 Ohms		50 Ohms			
Capacitance: pF/ft (pF/m)		28.2 pF/ft		26.7 pF/ft			
Shielding Effectiveness: dB		-80 dB		-80 dB			
Nominal Attenuation: dB/100 ft (100m) (Power kW)							
	450 MHz	4.8	(15.8)	0.95	7.4	(24.2)	0.45
	700 MHz	6.1	(22.2)	0.75	9.2	(30.3)	0.36
	850 MHz	6.8	(22.2)	0.66	10.2	(33.5)	0.33
	1900 MHz	10.5	(34.4)	0.44	15.4	(50.4)	0.22
	2100 MHz	11.1	(36.3)	0.41	16.2	(53.1)	0.21
	2300 MHz	11.8	(38.2)	0.39	16.9	(55.6)	0.20
	2400 MHz	11.9	(39.1)	0.38	17.3	(56.8)	0.19
	4900 MHz	17.9	(58.7)	0.25	25.0	(82.1)	0.13
	5800 MHz	19.7	(64.7)	0.25	27.3	(89.6)	0.12
N Male Straight		TC-TFT401-NM-LP (3190-2943BLK)		TC-TFT402-NM-LP (3190-2943BLK)			
N Male Right Angle		TC-TFT401-NM-RA-LP (3190-3057BLK)		TC-TFT402-NM-RA-LP (3190-3015BLK)			
N Female		TC-TFT401-NF-LP (3190-3060BLK)		TC-TFT402-NF-LP (3190-3004BLK)			
N Female Bulkhead				TC-TFT402-NF-BH-LP (3190-3013BLK)			
7-16 DIN Male Straight		TC-TFT401-716M-LP (3190-2944BLK)		TC-TFT402-716M-LP (3190-2942BLK)			
7-16 DIN Male Right Angle		TC-TFT401-716M-RA-LP (3190-3058BLK)		TC-TFT402-716M-RA-LP (3190-2967BLK)			
7-16 DIN Female Straight				TC-TFT402-716F-LP (3190-3003BLK)			
SMA Male Straight		TC-TFT401-SM-LP (3190-2941BLK)		TC-TFT402-SM-LP (3190-2903BLK)			
SMA Male Right Angle		TC-TFT401-SM-RA-LP (3190-3059BLK)		TC-TFT402-SM-RA-LP (3190-3059BLK)			
4.1/9.5 mini DIN Male Straight		TC-TFT401-4195M-LP (3190-3008BLK)		TC-TFT402-4195M-LP (3190-3009BLK)			
4.1/9.5 mini DIN Male Right Angle		TC-TFT401-4195M-RA-LP (3190-6127BLK)					
4.1/9.5 mini DIN Female		TC-TFT401-4195M-F-LP (3190-6126BLK)		TC-TFT402-4195F-LP (3190-6184BLK)			
4.3/10.0 DIN Male Straight		TC-TFT401-4310M-LP (3190-6171BLK)		TC-TFT402-4310M-LP (3190-6125BLK)			
4.3/10.0 DIN Male Right Angle		TC-TFT401-4310M-RS-LP (3190-6172BLK)		TC-TFT402-4310M-RA-LP (3190-6173BLK)			
4.1/9.5 mini DIN Female Bulkhead				TC-TFT402-4310F-LP (3190-6195)			
4.1/9.5 mini DIN Female Bulkhead				TC-TFT402-4310F-BH-LP (3190-6196BLK)			

# TFT™ Low PIM Coaxial Cables

## Smart Part Number Key for TFT Low PIM Jumpers

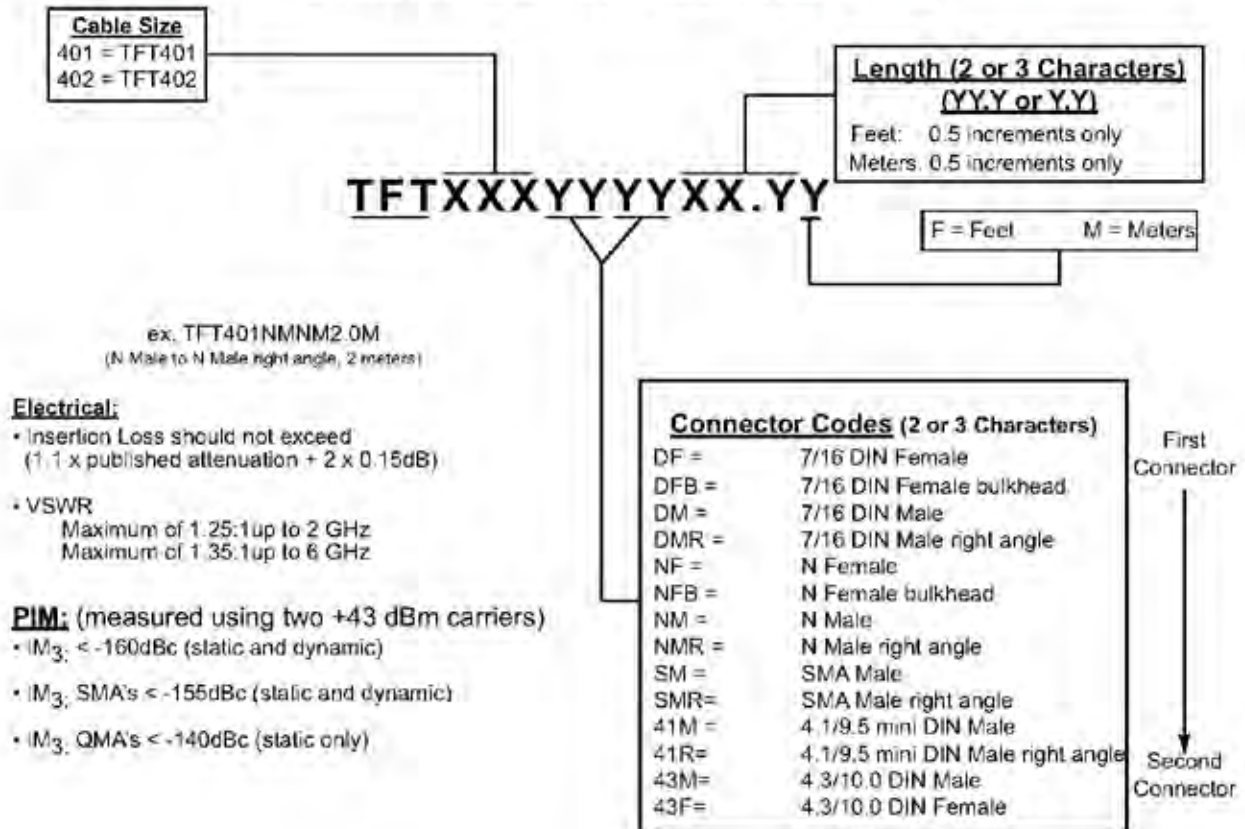

*Many assembly configurations are available from stock.  
Refer to the on-line [StockCheck](#) for specific configurations.*

Ultraflexible, PIM rated, Plenum rated - TFT Jumpers are the ideal DAS interconnect solution

- PIM, VSWR and Insertion Loss Test  
Results marked on each jumper
- Better than -160 dBc PIM Static and Dynamic
- UL/CSA Plenum Listed and Printed with Reference File #E-170516, Type CMP, to UL Standard 444
- Ultraflexible outer conductor for flexibility and 100% shielding
- Broadband Performance up to 6.0 GHz
- Available with most popular connector interfaces including N, 7-16 DIN, 4.3-10.0, 4.1-9.5 DIN and SMA  
TFT-401 (0.265") ultraflexible  
TFT-402 (0.160") ultraflexible



# TFT-LF™ Low PIM Coaxial Cables

ISO 9001 Certified

*Flexible, Low PIM, Plenum Rated  
Jumper Cable Assemblies*

- *-160 dBc PIM for optimal system performance*
- *UL listed, type CMP (plenum)  
UL file #E-170516*
- *Flat braid outer conductor construction for optimal flexibility*
- *Durable FEP outer jacket is suitable for both indoor and outdoor use*

**Major  
Carrier  
Approved!**



*TFT-401-LF (0.265") & TFT-402-LF (0.160") 50 Ohm low PIM cable assemblies*

- Available in any required connector configuration and length
- Large selection of standard configurations for quick delivery
- Check inventory at [StockCheck](#) on our website
- Available connector interfaces: SMA, N, 7-16 DIN, 4.1/9.5, 4.3/10.0 mini DIN
- 100% tested for static and dynamic PIM, VSWR and insertion loss
- Serial marker band includes PIM, VSWR & IL test data which is retained and accessible on the Times website
- 10 year Times Microwave warranty

Typical VSWR

TFT401NMM5.0M

Dynamic PIM Test Results

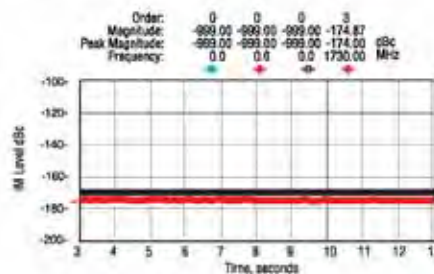

# TFT-LF™ Low PIM Coaxial Cables



### Cable Construction

**Center Conductor:** Bare copper  
**Dielectric:** Taped PTFE  
**Shield:** Tin plated flat braid  
**Outer Braid:** Tin plated copper  
**Jacket:** Blue FFP

### Connectors

Low PIM connectors are available with interfaces of N, SMA, 7-16 DIN, 4.1/9.5 mini DIN and 4.3/10.0 mini DIN. Please consult Times Microwave Systems with your requirements.

### Cable Assemblies

TFT™ cable assemblies of standard configuration are available in stock, and are factory tested for dynamic and static PIM, IL, and VSWR. In addition, Times Microwave Systems also provides customized TFT™ cable assemblies according to the special requirements.

- Jumpers available in any length with most popular connector combinations.

Physical Specifications		TFT-401-LF	TFT-402-LF
AA Drawing Number:		AA-11432	AA-11431
Dimensions:		in (mm)	in (mm)
Center Conductor:		0.0541 1.628	0.037 0.93
Dielectric:		0.208 5.28	0.113 2.87
Shield:		0.218 5.53	0.121 3.07
Outer Braid:		0.240 6.09	0.136 3.51
Jacket:		0.265 6.73	0.160 4.06
Mechanical Specifications			
Bend Radius:		1.25 31.75	0.750 19.05
Weight:		78 lbs/1000 ft	31 lbs/1000 ft
Operating Temperature Range °C/°F		-55 to +150° C	-55 to +150° C
Electrical Specifications			
Velocity of Propagation: %		72%	76%
Impedance: Ohms		50 Ohms	50 Ohms
Capacitance: pF/ft (pF/m)		28.2 p/ft	26.7 p/ft
Shielding Effectiveness: dB		-80 dB	-80 dB
Nominal Attenuation: dB/100 ft (100m) (Power kW)			
450 MHz	5.1 (16.7)	0.91	7.9 (25.8) 0.49
700 MHz	6.5 (21.5)	0.70	9.8 (32.3) 0.34
850 MHz	7.3 (24.0)	0.63	10.9 (35.7) 0.31
1900 MHz	11.9 (36.9)	0.38	16.4 (54.0) 0.20
2100 MHz	12.6 (41.4)	0.36	17.3 (56.8) 0.19
2300 MHz	13.4 (43.9)	0.34	18.2 (59.0) 0.18
2400 MHz	13.7 (45.0)	0.33	18.6 (60.9) 0.18
3900 MHz	21.8 (71.4)	0.21	27.0 (88.4) 0.12
5800 MHz	24.4 (80.0)	0.18	29.5 (96.7) 0.11
N Male Straight	TC-TFT401-NM-LP (3190-2943BLK)		TC-TFT402-NM-LP (3190-2943BLK)
N Male Right Angle	TC-TFT401-NM-RA-LP (3190-3057BLK)		TC-TFT402-NM-RA-LP (3190-3015BLK)
N Female	TC-TFT401-NF-LP (3190-3060BLK)		TC-TFT402-NF-LP (3190-3004BLK)
N Female Bulkhead			TC-TFT402-NF-BH-LP (3190-3013BLK)
7-16 DIN Male Straight	TC-TFT401-716M-LP (3190-2944BLK)		TC-TFT402-716M-LP (3190-2942BLK)
7-16 DIN Male Right Angle	TC-TFT401-716M-RA-LP (3190-3058BLK)		TC-TFT402-716M-RA-LP (3190-2967BLK)
7-16 DIN Female Straight			TC-TFT402-716F-LP (3190-3003BLK)
SMA Male Straight	TC-TFT401SM-LP (3190-2941BLK)		TC-TFT402-SM-LP (3190-2903BLK)
SMA Male Right Angle	TC-TFT401-SM-RA-LP (3190-3059BLK)		TC-TFT402SM-RA-LP (3190-3058BLK)
4.1/9.5 mini DIN Male Straight	TC-TFT401-4195M-LP (3190-3008BLK)		TC-TFT402-4195M-LP (3190-3009BLK)
4.1/9.5 mini DIN Male Right Angle	TC-TFT401-4195M-RA-LP (3190-6127BLK)		
4.1/9.5 mini DIN Female	TC-TFT401-4195MF-LP (3190-6126BLK)		TC-TFT402-4195F-LP (3190-6184BLK)
4.3/10.0 DIN Male Straight	TC-TFT401-4310M-LP (3190-6171BLK)		TC-TFT402-4310M-LP (3190-6125BLK)
4.3/10.0 DIN Male Right Angle	TC-TFT401-4310M-RS-LP (3190-6172BLK)		TC-TFT402-4310M-RA-LP (3190-6173BLK)
4.1/9.5 mini DIN Female			TC-TFT402-4310F-LP (3190-6195)
4.1/9.5 mini DIN Female Bulkhead			TC-TFT402-4310F-BH-LP (3190-6196BLK)

TFT-LF™ products are included in the iBwave In-Building Network Components Database at [iBwave.com](http://iBwave.com)

# TFT-LF™ Low PIM Coaxial Cables

## Smart Part Number Key for TFT-LF Low PIM Jumpers

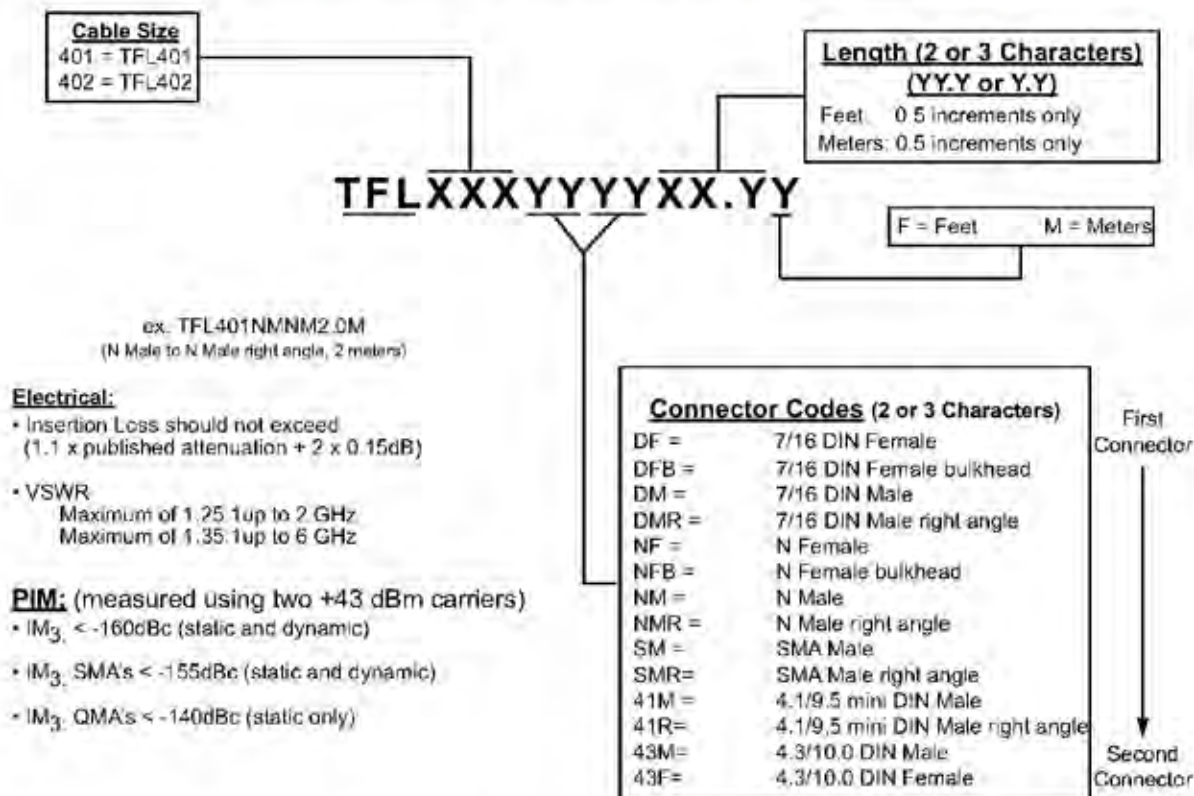

*Many assembly configurations are available from stock.*

Ultraflexible, PIM rated, Plenum rated – TFT-LF Jumpers are the ideal DAS interconnect solution

- PIM, VSWR and Insertion Loss Test  
Results marked on each jumper
- Better than -160 dBc PIM Static and Dynamic
- UL/CSA Plenum Listed and Printed with Reference File #E-170516, Type CMP, to UL Standard 444
- Ultraflexible outer conductor for flexibility and 100% shielding
- Broadband Performance up to 6.0 GHz
- Available with most popular connector interfaces including N, 7-16 DIN, 4.3-10.0, 4.1-9.5 DIN and SMA  
TFT-LF-401 (0.265") ultraflexible  
TFT-LF-402 (0.160") ultraflexible





**Engineered Products:**  
**Bundled Cables**

High quality LMR® Low Loss flexible 50 Ohm coax feeder cable, bundled under a common outer jacket for multiple run applications

- Smart antenna feeders
- IF & RF runs to tower mounted amplifiers for cellular, point to point, broadcast wireless or WiMax systems

• **LMR® Bundled Cable** is a spiral configuration of multiple LMR-400 or smaller LMR cables under a common polyethylene outer jacket. This innovative design acts as the perfect feeder cable for applications requiring multiple runs, such as on towers or building top sites. A unique, patented grounding fixture grounds the outer shields of each cable and a rugged end cap seals the bundle to prevent moisture ingress at the break-out point.

• **LMR Bundled Cable** can be supplied as a complete assembly with break outs and connectors on both ends, as a single ended assembly with pull hoist (base can be trimmed and terminated after installation on tower), or as raw cable and accessories along with easy to use tools. Pictorial instructions and videos are available to assist in the installation of the accessories.



• **Features and Benefits:**

- Less cable runs
- Fewer ground kits
- Significantly less cable clamps to install
- Reduced labor and material costs
- Rip cord for easy removal of outer jacket
- Inner cables labeled with an identifier every six inches
- Less wind load
- Greater system reliability
- Professional appearance
- Standard cables include:
  - LMR-BC240-4
  - LMR-BC240-9
  - LMR-BC240-9-LW-75
  - LMR-BC240-12
  - LMR-BC300-12
  - LMR-BC400-7
  - LMR-BC400-9
  - LMR-BC400-9-DB

Consult factory for other or custom configurations.

Frequency (MHz)	Attenuation dB/100 ft				
	150	450	900	2000	2500
LMR-BC240-4	3	5.4	7.7	11.7	13.1
LMR-BC240-9	3	5.4	7.7	11.7	13.1
LMR-BC240-9-LW-75	3	5.4	7.7	11.7	13.1
LMR-BC240-12	3	5.4	7.7	11.7	13.1
LMR-BC300-12	2.4	4.3	6.2	9.4	10.6
LMR-BC400-7	1.5	2.8	4	6.2	7
LMR-BC400-9	1.5	2.8	4	6.2	7
LMR-BC400-9-DB	1.5	2.8	4	6.2	7

Part Number (Stock Code)	LMR-BC240-4 (31845)	LMR-BC240-9 (31844)
Components	LMR-240	LMR-240
Bundle Configuration	F-4	1-8
Outer Protection	PE Jacket	PE Jacket
Overall Diameter (in)	0.688	1.06
Weight (lbs/ft)	0.195	0.375
Bend Radius (in)	7	11
Temperature Range		
Impedance		

## Install Tools

The LMR bundled cable tool package contains a number of unique products designed for easy use and long life. The ST-BC-1 and ST-BC-2 make up a universal outer sheath removal tool set that can be used with any of our bundled cables. Custom sheath removal tools are available for the LMR-BC240-12, LMR-BC300-12 and the LMR-BC400-9. (See table on page 241)

The GST-240A, 300A and 400A inner cable jacket removal tools can easily accomplish the otherwise challenging task of removing the outer jacket from the internal LMR-240, 300 and 400 cables.



**GST-BC Series:**  
Custom designed to quickly remove the outer sheath of the LMR bundled cable.



**ST-BC-2:**  
Can be used in combination with the ST-BC-1 to remove the outer sheath of a bundled cable for grounding or fan out.



**ST-BC-1:**  
Can be used in combination with the ST-BC-2 to remove the outer sheath of a bundled cable for grounding or fan out.



**GST-240A, GST-300A, GST-400A:**  
Custom designed to quickly remove the outer jacket of the individual internal cables of LMR-240, 300 and 400 based cables.

### Bundled Cable Specifications

LMR-BC240-9-LW-75 (31846)	LMR-BC240-12 (31842)	LMR-BC300-12 (31843)	LMR-BC400-7 (31836)	LMR-BC400-9 (31831)	LMR-BC400-9-DB (31838)
LMR-LW-240-75	LMR-240	LMR-300	LMR-400	LMR-400	LMR-400-DB
1-8	4-8	4-8	1-6	1-8	1-8
PE Jacket	PE Jacket	PE Jacket	PE Jacket	PE Jacket	PE Jacket
1.06	1.2	1.475	1.35	1.6	1.6
0.295	0.58	0.89	0.63	0.75	0.75
11	13	15	14	16	16
-40°F to + 185°F (-40° C to + 85° C)					
50 Ohms					

**Engineered Products:**  
**Bundled Cables**

**Grounding Kit**

All outdoor antenna feeder runs should be grounded at their lowest point just prior to entering the base station or radio enclosure. Depending on the height of the tower run, additional ground points may be required (see table below)

Tower Height (TH)	Location of Additional Grounds*	Comments
<30 meters	No additional GKs required	
30-59 meters	TH/2	1 additional GK
60-69 meters	TH/3 and (TH/3)(2)	2 additional GKs

\* These locations are referenced from the base of the tower  
Times Microwave Systems has developed a unique, patented grounding fixture that is both economical and easy to install. This ground fixture effectively grounds all the individual cables in the bundle, while requiring only one bonding cable per fixture to be fastened to the tower.

**Grounding**

1) The outer conductors of individual cables must be grounded/bonded to an adequate ground.

2) All installations regardless of tower height (TH) should be grounded just prior to entering the equipment building or shelter. The cable should also be grounded at the tower base. The ground at the tower base and just prior to building entry should be as close to the ground plane as possible.

3) For towers greater than 30 meters high, additional grounding is required.



GK-BC-400-9



**End Cap Kit**



Times Microwave Systems offers weather seal break out End Caps for a number of the LMR bundled cables. These kits consist of a hard ABS plastic split shell with stainless steel screws, a silicone rubber split cushion and a silicone rubber gasket. The split cushion is formed over the inner cables and the shell is then positioned over the transition so that the end of the outer jacket of the cable is roughly in the middle of the shell. (see the bundled cable End Cap pictorial instructions at [www.timesmicrowave.com](http://www.timesmicrowave.com))



# Weather Seal Kit



It is important that the ground kit be properly weather sealed. This bundled cable process provides labor savings and increased reliability. Composed of six rolls of Butyl Rubber tape and three rolls of black polyvinyl tape, the WK-U Weather Seal Kit provides everything necessary to properly seal one installed ground fixture.

## Tools and Install Accessories

Type	Part Number	Description
Bundle Jacket Strip Tool	ST-BC-1 & ST-BC-2	Bundled jacket strip tool for cables not having a custom jacket removal tool
	GST-BC240-12	Bundled jacket strip tool for LMR-BC240-12
	GST-BC300-12	Bundled jacket strip tool for LMR-BC300-12
	GST-1700	Bundled jacket strip tool for LMR-BC400-9
Individual Coax Strip Tool	GST-240A	Individual coax strip tool for LMR-240 based cables
	GST-300A	Individual coax strip tool for LMR-300 based cables
	GST-400A	Individual coax strip tool for LMR-400 based cables
GK-BC-400-9B	GK-BC400-9	Bundle Ground Kit for BC-400-9
EC-BC400-4-CS	EC-BC400-4-CS	Breakout Weatherseal Boot for BC-400-4
EC-BC400-7B	EC-BC400-7B	Breakout Weatherseal Boot for BC-400-7
EC-BC400-9B	EC-BC400-9B	Breakout Weatherseal Boot for BC-400-9
EC-BC240-12B	EC-BC400-12B	Breakout Weatherseal Boot for BC-240-12
Hangers	1/2" cable hanger	Hangers for LMR-BC240-4
	7/8" cable hanger	Hangers for LMR-BC240-9
	7/8" cable hanger	Hangers for LMR-BC240-9 LW-75
	SH-U1200T	Hangers for LMR-BC240-12
	1 1/4" cable hanger	Hangers for LMR-BC300-12
	1 1/4" cable hanger	Hangers for LMR-BC400-7
	SH-U1700T	Hangers for LMR-BC400-9
	SH-U1700T	Hangers for LMR-BC400-9-DB
	Hoisting Grips	1/2" cable hoist
7/8" cable hoist		Hoisting grips for LMR-BC240-9
7/8" cable hoist		Hoisting grips for LMR-BC240-9-LW-75
HG-1200T		Hoisting grips for LMR-BC240-12
1 1/4" cable hoist		Hoisting grips for LMR-BC300-12
1 1/4" cable hoist		Hoisting grips for LMR-BC400-7
HG-1700T		Hoisting grips for LMR-BC400-9
HG-1700T		Hoisting grips for LMR-BC400-9-DB

## Times Protect

### LP-BTR Series

- DC Blocked for Maximum Surge Protection
- Multi-Strike Capability
- Broadband Performance from 20MHz up to 1000MHz
- Exceptional RF Characteristics
- Solid Brass Construction for Durability and Long Life
- Universal Grounding Bracket for Flange or Bulkhead Installations



ISO 9001 Certified



### Lightning and Surge Protection for The 21st Century™

The **Times Protect**® LP-BTR high performance surge arrester series addresses applications in the 20MHz-1000MHz spectrum. Our unique DC blocking technology employed in this design provides optimum isolation of the antenna port from the protected equipment port for maximum surge protection. LP-BTR surge protectors have exceptional RF performance and are constructed from the highest quality materials for unsurpassed durability and longevity. These units meet and surpass all applicable industry standards.

The LP-BTR product family is available with N connector configurations to satisfy various installation requirements.

#### LP-BTR Series:

- LP-BTR-NFF  
N Female connectors on surge and protected sides
- LP-BTR-NMP  
N Male connector on protected side with N Female connector on surge side
- LP-BTR-NMS  
N Male connector on surge side with N Female connector on protected side

# Times-Protect®

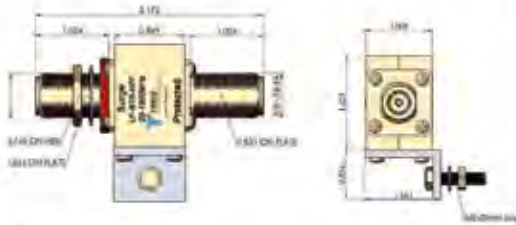

• LP-BTR-NFF  
20-1000MHz DC Blocked N Type F/F

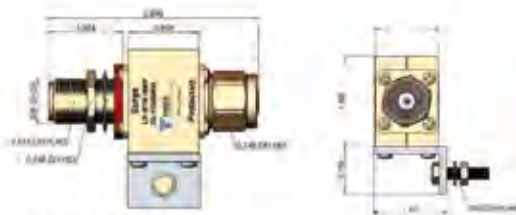

• LP-BTR-NMP  
20-1000MHz DC Blocked N Type M on Protected

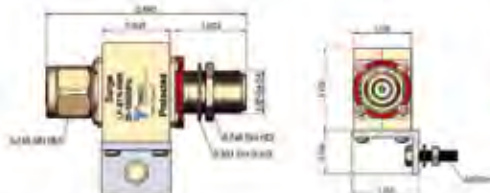

• LP-BTR-NMS  
20-1000MHz DC Blocked N Type M on Surge

\*All dimensions shown in inches

Electrical Specifications		
Impedance	50 Ω	
Frequency Range	20-1000 MHz	
VSWR/Return Loss	<1.1:1 / <-26dB	
Insertion Loss	< 0.1dB	
Impulse Discharge Current	10KA multiple (8x20μs wave-form)	
Turn-on Voltage	600V ± 20%	
Turn-on Time	2.5ns for 2kV/ns	
Energy Throughput Rating	<200μJ (4kV/2kA 1.2x50/8x20μs wave-form)	
Power Handling at Frequency	375W (20-220MHz) 125W (220-700MHz) 50W (700-1000MHz)	
Protection Circuit	DC Blocked	
Mechanical / Environmental Specifications		
Temp Range Storage/Operating	-40°C - +85°C / -40°C - +50°C	
Weatherization	Required for external use	
Thermal Shock	US MIL-STD 202, Meth.107,Cond.B	
Vibration	US MIL-STD 202, Meth.204,Cond.B	
Shock	US MIL-STD 202, Meth.213,Cond.I	
RoHS Compliant	Yes	
Mating Life Cycle	> 500	
Recommended Coupling Nut Torque	7 to 10 lb-in	
Unit Weight	0.25kg/pc / 0.55lb	
Material Specifications		
Component	Material	Plating
Body	Brass	White Bronze
Inner Conductor Male	Brass	Silver
Inner Conductor Female	Phosphor Bronze	Silver
Outer Conductor	Brass	White Bronze
Coupling Nut	Brass	White Bronze
Insulator	PTFE	--

## Times Protect<sup>®</sup>

### LP-BTRW Series

- IP67 Weatherized for Outdoor Use
- DC Blocked for Maximum Surge Protection
- Multi-Strike Capability
- Broadband Performance From 20MHz up to 1000MHz
- Exceptional RF Characteristics
- Solid Brass White Bronze Plated Construction for Durability and Long Life
- Universal Grounding Bracket Supplied



IP67  
Weatherized!



ISO 9001 Certified

### Lightning and Surge Protection for The 21st Century™

The Times Protect™ LP-BTRW high performance surge arrestor series addresses applications in the 20MHz-1000MHz spectrum. Our unique DC blocking technology employed in this design provides optimum isolation of the antenna port from the protected equipment port for maximum surge protection.

LP-BTRW surge protectors have exceptional RF performance and are constructed from the highest quality materials for unsurpassed durability and longevity. These units meet and surpass all applicable industry standards.

The LP-BTRW product family is available with N connector configurations and fully weatherized to the IP67 standard for outdoor use.

#### LP-BTRW Series:

- LP-BTRW-NFF  
N Female connectors on surge and protected sides
- LP-BTRW-NMP  
N Male connector on protected side with N Female connector on surge side
- LP-BTRW-NMS  
N Male connector on surge side with N Female connector on protected side

# Times-Protect™



- LP-BTRW-NFF  
20-1000MHz DC Blocked N Type F/F



- LP-BTRW-NMP  
20-1000MHz DC Blocked N Type M on Protected



- LP-BTRW-NMS  
20-1000MHz DC Blocked N Type M on Surge

\*All dimensions shown in inches

Electrical Specifications	
Impedance	50 Ω
Frequency Range	20-1000 MHz
VSWR/Return Loss	<1.1:1 / <-26dB
Insertion Loss	< 0.1dB
Impulse Discharge Current	10KA multiple (8x20μs wave-form)
Turn-on Voltage	600V ± 20%
Turn-on Time	2.5ns for 2kV/ns
Energy Throughput Rating	<200μJ (5kV/3kA 1.2x50/3x20μs wave-form)
Power Handling at Frequency	375W (20-220MHz) 125W (220-700MHz) 50W (700-1000MHz)
Protection Circuit	DC Blocked

Mechanical / Environmental Specifications	
Temp Range Storage/Operating	-40°C - +85°C / -40°C - +50°C
Weatherization	IEC 60068 55/155/56 & IP67
Thermal Shock	US MIL-STD 202, Meth.107,Cond.B
Vibration	US MIL-STD 202, Meth.204,Cond.B
Shock	US MIL-STD 202, Meth.213,Cond.I
RoHS Compliant	Yes
Mating Life Cycle	> 500
Recommended Coupling Nut Torque	7 to 10 in-lb
Unit Weight	0.25kg/pc / 0.55lb

Material Specifications		
Component	Material	Plating
Body	Brass	White Bronze
Inner Conductor Male	Brass	Silver
Inner Conductor Female	Phosphor Bronze	Silver
Outer Conductor	Brass	White Bronze
Coupling Nut	Brass	White Bronze
Insulator	PTFE	--





# Times Protect<sup>®</sup>

## LP-GTR-D Series

- DC Pass Multi-Strike Design
- Replaceable Gas Tube
- Broadband Bidirectional Design
- Excellent IL/RL Performance Over the Entire Operating Frequency Band
- Fully Weatherized Housing
- Solid Brass Construction for Durability and Long Life
- Includes Universal Right Angle Bracket Adaptor



ISO 9001 Certified



## Lightning and Surge Protection for The 21st Century™

The Times-Protect<sup>®</sup> LP-GTR-D series is an exceptional broadband DC pass design for lightning protection applications requiring DC power to be supplied to the electronics. Offering outstanding surge performance the LP-GTR-D series is the perfect protection solution for distributed antenna systems, tower mounted amplifiers, GPS systems and other applications requiring DC pass circuitry. These devices exhibit outstanding RF performance with high surge current handling characteristics and cover a broad range of power handling requirements from 50 to 550 watts. Its fully weatherized housing meeting IP67 standard allows for outdoor as well as indoor installation. The 716 DIN connector types can be used from DC through 2500MHz.

### LP-GTR-D Series:

- LP-GTR-DFF (90Vdc/50W)
- LP-GTR-DFF-23 (230Vdc/210W)
- LP-GTR-DFF-35 (350Vdc/550W)  
716 DIN Female connectors on both sides - bidirectional
- LP-GTR-DFM (90Vdc/50W)
- LP-GTR-DFM-23 (230Vdc/210W)
- LP-GTR-DFM-35 (350Vdc/550W)  
716 DIN Male connector on one side & 716 DIN Female connector on the other side - bidirectional

# Times-Protect®



- LP-GTR-DFF
  - LP-GTR-DFF-23
  - LP-GTR-DFF-35
- DC Pass DIN Type F/F

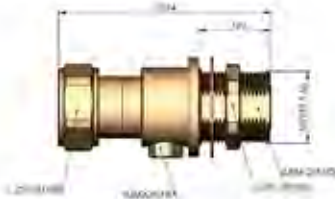

- LP-GTR-DFM
  - LP-GTR-DFM-23
  - LP-GTR-DFM-35
- DC Pass DIN Type F/M

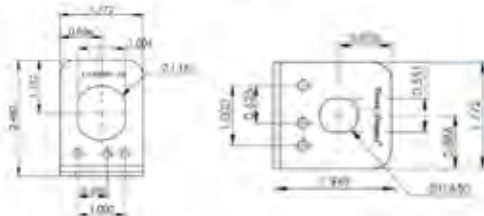

- Universal Right Angle Bracket Adaptor

\*All dimensions shown in inches

**Electrical Specifications**

Impedance	50 Ω		
Frequency Range	DC-2500 MHz		
VSWR/Return Loss	< 1.08:1 / < -28dB (DC to 1000MHz) < 1.1:1 / < -26dB (1000 to 2500MHz)		
Insertion Loss	< 0.1dB (DC-1000MHz) < 0.2dB (1000-2500MHz)		
Maximum Surge Current	20kA multiple (8x20µs wave-form)		
Part Number: LP-GTR-	DFF/DFM	DFF-23/DFM-23	DFF-35/DFM-35
Impulse Sparkover	500V (1kV/µs)	700V (1kV/µs)	800(1kV/µs)
Turn-on	90Vdc	230Vdc	350Vdc
Average Power	50 Watts	210 Watts	550 Watts
Protection Circuit	DC Pass		

**Mechanical / Environmental Specifications**

Temp Range Storage/Operating	-40°C - +85°C
Weatherization	IEC 60068 40/085/21 & IP 67
Thermal Shock	US MIL-STD 202, Meth.107,Cond.B
Vibration	US MIL-STD 202, Meth.204,Cond.B
Shock	US MIL-STD 202, Meth.213,Cond.I
RoHS Compliant	Yes
Wear/Mating Cycles	500 minimum
Recommended Coupling Nut Torque	220 to 300 lb-in
Unit Weight	0.4kg/pc \ 0.88lb

**Material Specifications**

Component	Material	Plating
Body	Brass	White Bronze
Inner Conductor Male	Brass	Silver
Inner Conductor Female	Phosphor Bronze	Silver
Washer	Brass	White Bronze
Coupling Nut	Brass	White Bronze
Insulator	TPX	--
O-Ring	Silicone Rubber	--

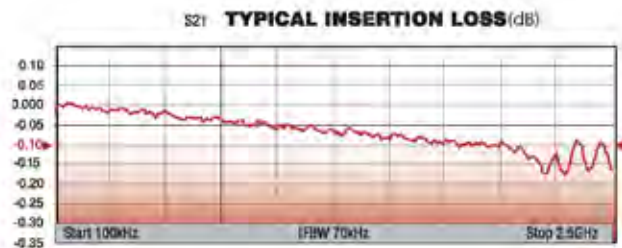

# TimesProtect<sup>®</sup>

## LP-GTR-N Series

- DC Pass Multi-Strike Design
- Replaceable Gas Tube
- Broadband Bidirectional Design
- Excellent IL/RL Performance Over the Entire Operating Frequency Band
- Fully Weatherized Housing
- Solid Brass Construction for Durability and Long Life
- Includes Universal Right Angle Bracket Adaptor



**TIMES MICROWAVE SYSTEMS**  
 An Amphenol Company

ISO 9001 Certified



## Lightning and Surge Protection for The 21st Century™

The TimesProtect<sup>®</sup> LP-GTR-N series is an exceptional broadband DC pass design for lightning protection applications requiring DC power to be supplied to the electronics. Offering outstanding surge performance, the LP-GTR-N series is the perfect protection solution for distributed antenna systems, tower mounted amplifiers, GPS systems and other applications requiring DC pass circuitry. These devices exhibit outstanding RF performance with high surge current handling characteristics and cover a broad range of power handling requirements from 50 to 550 watts. Its fully weatherized housing meeting IP67 standard allows for outdoor as well as indoor installation. The N connector designs cover the entire frequency spectrum from DC through 3000MHz.

### LP-GTR-N Series:

- LP-GTR-NFF (90Vdc/50W)
  - LP-GTR-NFF-23 (230Vdc/210W)
  - LP-GTR-NFF-35 (350Vdc/550W)
- N Female connectors on both sides - bidirectional
- LP-GTR-NFM (90Vdc/50W)
  - LP-GTR-NFM-23 (230Vdc/210W)
  - LP-GTR-NFM-35 (350Vdc/550W)
- N Male connector on one side & N Female connector on the other side - bidirectional

# Times-Protect®



- LP-GTR-NFF
  - LP-GTR-NFF-23
  - LP-GTR-NFF-35
- DC Pass N Type F/F



- LP-GTR-NFM
  - LP-GTR-NFM-23
  - LP-GTR-NFM-35
- DC Pass N Type F/M

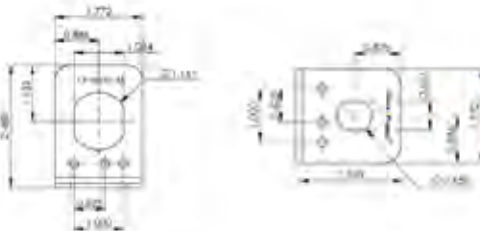

- Universal Right Angle Bracket Adaptor

\*All Dimensions shown in inches.

Electrical Specifications			
Impedance	50 Ω		
Frequency Range	DC-3000 MHz		
VSWR/Return Loss	< 1.1:1 / < -26dB (DC-2800MHz) < 1.13:1 / < -24dB (2800-3000MHz)		
Insertion Loss	< 0.1dB (DC-1000MHz) < 0.2dB (1000-3000MHz)		
Maximum Surge Current	20kA multiple (8x20µs wave-form)		
Part Number: LP-GTR	NFF/NFM	NFF-23/NFM-23	NFF-35/NFM-35
Impulse Sparkover	500V (1kV/µs)	700V (1kV/µs)	800V (1kV/µs)
Turn on	90Vdc	230Vdc	350Vdc
Average Power	50 Watts	210 Watts	550 Watts
Protection Circuit	DC Pass		
Mechanical / Environmental Specifications			
Temp Range Storage/Operating	-40°C - +85°C		
Weatherization	IEC 60068 40/085/21 & IP67		
Thermal Shock	US MIL-STD 202, Meth.107, Cond.B		
Vibration	US MIL-STD 202, Meth.204, Cond.B		
Shock	US MIL-STD 202, Meth.213, Cond.I		
RoHS Compliant	Yes		
Wear/Mating Cycles	500 minimum		
Recommended Coupling Nut Torque	7 to 10 lb-in		
Unit Weight	0.2kg/pc \ 0.44lb		
Material Specifications			
Component	Material	Plating	
Body	Brass	White Bronze	
Inner Conductor Male	Brass	Silver	
Inner Conductor	Phosphor Bronze	Silver	
Washer	Brass	White Bronze	
Coupling Nut	Brass	White Bronze	
Insulator	TPX	--	
O-Ring	Silicone Rubber	--	



# Times Protect<sup>®</sup>

## LP-STR-D Series

- DC Blocked for Superior Surge Protection
- Multi-Strike Capability
- High Power Rated
- High Surge Current Rating
- Outstanding IL/RL Characteristics
- Excellent PIM Performance
- Fully Weatherized Housing
- Solid Brass Construction for Durability and Long Life



**TIMES** MICROWAVE SYSTEMS  
 An Amphenol Company

ISO 9001 Certified



100% PIM Tested

## Lightning and Surge Protection for The 21st Century™

The Times Protect<sup>®</sup> LP-STR-D high performance series is an exceptional DC blocked design for outstanding surge performance. The operating bandwidth of 800MHz-2500MHz makes the LP-STR-D series suitable for a broad range of applications. With its excellent passive intermodulation performance, outstanding RF performance over the entire operating band and superior power handling capability, the LP-STR-D product family is unequaled. Its fully weatherized housing meeting IP67 standard allows for outdoor as well as indoor installation.

### LP-STR-D Series:

- LP-STR-DFF  
716 DIN Female connectors on surge and protected side
- LP-STR-DMP  
716 DIN Male connector on protected side with 716 DIN Female connector on surge side
- LP-STR-DMS  
716 DIN Male connector on surge side with 716 DIN Female connector on protected side

# Times-Protect®



- LP-STR-DFF  
800-2500MHz DC Blocked DIN Type F/F



- LP-STR-DMP  
800-2500MHz DC Blocked DIN Type M on Protected



- LP-STR-DMS  
800-2500MHz DC Blocked DIN Type M on Surge

\*All dimensions shown in inches.

Electrical Specifications	
Impedance	50 Ω
Frequency Range	800-2500 MHz
VSWR / Return Loss	<1 13:1 / <-24dB (800-840MHz) <1.1:1 / <-26dB (840-2500MHz)
Insertion Loss	< 0.1dB
Average Power	700 Watts
PIM	<-160 dBc
Maximum Surge Current	50kA (8/20µs wave-form)
Residual Pulse Voltage	< 100V (50kA 8/20µs wave-form)
Residual Pulse Voltage	< 1V (4kV/2kA 1.2x50/8x20µs wave-form)
Energy Throughput Rating	< 1nJ (4kV/2kA 1.2x50/8x20µs wave-form)
Protection Circuit	DC Blocked

Mechanical / Environmental Specifications	
Temp Range Storage/Operating	-40°C - +85°C
Weatherization	IEC 60068 55/155/56 & IP67
Thermal Shock	US MIL-STD 202, Meth.107,Cond.B
Vibration	US MIL-STD 202, Meth.204,Cond.B
Shock	US MIL-STD 202, Meth.213,Cond.I
RoHS Compliant	Yes
Mating Life Cycle	> 500
Recommended Coupling Nut Torque	220 to 300 lb-in
Unit Weight	0.6kg/pc      1.32lb

Material Specifications		
Component	Material	Plating
Body	Brass	White Bronze
Inner Conductor Male	Brass	Silver
Inner Conductor Female	Phosphor Bronze	Silver
Coupling Nut	Brass	White Bronze
Insulator	PTFE	--
O-Ring	Silicone Rubber	--

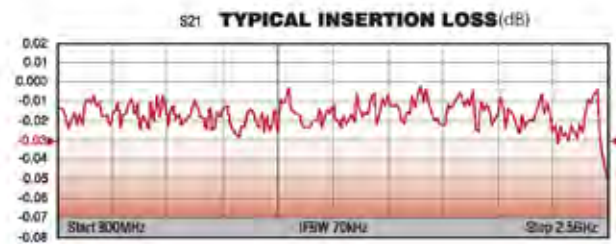

## Times Protect<sup>®</sup>

### LP-STR-N Series

- Excellent PIM Performance
- Outstanding IL/RL Characteristics
- DC Blocked for Superior Surge Performance
- High Surge Current Rating
- Broadband Multi-Strike Design
- High Power Rated
- Fully Weatherized Housing
- Solid Brass Construction for Durability and Long Life



ISO 9001 Certified



100% PIM Tested

### Lightning and Surge Protection for The 21st Century<sup>™</sup>

The Times Protect<sup>®</sup> LP-STR-N high performance series is an exceptional DC blocked design for superior surge performance, capable of withstanding multiple lightning strikes. The operating band width of 800MHz-2500MHz makes the LP-STR-N series suitable for a broad range of applications. With its excellent passive intermodulation performance, outstanding RF performance over the entire operating band and excellent power handling capability, the LP-STR-N product family is unequalled. Its fully weatherized housing meeting IP67 standard allows for outdoor as well as indoor installation.

#### LP-STR-N Series:

- LP-STR-NFF  
N Female connectors on surge and protected sides
- LP-STR-NMP  
N Male connector on protected side with N Female connector on surge side
- LP-STR-NMS  
N Male connector on surge side with N Female connector on protected side

# Times-Protect<sup>®</sup>



• LP-STR-NFF  
800-2500MHz DC Blocked N Type F/F



• LP-STR-NMP  
800-2500MHz DC Blocked N Type M on Protected



• LP-STR-NMS  
800-2500MHz DC Blocked N Type M on Surge

\*All dimensions shown in inches

### Electrical Specifications

Impedance	50 Ω
Frequency Range	800-2500 MHz
VSWR/Return Loss	< 1.13:1 / < -24dB (800-840MHz) < 1.1:1 / < -26dB (840-2500MHz)
Insertion Loss	< 0.1dB
Average Power	500 Watts
PIM	< -160 dBc
Maximum Surge Current	50kA (8x20µs wave-form)
Residual Pulse Voltage	< 100V (50kA 8x20µs wave-form)
Residual Pulse Voltage	< 1V (4kV/2kA 1.2x50/8x20µs wave-form)
Energy Throughput Rating	< 1nJ (4kV/2kA 1.2x50/8x20µs wave-form)
Protection Circuit	DC Blocked

### Mechanical / Environmental Specifications

Temp Range Storage/Operating	-40°C - +85°C
Weatherization	IEC 60068 55/155/56 & IP67
Thermal Shock	US MIL-STD 202, Meth.107,Cond.B
Vibration	US MIL-STD 202, Meth.204,Cond.B
Shock	US MIL-STD 202, Meth.213,Cond.I
RoHS Compliant	Yes
Wear/Mating Cycles	500 minimum
Recommended Coupling Nut Torque	7 to 10 in-lb
Unit Weight	0.53kg/pc      1.17lb

### Material Specifications

Component	Material	Plating
Body	Brass	White Bronze
Inner Conductor Male	Brass	Silver
Inner Conductor Female	Phosphor Bronze	Silver
Coupling Nut	Brass	White Bronze
Insulator	PTFE	--
O-Ring	Silicone Rubber	--

S11 TYPICAL RETURN LOSS (dB)

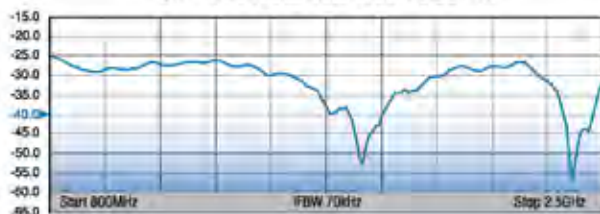

S21 TYPICAL INSERTION LOSS (dB)





# Times Protect®

## LP-STRL-D Series

- Long Term Evolution (LTE) and 700 MHz Public Safety Applications
- Excellent PIM Performance
- Outstanding IL/RL Characteristics
- DC Blocked for Superior Surge Performance
- High Surge Current/Power Rated
- Broadband Multi-Strike Design
- Fully Weatherized Housing
- Solid Brass Construction for Durability and Long Life



ISO 9001 Certified



100% PIM Tested

## Lightning and Surge Protection for The 21st Century™

The Times Protect® high performance series is an exceptional DC blocked design for outstanding surge performance, capable of withstanding multiple lightning strikes. The operating bandwidth of 680MHz-2200MHz makes the LP-STRL-D series suitable for a broad range of applications. This design covers the 700MHz Band for Public Safety Services as well as LTE (Long Term Evolution) applications. With its excellent passive intermodulation performance, outstanding RF performance over the entire operating band and superior power handling capability, the LP-STRL-D product family is unequalled. Its fully weatherized housing meeting IP67 standard allows for outdoor as well as indoor installation.

- LP-STRL-DFF  
716 DIN Female connectors on surge and protected side
- LP-STRL-DMP  
716 DIN Male connector on protected side with 716 DIN Female connector on surge side
- LP-STRL-DMS  
716 DIN Male connector on surge side with 716 DIN Female connector on protected side

# Times-Protect®

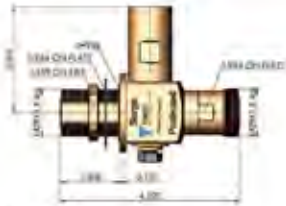

- LP-STRL-DFF  
680-2200MHz DC Blocked DIN Type F/F



- LP-STRL-DMP  
680-2200MHz DC Blocked DIN Type M on Protected



- LP-STRL-DMS  
680-2200MHz DC Blocked DIN Type M on Surge

\*All dimensions shown in inches

Electrical Specifications		
Impedance	50 Ω	
Frequency Range	680-2200 MHz	
VSWR / Return Loss	< 1.13:1 / < -24dB (680-700MHz) < 1.1:1 / < -26dB (700-2200MHz)	
Insertion Loss	< 0.1dB	
Average Power	700 Watts	
PIM	< -160 dBc	
Maximum Surge Current	50kA (8/20μs wave-form)	
Residual Pulse Voltage	< 100V (50kA 8/20μs wave-form)	
Residual Pulse Voltage	< 1V (4kV/2kA 1.2x50/8x20μs wave-form)	
Energy Throughput Rating	< 1nJ (4kV/2kA 1.2x50/8x20μs wave-form)	
Protection Circuit	DC Blocked	
Mechanical / Environmental Specifications		
Temp Range Storage/Operating	-40°C - +85°C	
Weatherization	IEC 60068 55/155/56 & IP67	
Thermal Shock	US MIL-STD 202, Meth.107, Cond.B	
Vibration	US MIL-STD 202, Meth.204, Cond.B	
Shock	US MIL-STD 202, Meth.213, Cond.I	
RoHS Compliant	Yes	
Mating Life Cycle	> 500	
Recommended Coupling Nut Torque	220 to 300 lb-in	
Unit Weight	0.6kg/pc \ 1.32lb	
Material Specifications		
Component	Material	Plating
Body	Brass	White Bronze
Inner Conductor Male	Brass	Silver
Inner Conductor	Phosphor Bronze	Silver
Coupling Nut	Brass	White Bronze
Insulator	PTFE	--
O-Ring	Silicone Rubber	--

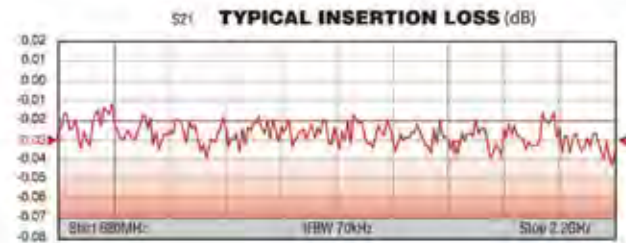
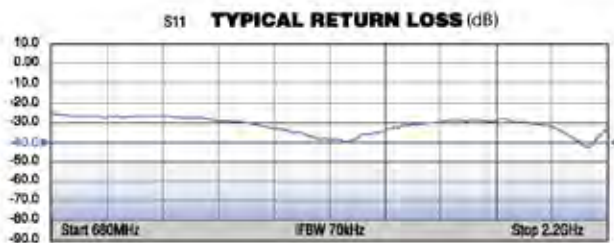

# Times Protect®

## LP-STRL-N Series

- Long Term Evolution (LTE) and 700 MHz Public Safety Applications
- Excellent PIM Performance
- Outstanding IL/RL Characteristics
- DC Blocked for Superior Surge Performance
- High Surge Current/Power Rated
- Broadband Multi-Strike Design
- Fully Weatherized Housing
- Solid Brass Construction for Durability and Long Life



ISO 9001 Certified



## Lightning and Surge Protection for The 21st Century™

The Times Protect® LP-STRL-N high performance series is an exceptional DC blocked design for outstanding surge performance, capable of withstanding multiple lightning strikes. The operating band width of 680MHz - 2200MHz makes the LP-STRL-N series suitable for a broad range of applications. This design covers the 700MHz Band for Public Safety Services as well as LTE (Long Term Evolution) applications. With its excellent passive intermodulation performance, outstanding RF performance over the entire operating band and superior power handling capability, the LP-STRL-N product family is unequalled. Its fully weatherized housing meeting IP67 standard allows for outdoor as well as indoor installation.

### LP-STRL-N Series:

- LP-STRL-NFF  
N Female connectors on surge and protected sides
- LP-STRL-NMP  
N Male connector on protected side with N Female connector on surge side
- LP-STRL-NMS  
N Male connector on surge side with N Female connector on protected side

# Times-Protect®

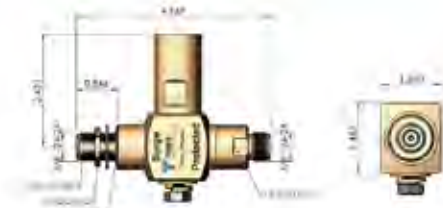

• LP-STRL-NFF  
680-2200MHz DC Blocked N Type F/F

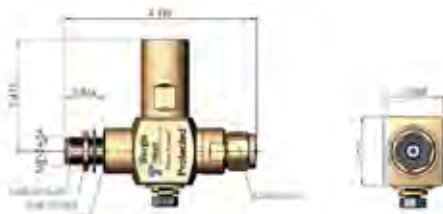

• LP-STRL-NMP  
680-2200MHz DC Blocked N Type M on Protected

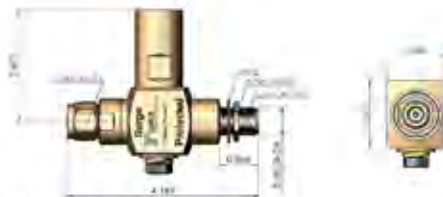

• LP-STRL-NMS  
680-2200MHz DC Blocked N Type M on Surge

\*All dimensions shown in inches

## Electrical Specifications

Impedance	50 Ω
Frequency Range	680-2200 MHz
VSWR/Return Loss	< 1.13:1 / <-24dB (680-700MHz) < 1.1:1 / <-26dB (700-2200MHz)
Insertion Loss	< 0.1dB
Average Power	500 Watts
PIM	<-160dBc
Maximum Surge Current	50kA (8x20µs wave-form)
Residual Pulse Voltage	< 100V (50kA 8x20µs wave-form)
Residual Pulse Voltage	< 1V (4kV/2kA 1.2x50/8x20µs wave-form)
Energy Throughput Rating	< 1nJ (4kV/2kA 1.2x50/8x20µs wave-form)
Protection Circuit	DC Blocked

## Mechanical / Environmental Specifications

Temp Range Storage/Operating	-40°C - +85°C
Weatherization	IEC 60068 55/155/56 & IP67
Thermal Shock	US MIL-STD 202, Meth.107, Cond.B
Vibration	US MIL-STD 202, Meth.204, Cond.B
Shock	US MIL-STD 202, Meth.213, Cond.I
RoHS Compliant	Yes
Wear/Mating Cycles	500 minimum
Recommended Coupling Nut Torque	7 to 10 in-lb
Unit Weight	0.53kg/pc / 1.17lb

## Material Specifications

Component	Material	Plating
Body	Brass	White Bronze
Inner Conductor Male	Brass	Silver
Inner Conductor Female	Phosphor Bronze	Silver
Coupling Nut	Brass	White Bronze
Insulator	PTFE	--
O-Ring	Silicone Rubber	--

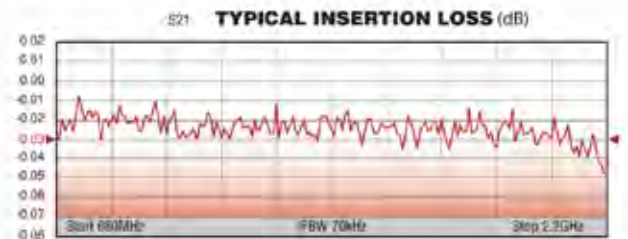

## Times Protect®

### LP-STRH-N Series

- Excellent PIM Performance
- Outstanding IL/RL Characteristics
- DC Blocked for Superior Surge Performance
- High Surge Current Rating
- Broadband Multi-Strike Design
- High Power Rated
- Fully Weatherized Housing
- Solid Brass Construction for Durability and Long Life



100% PIM  
Tested



ISO 9001 Certified

### Lightning and Surge Protection for The 21st Century™

The Times Protect® LP-STRH-N is an exceptional DC blocked design for superior surge performance, capable of withstanding multiple lightning strikes. The operating band width of 700MHz-2700MHz makes the LP-STRH-N suitable for a broad range of applications. With its excellent passive intermodulation performance, outstanding RF performance over the entire operating band and excellent power handling capability, the LP-STRH-N product is unequalled. Its fully weatherized housing meeting IP67 standard allows for outdoor as well as indoor installation.

#### LP-STRH-N Series:

- LP-STRH-NFF  
N Female connectors on surge and protected sides
- LP-STRH-NMP  
N Male connector on protected side with N Female connector on surge side
- LP-STRH-NMS  
N Male connector on surge side with N Female connector on protected side

# Times-Protect®



- LP-STRH-NFF  
700-2700MHz DC Blocked N Type F/F



- LP-STRH-NMP  
700-2700MHz DC Blocked N Type M on Protected



- LP-STRH-NMS  
700-2700MHz DC Blocked N Type M on Surge

\*All dimensions shown in inches

Electrical Specifications	
Impedance	50 Ω
Frequency Range	700-2700 MHz
VSWR/Return Loss	< 1.2:1 / <-24dB (700-840MHz) < 1.1:1 / <-26dB (840-2700MHz)
Insertion Loss	< 0.1dB
Average Power	500 Watts
PIM	<-160 dBc
Maximum Surge Current	50kA (8x20µs wave-form)
Residual Pulse Voltage	< 100V (50kA 8x20µs wave-form)
Residual Pulse Voltage	< 1V (4kV/2kA 1.2x50/8x20µs wave-form)
Energy Throughput Rating	< 1nJ (4kV/2kA 1.2x50/8x20µs wave-form)
Protection Circuit	DC Blocked

Mechanical / Environmental Specifications	
Temp Range Storage/Operating	-40°C - +85°C
Weatherization	IEC 60068 55/155/56 & IP67
Thermal Shock	US MIL-STD 202, Meth.107, Cond.B
Vibration	US MIL-STD 202, Meth.204, Cond.B
Shock	US MIL-STD 202, Meth.213, Cond.I
RoHS Compliant	Yes
Wear/Mating Cycles	500 minimum
Recommended Coupling Nut Torque	7 to 10 in-lb
Unit Weight	0.53kg/pc 1.17lb

Material Specifications		
Component	Material	Plating
Body	Brass	White Bronze
Inner Conductor Male	Brass	Silver
Inner Conductor Female	Phosphor Bronze	Silver
Coupling Nut	Brass	White Bronze
Insulator	PTFE	--
O-Ring	Silicone Rubber	--

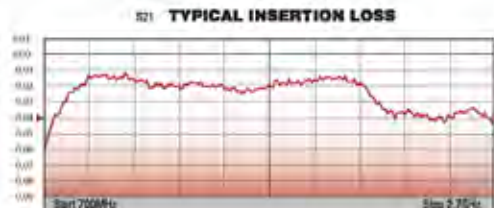
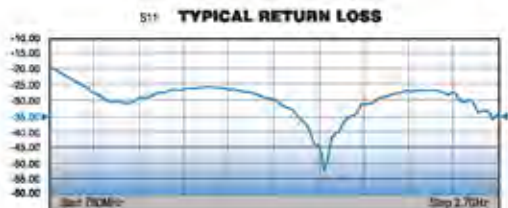

## Times Protect®

### LP-STRH-4.3-10 Series

- Excellent PIM Performance
- Outstanding IL/RL Characteristics
- DC Blocked for Superior Surge Performance
- High Surge Current Rating
- Broadband Multi-Strike Design
- High Power Rated
- Fully Weatherized Housing
- Solid Brass Construction for Durability and Long Life



100% PIM Tested



ISO 9001 Certified

### Lightning and Surge Protection for The 21st Century™

The Times Protect® LP-STRH-4.3-10 series is an exceptional DC blocked design for superior surge performance, capable of withstanding multiple lightning strikes. The operating band width of 700MHz-2700MHz makes the LP-STRH-4.3-10 suitable for a broad range of applications. With its excellent passive intermodulation performance, outstanding RF performance over the entire operating band and excellent power handling capability, the LP-STRH-4.3-10 product is unequalled. Its fully weatherized housing meeting IP67 standard allows for outdoor as well as indoor installation.

#### LP-STRH-4.3-10 Series:

- LP-STRH-43FF - 4.3-10 female connector on surge and protected side
- LP-STRH-43MP - 4.3-10 male connector on protected side with 4.3-10 female connector on surge side
- LP-STRH-43MS - 4.3-10 male connector on surge side with 4.3-10 female connector on protected side

# Times-Protect®

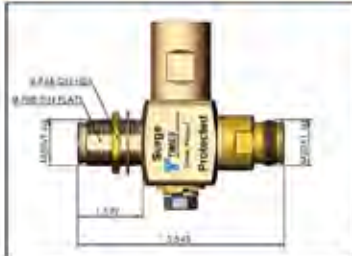

• LP-STRH-43FF

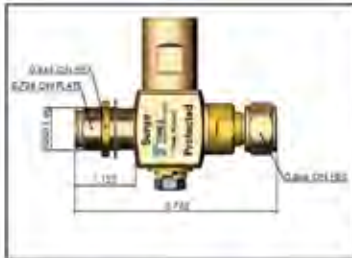

• LP-STRH-43MP

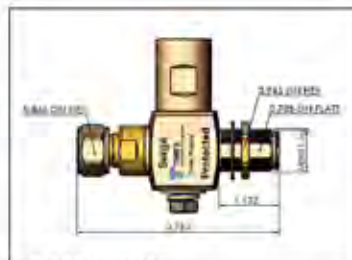

• LP-STRH-43MS

\*All dimensions shown in inches

## Electrical Specifications

Impedance	50 Ω
Frequency Range	700-2700 MHz
VSWR/Return Loss	< 1.15:1 / < -24dB
Insertion Loss	< 0.1dB
Average Power	750 Watts
PIM	< -160 dBc
Maximum Surge Current	50kA (8x20µs wave-form)
Residual Pulse Voltage	< 100V (50kA 8x20µs wave-form)
Residual Pulse Voltage	< 1V (4kV/2kA 1.2x50/8x20µs wave-form)
Energy Throughput Rating	< 1nJ (4kV/2kA 1.2x50/8x20µs wave-form)
Protection Circuit	DC Blocked

## Mechanical / Environmental Specifications

Temp Range Storage/Operating	-40°C - +85°C
Weatherization	IEC 60068 55/155/56 & IP67
Thermal Shock	US MIL-STD 202, Meth.107, Cond.B
Vibration	US MIL-STD 202, Meth.204, Cond.B
Shock	US MIL-STD 202, Meth.213, Cond.1
RoHS Compliant	Yes
Wear/Mating Cycles	500 minimum
Recommended Coupling Nut Torque	90 in-lb
Unit Weight	0.53kg/pc 1.17lb

## Material Specifications

Component	Material	Plating
Body	Brass	White Bronze
Inner Conductor Male	Brass	Silver
Inner Conductor Female	Phosphor Bronze	Silver
Coupling Nut	Brass	White Bronze
Insulator	PTFE	--
O-Ring	Silicone Rubber	--





## Times Protect<sup>®</sup>

### *LP-GPX-05-N Series L1, L2 & L3 GPS Protector*

- *Bidirectional Filter Based Design*
  - *Outstanding IL/RL Characteristics*
  - *DC Blocked RF path for Superior Performance*
- *Solid State DC Path Protection Circuit*
- *Fully Weatherized Housing*

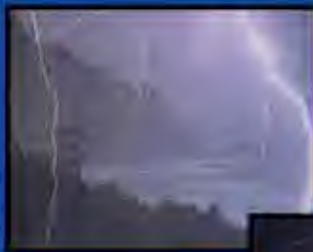

*ISO 9001 Certified*



### *Lightning and Surge Protection for The 21st Century<sup>™</sup>*

The LP-GPX-05-N high performance series is an exceptional DC pass design for protection of GPS receivers requiring up to 5Vdc power to be supplied on the center pin.

While the RF path is DC blocked, the biased DC voltage protection circuit uses Solid State protection technology to provide unsurpassed surge performance. The LP-GPX-05-N series offers outstanding Insertion Loss and Return Loss characteristics over the 1000-2000MHz band, making it suitable for protection of commercial and military GPS, as well as other applications in this band.

Unlike competitive protectors, the white bronze plated construction of the LP-GPX-05-N series eliminates potential galvanic corrosion issues and provides long life in hostile environments. The fully weatherized housing is sealed to IP65 allowing for outdoor as well as indoor installation.

#### LP-GPX-05-N Series:

- LP-GPX-05-NFF  
N Female connectors on surge and protected sides - bidirectional
- LP-GPX-05-NFM  
N Male connector on one side & N Female connector on the other side - bidirectional

# Times-Protect®

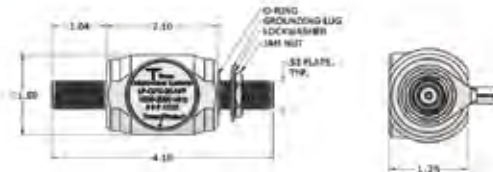

- LP-GPX-05-NFF  
1000 - 2000MHz N Type F/F

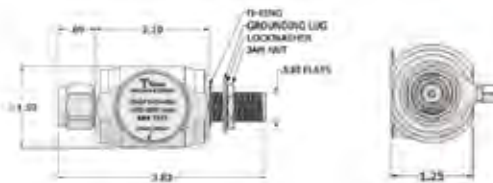

- LP-GPX-05-NFM  
1000 - 2000MHz N Type F/M

\*All dimensions shown in inches

Electrical Specifications	
Impedance	50 Ω
Frequency Range	1000 - 2000 MHz
VSWR/ Return Loss	1.2:1 / <20dB
Insertion Loss	< 0.1dB
Average Power	50W
Maximum Surge Current	10kA multiple (1.2x50/8x20µs wave-form)
Turn on-Voltage	6Vdc
Residual Pulse Voltage	< 12V (6kV/3kA 1.2x50/8x20µs wave-form)
Energy Throughput	< 110µJ
Protection Circuit	DC Blocked RF Path/Solid State DC Pass

Mechanical / Environmental Specifications	
Temp Range Storage/Operating	-40°C - +85°C
Weatherization	IEC 60529 IP65
Thermal Shock	US MIL-STD 202, Meth.107,Cond.B
Vibration	US MIL-STD 202, Meth.204,Cond.B
Shock	US MIL-STD 202, Meth.213,Cond.I
RoHS Compliant	Yes
Mating Life Cycle	> 500
Recommended Coupling Nut Torque	7 - 10 in-lb

Material Specifications		
Component	Material	Plating
Body	Aluminum	White Bronze
Connector Housing	Brass	White Bronze
Inner Conductor Male	Brass	Silver
Inner Conductor Female	Phosphor Bronze	Silver
Coupling Nut	Brass	White Bronze
Insulator	PTFE	--
O-Ring	Silicone Rubber	--

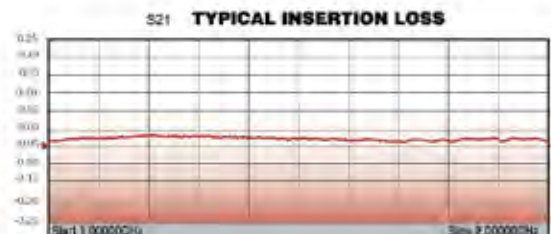

## Times Protect<sup>®</sup>

### LP-GPX-05-S Series L1, L2 & L3 GPS Protector

- Bidirectional Filter Based Design
  - Outstanding IL/RL Characteristics
  - DC Blocked RF path for Superior Performance
- Solid State DC Path Protection Circuit
- Fully Weatherized Housing



ISO 9001 Certified

### Lightning and Surge Protection for The 21st Century<sup>™</sup>

The LP-GPX-05-S high performance series is an exceptional DC pass design for protection of GPS receivers requiring up to 5Vdc power to be supplied on the center pin.

While the RF path is DC blocked, the biased DC voltage protection circuit uses Solid State protection technology to provide unsurpassed surge performance. The LP-GPX-05-S series offers outstanding Insertion Loss and Return Loss characteristics over the 1000-2000MHz band, making it suitable for protection of commercial and military GPS, as well as other applications in this band.

Unlike competitive protectors, the white bronze plated construction of the LP-GPX-05-S series eliminates potential galvanic corrosion issues and provides long life in hostile environments. The fully weatherized housing is sealed to IP65 allowing for outdoor as well as indoor installation.

#### LP-GPX-05-S Series:

- LP-GPX-05-SFF  
SMA Female connectors on surge and protected sides - bidirectional
- LP-GPX-05-SFM  
SMA Male connector on one side & SMA Female connector on the other side - bidirectional

# Times-Protect®



- LP-GPX-05-SFF  
1000 - 2000MHz SMA Type F/F

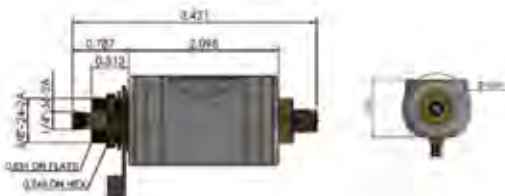

- LP-GPX-05-SFM  
1000 - 2000MHz SMA Type F/M

\*All dimensions shown in inches

Electrical Specifications		
Impedance	50 Ω	
Frequency Range	1000 - 2000 MHz	
VSWR/ Return Loss	1.2:1 / <-20dB	
Insertion Loss	< 0.1dB	
Average Power	50W	
Maximum Surge Current	10kA multiple (1.2x50/8x20µs wave-form)	
Turn on-Voltage	6Vdc	
Residual Pulse Voltage	< 12V (6kV/3kA 1.2x50/8x20µs wave-form)	
Energy Throughput	< 110µJ	
Protection Circuit	DC Blocked RF Path/Solid State DC Pass	
Mechanical / Environmental Specifications		
Temp Range Storage/Operating	-40°C - +85°C	
Weatherization	IEC 60529 IP65	
Thermal Shock	US MIL-STD 202, Meth.107,Cond.B	
Vibration	US MIL-STD 202, Meth.204,Cond.B	
Shock	US MIL-STD 202, Meth.213,Cond.I	
RoHS Compliant	Yes	
Mating Life Cycle	> 500	
Recommended Coupling Nut Torque	3 - 5 in-lb	
Material Specifications		
Component	Material	Plating
Body	Aluminum	White Bronze
Connector Housing	Brass	White Bronze
Inner Conductor Male	Brass	Silver
Inner Conductor Female	Phosphor Bronze	Silver
Coupling Nut	Brass	White Bronze
Insulator	PTFE	--
O-Ring	Silicone Rubber	--



# Times Protect<sup>®</sup>

## LP-GPX-05-T Series L1, L2 & L3 GPS Protector

- Bidirectional Filter Based Design
  - Outstanding IL/RL Characteristics
  - DC Blocked RF path for Superior Performance
- Solid State DC Path Protection Circuit
- Fully Weatherized Housing



ISO 9001 Certified



## Lightning and Surge Protection for The 21st Century™

The LP-GPX-05-T high performance series is an exceptional DC pass design for protection of GPS receivers requiring up to 5Vdc power to be supplied on the center pin.

While the RF path is DC blocked, the biased DC voltage protection circuit uses Solid State protection technology to provide unsurpassed surge performance. The LP-GPX-05-T series offers outstanding Insertion Loss and Return Loss characteristics over the 1000-2000MHz band, making it suitable for protection of commercial and military GPS, as well as other applications in this band.

Unlike competitive protectors, the white bronze plated construction of the LP-GPX-05-T series eliminates potential galvanic corrosion issues and provides long life in hostile environments. The fully weatherized housing is sealed to IP65 allowing for outdoor as well as indoor installation.

### LP-GPX-05-T Series:

- LP-GPX-05-TFF  
TNC Female connectors on surge and protected sides - bidirectional
- LP-GPX-05-TFM  
TNC Male connector on one side & TNC Female connector on the other side - bidirectional

# Times-Protect®

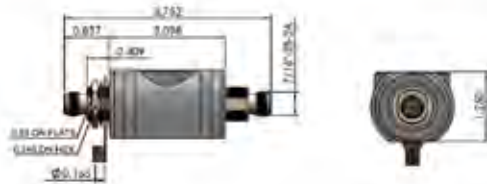

• LP-GPX-05-TFF  
1000 - 2000MHz TNC Type F/F

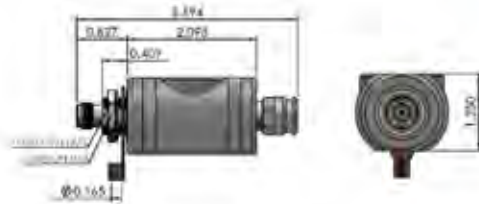

• LP-GPX-05-TFM  
1000 - 2000MHz TNC Type F/M

\*All dimensions shown in inches

Electrical Specifications	
Impedance	50 Ω
Frequency Range	1000 - 2000 MHz
VSWR/ Return Loss	1.2:1 / <-20dB
Insertion Loss	< 0.1dB
Average Power	50W
Maximum Surge Current	10kA multiple (1.2x50/8x20µs wave-form)
Turn on-Voltage	6Vdc
Residual Pulse Voltage	< 12V (6kV/3kA 1.2x50/8x20µs wave-form)
Energy Throughput	< 110µJ
Protection Circuit	DC Blocked RF Path/Solid State DC Pass

Mechanical / Environmental Specifications	
Temp Range Storage/Operating	-40°C - +85°C
Weatherization	IEC 60529 IP65
Thermal Shock	US MIL-STD 202, Meth.107,Cond.B
Vibration	US MIL-STD 202, Meth.204,Cond.B
Shock	US MIL-STD 202, Meth.213,Cond.I
RoHS Compliant	Yes
Mating Life Cycle	> 500
Recommended Coupling Nut Torque	4 - 6 in-lb

Material Specifications		
Component	Material	Plating
Body	Aluminum	White Bronze
Connector Housing	Brass	White Bronze
Inner Conductor Male	Brass	Silver
Inner Conductor Female	Phosphor Bronze	Silver
Coupling Nut	Brass	White Bronze
Insulator	PTFE	--
O-Ring	Silicone Rubber	--

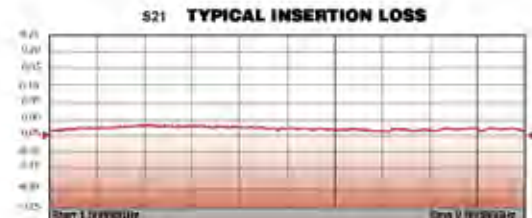

# TimesProtect®

## LP-GTV-N Series

- DC Pass Multi-Strike Design
- Broadband Bidirectional Design
- Excellent IL/RL Performance Over the Entire Operating Frequency Band
- Fully Weatherized Housing
- White Bronze Plated for Durability and Long Life



ISO 9001 Certified



## Lightning and Surge Protection for The 21st Century™

The TimesProtect® LP-GTV-N series is an exceptional broadband DC pass design for lightning protection applications requiring DC power to be supplied to the electronics. These devices exhibit outstanding RF performance with high surge current handling characteristics and cover a broad range of applications requiring up to 150W of RF power handling. Its fully weatherized housing meeting IP67 standard allows for outdoor as well as indoor installation. The N connector designs cover the entire frequency spectrum from DC through 7000MHz.

### LP-GTV-N Series:

- LP-GTV-NFF (150W)  
N Female connectors on both sides - bidirectional
- LP-GTV-NFM (150W)  
N Male connector on one side & N Female connector on the other side - bidirectional

# Times-Protect®

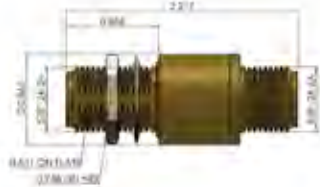

- LP-GTV-NFF  
DC Pass N Type F/F



- LP-GTV-NFM  
DC Pass N Type F/M



- Grounding Ring

\*All Dimensions shown in inches

Electrical Specifications	
Impedance	50 Ω
Frequency Range	DC-7000 MHz
VSWR/Return Loss	< 1.2:1 / < -20dB (DC-6700MHz) < 1.3:1 / < -17dB (6700-7000MHz)
Insertion Loss	< 0.2dB (DC-6700MHz) < 0.3dB (6700-7000MHz)
Maximum Surge Current	10kA multiple (8x20μs wave-form)
Impulse Sparkover	700V (1kV/μs)
Turn on	180Vdc
Average Power	150 Watts
Protection Circuit	DC Pass

Mechanical / Environmental Specifications	
Temp Range Storage/Operating	-40°C - +85°C
Weatherization	IEC 60068 40/085/21 & IP67
Thermal Shock	US MIL-STD 202, Meth.107,Cor
Vibration	US MIL-STD 202, Meth.204,Cor
Shock	US MIL-STD 202, Meth.213,Cor
RoHS Compliant	Yes
Wear/Mating Cycles	500 minimum
Recommended Coupling Nut Torque	7 to 10 lb-in
Unit Weight	1.41 oz / 40 grams

Material Specifications		
Component	Material	Plating
Body	Aluminum	White Bronze
Inner Conductor Male	Brass	Silver
Inner Conductor	Phosphor Bronze	Silver
Washer	Brass	White Bronze
Coupling Nut	Brass	White Bronze
Insulator	PTFE	--
O-Ring	Silicone Rubber	--

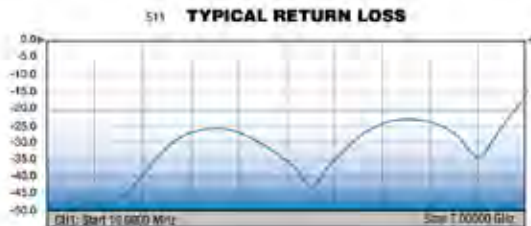



# TimesProtect®

## LP-GTV-T Series

- DC Pass Multi-Strike Design
- Broadband Bidirectional Design
- Excellent IL/RL Performance Over the Entire Operating Frequency Band
- Fully Weatherized Housing
- White Bronze Plated for Durability and Long Life



ISO 9001 Certified



## Lightning and Surge Protection for The 21st Century™

The TimesProtect® LP-GTV-T series is an exceptional broadband DC pass design for lightning protection applications requiring DC power to be supplied to the electronics. These devices exhibit outstanding RF performance with high surge current handling characteristics and cover a broad range of applications requiring up to 150W of RF power handling. Its fully weatherized housing meeting IP67 standard allows for outdoor as well as indoor installation. The TNC connector designs cover the entire frequency spectrum from DC through 6000MHz.

### LP-GTV-T Series:

- LP-GTV-TFF (150W)  
TNC Female connectors on both sides - bidirectional
- LP-GTV-TFM (150W)  
TNC Female connector on one side & TNC Male connector on the other side - bidirectional
- LP-GTV-RTFF (150W)  
R-TNC Female connectors on both sides - bidirectional
- LP-GTV-RTFM (150W)  
R-TNC Female connector on one side & R-TNC Male connector on the other side - bidirectional

# Times-Protect®



• LP-GTV-TFF  
DC Pass TNC Type F/F



• LP-GTV-TFM  
DC Pass TNC Type F/M



• LP-GTV-RTFF  
DC Pass RTNC Type F/F



• LP-GTV-RTFM  
DC Pass RTNC Type F/M

Electrical Specifications	
Impedance	50 Ω
Frequency Range	DC-6000 MHz
VSWR/Return Loss	< 1.3:1 / < -18dB (DC-6000MHz)
Insertion Loss	< 0.15dB (DC-6000MHz)
Maximum Surge Current	10kA multiple (8x20µs wave-form)
Impulse Sparkover	700V (1kV/µs)
Turn on	180Vdc
Average Power	150 Watts
Protection Circuit	DC Pass

Mechanical / Environmental Specifications	
Temp Range Storage/Operating	-40°C - +85°C
Weatherization	IEC 60068 40/085/21 & IP67
Thermal Shock	US MIL-STD 202, Meth.107, Cond.B
Vibration	US MIL-STD 202, Meth.204, Cond.B
Shock	US MIL-STD 202, Meth.213, Cond.I
RoHS Compliant	Yes
Wear/Mating Cycles	500 minimum
Recommended Coupling Nut Torque	4 - 6 in-lbs
Unit Weight	1.41 oz / 40 grams

Material Specifications		
Component	Material	Plating
Body	Aluminum	White Bronze
Inner Conductor Male	Brass	Silver
Inner Conductor Female	Phosphor Bronze	Silver
Washer	Brass	White Bronze
Coupling Nut	Brass	White Bronze
Insulator	PTFE	--
O-Ring	Silicone Rubber	--

\*All Dimensions shown in inches.

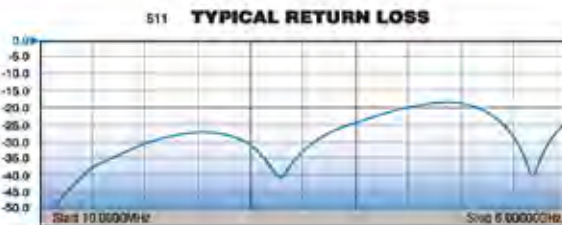

## Times Protect<sup>®</sup>

### *LP-18-195-N Connector Protector*

- *Eliminates the Need for Separate Cable Connector*
- *Attaches Directly to LMR<sup>®</sup>-195 Cable*
- *Uses EZ-195-X (No Braid Trim) Connector Interface*
- *DC Pass Multi-Strike Broadband Bidirectional Design*
- *Fully Weatherized Housing*
- *Solid Brass Construction*
- *White Bronze Plated for Durability and Long Life*



*ISO 9001 Certified*



### *Cable Connector and Lightning Protector in One!*

The Times Protect<sup>®</sup> LP-18-195-N series is an exceptional in-line broadband DC pass surge protection design incorporating lightning protection circuitry and the EZ-195-X series crimp style connector interface unit. This combination allowing the in-line surge protector to be attached directly to the LMR<sup>®</sup>-195 cable eliminates the cable connector needed when using conventional lightning protectors. The LP-18-195-N series protectors exhibit outstanding RF performance over the entire frequency spectrum from DC through 6000MHz and the elimination of the extra connector further reduces return loss, insertion loss and lowers cost. In addition, its fully weatherized housing meets the IP-67 standard for outdoor as well as indoor installation.

#### LP-18-195-N Series:

- LP-18-195-NF-X (150W)  
N Female connector on one side and EZ-195-X crimp style interface on the other side - bidirectional
- LP-18-195-NMH-X (150W)  
N Male connector on one side and EZ-195-X crimp style interface on the other side - bidirectional

The LP-18-195-N series protectors install easily onto LMR<sup>®</sup>-195 cable using the standard CST-195/200 (3192-102) prep tool and either the CT-240/200/195/100 (3190-667) crimp tool or the CT-U Tool (3192-181) with the Y197 (0.213") hex dies (3190-610).

# Times-Protect®

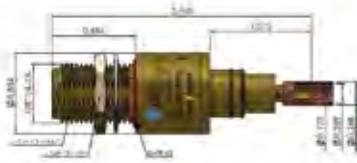

- LP-18-195-NF-X  
DC Pass N Type Female



- LP-18-195-NMH-X  
DC Pass N Type Male

\*All Dimensions shown in inches

### Installation Tools:

CST-195/200 (3192-102) Prep Tool  
 CT-240/200/195/100 (3190-667) Crimp Tool or  
 CT-U Tool with Y197 (0.213") hex dies



CST-195/200



CT-240/200/195/100



CT-U and Y197

Electrical Specifications	
Impedance	50 Ω
Frequency Range	DC-6000 MHz
VSWR/Return Loss	< 1.3:1 / <18dB (DC-6000MHz)
Insertion Loss	<0.6dB (DC-6000MHz)
Maximum Surge Current	10kA multiple (8x20µs wave-form)
Impulse Sparkover	700V (1kV/µs)
Turn on	180Vdc
Average Power	150 Watts
Protection Circuit	DC Pass

Mechanical / Environmental Specifications	
Temp Range Storage/Operating	-40°C - +85°C
Weatherization	IEC 60068 40/085/21 & IP67
Thermal Shock	US MIL-STD 202, Meth.107,Cond.B
Vibration	US MIL-STD 202, Meth.204,Cond.B
Shock	US MIL-STD 202, Meth.213,Cond.I
RoHS Compliant	Yes
Wear/Mating Cycles	500 minimum
Recommended Coupling Nut Torque	7 to 10 in-lb.
Unit Weight	3.4 oz / 95 grams

Material Specifications		
Component	Material	Plating
Body	Brass	White Bronze
Inner Conductor Male	Brass	Silver
Inner Conductor Female	Phosphor Bronze	Silver
Washer	Brass	White Bronze
Coupling Nut	Brass	White Bronze
Insulator	PTFE	--
O-Ring	Silicone Rubber	--

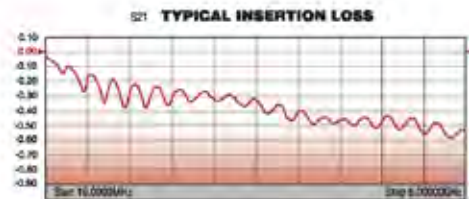
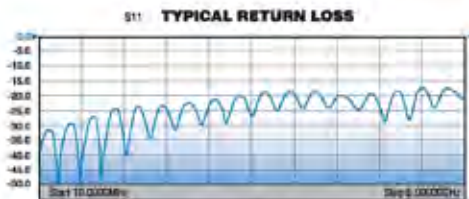

Note: IL and RL data without LMR® cable

## Times Protect<sup>®</sup>

### *LP-18-240-N Connector Protector*

- *Eliminates the Need for Separate Cable Connector*
- *Attaches Directly to LMR<sup>®</sup>-240 Cable*
- *Uses EZ-240-X (No Braid Trim) Connector Interface*
- *DC Pass Multi-Strike Broadband Bidirectional Design*
- *Fully Weatherized Housing*
- *Solid Brass Construction*
- *White Bronze Plated for Durability and Long Life*



*ISO 9001 Certified*



### *Cable Connector and Lightning Protector in One!*

The Times Protect<sup>®</sup> LP-18-240-N series is an exceptional in-line broadband DC pass surge protection design incorporating lightning protection circuitry and the EZ-240-X series crimp style connector interface unit. This combination allowing the in-line surge protector to be attached directly to the LMR<sup>®</sup>-240 cable eliminates the cable connector needed when using conventional lightning protectors. The LP-18-240-N series protectors exhibit outstanding RF performance over the entire frequency spectrum from DC through 6000MHz and the elimination of the extra connector further reduces return loss, insertion loss and lowers cost. In addition, its fully weatherized housing meets the IP-67 standard for outdoor as well as indoor installation.

#### LP-18-240-N Series:

- LP-18-240-NF-X (150W)  
N Female connector on one side and EZ-240-X crimp style interface on the other side - bidirectional
- LP-18-240-NMH-X (150W)  
N Male connector on one side and EZ-240-X crimp style interface on the other side - bidirectional

The LP-18-240-N series protectors install easily onto LMR-240<sup>®</sup> cable using the standard CST-240A (3192-152) prep tool and either the CT-240/200/195/100 (3190-667) crimp tool or the CT-U crimp handle (3192-181) with the Y375 (0.255") hex dies (3190-608).

# Times-Protect<sup>®</sup>



• LP-18-240-NF-X  
DC Pass N Type Female



• LP-18-240-NMH-X  
DC Pass N Type Male

\*All Dimensions shown in inches

**Installation Tools:**

- CST-240A (3192-152) Prep Tool
- CT-240/200/195/100 (3190-667) Crimp Tool or CT-U Crimp Tool with Y375 (0.255") hex dies

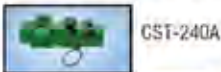

**Electrical Specifications**

Impedance	50 Ω
Frequency Range	DC-6000 MHz
VSWR/Return Loss	< 1.3:1 / <18dB (DC-6000MHz)
Insertion Loss	<0.6dB (DC-6000MHz)
Maximum Surge Current	10kA multiple (8x20µs wave-form)
Impulse Sparkover	700V (1kV/µs)
Turn on	180Vdc
Average Power	150 Watts
Protection Circuit	DC Pass

**Mechanical / Environmental Specifications**

Temp Range Storage/Operating	-40°C - +85°C
Weatherization	IEC 60068 40/085/21 & IP67
Thermal Shock	US MIL-STD 202, Meth.107, Cond.B
Vibration	US MIL-STD 202, Meth.204, Cond.B
Shock	US MIL-STD 202, Meth.213, Cond.I
RoHS Compliant	Yes
Wear/Mating Cycles	500 minimum
Recommended Coupling Nut Torque	7 to 10 in-lb
Unit Weight	3.4 oz / 95 grams

**Material Specifications**

Component	Material	Plating
Body	Brass	White Bronze
Inner Conductor Male	Brass	Silver
Inner Conductor Female	Phosphor Bronze	Silver
Washer	Brass	White Bronze
Coupling Nut	Brass	White Bronze
Insulator	PTFE	--
O-Ring	Silicone Rubber	--



Note: IL and RL data without LMR<sup>®</sup> cable

## Times Protect<sup>®</sup>

### *LP-18-400-N Connector Protector*

- *Eliminates the Need for Separate Cable Connector*
- *Attaches Directly to LMR<sup>®</sup>-400 Cable*
- *Uses EZ-400-X (No Braid Trim) Connector Interface*
- *DC Pass Multi-Strike Broadband Bidirectional Design*
- *Fully Weatherized Housing*
- *Solid Brass Construction*
- *White Bronze Plated for Durability and Long Life*



*ISO 9001 Certified*



### *Cable Connector and Lightning Protector in One!*

The Times Protect<sup>®</sup> LP-18-400-N series is an exceptional in-line broadband DC pass surge protection design incorporating lightning protection circuitry and the EZ-400-X series crimp style connector interface unit. This combination allowing the in-line surge protector to be attached directly to the LMR<sup>®</sup>-400 cable eliminates the cable connector needed when using conventional lightning protectors. The LP-18-400-N series protectors exhibit outstanding RF performance over the entire frequency spectrum from DC through 6000MHz and the elimination of the extra connector further reduces return loss, insertion loss and lowers cost. In addition, its fully weatherized housing meets the IP-67 standard for outdoor as well as indoor installation.

#### LP-18-400-N Series:

- LP-18-400-NF-X (150W)  
N Female connector on one side and EZ-400-X crimp style interface on the other side - bidirectional
- LP-18-400-NMH-X (150W)  
N Male connector on one side and EZ-400-X crimp style interface on the other side - bidirectional

The LP-18-400-N series protectors install easily onto LMR<sup>®</sup>-400 cable using the standard CST-400 prep tool and either the CT-400/300 crimp tool or the CT-U crimp handle (3192-181) with the Y1719 (0.429") hex dies.

# Times-Protect®

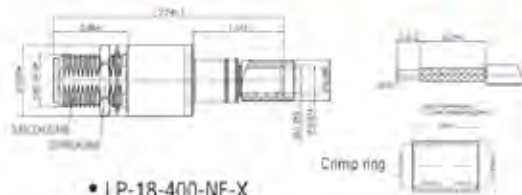

• LP-18-400-NF-X  
DC Pass N Type Female

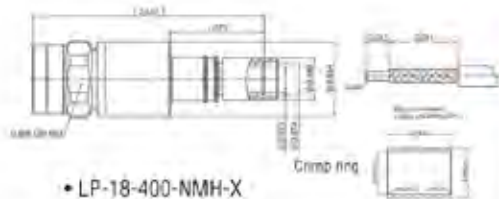

• LP-18-400-NMH-X  
DC Pass N Type Male

\*All Dimensions shown in inches

### Installation Tools:

CST-400 Prep Tool  
CT-400/300 Crimp Tool or CT-U Crimp Tool  
with Y1719 (0.429") hex dies



CST-400



CT-400/300



CT-U and Y1719

### Electrical Specifications

Impedance	50 Ω
Frequency Range	DC-6000 MHz
VSWR/Return Loss	< 1.15:1 / <23dB (DC-6000MHz)
Insertion Loss	<0.15dB (DC-6000MHz)
Maximum Surge Current	10kA multiple (8x20µs wave-form)
Impulse Sparkover	700V (1kV/µs)
Turn on	180Vdc
Average Power	150 Watts
Protection Circuit	DC Pass

### Mechanical / Environmental Specifications

Temp Range Storage/Operating	-40°C - +85°C
Weatherization	IEC 60068 40/085/21 & IP67
Thermal Shock	US MIL-STD 202, Meth.107,Cond.B
Vibration	US MIL-STD 202, Meth.204,Cond.B
Shock	US MIL-STD 202, Meth.213,Cond.I
RoHS Compliant	Yes
Wear/Mating Cycles	500 minimum
Recommended Coupling Nut Torque	7 to 10 lb-in
Unit Weight	3.4 oz / 95 grams

### Material Specifications

Component	Material	Plating
Body	Brass	White Bronze
Inner Conductor Male	Brass	Silver
Inner Conductor Female	Phosphor Bronze	Silver
Washer	Brass	White Bronze
Coupling Nut	Brass	White Bronze
Insulator	PTFE	--
O-Ring	Silicone Rubber	--

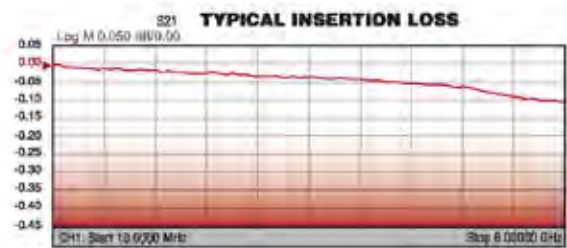

Note: IL and RL data without LMR®-400 cable



# Times Protect<sup>®</sup>

## LP-WBX Series

- Filter based Protection Circuit
  - Broadband Outstanding IL/RL
  - DC Blocked for Superior Surge Performance
  - Ultra Broadband Multi-Strike Design
- Fully Weatherized Housing



## Lightning and Surge Protection for The 21st Century™

The LP-WBX-N high performance series uses a filter circuit to provide exceptional lightning protection over the 2000-6000MHz frequency band, covering both the unlicensed WiFi bands and several licensed operating bands.

Unlike competitive protectors, the white bronze plated construction of the LP-WBX-N series eliminates potential galvanic corrosion issues and provides long life in hostile environments. The fully weatherized housing is sealed to IP65 allowing for outdoor as well as indoor installation.

### LP-WBX-N Series:

- LP-WBX-NFF  
N Female connectors on surge and protected sides
- LP-WBX-NMP  
N Male connector on protected side with N Female connector on surge side
- LP-WBX-NMS  
N Male connector on surge side with N Female connector on protected side

# Times-Protect®

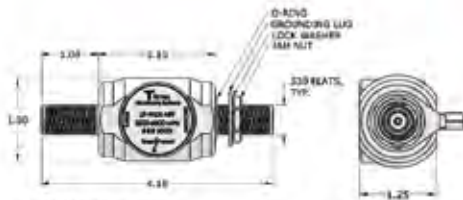

- LP-WBX-NFF  
2000 - 6000MHz N Type F/F



- LP-WBX-NMP  
2000 - 6000MHz N Type M on Protected

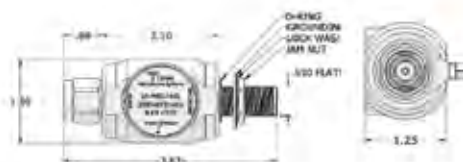

- LP-WBX-NMS  
2000 - 6000MHz N Type M on Surge

\*All dimensions shown in inches

Electrical Specifications	
Impedance	50 Ω
Frequency Range	2000 - 6000 MHz
VSWR/Return Loss	<1.2:1 / <-20dB
Insertion Loss	< 0.2dB
Average Power	50W
Maximum Surge Current	20kA max/10kA multiple (8x20μs wave-form)
Residual Pulse Voltage	< 3V (6kV/3kA 1.2x50/8x20μs wave-form)
Energy Throughput	<150nJ
Protection Circuit	DC Blocked

Mechanical / Environmental Specifications	
Temp Range Storage/Operating	-40°C - +85°C
Weatherization	IEC 60529 & IP65
Thermal Shock	US MIL-STD 202, Meth.107,Cond.B
Vibration	US MIL-STD 202, Meth.204,Cond.B
Shock	US MIL-STD 202, Meth.213,Cond.I
RoHS Compliant	Yes
Mating Life Cycle	> 500
Recommended Coupling Nut Torque	7-10 in-lb

Material Specifications		
Component	Material	Plating
Body	Aluminum	White Bronze
Connector Housing	Brass	White Bronze
Inner Conductor Male	Brass	Silver
Inner Conductor Female	Phosphor Bronze	Silver
Coupling Nut	Brass	White Bronze
Insulator	PTFE	--
O-Ring	Silicone Rubber	--

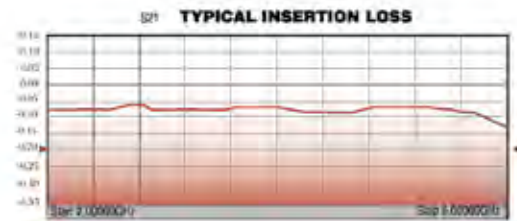
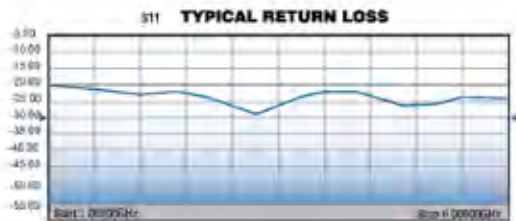

## Times Protect<sup>®</sup>

### *LP-HBX-N Series*

- DC Blocked for Maximum Surge Protection
- Multi-Strike Capability
- Broadband Performance from 100MHz up to 700MHz
- Exceptional RF Characteristics
- High Power Design for Single & Multi Channel Applications



*ISO 9001 Certified*



### *Lightning and Surge Protection for The 21st Century<sup>™</sup>*

The Times Protect<sup>®</sup> LP-HBX-N series high performance surge arrester series addresses applications in the 100MHz-700MHz spectrum. Our unique DC blocking technology employed in this design provides optimum isolation of the antenna port from the protected equipment port for maximum surge protection. LP-HBX-N series surge protectors have exceptional RF performance and are constructed from the highest quality materials for unsurpassed durability and longevity. These units meet and surpass all applicable industry standards.

The LP-HBX-N series product family is available with N connector configurations to satisfy various installation requirements.

#### LP-HBX-N Series:

- LP-HBX-NFF  
N Female connectors on surge and protected sides
- LP-HBX-NMP  
N Male connector on protected side with N Female connector on surge side
- LP-HBX-NMS  
N Male connector on surge side with N Female connector on protected side

# Times-Protect<sup>®</sup>

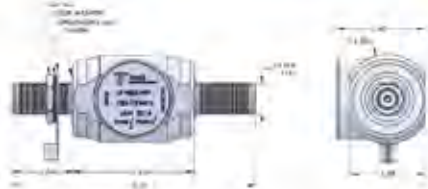

- LP-HBX-NFF  
100-700MHz DC Blocked N Type F/F

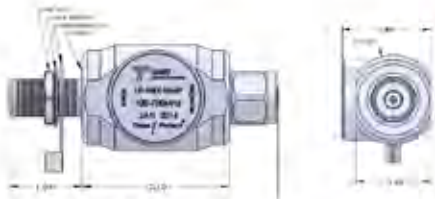

- LP-HBX-NMP  
100-700MHz DC Blocked N Type M on Protected



- LP-HBX-NMS  
100-700MHz DC Blocked N Type M on Surge

\*All dimensions shown in inches

Electrical Specifications		
Impedance	50 Ω	
Frequency Range	100-700 MHz	
VSWR/Return Loss	<1.15:1 / <-23dB	
Insertion Loss	< 0.1dB	
Impulse Discharge Current	20KA multiple (8x20μs wave-form)	
Residual Pulse Voltage	<5V@6kV/3kA (8x20μs wave-form)	
Energy Throughput Rating	<1.4μJ (6kV/3kA 1.2x50/8x20μs wave-form)	
Power Handling	750 Watts	
Protection Circuit	DC Blocked	
Mechanical / Environmental Specifications		
Temp Range Storage/Operating	-40°C - +85°C / -40°C - +50°C	
Weatherization	IP 65	
Thermal Shock	US MIL-STD 202, Meth.107, Cond.B	
Vibration	US MIL-STD 202, Meth.204, Cond.B	
Shock	US MIL-STD 202, Meth.213, Cond.I	
RoHS Compliant	Yes	
Mating Life Cycle	> 500	
Recommended Coupling Nut Torque	7 to 10 in-lb	
Unit Weight	0.2kg/pc / 0.4lb	
Material Specifications		
Component	Material	Plating
Body	Aluminum	White Bronze
Inner Conductor Male	Brass	Silver
Inner Conductor Female	Phosphor Bronze	Silver
Coupling Nut	Brass	White Bronze
Insulator	PTFE	--
O-Ring	Silicone Rubber	--

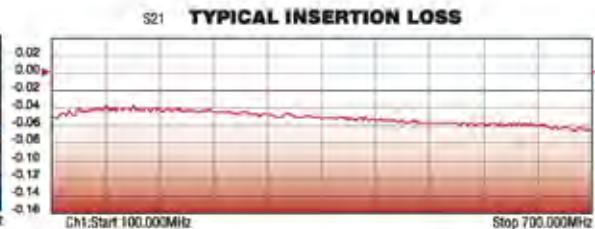
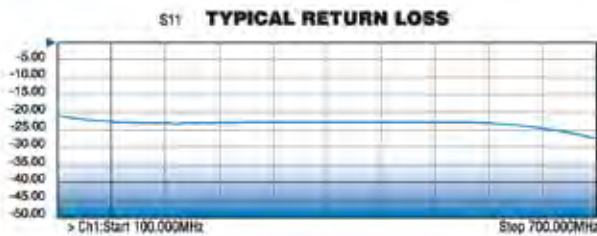

TimesProtect<sup>®</sup>

SmartPanel<sup>®</sup>

**Superior Surge Protection Performance:**

- Bulkhead-Mounted RF Protectors
- True Single Point Ground by Design
- Low Inductance Ground Plate For Control of Ground Potential Rise

**Designed for Easy Installation:**

- Eliminates External Coaxial Grounding Kits
- Eliminates Internal Lightning Protector Trapeze
- Can Accommodate EWG-Data-DC-Fiber Entry Ports
- Works With 4 - 8 Inch Wall Thickness
- Most Prep Work Can Be Performed Off Site
- Minimal On-Site Labor Costs

**No Outside Exposed Copper - Addresses Theft Issues**



*Intelligently designed to effectively conduct lightning current to ground while balancing the need for security and economy*

**T**TIMES MICROWAVE SYSTEMS  
An Amphenol Company

ISO 9001 Certified



*Lightning and Surge Protection for The 21st Century™*

Times Microwave Systems introduces a revolutionary concept in shelter and base station entrance panels. Designed to eliminate traditional entrance panel shortcomings and improve surge protection of expensive base station equipment, the Times-Protect<sup>®</sup> Smart-Panel<sup>®</sup> I offers major advantages compared to traditional installation methods.

The Times-Protect<sup>®</sup> Smart-Panel<sup>®</sup> provides for single point grounding and eliminates costly and time consuming cable ground kits. The external copper master ground bar is also eliminated so there are no copper parts to steal outside the shelter. Inside the shelter the installation is simplified and cost reduced by the elimination of the lightning protector trapeze. Bulkhead mounted lightning protectors eliminate added trapeze ground lead inductance, creating a perfect return path for surge currents during a lightning event.

The completely weatherized Times-Protect<sup>®</sup> Smart-Panel<sup>®</sup> adjusts to the shelter wall thickness and is supplied with all the necessary installation hardware as well as a heavy duty copper internal master ground bar and a low inductance ground plate.

Constructed of powder-coated heavy duty aluminum the Smart-Panel<sup>®</sup> is available in both 12 and 24 port designs and either type N or 716 DIN bulkhead mount configurations. A copper version is also available. All designs can also accommodate EWG, Cat 5 data, DC or Fiber entry ports.

**Times-Protect<sup>®</sup> Smart-Panel<sup>®</sup> Series:**

Part Number	Configuration
LP-SP-12N	12 port N hole
LP-SP-12D	12 port 716 DIN hole
LP-SP-24N	24 port N hole
LP-SP-24D	24 port 716 DIN hole

# Smart-Panel®



### Included Installation Hardware

- 3/8" x 2" tamper Resistant Galv Lag Screw
- 3/8" Short Galv Lag Shield
- 3/8" x 1-3/4" Tamper Resistant Bolt
- 3/8" SS Flat Washer
- 3/8" Lock Washer
- 3/8" SS Hex Nut
- Ground Lug 2/0 AWG
- Tamper Resistant Wrench
- Hole Cutout Template



### Available Accessories

- Lightning Protectors  
Based on Network Requirements
- Feed Through Connectors:  
LP-FT-DFDF (DIN Feed-Through)  
LP-FT-NFNF (N Feed-Through)
- Blank Hole Plugs:  
LP-DP (DIN Hole Plug)  
LP-NP (N Hole Plug)

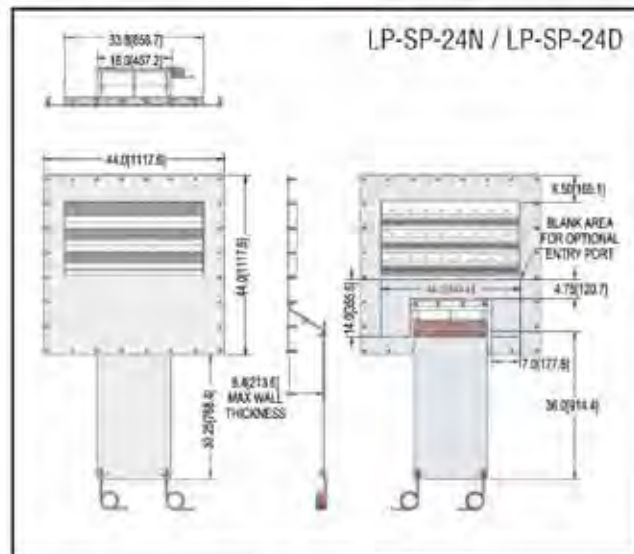
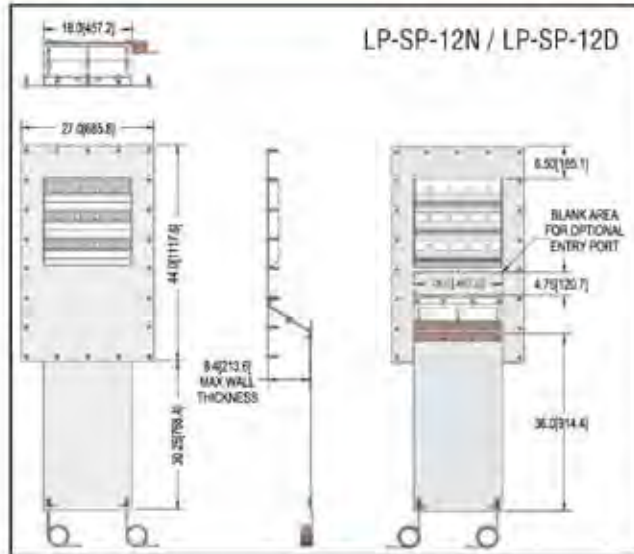

### Specifications

Material:	6061-T6
Master Ground Bar:	C110 Copper
Finish:	Powder Coat
Weight (lbs):	50 (12 Port) 58 (24 Port)



## LP-SPT™

- Measures the voltage protection level of the lightning protection device
- Field portable, lightweight design - weighs only 16 ounces
- Inherently safe circuitry protects personnel
- Can also be used to test MOV's, diodes and gas tubes



ISO 9001 Certified

The innovative LP-SPT™ RF surge protection tester can test any lightning protection device or component to ensure its proper functioning and capability to protect critical and expensive RF equipment. Weighing only 16 ounces and powered by two 9 volt batteries, the ruggedized hand-held unit is completely portable making it ideal for field use. The LP-SPT™ unit has two terminals, N male and N female, to support testing of the most popular in line RF surge protection devices and can easily test surge protectors with any other interfaces by using commonly available RF adaptors. The slim LP-SPT™ unit comes complete with a heavy duty nylon carrying case, batteries, easy-to-follow instructions and a set of alligator clips to allow testing of other surge protection components such as MOV's, diodes and gas tubes.











- Size: 9.0" x 4.0" x 1.5"
- Weight: 16 ounces
- Power: Two 9V batteries
- Display: 3.5" LCD, 2kV max scale
- Test Output: 1kV min, 1mA min, 1.5mA max
- Terminal: N Female & N Male
- Includes:
  - Alligator clip adaptor (LP-NF-AC)
  - Rugged black nylon carrying case
  - Batteries
  - Operating Instructions

#### Special Features:

- Auto shut-off after 10 minutes of non-use
- Auto disable of HV output if the test button is depressed more than 10 seconds (must press again to reactivate)
- ON/OFF and TEST switches resist unintentional activation
- Fast discharge time between test measurements
- Battery management prevents excessive battery drain

# LP-SPT™

## Test Reference Guide Acceptable Voltage Limits

	<u>Protector Test Side</u>	<u>Device Type</u>	<u>Minimum</u>	<u>Maximum</u>	
P-BTR-NFF	Surge side	DC Blocked	480	720	
P-BTR-NMP	Surge side	DC Blocked	480	720	
P-BTR-NMS	Surge side	DC Blocked	480	720	
P-BTRW-NFF	Surge side	DC Blocked	480	720	
P-BTRW-NMP	Surge side	DC Blocked	480	720	
P-BTRW-NMS	Surge side	DC Blocked	480	720	
P-HBX-NFF	Surge side	DC Blocked	0	2	
P-HBX-NMP	Surge side	DC Blocked	0	2	
P-HBX-NMS	Surge side	DC Blocked	0	2	
P-GTR-NFF/NFM	Either side	DC Pass	72	108	
P-GTR-NFF/NFM-23	Either side	DC Pass	184	276	
P-GTR-NFF/NFM-35	Either side	DC Pass	280	420	
P-GTR-DFF/DFM	Either side	DC Pass	72	108	
P-GTR-DFF/DFM-23	Either side	DC Pass	184	276	
P-GTR-DFF/DFM-35	Either side	DC Pass	280	420	
P-GTV-NFF	Either side	DC Pass	144	216	
P-GTV-NFM	Either side	DC Pass	144	216	
P-STRL-DFF	Surge side	DC Blocked	0	2.0	
P-STRL-DMP	Surge side	DC Blocked	0	2.0	
P-STRL-DMS	Surge side	DC Blocked	0	2.0	
P-STRL-NFF	Surge side	DC Blocked	0	2.0	
P-STRL-NMP	Surge side	DC Blocked	0	2.0	
P-STRL-NMS	Surge side	DC Blocked	0	2.0	
P-WBX-NFF	Surge side	DC Blocked	0	2.0	
P-WBX-NMP	Surge side	DC Blocked	0	2.0	
P-WBX-NMS	Surge side	DC Blocked	0	2.0	
P-GPX-05-NFF	Either side	DC Pass	5.0	7.0	
P-GPX-05-NFM	Either side	DC Pass	5.0	7.0	
P-GPX-05-SFF	Either side	DC Pass	5.0	7.0	
P-GPX-05-SFM	Either side	DC Pass	5.0	7.0	
P-GPX-05-TFF	Either side	DC Pass	5.0	7.0	
P-GPX-05-TFM	Either side	DC Pass	5.0	7.0	
P-18-195-NMH-X	Connector	DC Pass	144	216	
P-18-195-NF-X	Connector	DC Pass	144	216	
P-18-400-NMH-X	Connector	DC Pass	144	216	
P-18-400-NF-X	Connector	DC Pass	144	216	





**LP-DOE, POE & PAE**  
**Data Line Over Voltage Protection**

- Tested to RFC2544 extended methods
- Meets Network Equipment Building System (NEBS) Level 3
- Excellent data integrity
- Lowest surge and energy throughput
- Lowest error rate
- Shielded enclosure
- IP67 weatherized version available

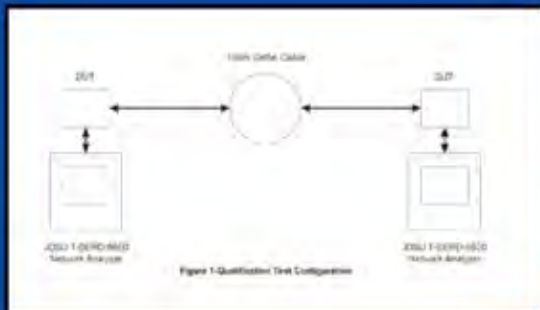

ISO 9001 Certified



**Lightning and Surge Protection**  
**for The 21st Century™**

The Times-Protect® Data Line protector family utilizes a unique leading edge technology to provide surge protection at a level not previously available for twisted pair Cat 5e and Cat 6 cables. The LP-DOE-1-G, LP-POE-1G and LP-PAE-100 have been tested to RFC2544 extended test methods as illustrated in Figure 1. The surge protection performance of this product family surpasses the performance of other available competitive products by a wide margin. The maximum surge rating for these products is only limited by the RJ-45 connector surge voltage and current handling capability.

**LP-DOE-1G 1000 BASE-T ETHERNET DATA**

- 1GB performance per RFC2544 test methods at 100m
- Data protection on all pins, common and differential modes
- Surge Let-through voltage on data lines limited to 20V peak @ 3kA 8x20uS surge test current
- Metallic enclosure with chassis to ground
- Designed for indoor telecom and network applications

**LP-POE-1G 1000 BASE-T POWER OVER ETHERNET**

- 1GB performance per RFC2544 test methods at 100m
- Data protection on all pins, common and differential modes
- Surge Let-through voltage on data lines limited to 20V peak @ 3kA 8x20uS surge test current
- 60VDC protection on DC pins
- Metallic enclosure with chassis to ground

**LP-PAE-100 100 BASE-T POWER AND ETHERNET**

- 10/100 Base-T performance per RFC2544 test methods at 100m
- Data protection on all pins, common and differential modes
- Surge Let-through voltage on data lines limited to 20V peak @ 3kA 8x20uS surge test current
- 60VDC protection on DC pins
- Metallic enclosure with chassis to ground

# Times-Protect<sup>®</sup>

<b>Data Test Method:</b> Extended RFC2544 Test	
<b>Protected pins to chassis:</b>	All pins
<b>Maximum discharge current:</b>	300A, 10/1000uS, per Bellcore 1089 5kA 8 10uS per IEC 61000-4-5
<b>Repetitive discharge:</b> (10 cycles max)	100A, 10/1000uS, per Bellcore 1089 3kA 8/uS per IEC 61000-4-5
<b>Impedance:</b>	100 Ohms nominal
<b>Mechanical</b>	
<b>Dimensions:</b>	4.68" x 2.22" x 1.25"
<b>Weight:</b>	3.7 oz.
<b>Mounting:</b>	Chassis or panel
<b>Environmental</b>	
<b>Operating Temperature:</b>	-40° - +65° C
<b>Relative humidity:</b>	0 to 90% non-condensing

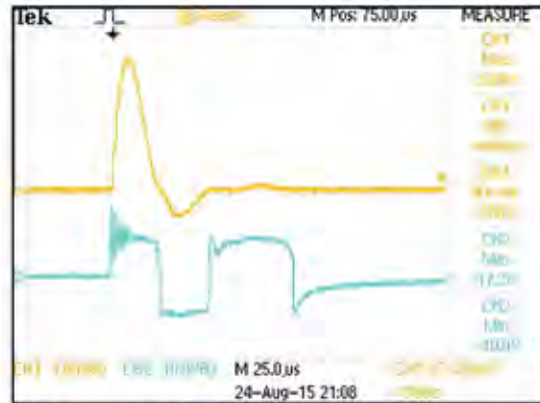

**Surge Performance Data for the LP-DOE-1G**  
 • Channel 1 (yellow trace): Test input surge current 3.24kA 8x20uS wave shape  
 • Channel 2 (blue trace): Let through voltage 17.2Vpk

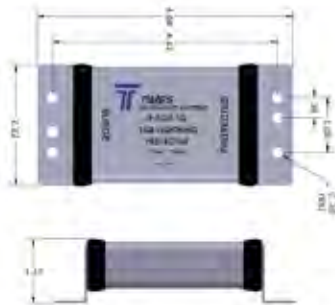

### LP-DOE-1G

**Application:**  
1000 BASE-T, panel mount, indoor  
**Electrical:**  
**Connector:** RJ45 jack, shielded  
**Data Rate:** 1000 Mbps, 1000 BASE-T per IEEE 802.3ab  
**Data Test Method:** Extended RFC2544 tests  
**Protected Pin Pairs:** (1-2), (3-6), (4-5), (7-8)  
**Surge Let Through Voltage:** 20V peak @300A, 10/1000uS, 20V peak @ 5kA, 8/20uS

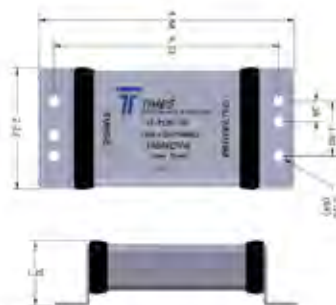

### LP-POE-1G

**Application:**  
1000 BASE-T, panel mount, indoor  
**Electrical:**  
**Connector:** RJ45 jack, shielded  
**DC:** DST EDSTLZ1550/2  
**Data Rate:** 1000 Mbps, 1000 BASE-T per IEEE 802.3ab  
**Protected Pin Pairs:** (1-2), (3-6), (4-5), (7-8)  
**DC Pin Pairs:** (1-2), (3-6), (4-5), (7-8)  
**DC Line Voltage:** +48VDC nominal, +60VDC max  
**DC Line Current:** 250mA operating per line-rtn pair  
 500mA nominal fault per line-rtn pair  
**Surge Let Through Voltage:**  
 Data: 20V peak @300A, 10/1000uS  
 20V peak @ 5kA, 8/20uS  
 DC: 90V peak @ 300A, 10/1000uS, 90V peak @5kA, 8/20uS



### LP-PAE-100

**Application:**  
100 BASE-T, panel mount, indoor  
**Electrical:**  
**Connector:** RJ45 jack, shielded  
**Data Rate:** 100 Mbps, 100 BASE-T per IEEE 802.3ab  
**Protected Pin Pairs:** (1-2), (3-6), (4-5), (7-8)  
**Data Pin Pairs:** (1-2), (3-6)  
**DC Pin Pairs:** Line (4-5), RTN (7-8)  
**DC Line Voltage:** +48VDC nominal, +60VDC max  
**DC Line Current:** 500mA operating per line-rtn pair  
 1100mA nominal fault  
**Surge Let Through Voltage:**  
 Data: 20V peak @300A, 10/1000uS  
 20V peak @ 5kA, 8/20uS  
 DC: 90V peak @ 300A, 10/1000uS, 90V peak @5kA, 8/20uS

**Times Protect**®

### *LP-DCX-W-48V-27A-20* *DC Over Voltage Protection*

- *Multi stage design for lowest surge voltage and energy throughput*
- *Polycarbonate enclosure*
- *IP-68 weatherized housing*
- *Multi strike capability*
- *Best protection for cell site remote radio heads*
- *Hinged cover for easy access*
- *Patent pending design*



**TIMES** MICROWAVE SYSTEMS  
An Amphenol Company

*ISO 9001 Certified*

### *Lightning and Surge Protection* *for The 21st Century™*

The Times Protect LP-DCX-W-48V-27A-20 is a high performance, DC surge protection device ideally suited for protecting DC powered remote radio heads (RRH). By installing the LP-DCX unit at both the top and the bottom of the tower, the RRH and ground based electronics are suitably protected. The multi strike design is fully weatherized to IP-68 and provides by far the lowest surge energy and voltage throughput compared to any available alternate protective device. The LP-DCX-W-48V-27A-20 accommodates 48VDC and a maximum DC operating current of 27 amps. It will handle multiple strikes of 20kA 8x20us surge current discharge and with a maximum throughput voltage of 100Vpeak during full surge current.

#### Specifications:

##### **Electrical:**

Nominal Operating Voltage:	-48VDC
Maximum Operating Voltage:	-60VDC
Maximum Operating Current:	27ADC
Nominal Power:	1300W
Maximum Leakage Current:	45uA
Surge Test Method:	IEC 61000-4-5
Surge Discharge Current:	20kA, 8/20us, >10 strikes
Maximum Let Through Voltage:	100V
Protection Modes:	1) line-return, 2) return-ground, 3) line-ground

##### **Mechanical:**

Dimensions:	7.4" x 8.3" x 5.5"
Weight:	3.0 lb.
Cable Grips:	DC, 2 each 1" dia max
Ground:	1 each 3/8" dia max

##### **Environmental:**

Operating Temperature:	-40° - +85° C
Relative Humidity:	0 to 95% condensing
Weatherization:	IP68
Wire Size:	STO 3C 10AWG

# Times-Protect®

LP-DCX-W-48V-27A-20

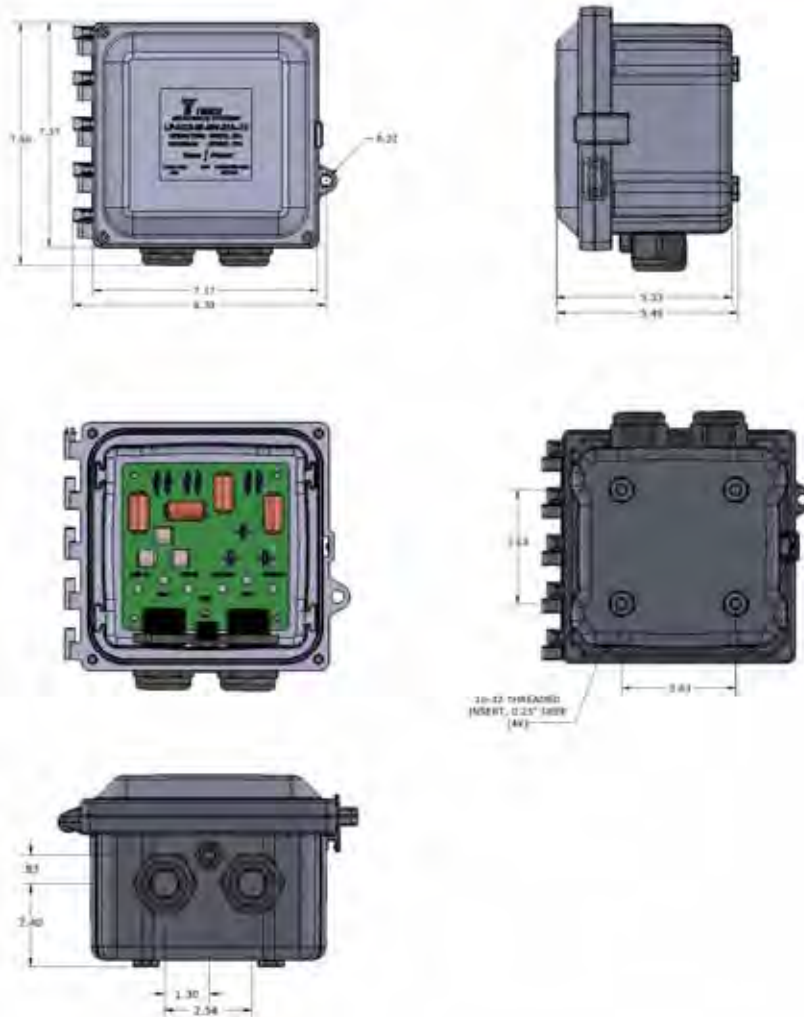

World Headquarters: 358 Hall Avenue, Wallingford, CT 06492 • Tel: 203-949-8400, 1-800-867-2629 • Fax: 203-949-8423  
 International Sales: +1 203-949-8503 • +1 800-867-2629  
 China Sales: No. 318 Yuan Shan Road, Shanghai 201108 China • Tel: 86-21-51761234 • Fax: 86-21-64424098  
[www.timesmicrowave.com](http://www.timesmicrowave.com)

LP-DCX-W 01/16

© 2015, Times Microwave Systems, Wallingford, CT 06492

# Connector Interface Guide

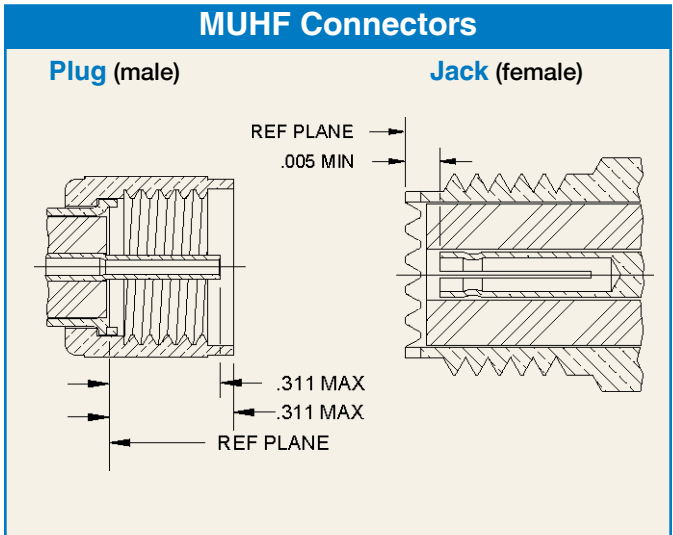
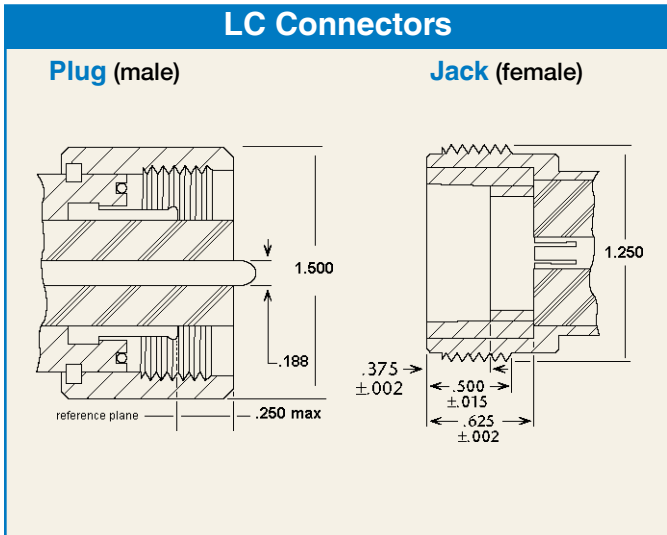
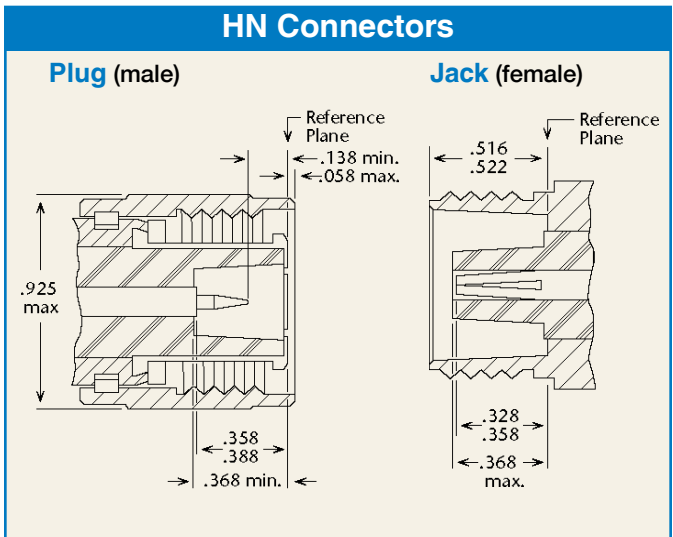
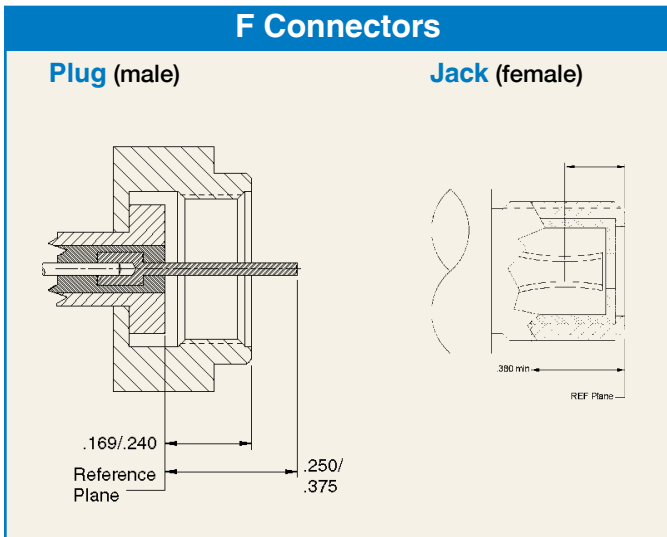
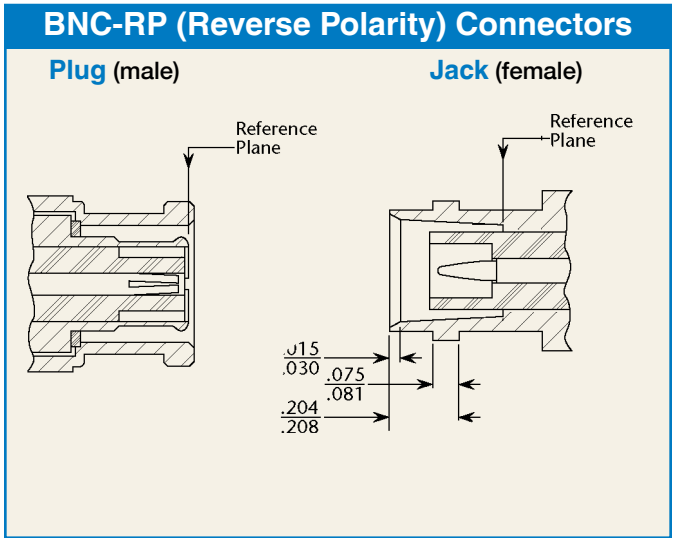
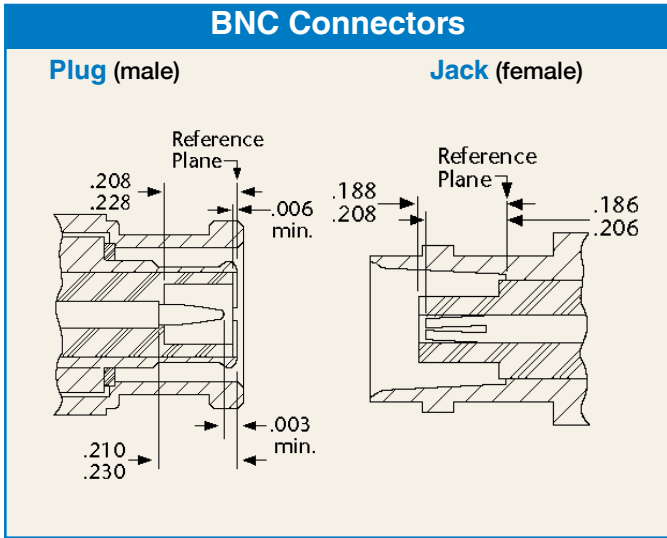

### N Connectors

**Plug (male)**

**Jack (female)**

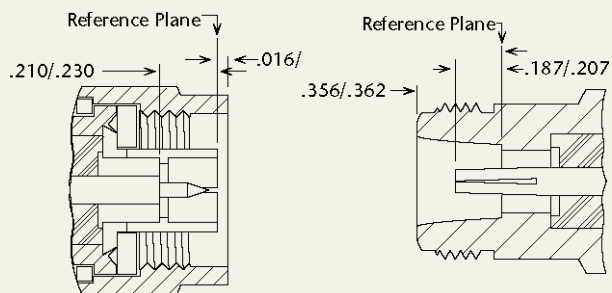

### N-RP (Reverse Polarity) Connectors

**Plug (male)**

**Jack (female)**

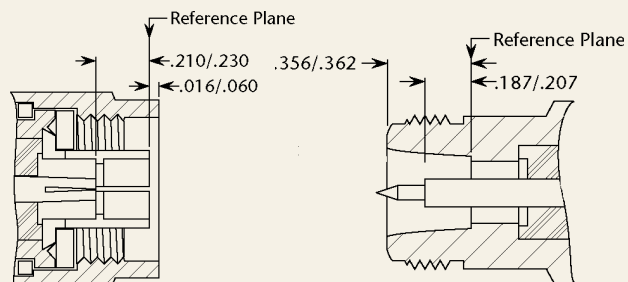

### QDS Connectors

**Plug (male)**

**Jack (female)**

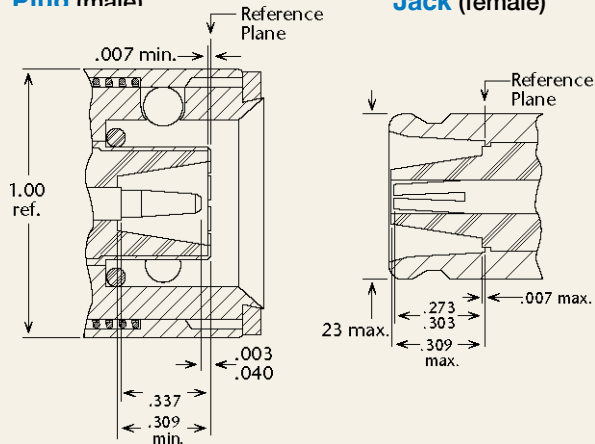

### QMA Connectors

**Plug (male)**

**Jack (female)**

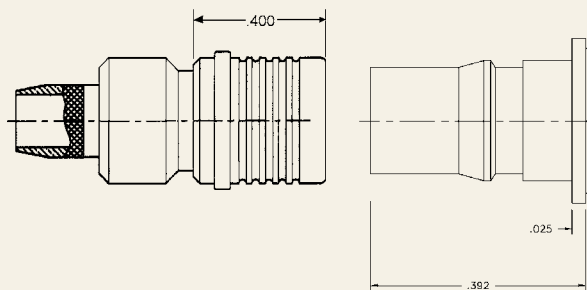

### SMA Connectors

**Plug (male)**

**Jack (female)**

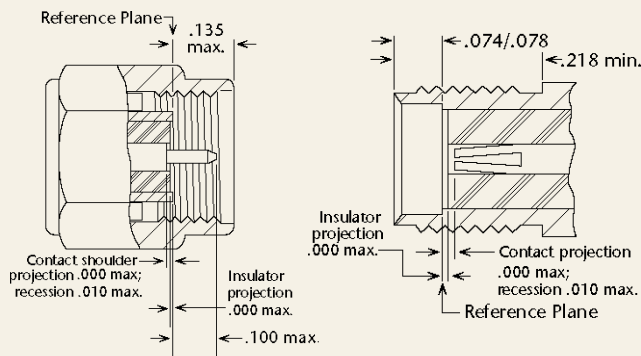

### SMA-RP (Reverse Polarity) Connectors

**Plug (male)**

**Jack (female)**

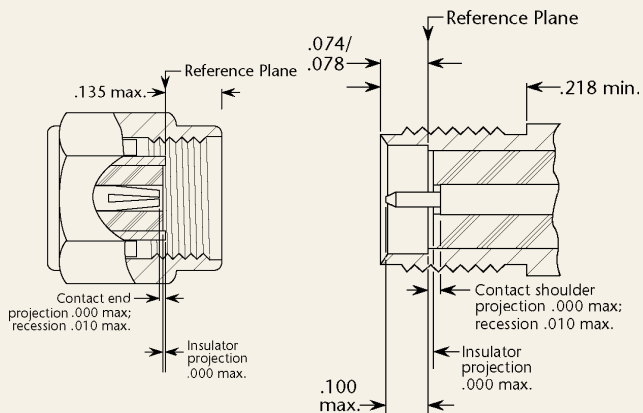

# Connector Interface Guide

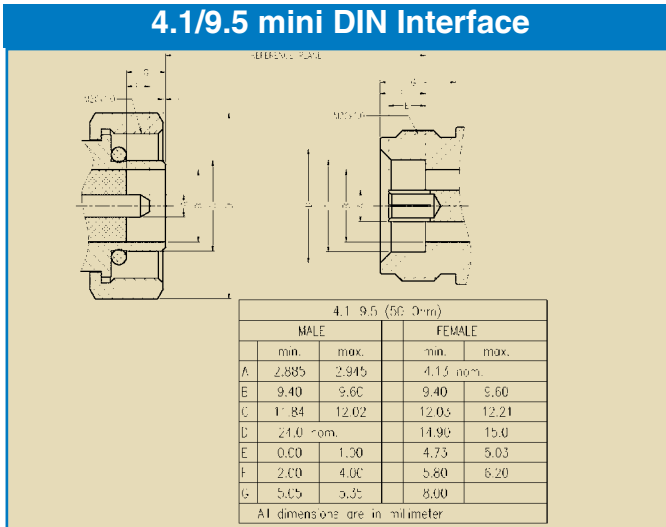
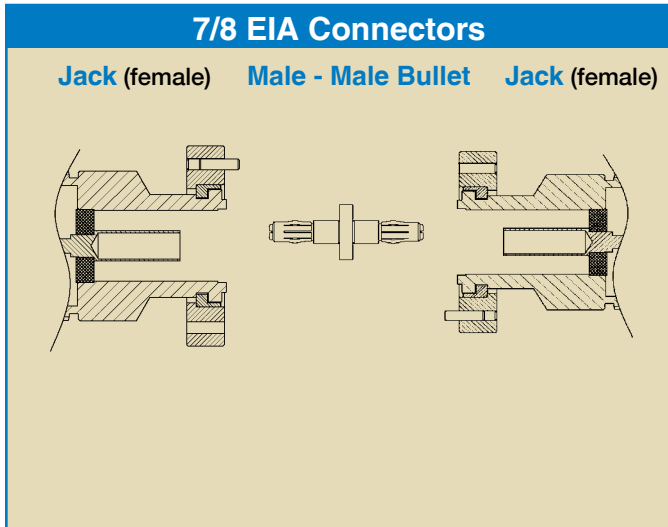
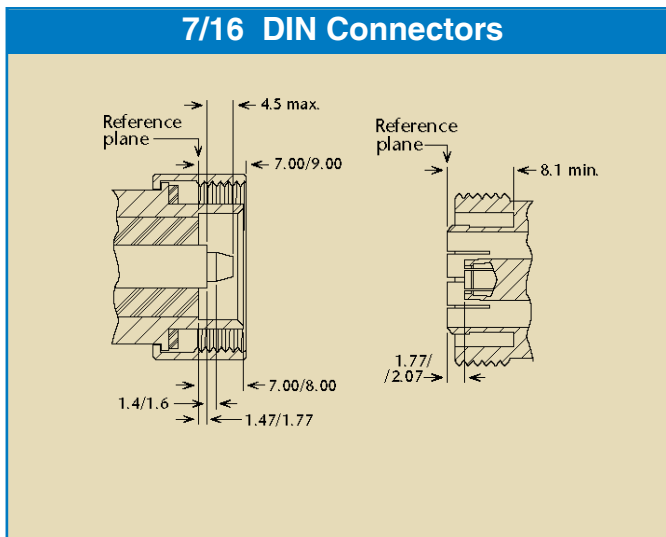
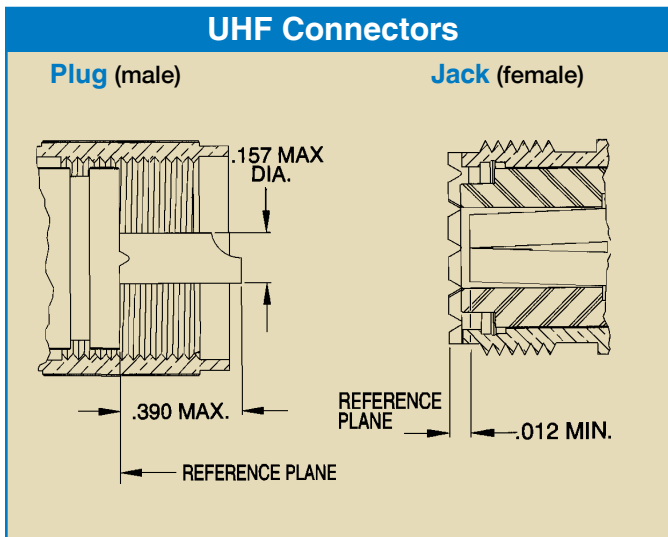
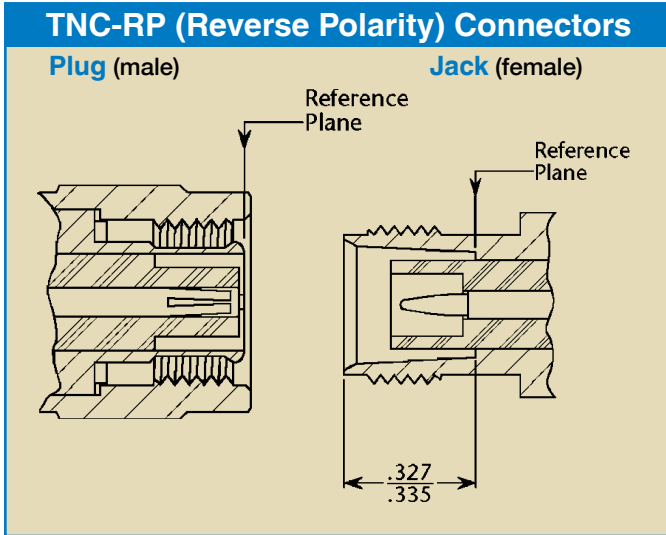
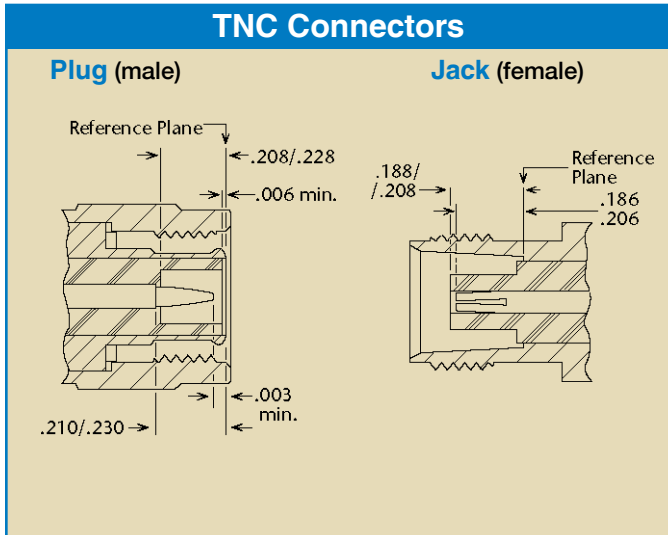

## Materials Abbreviations Legend

### CONDUCTORS & BRAID MATERIALS

AL	.....	Aluminum
BC	.....	Bare Copper
BeCu	.....	Beryllium-Copper Alloy 172
BCCAI	.....	Bare Copper Clad Aluminum
CCS	.....	Bare Copper Clad Steel
GS	.....	Galvanized Steel
HR	.....	High Resistance Wire
MW	.....	Magnet Wire
NC	.....	Nickel Covered Copper
SA	.....	Silver Covered Alloy
SC	.....	Silver Covered Copper
SCBeCu	.....	Silver Covered Beryllium Copper
SCCadBr	.....	Silver Covered Cadmium Bronze
SCCAI	.....	Silver Covered Copper Clad Aluminum
SCCS	.....	Silver Covered Copper Clad Steel
SNCCS	.....	Silver Covered Nickel Covered Copper Clad Steel
SCS	.....	Silver Covered Copper Strip
TC	.....	Tinned Copper
TCCS	.....	Tinned Copper Clad Steel

### DIELECTRIC MATERIALS

PE	.....	Solid Low Density Polyethylene
PTFE	.....	Solid Polytetrafluoroethylene
LDTFE	.....	Low Density PTFE
Foam PE	.....	Gas Injected Foam PE
FEP	.....	Solid Fluorinated Ethylene Propylene
CPT	.....	Conductive PTFE
CPE	.....	Conductive Polyethylene (Type A-5 per MIL-C-17)
Rubber	.....	per MIL-C-17 (obsolete)
MGO	.....	Magnesium Oxide (MgO)

### INTERLAYER MATERIALS

PE	.....	Solid Polyethylene
PTFE	.....	Solid Polytetrafluoroethylene
MY	.....	Polyester
KP	.....	Polyimide
ALMY	.....	Aluminum-Polyester Laminate
ALKP	.....	Aluminum-Polyimide Laminate
CPC	.....	Copper-Polyester-Copper Laminate

### JACKET MATERIALS

E-CTFE	.....	Ethylene Chlorotrifluoroethylene Type XI per MIL-C-17
ETFE	.....	Ethylene Tetrafluoroethylene Copolymer Type X per MIL-C-17
FEP	.....	Fluorinated Ethylene Propylene Type IX per MIN-C-17
FG Braid	.....	Fiberglass; Impregnated Type V per MIL-C-17
PE	.....	Clear Polyethylene Type III per MIL-C-17
LS/LT	.....	Low Smoke/Low Toxicity (XLPE)
PE	.....	Polyethylene, black HMW Type IIIA per MIL-C-17
PFA	.....	Perfluoroalkoxy Type XIII per MIL-C-17
PTFE	.....	Polytetrafluoroethylene Type VIIA per MIL-C-17
PUR	.....	Polyurethane, black Type XII per MIL-C-17
PVC-I	.....	Polyvinyl Chloride, black (contaminating) Type 1 per MIL-C-17
PVC-II	.....	Polyvinyl Chloride, grey (non-contaminating) Type II per MIL-C-17
PVC-IIA	.....	Polyvinyl Chloride, black (non-contaminating) Type IIA per MIL-C-17
Rubber	.....	Per MIL-C-17 (obsolete)
SIL/DAC	.....	Dacron Braid over Silicone Rubber Type VI per MIL-C-17
TPE	.....	Thermo Plastic Elastomer
XLPE	.....	Crosslinked Polyolefin Type XIV per MIL-C-17

## Coaxial Cable Equations Legend

Symbol	Definition	Units	Symbol	Definition	Units
$\alpha$	= Attenuation in dB/100 feet	dB/100 feet	<b>Fco</b>	= Cutoff frequency	GHz
$\epsilon$	= Dielectric constant		<b>C</b>	= Braid carriers	
$\Gamma$	= Reflection coefficient		<b>N</b>	= Braid ends per carrier	
$\phi$	= Electrical length	degrees	<b>t</b>	= Flat strip thickness	inches
<b>C</b>	= capacitance	pF/foot	<b>w</b>	= Flat strip width	inches
<b>L</b>	= Inductance	uH/foot	<b>SRL</b>	= Return loss	dB
<b>Zo</b>	= Impedance	ohms	<b>VSWR</b>	= Voltage standing wave ratio	
<b>Vp</b>	= Velocity of propagation	%	<b>FWD</b>	= Forward power	dB
<b>df</b>	= Dissipation factor		<b>RFL</b>	= Reflected power	dB
<b>Td</b>	= Time delay	nS/foot	<b>MML</b>	= Mismatch loss	dB
<b>F</b>	= Frequency	MHz	<b>ME</b>	= Match efficiency	%
<b>PTC</b>	= Phase temperature coefficient	ppm/C	<b>ks</b>	= 1.0 for solid center conductor	
$\Delta T$	= Change in temperature (t2 t0 t1)	C		= 0.939 for 7 strand center conductor	
<b>LTH</b>	= Length	feet		= 0.97 for 19 strand center conductor	
$\Delta\phi$	= Change in electrical length (t1 to t2)	degrees	<b>log</b>	= logarithm to base 10	
<b>D</b>	= dielectric diameter	inches	<b>ln</b>	= logarithm to base e	
<b>d</b>	= center conductor diameter	inches	<b>k1</b>	= resistive loss constant	
<b>ds</b>	= Braid wire size	inches	<b>k2</b>	= dielectric loss constant	
<b>Fbd</b>	= Braid factor				



## 3190 Connector Part Numbering Guide

**Attachment - Cable - Interface - Angle - Configuration - Finish - Impedance - Series Suffix**  
**(1) ----- (2) -----(3) ----- (4) ----- (5) -----(6) ----- (7) ----- (8)**

Note: All part numbers must include at the very least, include items (1), (2) and (3)

e.g. EZ-400-NMH-RA-X  
 TC-240-NF-PM-X  
 TC-SPP250-NF-BH-LP  
 TC-240-SM-RA-SS-X

**(1) Attachment:**

- TC** Crimp outer contact attachment and solder-on center-pin
- SC** Economic TC version
- EZ** Crimp outer contact attachment and captivated spring-finger center pin
- SZ** Economic EZ version

**(2) Cable Type:**

- XXX** Indicates corresponding LMR or TCOM cable (e.g. LMR-400 is -400)
- SWXXX** Indicates low PIM smooth wall cable
- YYYXXX** Indicates non-smooth wall low PIM cable (e.g. SPP-250-LLPL is SPP250)
- XXXT** Indicates corresponding SFT cable (e.g. SFT-205T)

**(3) Interface: (connectors are crimp style unless otherwise noted (see Notes))**

- 41M**---4.1/9.5 mini DIN male
- 41F**---4.1/9.5 mini DIN female
- 43M**---4.3/10.0 mini DIN male
- 43F**---4.3/10.0 mini DIN female
- 716M**---7/16 DIN male
- 716F**---7/16 DIN female
- 78EIA**---7/8 EIA flange (non-gender specific)
- 158EIA**---1 5/8 EIA flange (non-gender specific)
- BM**---BNC male
- BF**---BNC female
- FM**---F male
- HN**M---HN male
- LC**M---LC male
- MUHF**---mini UHF male
- NM**---N male
- NF**---N female
- QDSM**---QDS male
- QDSF**---QDS female
- QM**---QMA male
- QF**---QMA female

Notes:

The Interface code may be followed by one of the following letters/codes.

“H” - Indicates hex coupling nut on a type N interface

“C” - Indicates a clamp outer attachment

“K” – Indicates a knurled coupling nut on a type N interface

Note: All clamp style connectors must have the “C”

**QNM**----QN male  
**QNF**----QN female  
**SM**----SMA male  
**SF**----SMA female  
**TM**----TNC male  
**TF**----TNC female  
**UM**----UHF male

---

**(4) Angle:**

No code indicates straight

**RA**----Indicates a 90 degree right angle

---

**(5) Configuration:**

**BH**----bulkhead

**CL**----clam-shell clamp

**LP**----low PIM

**LW**----lockwire holes

**PM**----panel mount

**RP**----reverse polarity

**RT**----reverse thread

**-2**----two piece clamp

**SP**----some special characteristic

**PL**---plenum designation when used with LMR cables

**IP**----IP-67 rated in an unmated condition

---

Note: When more than two of the features listed under Configuration are called out, always list them in alphabetical order.

**(6) Finish:**

**-(A)**----Alballoy (no longer used for new part numbers. Alballoy is the default plating)

**-(Ni)**----Nickel

**-SS**----Stainless Steel

**Note:** Plating/Finish is not always called out in the part #

---

**(7) Impedance:**

No code indicates 50 ohms

**-75**-----75 ohms

---

**(8) Series Suffix:**

**-D**----Indicates the “Advantage” series (hex-knurl nut, Alballoy plating, ribbed back **end**)

**-X**----Indicates the “Advantage Plus” series (hex-knurl nut, Alballoy plating, ribbed back end, no braid trim)

## Coax Cable Design Equations

### Impedance (ohms)

$$Z_0 = 138 V_p \log \left( \frac{D}{d \cdot k_s} \right) = 60 V_p \ln \left( \frac{D}{d \cdot k_s} \right)$$

$$Z_0 = \frac{138}{\sqrt{\epsilon}} \log \left( \frac{D}{d \cdot k_s} \right) = \frac{60}{\sqrt{\epsilon}} \ln \left( \frac{D}{d \cdot k_s} \right)$$

$$Z_0 = \sqrt{L/C}$$

### Velocity of Propagation and Dielectric Constant

$$V_P = \frac{1}{\sqrt{\epsilon}} = \frac{1}{V_P^2}$$

### Time Delay (nS/foot)

$$T_d = \frac{1.016}{V_P} = 1.016 \sqrt{\epsilon}$$

### Capacitance (pF/foot)

$$C = \frac{7.36 \epsilon}{\log \left( \frac{D}{d \cdot k_s} \right)} = \frac{16.95 \epsilon}{\ln \left( \frac{D}{d \cdot k_s} \right)}$$

$$C = \frac{7.36}{V_P^2 \log \left( \frac{D}{d \cdot k_s} \right)} = \frac{16.95}{V_P^2 \ln \left( \frac{D}{d \cdot k_s} \right)}$$

$$C = \frac{1016}{Z_0 \cdot V_P}$$

### Inductance (uH/foot)

$$L = .140 \log \left( \frac{D}{d \cdot k_s} \right) = .0606 \ln \left( \frac{D}{d \cdot k_s} \right)$$

$$L = \frac{Z_0^2 \cdot C}{1 \times 10^6}$$

### Attenuation (dB/foot)

$$\alpha = \frac{.4343}{Z_0 \cdot D} \left[ \frac{D}{d \cdot k_s} + F_{bd} \right] \sqrt{F} + \frac{2.78 \cdot df \cdot F}{V_P}$$

$$\alpha = k_1 \sqrt{F} + k_2 F$$

### Braid Factor

Round Wire Braid:  $F_{bd} = \frac{8D + 16 ds}{C \cdot N \cdot ds}$

Flat Strip Braid:  $F_{bd} = \frac{2\pi (D + 2t)}{C \cdot W}$

Solid Tube:  $F_{bd} = 1.0$

### Cutoff Frequency (GHz)

$$F_{co} = \frac{7.5 \cdot V_p}{(D + (d \cdot k_s))}$$

$$F_{co} = \frac{7.5}{\sqrt{\epsilon} (D + (d \cdot k_s))}$$

### Electrical Length (degrees)

$$\Phi = \frac{360 \cdot F \cdot L_{TH}}{984 \cdot V_p}$$

$$\Phi = \frac{360 \cdot F \cdot L_{TH} \cdot \sqrt{\epsilon}}{984}$$

### Phase Temperature Coefficient (ppm/C°)

$$PTC = \frac{\Delta \Phi \cdot 1 \times 10^6}{\Phi \cdot \Delta T}$$

### Phase Stability (degrees)

$$\Delta \Phi = \frac{PTC \cdot \Phi \cdot \Delta T}{1 \times 10^6}$$

### Return Loss (dB)

$$RL = -20 \log \Gamma$$

$$RL = -20 \log \frac{VSWR-1}{VSWR+1}$$

$$RL = -10 \log \frac{RFL}{FWD}$$

### VSWR

$$VSWR = \frac{1 + \Gamma}{1 - \Gamma}$$

$$VSWR = \frac{1 + 10^{RL/20}}{1 - 10^{RL/20}}$$

$$VSWR = \frac{1 + \sqrt{RFL/FWD}}{1 - \sqrt{RFL/FWD}}$$

### Reflection Coefficient

$$\Gamma = 10^{-RL/20}$$

$$\Gamma = \frac{VSWR - 1}{VSWR + 1}$$

$$\Gamma = \sqrt{RFL/FWD}$$

### Match Efficiency (%)

$$ME = (1 - \Gamma^2) \cdot 100$$

$$ME = \left[ 1 - \left( \frac{VSWR - 1}{VSWR + 1} \right)^2 \right] \cdot 100$$

$$ME = \left( \frac{FWD - REL}{FWD} \right) \cdot 100$$

### Match Efficiency (%)

$$MML = -10 \log (1 - \Gamma^2)$$

$$MML = -10 \log \left[ 1 - \left( \frac{VSWR - 1}{VSWR + 1} \right)^2 \right]$$

$$MML = -10 \log \left( 1 - \frac{RFL}{FWD} \right)$$

## General Electrical Properties

	Cable Type	Impedance (ohms)	Capacitance (pF/foot)	Velocity (%)	Dielectric Constant	Time Delay (nS/foot)
<b>50 OHM</b>	Solid Polyethylene	50	30.8	65.9	2.30	1.54
	Foam PE	50	24.5	83.0	1.45	1.22
	Foam PE	50	24.2	84.0	1.42	1.21
	Foam PE	50	23.9	85.0	1.38	1.20
	Foam PE	50	23.6	86.0	1.35	1.18
	Foam PE	50	23.3	87.0	1.32	1.17
	Foam PE	50	23.1	88.0	1.29	1.16
	Solid PTFE	50	29.2	69.5	2.07	1.46
	Tape PTFE	50	28.6	71.0	1.98	1.43
	Low Density PTFE	50	26.7	76.0	1.73	1.34
	Low Density PTFE	50	25.4	80.0	1.56	1.27
<b>75 OHM</b>	Solid Polyethylene	75	20.6	65.9	2.30	1.54
	Foam PE	75	16.3	83.0	1.45	1.22
	Foam PE	75	16.1	84.0	1.42	1.21
	Foam PE	75	15.9	85.0	1.38	1.20
	Foam PE	75	15.8	86.0	1.35	1.18
	Foam PE	75	15.6	87.0	1.32	1.17
	Foam PE	75	15.4	88.0	1.29	1.16
	Solid PTFE	75	19.5	69.5	2.07	1.46
	Low Density PTFE	75	17.8	76.0	1.73	1.34
	Low Density PTFE	75	16.9	80.0	1.56	1.27
	<b>MISC</b>	Solid Polyethylene	95	16.2	65.9	2.30
Foam PE		95	12.6	85.0	1.38	1.20
Air Spaced PE		95	12.6	85.0	1.38	1.20
Solid PTFE		95	15.4	69.5	2.07	1.46
Air Spaced PE		125	09.6	85.0	1.38	1.20
Air Spaced PE		185	06.5	85.0	1.38	1.20

## Properties of Wire and Cable Insulating Materials

Material	Dielectric Constant	Dissipation Factor	Volume-Resistivity (ohm-cm)	Operating Temperature (Range °C)
PTFE	2.07	0.0003	$10^{19}$ th	-75 to +250
Polyethylene	2.3	0.0003	$10^{16}$ th	-65 to +80
Foam Polyethylene	1.29 - 1.64	0.0001	$10^{12}$ th	-65 to +100
Polyvinylchloride	3.0 - 8.0	0.07 - 0.16	$2 \times 10^{12}$ th	-50 to +105
Polyamide	3.5 - 4.6	0.03 - 0.4	$4 \times 10^{14}$ th	-60 to +120
Silicone Rubber	2.1 - 3.5	0.007 - 0.016	$10^{13}$ th	-70 to +250
Ethylene Propylene	2.24	0.00046	$10^{17}$ th	-40 to +105
FEP	2.1	0.0007	$10^{18}$ th	-70 to +200
Low Density PTFE	1.38 - 1.73	0.00005	$10^{19}$ th	-75 to +250
Foam FEP	1.45	0.0007	$10^{18}$ th	-75 to +200
Polyimide	3.0 - 3.5	0.002 - 0.003	$10^{13}$ th	-75 to +300
PFA	2.1	0.001	$10^{16}$ th	-75 to +260
ETFE	2.6	0.005	$10^{16}$ th	-75 to +150
ECTFE	2.5	0.0015	$10^{16}$ th	-65 to +150
PVDF	7.8	0.02	$10^{14}$ th	-75 to +125

## A guide to the selection of RF coaxial cable

Choosing the best coaxial cable for a new application requires an understanding of the application and of the range of cables to choose from. The best choice can only be arrived at by a careful evaluation of the performance and cost trade-offs. Our in-depth expertise in all aspects of coaxial cable technology can help you to arrive at the best choice for your application.

Times Microwave Systems offers the broadest range of coaxial cables of any manufacturer. We also have the expertise to design and produce custom cables if there is no design available for your application.

In choosing the best coaxial cable for an application, the cable characteristics listed below should be considered. The following sections provide detailed discussions of each characteristic.

- A:** Characteristic Impedance
- B:** VSWR & Impedance Uniformity
- C:** Attenuation
  - Attenuation Uniformity
  - Attenuation Stability
- D:** Power Rating
- E:** Operating Voltage
- F:** Shielding
- G:** Capacitance
- H:** Velocity of Propagation
- I:** Electrical Length Stability
- J:** Cut-Off Frequency
- K:** Pulse Response
- L:** Self-Generated Cable Noise
- M:** Operating Temperature Range
- N:** Flexibility
- O:** Environmental Resistance
- P:** Cable Strength
- Q:** Qualification & U L Approval

Table 1 provides various formulae describing cable characteristics.

### A. CHARACTERISTIC IMPEDANCE

The characteristic impedance of a coaxial cable is determined by the ratio of the diameter of the outer conductor to the inner conductor and the dielectric

Fig. 1  
VSWR vs. Frequency

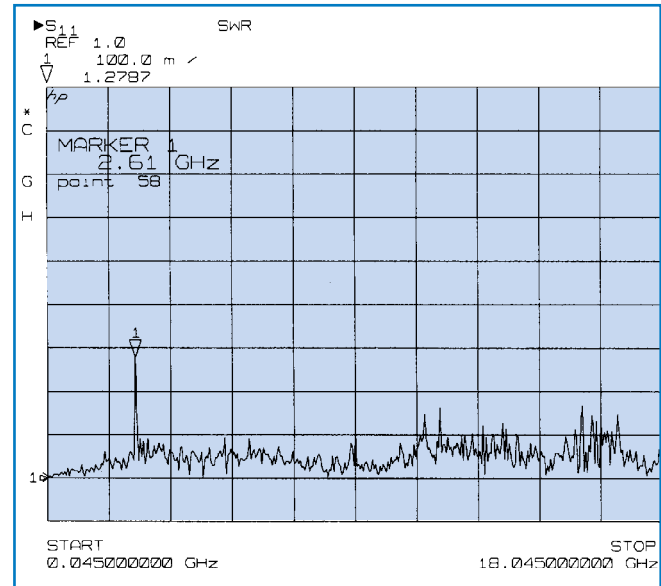

constant of the insulating material between the conductors. Because the RF energy in the cable travels on the surface of the conductors, the important diameters are the outside diameter of the center conductor and the inside diameter of the outer conductor. Impedance is selected to match the system requirements.

The most common coaxial cables impedances are 50, 75, and 95 ohm. Other impedances from 35 to 185 ohms are sometimes used. Fifty ohm cables are used in microwave and wireless communications applications. Seventy-five ohm cables are typically used in cable television applications and video applications. Ninety-five ohm cables are typically used for data transmission applications.

For best system performance, the cable must be selected to match the impedance of the other components in the system. Of the most commonly used coaxial cables, 75 ohms impedance provides the lowest attenuation and 35 ohms impedance provides the best power handling. For practical cables with non-ideal dielectrics and conductors, these differences are small. The availability of required

components and cables with the appropriate characteristic impedance is usually the prime factor in selecting a given system impedance.

### B. SIGNAL REFLECTION: VSWR, RETURN LOSS, REFLECTION FACTOR & IMPEDANCE UNIFORMITY

There are three things that happen to RF energy input into a coaxial cable assembly:

1. It is transmitted to the other end of the cable, as is usually desired.
2. It is lost along the length of the cable either by being transformed into heat or by leaking out of the cable.
3. It is reflected back towards the input end of the cable.

Reflections back towards the input end of the cable are caused by variations in impedance along the length of the cable assembly. This includes differences in impedance between the cable and the devices to which it is attached. Typically the connectors and the interface between the connectors and the cable will be major contributors to the reflection. The cable itself can also contribute to the reflections. One source of cable reflections is periodic variations in impedance which result from the manufacturing process and add up at a specific frequency. When viewed in a sweep over a range of frequencies this will show up as a spike. An example of a spike is shown in Figure 1.

The magnitude of a reflection can be expressed in several ways. Perhaps the most familiar is VSWR or Voltage Standing Wave Ratio. A value of 1.0:1 or just 1.0 indicates no reflected power or a perfect cable. Alternatively, the reflection can be expressed as return loss—the ratio of the reflected power to the input power usually expressed in decibels. Table 1 gives the formulas to convert between VSWR, return loss and reflection coefficient. A tabulation of the equivalent values of all three measures is also provided in Table 2.

The lack of reflected power (or low VSWR) is often used as a figure of merit for coaxial components, including cables, connectors and cable assemblies. It is indicative of how well the uniformity of the cable is

Table 2  
VSWR Conversions

VSWR (:1)	Return Loss (dB)	Reflection Coefficient	Mismatch Loss (dB)	Match Efficiency (%)
1.011	45	0.006	0.000	100.00
1.020	40	0.010	0.000	99.99
1.036	35	0.018	0.001	99.97
1.065	30	0.032	0.004	99.90
1.074	29	0.035	0.005	99.87
1.08	28	0.400	0.007	99.84
1.09	27	0.045	0.009	99.80
1.11	26	0.050	0.011	99.75
1.12	25	0.056	0.014	99.68
1.13	24	0.063	0.017	99.60
1.15	23	0.071	0.022	99.50
1.17	22	0.079	0.027	99.37
1.20	21	0.089	0.035	99.21
1.22	20	0.100	0.044	99.00
1.25	19	0.112	0.055	98.74
1.29	18	0.126	0.069	98.42
1.33	17	0.141	0.088	98.00
1.38	16	0.158	0.110	97.49
1.43	15	0.178	0.140	96.84
1.50	14	0.200	0.176	96.02
1.58	13	0.224	0.223	94.99
1.67	12	0.251	0.283	93.69
1.78	11	0.282	0.359	92.06
1.92	10	0.316	0.458	90.00
2.10	9	0.355	0.584	87.41
2.32	8	0.398	0.749	84.15
2.61	7	0.447	0.967	80.05
3.01	6	0.501	1.256	74.88
3.57	5	0.562	1.651	68.38
4.42	4	0.631	2.205	60.19
5.85	3	0.708	3.021	49.88

Match efficiency - e.g. 100 Watts Forward Power at 1.33:1 VSWR yields 98 Watts Output (i.e. 2 Watts Reflected)

## A guide to the selection of RF coaxial cable

maintained along its length, whether the connectors are properly designed and attached and how well the transitions between line sizes are compensated for in the connectors. It is generally a function of frequency, with reflections generally getting higher as the frequency increases.

In many applications, low reflected power is critical for proper system performance. In these cases, it is essential that this be considered in the selection of the cable and connectors. In addition, care must be taken to properly attach the connectors to the cable in order to achieve the proper results. Purchase of completed, factory assembled and tested cable assemblies should be considered for VSWR critical applications.

Note that actual input impedance at a particular frequency may be quite different from the characteristic impedance of the cable due to reflections in the line. The Voltage Standing Wave Ratio (or VSWR) of a particular length of cable is an indicator of the difference between the actual input impedance of the cable and its average characteristic impedance.

Fig. 2  
Attenuation Temperature  
Correction Factor

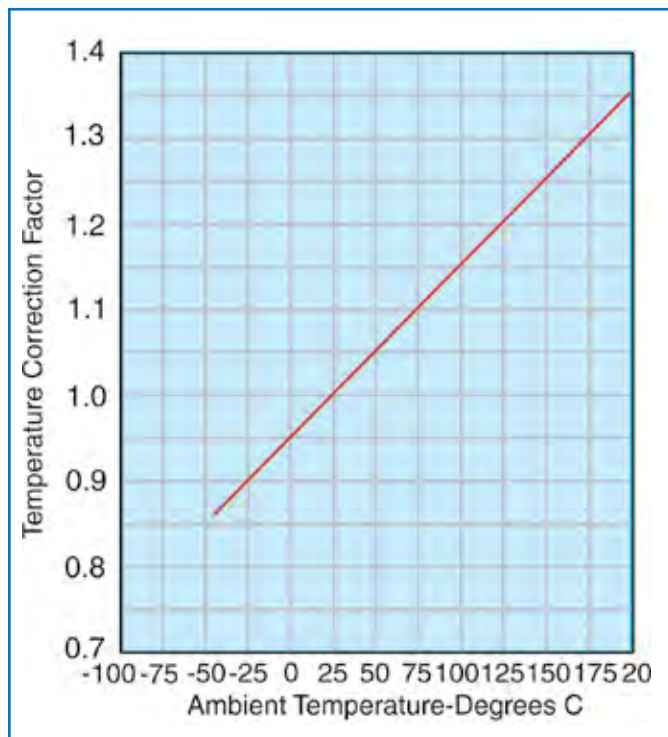
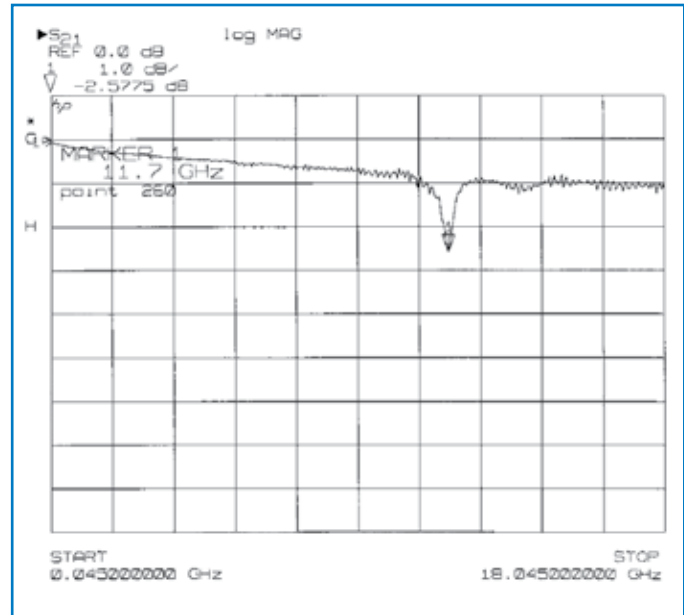

Fig. 3  
Attenuation vs. Frequency



The impedance of long lengths of cable will exhibit very little change over their operating temperature ranges - less than 2%.

It is possible to fabricate cables having a characteristic impedance that varies through the length of the cable for matching purposes. Thus a coaxial cable can be used as a broadband impedance transformer to match differing source and load impedances. The transforming action is related to cable length and the minimum operating frequency, and the cable must be designed for the specific application.

### C. ATTENUATION

Attenuation is the loss of signal along the length of a cable. As the RF signal passes through the cable, a portion of the signal is converted to heat and a portion of the signal leaks out of the cable through the outer conductor. This loss of signal is usually expressed in decibels per unit of length at a specific frequency, since attenuation increases with frequency.

For most applications, the objective is to minimize the losses in the cable runs or to stay within a loss budget. Minimum loss corresponds to an attenuation of 0 dB or a ratio of 1 to 1 between input and output power. Because cable losses decrease with increasing

cable diameter for the same type of construction, minimizing cable loss means maximizing cable size.

Attenuation is determined by the conductive and dielectric losses of the cable. Larger cables have lower conductor losses, reducing attenuation. Dielectric loss is independent of size. Dielectric losses increase linearly with frequency, while conductor losses increase with the square root of frequency. Therefore, dielectric losses become a larger proportion of the total cable loss as frequency increases.

Attenuation must be modified by a correction factor for the ambient temperature (see Figure 2). Elevated temperature increases cable attenuation by increasing the resistance of the conductors and by increasing the power factor of the dielectric (see Figure 6 for correction factors).

To select a cable construction for a particular application, determine the desired attenuation at the highest frequency from system requirements. Determine the corrected attenuation by dividing the desired attenuation by the temperature correction

Fig. 4  
Attenuation vs. Flexure

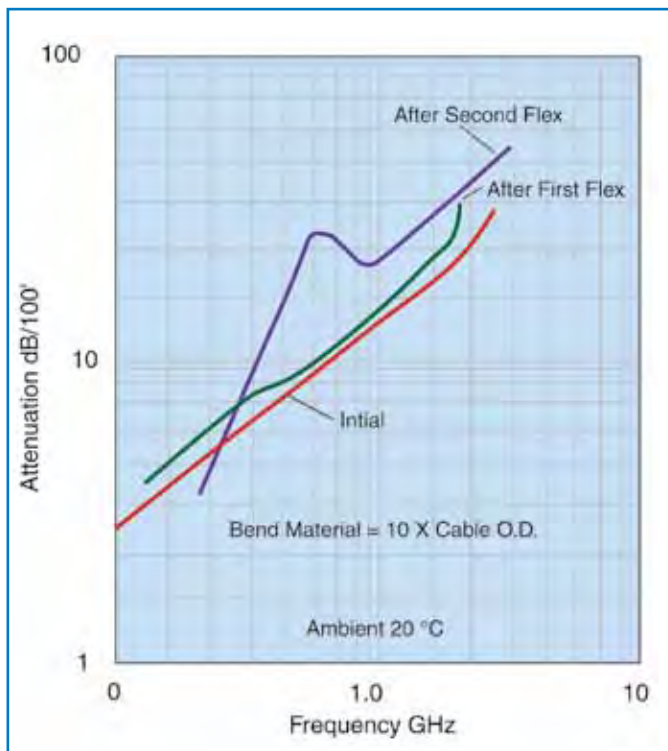
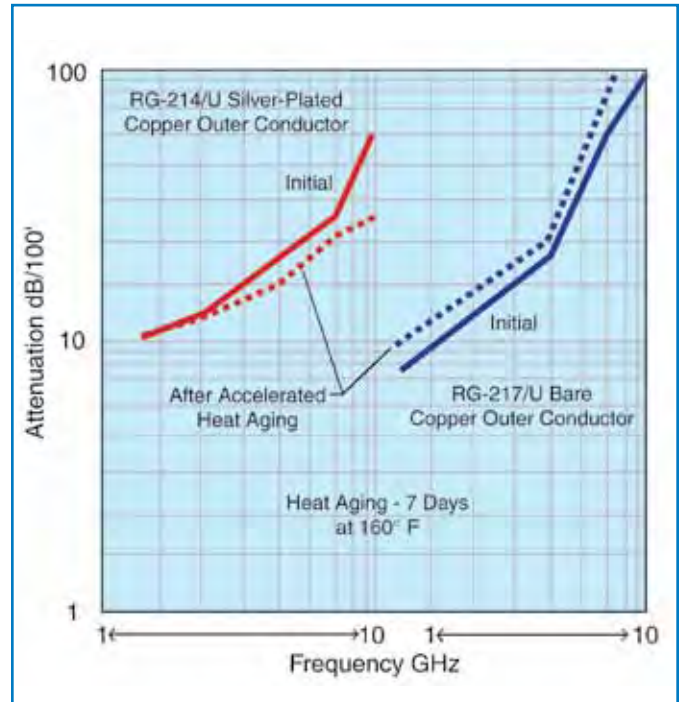

Fig. 5  
Attenuation Stability



factor. Choose the smallest cable meeting the corrected attenuation value from the tables.

For cables with low attenuation for their size, see the LMR, StripFlex, SFT, and CLL families of cables.

### Attenuation Uniformity

The attenuation of any cable may not change uniformly as the frequency changes. Random and periodic impedance variations give rise to random and periodic attenuation responses. Narrow-band attenuation “spikes” such as that shown in Figure 3 can occur. If required, cables can be procured in various lengths where a maximum attenuation variation from nominal is specified over a customer defined frequency range.

### Attenuation Stability

The attenuation of braided cables can increase with time and flexure. The change with time can be caused by corrosion of the braided shield, by contamination of the primary insulation due to jacket plasticizers, and by moisture penetration through the jacket. These



## A guide to the selection of RF coaxial cable

effects can be essentially eliminated by encapsulating the braid with an appropriate flooding compound, as is done in the DB versions of the LMR cables. (Vapor penetration occurs at differing rates through all plastic and elastomeric materials.) Attenuation degradation is more pronounced at frequencies above 1 GHz. Cables having bare copper and tinned copper braids exhibit far greater attenuation degradation than cables with silver plated braids. These effects are illustrated in Figure 5.

The following guidelines apply:

**a. Tin plated braids:** Below 1 GHz, cables manufactured with tin plated braids have 15-20% more attenuation than bare copper braids in the “as manufactured” condition, but are more stable than bare copper braided cables.

**b. Foam polyethylene:** Flexible braided cables with foam polyethylene dielectrics have approximately 15 to 40% lower attenuation than solid polyethylene cables

Fig. 6

Power Temperature Correction Factor

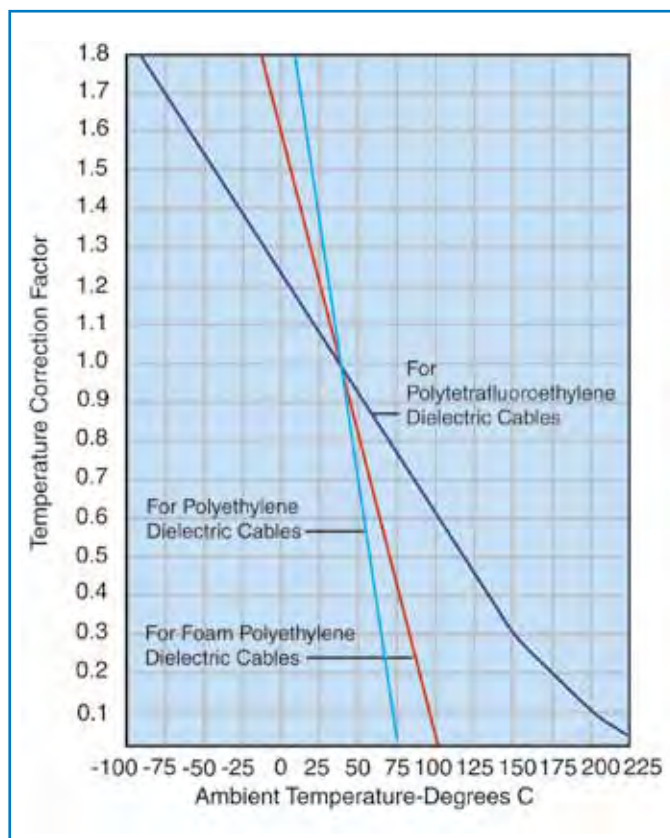
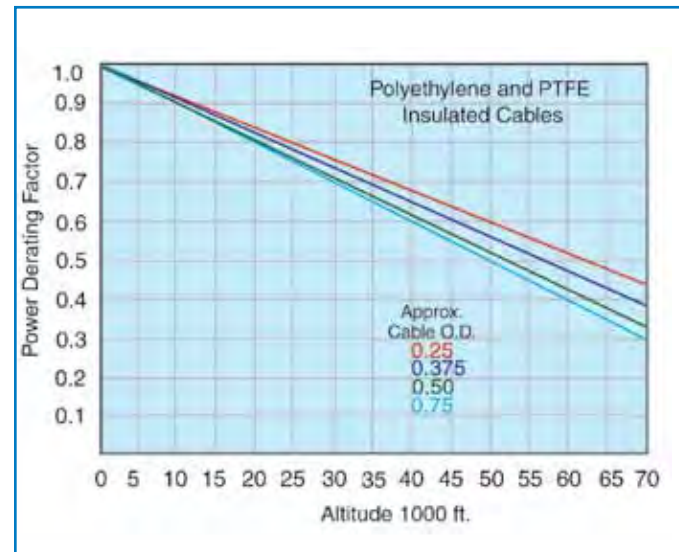

Fig. 7

Power Altitude Correction Factor



of the same core size and impedance. However, some polyethylene foams can absorb moisture causing attenuation increases. LMR cables utilize a closed cell, non-hydroscopic foam composition and are not subject to this problem.

See LMR cables.

**c.** If PVC jackets are used, a Type IIA, non-contaminating PVC should be specified for applications where attenuation uniformity over time is important. Type I PVC's contain plasticizers which can leach into the dielectric over time causing an increase in attenuation.

**d.** The ultimate in attenuation stability can be achieved by specifying hermetically-sealed cable assemblies. These will preclude the ingress of contaminants of any sort into the cable and result in the best stability, such as MilTech assemblies. Contact Times Microwave for more information on this type of assembly.

For flexible cables in extreme environmental conditions, a protected braid (e.g. LMR-DB) is recommended.

### D. AVERAGE POWER RATING

Electrical losses in a coaxial cable result in the generation of heat in the center and outer conductors, as well as in the dielectric core. The power handling

Fig. 8  
Second VSWR  
Correction Factor Multiplier K

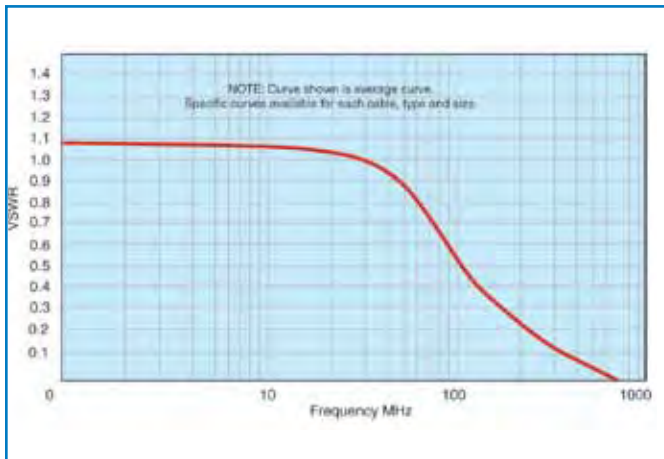

capability of a cable is related to the ability of the cable to dissipate this heat. The ultimate limiting factor in power handling is the maximum allowable operating temperature of the materials used in the cable, especially the dielectric. This is because most of the heat is generated at the center conductor of the cable. In general, the power handling capability of a given cable is inversely proportional to its attenuation, and directly related to its size. The other factor is the heat transfer properties of the cable, especially the dielectric.

Cable power ratings must be derated by correction factors for the ambient temperature, altitude and VSWR encountered in a particular application. High ambient temperature and high altitude reduce the power rating of a cable by impeding heat transfer out of the cable. VSWR reduces power rating by causing localized hot spots in the cable.

To select the cable construction for a particular requirement, determine the average input power at the highest frequency from system requirements. Then determine the effective average input power as follows:

$$\text{Effective Power} = \frac{\text{Average Power} \times (\text{VSWR correction})}{(\text{Temp. correction}) \times (\text{Alt. correction})}$$

Temperature and altitude corrections are shown on Figures 6 and 7.

VSWR correction factor =

$$\frac{1}{2} (\text{VSWR} + \frac{1}{\text{VSWR}}) + \frac{1}{2} k_1 (\text{VSWR} - \frac{1}{\text{VSWR}})$$

Where k, is shown in Figure 8. Select a cable from the Attenuation and Power charts rated at this effective power level.

Note that the peak power handling capability of a cable is related to the maximum operating voltage rating. See Section E, below.

### E. MAXIMUM OPERATING VOLTAGE

Care must be taken to ensure that the continuous voltage (and the peak voltage related to pulsed power conditions) applied to a cable is held below its maximum voltage rating. Note that there are two separate voltage ratings for a cable: Corona Voltage and Dielectric Withstanding Voltage:

1. Corona is a voltage related ionization phenomenon which causes noise generation, long term dielectric damage, and eventual breakdown of the cable. Thus, a cable cannot operate continuously with corona, and the maximum operating voltage must be less than the corona extinction level (extinction voltage) of the cable. The determination of corona voltages requires sensitive instrumentation capable of detecting the voltage induced ionization noise generation.

2. The Dielectric Withstanding Voltage, or dielectric strength of the cable, is a measure of the voltage level required to abruptly break down the dielectric employed in a cable. DWV testing requires less sensitive instrumentation, and is a test measurement where a voltage is applied to the cable for a limited time only, and monitored for current flow.

Maximum operating A.C. (RMS) voltage levels or peak voltage are given for each construction in the Cable Data Section of this catalog. The maximum permissible D.C. voltage level is conservatively 3 times the A.C. level.

To select a cable for a particular application, determine the actual RMS (peak /1.4) ,

$$\text{RMS voltage} = \frac{(\text{peak voltage value})}{1.4}$$

## A guide to the selection of RF coaxial cable

Fig. 9  
Shielding Effectiveness

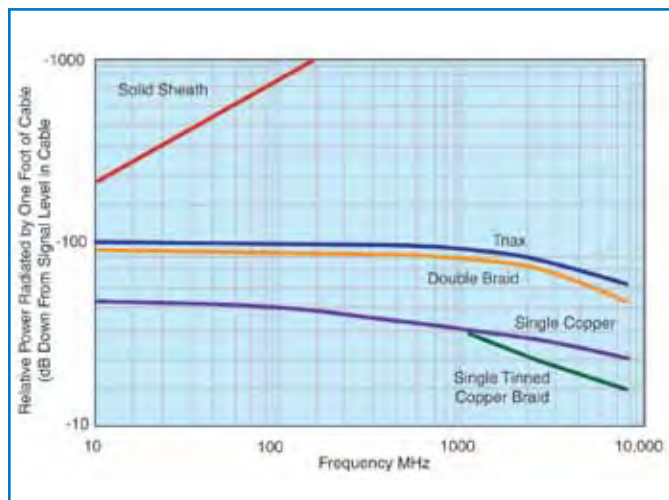

or actual peak voltage = (RMS x value 1.4)  
from system requirements. Then determine the effective input voltage by multiplying the actual input voltage by the square root of the VSWR:

$$\text{Effective voltage} = \text{Actual voltage} \times (\text{VSWR})^{1/2}$$

Then select a cable with a maximum operating voltage greater than the effective RMS voltage. Maximum operating voltages are listed in the cable data section.

As the altitude where a cable is being used increases, the maximum operating voltage of a completed cable assembly is reduced due to the reduction in dielectric strength of the lower pressure air in the termination area.

### F. SHIELDING AND CROSS-TALK (OR ISOLATION)

1. The shielding efficiency of a coaxial cable depends on the construction of its outer conductor. The most common constructions available are:

**Single Braid:** Consisting of bare, tinned, or silver plated round copper wires (70 to 95% coverage).

**Double Braid:** Consisting of two single braids as described above with no insulation between them.

**Triaxial:** Consisting of two single braids as described above with a layer of insulation between them.

**Strip Braids:** Consists of flat strips of copper rather

than round wires (90% coverage).

**Strip Outer Conductors/Spiral Flat Strips:** Exhibiting @ 100% coverage.

**Solid Sheath:** Consisting of aluminum or copper tubing (100% coverage).

2. The relative shielding effectiveness of these constructions are illustrated in Figure 9 over the frequency range from 10 MHz to 8 GHz. This graph shows the level of signal which leaks through the outer shield of a one foot sample of each construction. The curves describing the performance of the flexible cables, i.e., the triax braid, double braid, and single braid construction are based on measured data.

To estimate the total leakage in cables under 1100 ft. long, add  $20 \log L$  to the figure read from the graph (where L is the cable length in feet). The curve showing the typical performance of the semi-flexible (or solid sheath) cables is based on theory. In practice the shielding efficiency of interconnections made using semi-flexible (solid sheath) cables is limited by the leakage at the connectors.

3. The isolation (or cross talk) between two coax cable runs is the sum of the isolation factors of the two cables and the isolation due to the “coupling factor” between the runs. This coupling factor will depend on the relative spacing, positioning and environment of the cable runs and on the grounding practices employed. The coupling factor will substantially affect the isolation between the cable runs.

4. Measurements show that the RF(1 -30 MHz) cross

Fig. 10  
Phase Stability

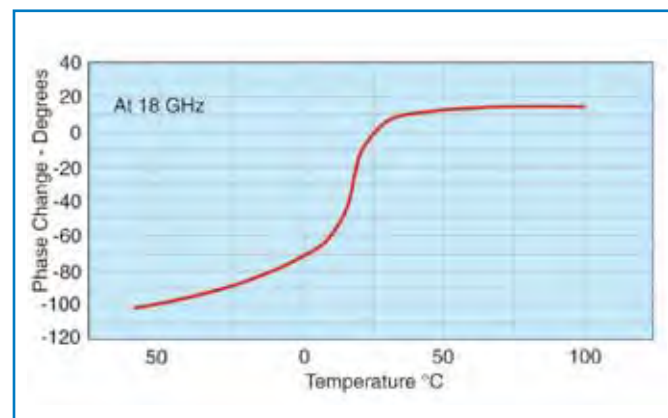
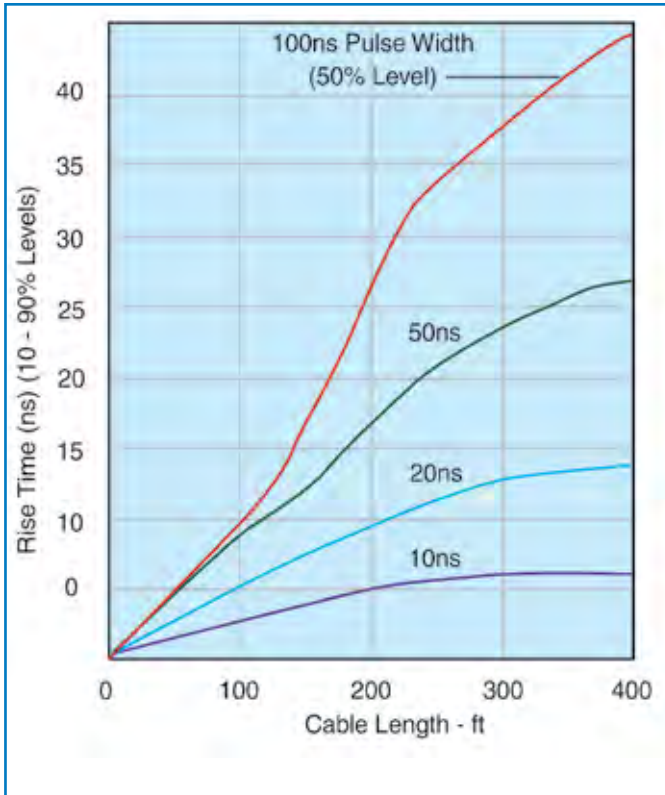

Fig. 11  
Pulse Distortion



talk between two single braided coaxes over a 20 foot run length is approximately 80 db down from the signal level inside the cables. The coaxes were laid side-by-side over the 20 foot test length. (This test data illustrates the affect of the “coupling factor” noted above.)

5. Special Constructions that provide enhanced shielding characteristics are available. These cables include the LMR, RD, and RDT families of cables, and the StripFlex, SFT, and TFlex cables.

**G. CAPACITANCE**

Capacitance in a cable is related to the dielectric material and the characteristic impedance. Typical capacitance values are shown in the General Electrical Properties on page 187 for some common coaxial lines.

As seen in the table, the higher impedance cables provide lower “capacitance per foot” values, resulting in reduced loading for data communications applications.

**H. VELOCITY OF PROPAGATION**

The velocity of propagation in a coaxial cable is determined primarily by the dielectric constant of the insulating material between the inner and outer conductors. This property is usually expressed as a percentage of the velocity of light in free space, and is typically noted as  $V_g$  or  $V_p$ .

The General Electrical Properties on page 182 shows the velocity of propagation and time delay of cables insulated with commonly used dielectrics.

Delay lines made from coaxial cable can sometimes benefit from using lower velocity cables, thus providing maximum delay in the shortest length. But, the difference in loss between the lower and higher velocity cables must also be taken into account.

**I. ELECTRICAL LENGTH STABILITY**

Applications such as antenna feed systems may require many cable assemblies that are trimmed to a specific electrical length. In these applications, the change of the electrical length of the cable with temperature, flexure, tension and other environmental factors is critical. The variation of electrical length with

Fig. 12  
Pulse Amplitude vs. Length

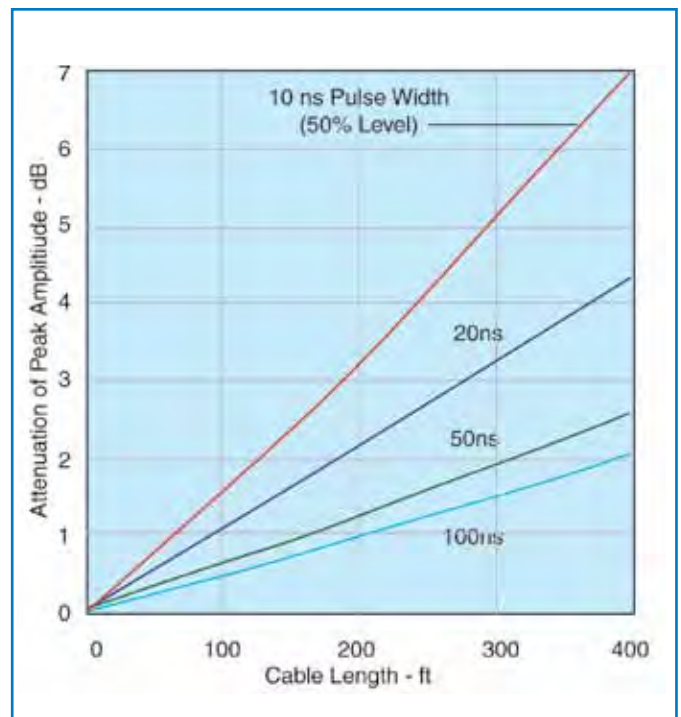

## A guide to the selection of RF coaxial cable

temperature for standard flexible cables is shown in Figure 10.

For polyethylene insulated cables: -100 to -250 parts per million/ $^{\circ}$ C.

For TFE insulated cables: -50 to -100 parts/million/ $^{\circ}$ C.

The variation of electrical length with temperature for the standard foam dielectric semiflexible cables is -20 to -30 parts/million/ $^{\circ}$ C.

Times has special flexible and semiflexible cable designs with improved electrical length versus temperature characteristics. Semiflexible cables having an electrical length change with temperature as low as five parts/million per degree centigrade are available. See SFT and Coppersol Low Loss CLL cables.

### J. CUT-OFF FREQUENCY

The cut-off frequency of a coaxial cable is that frequency at which modes of energy transmission other than the Transverse Electro-Magnetic (TEM) mode can be generated. It does not mean that the TEM mode becomes highly attenuated. This frequency is a function of the mean diameter of the conductors and the velocity of propagation of the cable. The higher modes are only generated at impedance discontinuities and in many situations the cable can be operated above the cut-off frequency without substantial VSWR or insertion loss increase. However, it is recommended that cables not be operated above their cut-off frequency.

### K. PULSE RESPONSE OF COAXIAL CABLES

1. The following characteristics must be considered when analyzing the Time Domain response of cable to pulses or step functions:

- a: Impedance and Reflection;
- b: Rise Time;
- c: Amplitude;
- d: Overshoot or Preshoot;
- e: Pulse Echoes.

#### a: Impedance and Reflection

1. Select impedance to match system requirements.
2. The impedance will vary along the length of cable. Variations of +5% are not uncommon. Cables can be

Fig. 13  
Step Response  
(Output Amplitude vs. Time)

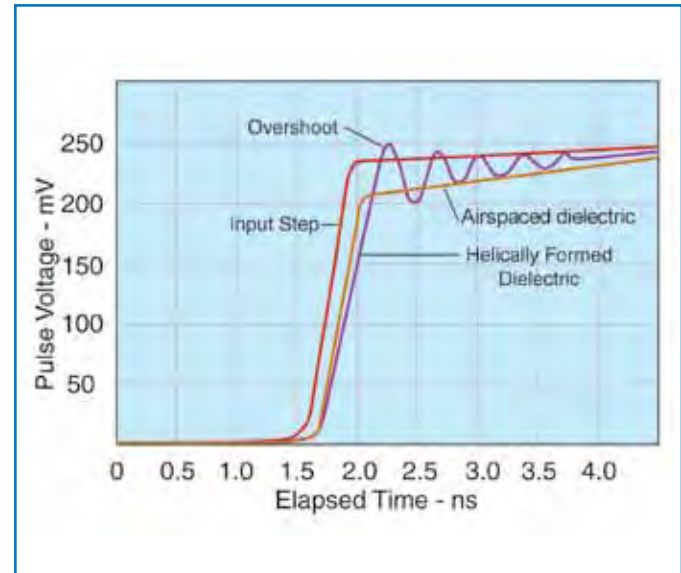

produced to tolerances of 2%. Tighter tolerances are not recommended.

#### b: & c: Rise Time and Amplitude

1. The output rise time is a function of input rise time, pulse width and cable attenuation. A typical pulse response is shown in Figures 11 and 12, while a typical step response is shown in Figure 13. Increased cable temperature causes an increase in rise time and decrease in amplitude.

#### d: Overshoot or Preshoot

1. Figure 13 shows the overshoot which can be encountered with a 0.1 ns input pulse rise time in cables due to finite reflections. Such overshoot is not common in cables with longitudinally extruded dielectrics.

2. Preshoot is encountered in some balanced delay lines and can be minimized by cable design.

#### e: Pulse Echoes

When a narrow pulse is placed on a cable, the distortions noted above will occur. In addition, a small pulse of energy may emerge after the initial pulse has arrived. This pulse echo is caused by finite periodic reflections within the cable. Normally the echo level can be neglected.

## L. SELF-GENERATED CABLE NOISE

A noted cable phenomenon, is the generation of acoustical and electrical noise when flexed. The acoustical noise is a function of mechanical motion within the cable. Such noise (and the associated mechanical and frictional force) is minimized by proper cable design. Electrical noise generation is attributed to an electrostatic effect, which in testing has exhibited more than 500 millivolts in RG cable. This noise voltage can be minimized by preventing motion between dielectrics and conductors or dissipating electrostatic charges between conductors and dielectrics with semiconducting layers. Low noise constructions must take into account the life expectancy and environmental conditions to which they are subjected. Times manufactures low noise cables for special applications.

## M. OPERATING TEMPERATURE RANGE

1. The operating temperature range of flexible coaxial cable is determined primarily by the operating temperature range of the dielectric and jacketing materials. Note that only silver plated conductors are suitable for long term use at temperatures over 80 degrees C.

2. Operating temperature limits of the most commonly used dielectrics and jacket types are given in the following table:

Material	Temperature Range
Polytetrafluoroethylene (PTFE)	-75°C to + 250°C
Polyethylene	-40°C to + 85°C
Foamed Polyethylene	- 40°C to + 100°C
Foamed or Solid Ethylene Propylene Jackets	- 40°C to + 105°C
Fluorinated Ethylene Propylene (FEP)	-70°C to +200°C
Polyvinylchloride (PVC)	- 40°C to + 85°C
Ethylene Chloro Trifluoroethylene (ECTFE)	- 65°C to + 150°C
Polyurethane	-100°C to + 125°C
Perfluoroalkoxy (PFA)	-65°C to + 260°C
Nylon	-60°C to + 120°C
Ethylene Propylene	- 40°C to + 105°C
High Molecular Weight Polyethylene	- 55°C to + 85°C
Crosslinked Polyolefin	- 30°C to + 85°C
Silicone Rubber	-70° to + 200°C
Silicone Impregnated Fiberglass	- 70°C to + 250°C
High Temperature Nylon Fiber	- 100°C to + 250°C

## N. FLEXIBILITY

Coaxial cables with stranded center conductor and braided outer conductors are intended for use in those applications where the cable must flex repeatedly while in service. Cables with stranded center conductors will exhibit higher attenuation compared to cables with solid center conductors. In general, the higher the number of strands, the better the flexibility and the greater the increase in attenuation.

Standard braided outer conductor constructions will withstand over 1000 flexes through 180° if bent over a radius 20 times the diameter of the cable. Flexible cables may be stored, and are normally shipped, on reels with a hub radius greater than 10 times the diameter of the cable. If a flexible cable is to be installed in a fixed, bent configuration, the minimum

bend radius recommended is 5 times the cable diameter. Tighter bends can be made. Special braid designs are available for improved flex-life.

Coaxial cables with a tubular aluminum or copper outer conductors, commonly referred to as semi-flexible or semi-rigid cables, will not withstand more than ten 180- bends over a bend radius equal to 20 times the diameter of the cable. Semi-flex cables are normally shipped on reels having a hub radius of 20 times the O.D. of the cable. Semi-flex cables may be field bent for installation. The minimum recommended bend radius is equal to 10 times the O.D. of the cable. Cables bent on a bend radius of 5 times the O.D. of the cable may exhibit mechanical and electrical degradation.

## A guide to the selection of RF coaxial cable

### O. ENVIRONMENTAL RESISTANCE

The life of a coaxial cable depends on many factors. The effects of ultra-violet exposure, high humidity, galvanic action, salt-water and corrosive vapors on the materials used are prime causes of cable failure. Resistance to flame must also be considered. The following guidelines apply:

**a. Sunlight:** For low temperature cables exposed to sunlight (ultra-violet), the use of high molecular weight polyethylene, with a specific carbon black particle size, % by weight and particle distribution, is recommended for maximum life expectancy. Polyvinylchloride jackets exhibit a life expectancy of less than 1/2 that of properly compounded polyethylene.

**b. Humidity or water vapor** can enter flexible cables through pin-holes in the jacket, at the connector, or by vapor transmission through the jacket. All materials exhibit a finite vapor transmission rate. For example, a ten foot length of cable with a polymer outer jacket exhibits a helium leak rate of approximately  $10^{-4}$  cc/sec/ft. Even the least porous thermoplastics, such as FEP, do not offer a significant improvement. In airborne applications, the combination of finite vapor transmission rates and large temperature extremes cause condensation in cables. The moisture can collect in low areas causing corrosion or shorting of a connector. One method of preventing moisture accumulation in cables is to fill all voids with a moisture-proofing compound which will not harden with age. See LMR-DB and Imperveon Cables for additional data. Times also supplies hermetically sealed cable assemblies with leak rates of less than  $10^{-5}$  cc/sec/ft.

**c. Salt-water Immersion-**The electrical characteristics of cable will be rapidly affected if the conductors are exposed to salt-water. Unless an immersion test is performed on the jacket, there is a good possibility of one pinhole per 1000 feet. Even if sufficient tests could be performed, damage during installation or damage from rodents normally will cause leakage. Pressure-tight, non-hosing cables capable of withstanding the pressure at the required cable depth can be recommended.

**d. Corrosive Vapors:** The use of tin and silver

coatings does afford some protection against corrosive vapors. However, such protection is short-lived. For installation near salt-water or chemical plants, a filled cable such as LMR-DB or Imperveon is recommended.

**e. Underground Burial & Galvanic Action:** Underground moisture which comes in contact with any cable metals, will cause rapid corrosion. Tubular aluminum outer conductors have been almost destroyed in 90 days. Therefore, any cables installed underground should have pinhole-free jackets. Since jacket damage due to installation techniques and rodents can occur, cables filled with a flooding compound should be used. For maximum reliability against rodents, a steel tape armor with over-jacketing is recommended.

**f. Flame Resistance:** Cables have different degrees of flame resistance depending on the jacket and dielectric material. "Flame retardant" cables are cables having limited flame spread (propagation). PVC jackets offer some flame retardance, depending on the compound selected.

Flame retardant jackets, which are actually within the flame, will burn. If the flame is removed, they will self-extinguish. PVC jackets will not drip burning material. However, if the dielectric is polyethylene, the dielectric may drip ignited materials. PTFE and FEP will not support combustion, drip or burn. TMS has a series of Low Smoke / Low Toxicity cables to provide the utmost in protection. These cables utilize a proprietary TMS compound which is non-halogenated and produces combustion products that are low smoke and low toxicity. See the LSSB/LLSB, LMR-FR and M17 qualified cable lines.

### P. CABLE STRENGTH

The break strength of the cable depends primarily on the strength of the outer conductor. The cables will normally achieve at least 70% of the break strength of the outer conductor, if the center conductor will stretch up to 10% before breakage. Caution must be taken with cables with copper-covered steel or alloy center conductors where breakage would occur with only 1% to 10% elongation. Conductor sizes less than 26 AWG can easily be broken during assembly operations.

Special alloy conductors are available which can achieve a tensile strength of 110,000 psi and 10% elongation.

## Q. QUALIFICATION APPROVAL

Often, cables must be qualified to certain standards to allow usage in particular applications. Typical examples of necessary qualifications are:

**Military:** Most military applications require that cable conform to particular specifications. Many of these specifications require the manufacturer to qualify product by conducting a series of tests on a length of cable with a military representative present as a witness. MIL-C-17, the basic specification for most coaxial cables, requires a Qualified Products List (QPL). TMS maintains numerous MIL-C-17 qualifications.

**Commercial (UL) Approval:** The building codes of many cities require that cables installed in their buildings be approved by the Underwriters Laboratories (UL). With UL service, the cable is subjected to a clearly defined series of tests and examinations, and has met the quality and safety standards imposed by Underwriters Laboratories.

Approval of new designs meeting UL standards normally can be made in a relatively short period of time. A large variety of TMS products are UL approved.

**New York State Requirements:** Article 15, Part 1120 of the New York State Uniform Fire Prevention and Building Code requires that materials used in some buildings and transit systems be tested and registered with The New York Department of State. For the TMS products tested, the fire/gas/toxicity data is found in: DOS file number 16120-931203-4001.

**London Underground Limited:** TMS has gained LUL approval on a series of low-smoke cable constructions. These cables were tested for smoke emission, toxic fume emission, and flammability assessment against the requirements of the London Underground Code of Practice for fire safety.

Contact your TMS representative for more information regarding TMS product qualifications.

**MSHA Approvals:** TMS has qualified the complete range of LMR-FR coaxial cables (file number 07-KA070010-MSHA-P) and T-RAD-FR leaky feeder cables (file number 07-KA07009-MSHA-P) to the MSHA flame requirements. Contact your TMS representative for further information.



**Attenuation ( dB per 100 feet ; +25C )**

	2 1/4" LDF	1 5/8" LDF	1 1/4" LDF	LMR-1700	7/8" LDF	LMR-1200	LMR-900	1/2" LDF	LMR-600	LMR-500	1/2" SuperFlex	3/8" LDF
Frequency / Size	2.350*	1.980*	1.550*	1.670*	1.090*	1.200*	0.870*	0.630*	0.590*	0.500*	0.520*	0.440*
30 MHz	0.096*	0.120	0.147	0.149	0.197	0.209	0.288	0.369	0.421	0.54	0.561	0.567
50 MHz	0.125*	0.156	0.191	0.195	0.257	0.272	0.374	0.479	0.547	0.70	0.730	0.736
150 MHz	0.227*	0.280	0.340	0.347	0.458	0.481	0.658	0.845	0.964	1.22	1.29	1.30
220 MHz	0.281*	0.345*	0.416*	0.427	0.560*	0.589	0.803	1.05*	1.18	1.49	1.58*	1.59*
450 MHz	0.422	0.515	0.617	0.632	0.834	0.864	1.17	1.51	1.72	2.17	2.32	2.30
700 MHz	--	--	--	0.809	--	1.10	1.48	--	2.18	2.77	--	--
900 MHz	0.641*	0.767*	0.912*	0.936	1.23*	1.27	1.70	2.21*	2.50	3.13	3.41*	3.36*
1,500 MHz	0.879*	1.050	1.22	1.26	1.66	1.69	2.24	2.93	3.31	4.13	4.57	4.43
2,000 MHz	1.058*	1.250	1.45	1.50	1.97	1.99	2.63	3.45	3.90	4.84	5.41	5.21
2,500 MHz	--	1.440	1.68*	1.71	2.27*	2.26	2.98	3.91*	4.42	5.48	6.17*	5.91*

Attenuation at Any Frequency = [ k1 x SqRt (Fmhz) ] + [ k2 x Fmhz ] or use Performance Calculator at [www.timesmicrowave.com](http://www.timesmicrowave.com)

k1				0.02646		0.03737	0.05177		0.07555	0.09659		
k2				0.00016		0.00016	0.00016		0.00026	0.00026		

**Power Handling ( kW ; +40C ; Sea Level )**

	2 1/4" LDF	1 5/8" LDF	1 1/4" LDF	LMR-1700	7/8" LDF	LMR-1200	LMR-900	1/2" LDF	LMR-600	LMR-500	1/2" SuperFlex	3/8" LDF
Frequency / Size	2.350*	1.980*	1.550*	1.670*	1.090*	1.200*	0.870*	0.630*	0.590*	0.500*	0.520*	0.440*
30 MHz	39.5*	28.9	21.1	20.3	14.0	12.6	8.9	6.31	5.5	4.4	5.75	4.14
50 MHz	30.2*	22.1	16.2	15.6	10.7	9.7	6.8	4.85	4.3	3.4	4.42	3.19
150 MHz	16.7*	12.3	9.09	8.7	6.04	5.5	3.9	2.75	2.4	1.9	2.49	1.81
220 MHz	13.5*	13.5*	7.45*	7.1	4.94*	4.5	3.2	2.23*	1.9	1.6	2.04*	1.49*
450 MHz	8.91	6.71	5.01	4.8	3.32	3.1	2.2	1.53	1.3	1.1	1.38	1.02
700 MHz	--	--	--	3.8	--	2.4	1.7	--	1.1	0.85	--	--
900 MHz	5.90*	4.49*	3.39*	3.3	2.24	2.1	1.5	1.05*	0.93	0.75	0.944*	0.703*
1,500 MHz	4.29*	3.30	2.52	2.4	1.66	1.6	1.1	0.793	0.70	0.57	0.705	0.530
2,000 MHz	3.57*	2.76	2.13	2.0	1.40	1.3	1.0	0.673	0.59	0.49	0.597	0.451
2,500 MHz	--	2.40	1.84*	1.8	1.21*	1.2	0.9	0.594*	0.52	0.43	0.547*	0.398*

**General Performance Properties**

	LMR-1700	LMR-1200	LMR-900	LMR-600	LMR-500	LMR-400	LMR-300	LMR-240	LMR-200
Conductor: (note 1)	0.527*	0.349*	0.262*	0.176*	0.142*	0.108*	0.070*	0.056*	0.044
Dielectric: Cellular PE (note 2)	1.350*	0.920*	0.680*	0.455*	0.370*	0.285*	0.190*	0.150*	0.116
Shield: Aluminum Tape (note 3)	1.356*	0.926*	0.686*	0.461*	0.376*	0.291*	0.196*	0.155*	0.121
Tinned Copper Braid	1.402*	0.972*	0.732*	0.490*	0.405*	0.320*	0.225*	0.178*	0.144
Jacket: Black PE (note 4)	1.670*	1.200*	0.870*	0.590*	0.500*	0.405*	0.300*	0.240*	0.195
Bend Radius (note 5)	13.5*	6.5*	3*	1.5*	1.25*	1*	.875*	0.75*	0.50*
Weight(lbs/foot)	0.736	0.448	0.266	0.131	0.097	0.068	0.055	0.034	0.022
Temperature Range	-40°C to +85°C								
Impedance	50 Ohms								
Velocity (%)	89	88	87	87	86	85	85	84	83
Capacitance (pF per Foot)	22.8	23.1	23.4	23.4	23.6	23.9	23.9	24.2	24.5
DC Resistance: center conductor	0.21	0.32	0.54	0.53	0.82	1.39	2.12	3.20	5.36
(ohms/1000') ; shield	0.27	0.37	0.55	1.20	1.27	1.65	2.21	3.89	4.90
Shielding	> 90 db								
Phase Stability	+/- 10 ppm/degC								

ex	3/8" LDF	LMR-400	3/8" SuperFlex	Belden 9913	ULTRA-LINK™	RG213/ RG214	1/4" SuperFlex	LMR-300	LMR-240	Belden RG8X	LMR-200	ULTRA-LINK	LMR-195	RG-58	LMR-100A
	0.440*	0.405*	0.415*	0.405*	0.405*	0.405*	0.300*	0.300*	0.240*	0.242*	0.195*	0.195*	0.195*	0.195*	0.110*
	0.567	0.7	0.654	0.8	0.7	1.2	0.98	1.1	1.3	2.0	1.8	2.5	2.0	2.5	3.9
	0.736	0.9	0.848	0.9	--	1.6	1.27	1.4	1.7	2.5	2.3	--	2.6	3.1	5.1
	1.30	1.5	1.49	1.6	1.5	2.8	2.23	2.4	3.0	4.7	4.0	5.1	4.4	6.2	8.9
	1.59*	1.8	1.82*	--	--	3.5	2.72	2.9	3.7	6.0	4.8	--	5.4	7.4	10.9
	2.30	2.7	2.66	2.8	2.7	5.2	3.93	4.2	5.3	8.6	7.0	9.5	7.8	10.6	15.8
	--	3.42	--	--	--	--	--	5.1	6.6	--	8.7	--	9.8	--	20.0
	3.36*	3.9	3.86*	4.2	4.19	8.0	5.67*	6.1	7.6	12.8	9.9	14.0	11.1	16.5	22.8
	4.43	5.1	5.12	5.6	--	--	7.47	7.9	9.9	--	12.9	--	14.5	--	30.0
	5.21	6.0	6.01	6.7	--	--	8.73	9.2	11.5	--	15.0	--	16.9	--	35.0
	5.91*	6.8	6.84*	--	6.8*	--	9.85*	10.4	12.9	--	16.9	37*	19.0	--	40.0
		0.12229						0.19193	0.24208		0.32090		0.35686		0.70914
		0.00026						0.00033	0.00033		0.00033		0.00047		0.00174

ex	3/8" LDF	LMR-400	3/8" SuperFlex	Belden 9913	ULTRA-LINK	RG213/ RG214	1/4" SuperFlex	LMR-300	LMR-240	Belden RG8X	LMR-200	ULTRA-LINK	LMR-195	RG-58	LMR-100A
	0.440*	0.405*	0.415*	0.405*	0.405*	0.405*	0.300*	0.300*	0.240*	0.242*	0.195*	0.195*	0.195*	0.195*	0.110*
	4.14	3.3	3.97	2.2	--	1.8	2.28	2.1	1.49	0.35	1.02	4.0	0.89	0.40	0.23
	3.19	2.6	3.06	1.7	--	1.2	1.76	1.6	1.15	0.28	0.79	--	0.68	0.30	0.18
	1.81	1.5	1.74	0.90	--	0.62	1.00	0.93	0.66	0.15	0.45	2.0	0.39	0.16	0.10
	1.49*	1.2	1.44*	--	--	--	0.825*	0.76	0.54	--	0.37	--	0.32	--	0.08
	1.02	0.83	0.975	0.45	--	0.30	0.567	0.52	0.38	0.08	0.26	1.0	0.22	0.08	0.06
	--	0.66	--	--	--	--	--	0.43	0.30	--	0.21	--	0.18	--	0.05
	0.703*	0.58	0.674*	0.28	--	0.18	0.393*	0.36	0.26	0.05	0.18	0.65	0.15	0.05	0.040
	0.530	0.44	0.507	0.20	--	--	0.299	0.28	0.20	--	0.14	--	0.12	--	0.030
	0.451	0.37	0.431	0.16	--	--	0.256	0.24	0.17	--	0.12	--	0.10	--	0.025
	0.398*	0.33	0.379*	--	--	--	0.225*	0.21	0.15	--	0.11	--	0.09	--	0.020

Trademarks are the exclusive property of their respective owners.  
 Competitor's Data As Published  
 \*estimated from published data.

### NOTES:

- Center Conductor in LMR-900, LMR-1200 & LMR-1700 is Copper Tube  
Center Conductor in LMR-400, LMR-500 & LMR-600 is Copper Clad Aluminum  
Center Conductor in LMR-195, LMR-200, LMR-240 and LMR-300 is Bare Copper  
LMR-100A is BCCS
- Low loss closed cell polyethylene foam (LMR-100A solid polyethylene)
- Aluminum laminated tape bonded (LMR-100A unbonded) to the Dielectric with a Tinned Copper Overbraid
- Black UV protected polyethylene (LMR-100A black PVC)
- Less than 1 ohm impedance change at bend

LMR-200	LMR-195	LMR-100A
0.044*	0.037*	0.018*
0.116*	0.110*	0.060*
0.121*	0.116*	0.065*
0.144*	0.139*	0.083*
0.195*	0.195*	0.110*
0.50*	0.50*	0.25*
0.022	0.021	0.009
83	80	66
24.5	25.4	30.8
5.36	7.58	81.0
4.90	4.90	9.5

## X-ON Electronics

Largest Supplier of Electrical and Electronic Components

*Click to view similar products for [Spiral Wraps, Sleeves, Tubing & Conduit](#) category:*

*Click to view products by [Amphenol](#) manufacturer:*

Other Similar products are found below :

[CTA-0053](#) [8423-6](#) [8426-11](#) [8429-9](#) [25](#) [202C302-13-0](#) [RAY-103-10.0\(100\)](#) [RAY-103-4.0\(100\)](#) [4627-S](#) [5026790001](#) [100-003A1000](#) [102-060-008](#) [103-013-012](#) [5356510001](#) [8445-2.5](#) [24028-1](#) [100-001A203](#) [121-103-1-1-09BFTTH](#) [420AJ001Z11402](#) [T25R-M](#) [SAS-090-1-1048-1X](#) [SAS-160-1-1030-0](#) [RAY-101-3.0\(100\)](#) [8428-18](#) [8429-12](#) [8659](#) [8328](#) [100-003A750](#) [100-003A109](#) [102-072-008](#) [HC1B-7008-0312-0](#) [2030758-3](#) [22A00010-0DH16](#) [100-003A078](#) [OSPU 10](#) [CS-A900T](#) [THP6B](#) [330.012.2](#) [330.012.3](#) [330.016.2](#) [330.020.3](#) [373.016.2](#) [CYLG-29B](#) [61747000](#) [61806130](#) [61806140](#) [166-30730](#) [162-20100](#) [348.016.1](#) [3110000817](#)