

REV.	ECN NO.	DATE	SIGN	DESCRIPTION

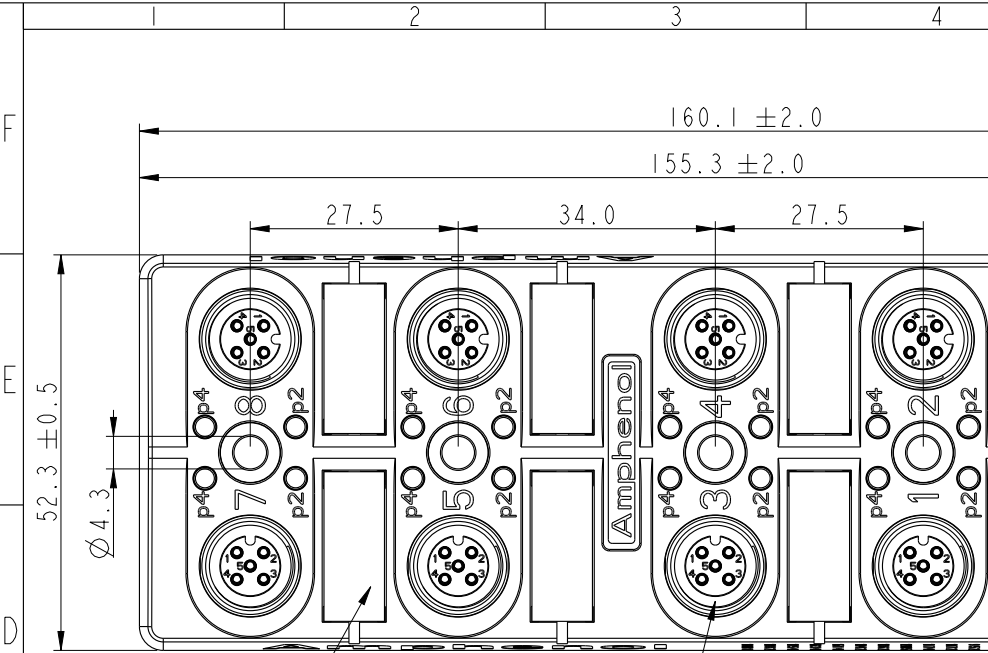

- 5 O-ring
- 6 O-ring

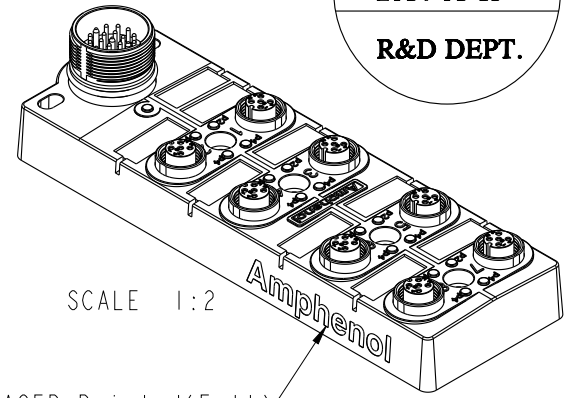
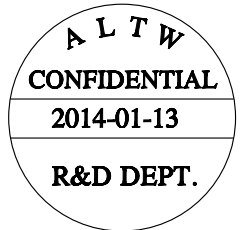

SCALE 1:2

- Label 10
- O-ring 7
- LED Cover 2
- O-ring 3
- 1 8Port Box
- 4 PCBA
- 8 Screw
- 9 Glue

LASER Printed(Full)

Note:

Electrical:

- \* Voltage: 10~30V DCMax.
- \* Current per Port: 4A
- \* Current Sum Max.: 12A
- \* Power indicator: 1\*LED, Green
- \* Function Indicator: 16 \* LED Yellow
- \* Sensor Connections: M12\*1, 5-pole Female
- \* Switching Output: PNP

Mechanical:

- \* Homerun Connector: M23
- \* Connector Housing Material: PA66,Nylon+GF
- \* Box Material: PBT+PC
- \* Contact Material: Copper Alloy
- \* Contact Finish: Gold plated
- \* No. of Ports: 8
- \* Style: M12\*1
- \* Mounting type: 4 \* M4

Environmental:

- \* Operating Temperature : -25°C~+90°C
- \* Waterproof Rate: IP67 (Unmated)
- \* Oil Resistant

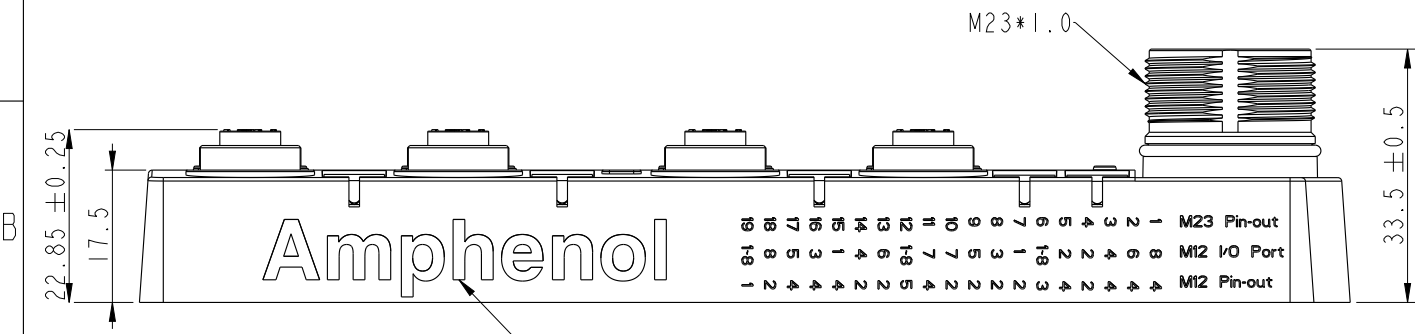

LASER Printed(Full)

19	18	17	16	15	14	13	12	11	10	9	8	7	6	5	4	3	2	1	M23 Pin-out
19	18	17	16	15	14	13	12	11	10	9	8	7	6	5	4	3	2	1	M12 I/O Port
19	18	17	16	15	14	13	12	11	10	9	8	7	6	5	4	3	2	1	M12 Pin-out

UNIT: mm

TOLERANCE	
.X	±0.25
.XX	±0.1
.XXX	±0.05
ANGLES	±1°

TITLE M12 Distribution Box 8Port, M23			
SCALE	SIZE	SHEET	OF
1:1	A4	1	2
REV.	WC-REV.	QC: Inspection item	
A	A.3		

**Amphenol LTW**  
安費諾亮泰企業股份有限公司

ITEM NO. DB12-5A8M23-DPS7001	DRAWN BY Tony_leng	DATE 2014/01/13
DWG NO. DB12-5A8M23-DPS7001	CHECKED BY Jimmy	DATE 2014/01/13
CUSTOMER ALTW	APPROVED BY Jerry	DATE 2014/01/13

THIS DOCUMENT IS SUBJECT TO CHANGE WITHOUT NOTICE. IT IS CONFIDENTIAL AND A PROPERTY OF Amphenol LTW. DISCLOSURE TO THIRD PARTY HAS TO BE AUTHORIZED BY Amphenol LTW.

# Schematic Diagram

## M23 Homerun Connector

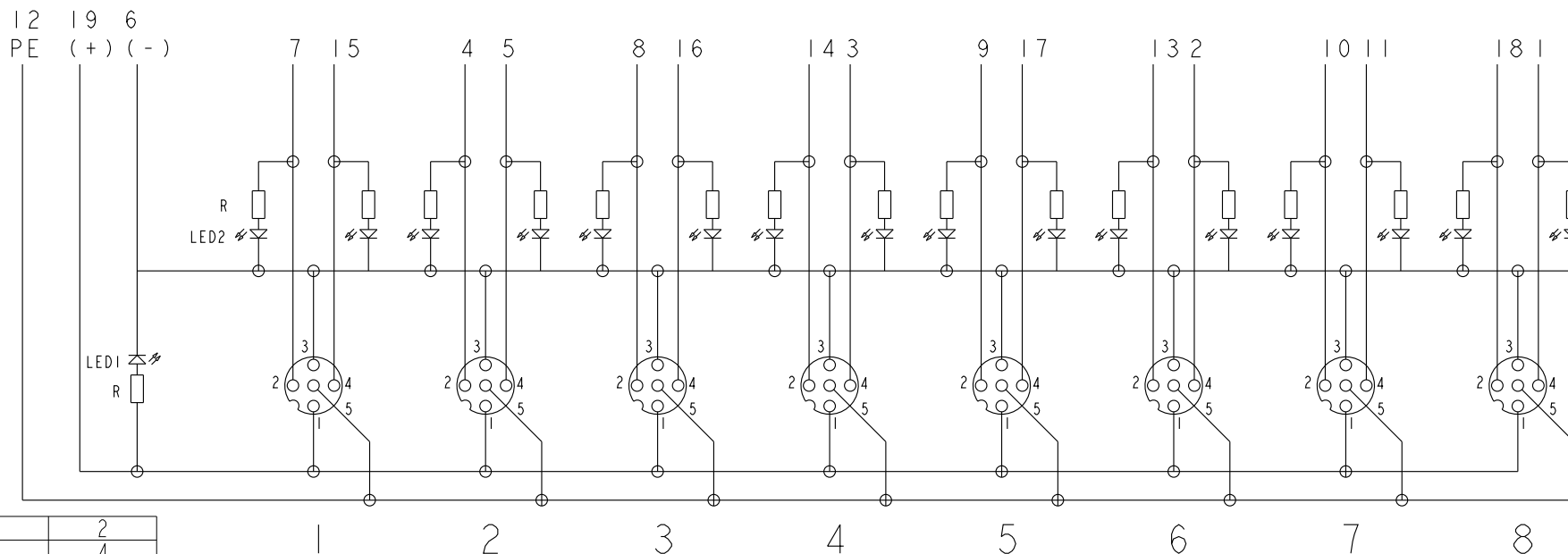

18	8	2
17	5	4
16	3	4
15	1	4
14	4	2
13	6	2
11	7	4
10	7	2
9	5	2
8	3	2
7	1	2
5	2	4
4	2	2
3	4	4
2	6	4
1	8	4
19(+V)	1-8	1
6(-V)	1-8	3
12(PE)	1-8	5
M23 Pin	Port	M12 Pin

## M12 I/O Ports

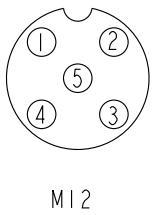
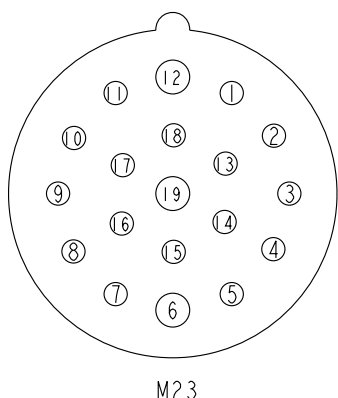

I/O Ports  
 Pin1: +V  
 Pin2: NC  
 Pin3: -V  
 Pin4: NO  
 Pin5: PE

Parts  
 LED1: Green  
 LED2: Yellow  
 R: Resistor

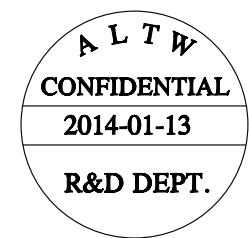

UNIT: mm		
TOLERANCE		
.X	±0.25	
.XX	±0.1	
.XXX	±0.05	
ANGLES	±1°	

TITLE M12 Distribution Box 8Port, M23			
SCALE 1:2	SIZE A4	SHEET 2 OF 2	
REV. A	WC-REV. A.3	QC: Inspection item	

**Amphenol LTW**  
 安費諾亮泰企業股份有限公司

ITEM NO DB12-5A8M23-DPS7001	DRAWN BY Tony_leng	DATE 2014/01/13
DWG NO DB12-5A8M23-DPS7001	CHECKED BY Jimmy	DATE 2014/01/13
CUSTOMER ALTW	APPROVED BY Jerry	DATE 2014/01/13

THIS DOCUMENT IS SUBJECT TO CHANGE WITHOUT NOTICE. IT IS CONFIDENTIAL AND A PROPERTY OF Amphenol LTW. DISCLOSURE TO THIRD PARTY HAS TO BE AUTHORIZED BY Amphenol LTW.

## X-ON Electronics

Largest Supplier of Electrical and Electronic Components

*Click to view similar products for [Circular Metric Connectors](#) category:*

*Click to view products by [Amphenol](#) manufacturer:*

Other Similar products are found below :

[600X518037X](#) [6STD15PCR99B70A](#) [8R4000A16M020](#) [8R5000A16M005](#) [1200910002](#) [1203580030](#) [1200910008](#) [1200910011](#) [1300140094](#)  
[130203-0054](#) [1300140026](#) [1300150099](#) [1-3637-600-5205](#) [1612618](#) [21036836414](#) [8R4006A16M010](#) [1R3006A20M005](#) [41-40011](#) [42-00006](#)  
[42-01015](#) [4-22279-4](#) [4-22281-1](#) [4-22284-9](#) [43-00113](#) [43-01088](#) [43-01203](#) [41-40013](#) [42-00008](#) [43-00343](#) [43-01026](#) [43-01162](#) [43-01173](#) [43-](#)  
[10000](#) [XS3P-M421-2](#) [600X518050X](#) [8R5006A16M020](#) [8R4000A16M010](#) [6-22279-3](#) [1605332](#) [N03FA03144](#) [1300140077](#) [43-16213](#) [43-](#)  
[01338](#) [XS2RD4265](#) [XS2R-D426-1](#) [XS8A-0441](#) [859RD04-103R004](#) [860RD04-113R004](#) [860RD04-213R004](#) [1-213245-2](#)