

REV.	ECN NO.	DATE	SIGN	DESCRIPTION
B	LE3-960040	2009/06/22	Prune	Change The Note And 螺牙

ALTW  
DCC. DEPT.  
CONFIDENTIAL  
2012-06-13  
ISSUED

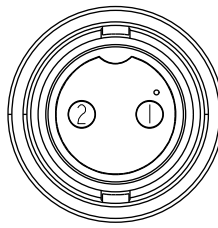
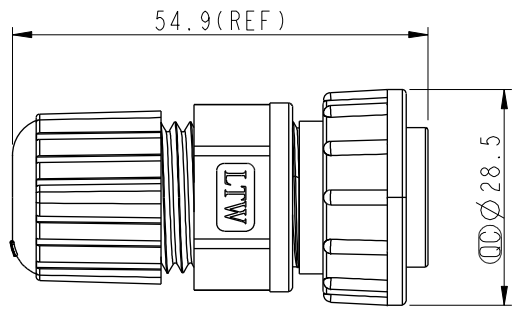
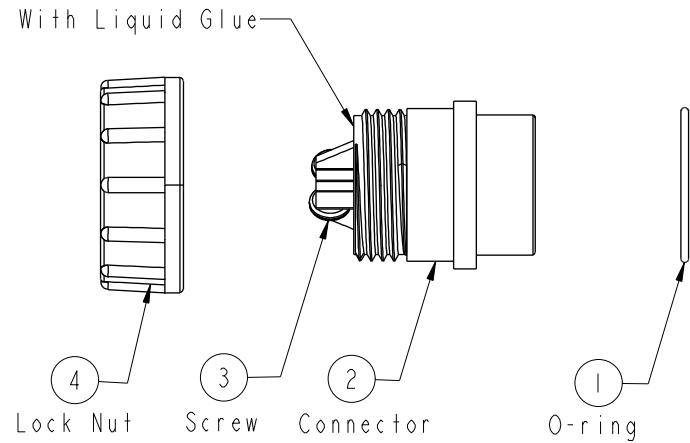
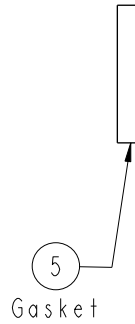
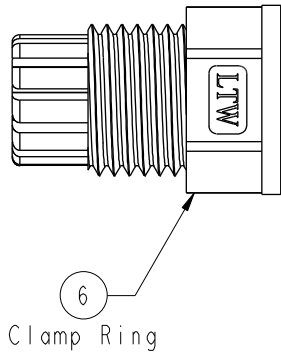
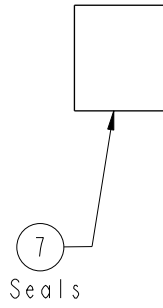
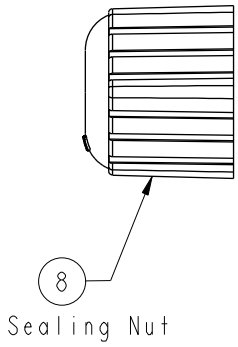

Pin Assignments  
Front View

ALTW  
CONFIDENTIAL  
2012-05-03  
R&D DEPT.

- Note:
- \*  $\varnothing$  Important Dimension To Check.
  - \* Waterproof Rate: IP67
  - \* Housing: Nylon+GF
  - \* Pin: Copper Alloy, Gold Plated
  - \* Liquid Glue: Clear
  - \* Screw: Stainless Steel
  - \* Ring: Black, EPDM
  - \* Nut: Black, Nylon+GF
  - \* Gasket: Black, Silicone
  - \* Clamping Ring: Black, Nylon
  - \* Seals: Black, EPDM
  - \* Sealing Nut: Black, Nylon
  - \* PE Bag  $\text{\textcircled{9}}$  \* PE Bag: 90\*85mm
  - \* Seal For Cable OD:  $\varnothing$  5.5mm~10.8mm
  - \* One Set Unassembled In One PE Bag
  - $\triangle$  \* Application AWG: 14~16AWG

UNIT: mm		
TOLERANCE	.X $\pm 0.25$	
	.XX $\pm 0.1$	
	.XXX $\pm 0.05$	
ANGLES	$\pm 1^\circ$	

TITLE Large Assy Lock 2Pin F Conn M Pin			
SCALE 1:1	SIZE A4	SHEET 1 OF 1	
REV. B	WC-REV. A.2	$\varnothing$ : Inspection item	

**Amphenol LTW**  
安費諾亮泰企業股份有限公司

ITEM NO. DC-02BFMB-LL7001	DRAWN BY SamChang	DATE 2012-05-03
DWG NO. DC-02BFMB-LL7001	CHECKED BY Jeffrey	DATE 2012-06-13
CUSTOMER ALTW	APPROVED BY Lion	DATE 2012-06-13

THIS DOCUMENT IS SUBJECT TO CHANGE WITHOUT NOTICE. IT IS CONFIDENTIAL AND A PROPERTY OF AMPHENOL LTW. DISCLOSURE TO THIRD PARTY HAS TO BE AUTHORIZED BY AMPHENOL LTW.

## X-ON Electronics

Largest Supplier of Electrical and Electronic Components

*Click to view similar products for [Standard Circular Connector](#) category:*

*Click to view products by [Amphenol](#) manufacturer:*

Other Similar products are found below :

[5M2530B10P](#) [600259N006](#) [600273N007](#) [6134-336-13149](#) [6134-337-11149](#) [6134-337-2390](#) [6134-341-17149](#) [6280-4SG-516](#) [6280-7SG-3DC](#)  
[6290](#) [6291A](#) [66200A-10](#) [680-SMG](#) [681-PMG](#) [CXS3102A14S2P](#) [CXS3102A181S](#) [7251-6SG-300](#) [7271-6SG-300](#) [7282-3PG-300-CH3](#) [75-](#)  
[474014-05S](#) [75-474618-01S](#) [75-474618-04P](#) [75-474618-04S](#) [799539-000](#) [MI8-SE](#) [805-005-07NF11-19PC](#) [805-005-07NF15-7PA](#) [8280-4PG-](#)  
[516](#) [8280-7PG-519](#) [8282-5PG-519](#) [836783-1](#) [MP-4102-25P-C](#) [862256-1](#) [864019-2](#) [866857-1](#) [867865-1](#) [PT01SP-14-18P](#) [PT08P-14-5S](#)  
[PTSF06SE-14-12S](#) [120-1833-000](#) [QCM019PC2DC012B](#) [1-2069279-1](#) [121583-0217](#) [121667-0020](#) [129591AU](#) [1000B BULK](#) [RD10A16-19-](#)  
[P6CS051/1](#) [RD10A20-31-P8CS051/1](#) [RD16A14-12-S6CS051/2](#) [1301240290](#) [1301240347](#)