

REV.	ECN NO.	DATE	SIGN	DESCRIPTION
B	LE3-960042	2009/06/22	Prune	Change The Note And 螺牙

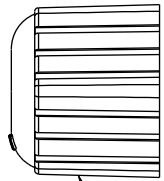

8
Sealing Nut



7
Seals

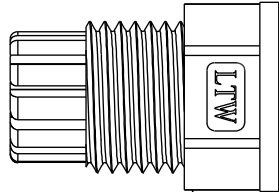

6
Clamp Ring

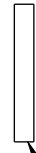

5
Gasket

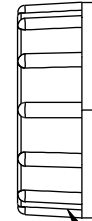

4
Lock Nut

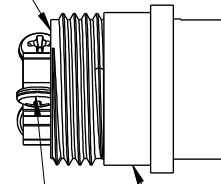

3
Screw



2
Connector



1
O-ring

With Liquid Glue

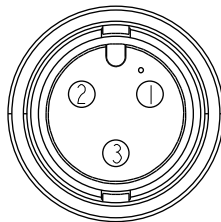
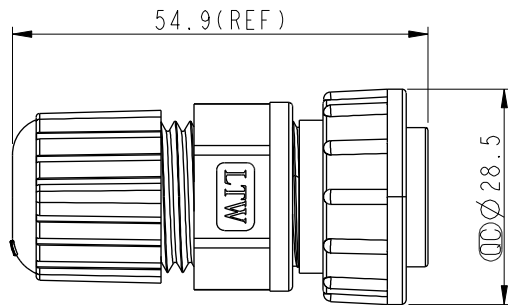

Pin Assignments
Front View

ALTW
CONFIDENTIAL
2012-05-04
R&D DEPT.

ALTW
DCC. DEPT.
CONFIDENTIAL
2012-06-27
ISSUED

Note:

- * (∅) Important Dimension To Check.
- * Waterproof Rate: IP67
- * Housing: Black, Nylon+GF
- * Pin: Copper Alloy, Gold Plated
- * Liquid Glue: Clear
- * Screw: Stainless Steel
- * Ring: Black, EPDM
- * Nut: Black, Nylon+GF
- * Gasket: Black, Silicone
- * Clamping Ring: Black, Nylon
- * Seals: Black, EPDM
- * Sealing Nut: Black, Nylon
- * PE Bag: 90*85mm
- * Seal For Cable OD: $\varnothing 5.5\text{mm} \sim 10.8\text{mm}$
- * One Set Unassembled In One PE Bag
- * Application AWG: 14~16AWG

PE Pag 9

UNIT: mm		
TOLERANCE	.X ± 0.25	
	.XX ± 0.1	
	.XXX ± 0.05	
ANGLES	$\pm 1^\circ$	

TITLE Large Assy Lock 3Pin F Conn F Pin			
SCALE 1:1	SIZE A4	SHEET 1 OF 1	
REV. B	WC-REV. A.2	∅: Inspection item	

Amphenol LTW
安費諾亮泰企業股份有限公司

ITEM NO. DC-03BFFB-LL7001	DRAWN BY SamChang	DATE 2012-05-04
DWG NO. DC-03BFFB-LL7001	CHECKED BY Jeffrey	DATE 2012-06-27
CUSTOMER ALTW	APPROVED BY Lion	DATE 2012-06-27

THIS DOCUMENT IS SUBJECT TO CHANGE WITHOUT NOTICE. IT IS CONFIDENTIAL AND A PROPERTY OF AMPHENOL LTW. DISCLOSURE TO THIRD PARTY HAS TO BE AUTHORIZED BY AMPHENOL LTW.

X-ON Electronics

Largest Supplier of Electrical and Electronic Components

Click to view similar products for [Standard Circular Connector](#) category:

Click to view products by [Amphenol](#) manufacturer:

Other Similar products are found below :

[5M2530B10P](#) [600259N006](#) [600273N007](#) [6134-336-13149](#) [6134-337-11149](#) [6134-337-2390](#) [6134-341-17149](#) [6280-4SG-516](#) [6280-7SG-3DC](#)
[6290](#) [6291A](#) [66200A-10](#) [680-SMG](#) [681-PMG](#) [CXS3102A14S2P](#) [CXS3102A181S](#) [7251-6SG-300](#) [7271-6SG-300](#) [7282-3PG-300-CH3](#) [75-](#)
[474014-05S](#) [75-474618-01S](#) [75-474618-04P](#) [75-474618-04S](#) [799539-000](#) [MI8-SE](#) [805-005-07NF11-19PC](#) [805-005-07NF15-7PA](#) [8280-4PG-](#)
[516](#) [8280-7PG-519](#) [8282-5PG-519](#) [836783-1](#) [MP-4102-25P-C](#) [862256-1](#) [864019-2](#) [866857-1](#) [867865-1](#) [PT01SP-14-18P](#) [PT08P-14-5S](#)
[PTSF06SE-14-12S](#) [120-1833-000](#) [QCM019PC2DC012B](#) [1-2069279-1](#) [121583-0217](#) [121667-0020](#) [129591AU](#) [1000B BULK](#) [RD10A16-19-](#)
[P6CS051/1](#) [RD10A20-31-P8CS051/1](#) [RD16A14-12-S6CS051/2](#) [1301240290](#) [1301240347](#)