

THIS DOCUMENT IS SUBJECT TO CHANGE WITHOUT NOTICE. IT IS CONFIDENTIAL AND A PROPERTY OF AMPHENOL LTW. DISCLOSURE TO THIRD PARTY HAS TO BE AUTHORIZED BY AMPHENOL LTW.

REV.	ECN NO.	DATE	SIGN	DESCRIPTION
D	C191385	2019/08/02	Siou	Revise Rated Voltage.
E	E191814	2019/10/23	Ruru	△E x 3
F	C210786	2021/06/06	Angel Chou	△E x 5

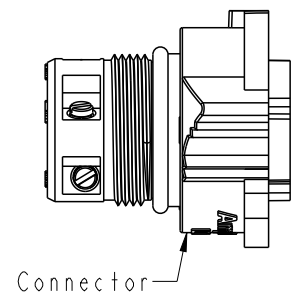
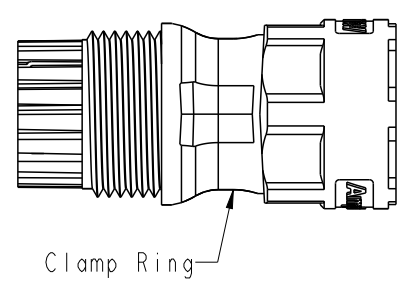
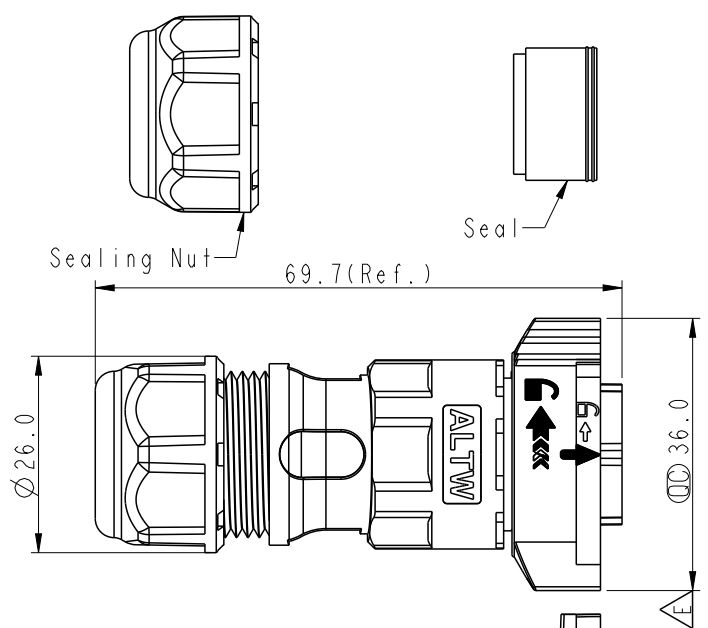

- DC-XXBFFB-QL8XPP
- △ 02-2 Pin
 - △ 03-3 Pin
 - △ 04-4 Pin
 - △ 05-5 Pin

- S: With Red Color Seal 1, Cable OD 8.0~10.0mm.
- M: With Yellow Color Seal 2, Cable OD 10.0~12.0mm.
- L: With Blue Color Seal 3, Cable OD 12.0~14.0mm.
- A: With Seal 1 & Seal 2 & Seal 3.

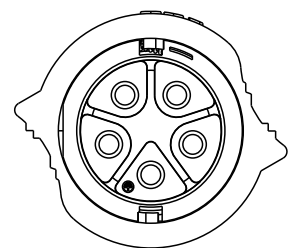
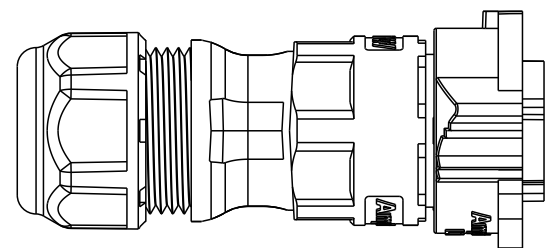

△E △F Note:

- * RoHS Compliant
- * Ⓞ Important Dimension
- * Waterproof Rate: IPX8, Mated 1m/24h
- * Connector
- Housing: Thermoplastic, Black
- Pin: Copper Alloy, Gold Plated
- Clamp Ring: Thermoplastic, Black
- Sealing Nut: Thermoplastic, Black
- Seals: Rubber

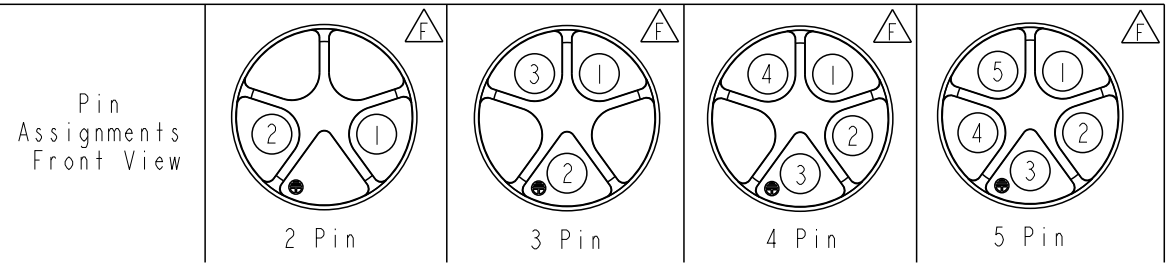

UNIT:mm TOLERANCE ±0.5 mm		TITLE XLOK, D-20A, 02P, CABLE W/O SR F, F, FI SCREW IN, XLOK △E	<h1>Amphenol LTW</h1> <p>安費諾亮泰企業股份有限公司</p>		ITEM NO	DRAWN BY	DATE		
		SCALE 8:5			SIZE A4	SHEET 1 OF 2	DWG NO DC-XXBFFB-QL8XPP	CHECKED BY	DATE
		REV. F			WC-REV. A.3	QC: Inspection item	CUSTOMER ALTW	APPROVED BY	DATE
						Siou	2019-08-02		
						Eagle	2019-08-02		
						Neo	2019-08-02		

THIS DOCUMENT IS SUBJECT TO CHANGE WITHOUT NOTICE. IT IS CONFIDENTIAL AND A PROPERTY OF Amphenol LTW. DISCLOSURE TO THIRD PARTY HAS TO BE AUTHORIZED BY Amphenol LTW.

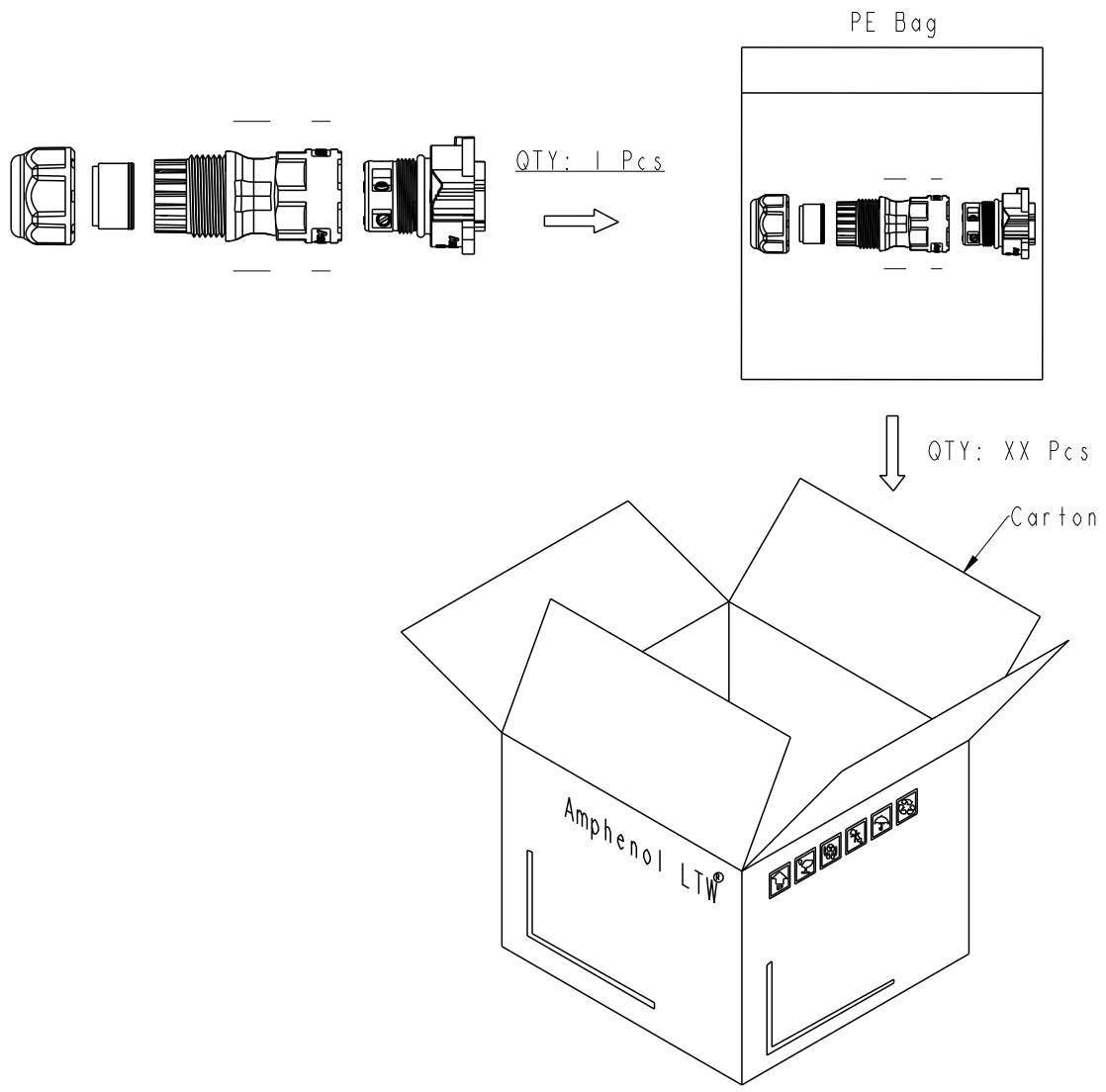

Note:
 * One Set Unassembled In One PE Bag.
 (每一組未組裝, 放置於一個PE袋, 並封口, 如圖示)
 * Label is Attached To PE Bag Front.
 (標籤貼在PE袋正面)

UNIT:mm	
TOLERANCE ±0.5 mm	

TITLE XLOK, D-20A, 02P, CABLE W/O SR F, F, FI SCREW IN, XLOK			
SCALE 8:5	SIZE A4	SHEET 2 OF 2	
REV. F	WC-REV. A.3	☉: Inspection item	

Amphenol LTW
 安費諾亮泰企業股份有限公司

ITEM NO	DRAWN BY Siou	DATE 2019-08-02
DWG NO DC-XXBFFB-QL8XPP	CHECKED BY Eagle	DATE 2019-08-02
CUSTOMER ALTW	APPROVED BY Neo	DATE 2019-08-02

X-ON Electronics

Largest Supplier of Electrical and Electronic Components

Click to view similar products for [Circular Metric Connectors](#) category:

Click to view products by [Amphenol](#) manufacturer:

Other Similar products are found below :

[600X518037X](#) [6STD15PCR99B70A](#) [8R4000A16M020](#) [8R5000A16M005](#) [1200910002](#) [1203580030](#) [1200910008](#) [1200910011](#) [1300140094](#)
[130203-0054](#) [1300140026](#) [1300150099](#) [1-3637-600-5205](#) [1612618](#) [21036836414](#) [8R4006A16M010](#) [1R3006A20M005](#) [41-40011](#) [42-00006](#)
[42-01015](#) [4-22279-4](#) [4-22281-1](#) [4-22284-9](#) [43-00113](#) [43-01203](#) [41-40013](#) [42-00008](#) [43-00343](#) [43-01026](#) [43-01162](#) [43-01173](#) [43-10000](#)
[XS3P-M421-2](#) [600X518050X](#) [8R5006A16M020](#) [8R5006A16M005](#) [8R4000A16M010](#) [6-22279-3](#) [1605332](#) [N03FA03144](#) [1300140077](#) [43-](#)
[16213](#) [43-01338](#) [XS2RD4265](#) [XS2R-D426-1](#) [XS8A-0441](#) [859RD04-103R004](#) [860RD04-113R004](#) [860RD04-213R004](#) [1-213245-2](#)