



DLC - Compact High Resolution Pressure Sensor Series

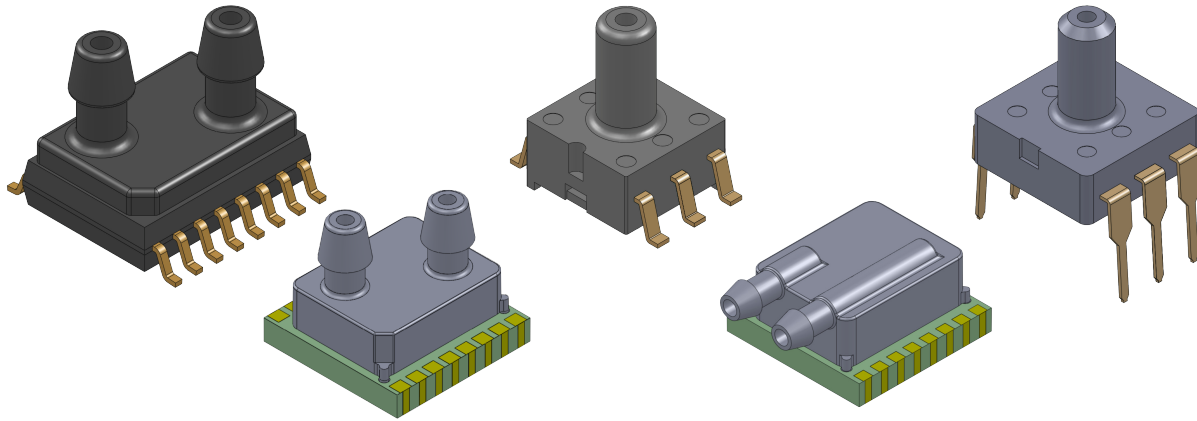

Table of Contents

Features & Applications	2
Pressure Sensor Maximum Ratings	2
Environmental Specifications	2
Example Circuit.....	2
Standard Pressure Ranges.....	3
Performance Characteristics	4
I ² C Electrical Parameters	4
Pressure Output Transfer Function	5
Temperature Output Transfer Function	5
Soldering Recommendations.....	5
Device Ordering Options.....	6
Operation Overview	6-7
Digital Interface Command & Data Formats.....	7-8
I ² C Interface	8-10
How to Order Guide.....	10
Standard Part Number Configurations	11
Product Identification for D4, U1, U2 Packages...	12
Product Identification for LD2, LD4 Packages.....	13
Dimensional Package Drawings	
Differential SMT, SML, and SOIC	14-15
Gage DIP and SMT	16
Packing Options.....	17
Pressure Tubing Recommendations.....	17
Suggested Pad Layouts	17

Introduction

The DLC Series Compact High Resolution Sensor is based on All Sensors' CoBeam²™ Technology. This reduces package stress susceptibility, resulting in improved overall long term stability. This technology breakthrough advances the state of the art for piezoresistive pressure sensors beyond what has been achieved for low pressure sensing using silicon based strain technology. Design engineers will find exceptional space savings with optimal performance for various compact applications. The DLC series product family's low cost makes it the perfect solution for applications that require very low prices with high volume.

The low supply voltage allows for integration of the sensors into a wide range of process control and measurement systems, as well as direct connection to I2C serial communications channels. The DLC series offers 16 bit digital resolution. For battery-powered systems, the sensors can enter very low-power modes between readings to minimize load on the power supply.

These calibrated and compensated sensors provide accurate, stable output over a wide temperature range. This series is intended for use with non-corrosive, non-ionic working fluids such as air and dry gases. A protective parylene coating is optionally available for moisture/harsh media protection.

<https://www.allsensors.com/products/dlc-series>



For All Sensors Corporation's most recent quality certification documents, please visit www.allsensors.com



DLC - COMPACT HIGH-RESOLUTION PRESSURE SENSORS

Features

- Pressure Ranges from 1 inH₂O to 150 PSI
- High Resolution 16 bit Output
- Digital I2C Interface
- 1.8V to 3.6V Supply Voltage Range
- Parylene coating offered on pressure ranges of 10 inH₂O and above

Applications

- Medical Breathing
- Industrial Controls
- HVAC
- Environmental Controls
- Portable Equipment

Pressure Sensor Maximum Ratings		Environmental Specifications	
Supply Voltage (Vs)	3.63 Vdc	Temperature Ranges	
Common Mode Pressure	10 psig	Compensated	0°C to 70°C (Contact Factory for Other Ranges)
Lead Temperature (soldering 2-4 sec.)	270°C	Operating	-40°C to 85°C
Device Temperature (reflow soldering)	245°C	Storage	-40°C to 125°C
		Humidity Limits (non condensing)	0 to 95% RH

Example Circuit

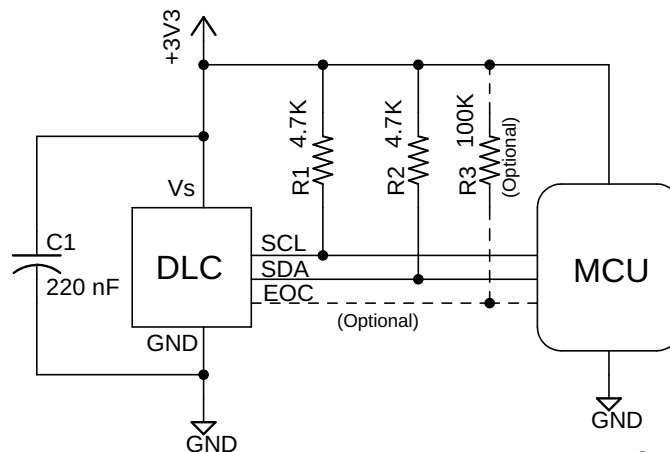

See package drawings for pinouts

Standard Pressure Ranges

Low Pressure Products

Device	Operating Range ^A		Proof Pressure		Burst Pressure	
DLC-L01D	± 1 inH2O	248.84 Pa	100 inH2O	24.88 kPa	300 inH2O	74.65 kPa
DLC-L02D	± 2 inH2O	497.68 Pa	100 inH2O	24.88 kPa	300 inH2O	74.65 kPa
DLC-L05D	± 5 inH2O	1,244.20 Pa	200 inH2O	49.77 kPa	300 inH2O	74.65 kPa
DLC-L10D	± 10 inH2O	2,488.40 Pa	200 inH2O	49.77 kPa	300 inH2O	74.65 kPa
DLC-L20D	± 20 inH2O	4,976.80 Pa	200 inH2O	49.77 kPa	500 inH2O	124.42 kPa
DLC-L30D	± 30 inH2O	7,465.20 Pa	200 inH2O	49.77 kPa	500 inH2O	124.42 kPa
DLC-L60D	± 60 inH2O	14,930.4 Pa	200 inH2O	49.77 kPa	800 inH2O	199.01 kPa
DLC-L01G	0 to 1 inH2O	248.84 Pa	100 inH2O	24.88 kPa	300 inH2O	74.65 kPa
DLC-L02G	0 to 2 inH2O	497.68 Pa	100 inH2O	24.88 kPa	300 inH2O	74.65 kPa
DLC-L05G	0 to 5 inH2O	1,244.20 Pa	200 inH2O	49.77 kPa	300 inH2O	74.65 kPa
DLC-L10G	0 to 10 inH2O	2,488.40 Pa	200 inH2O	49.77 kPa	300 inH2O	74.65 kPa
DLC-L20G	0 to 20 inH2O	4,976.80 Pa	200 inH2O	49.77 kPa	500 inH2O	124.42 kPa
DLC-L30G	0 to 30 inH2O	7,465.20 Pa	200 inH2O	49.77 kPa	500 inH2O	124.42 kPa
DLC-L60G	0 to 60 inH2O	14,930.4 Pa	200 inH2O	49.77 kPa	800 inH2O	199.01 kPa

High Pressure Products

Device	Operating Range ^A		Proof Pressure		Burst Pressure	
DLC-005D	± 5 psi	34.47 kPa	10 psi	68.95 kPa	15 psi	103.42 kPa
DLC-015D	± 15 psi	103.42 kPa	30 psi	206.84 kPa	45 psi	310.26 kPa
DLC-030D	± 30 psi	206.84 kPa	60 psi	413.69 kPa	90 psi	620.53 kPa
DLC-100D	± 100 psi	689.48 kPa	200 psi	1,378.95 kPa	225 psi	1,551.32 kPa
DLC-150D	± 150 psi	1,034.20 kPa	225 psi	1,551.32 kPa	225 psi	1,551.32 kPa
DLC-005G	0 to 5 psi	34.47 kPa	10 psi	68.95 kPa	15 psi	103.42 kPa
DLC-015G	0 to 15 psi	103.42 kPa	30 psi	206.84 kPa	45 psi	310.26 kPa
DLC-030G	0 to 30 psi	206.84 kPa	60 psi	413.69 kPa	90 psi	620.53 kPa
DLC-100G	0 to 100 psi	689.48 kPa	200 psi	1,378.95 kPa	225 psi	1,551.32 kPa
DLC-150G	0 to 150 psi	1,034.20 kPa	225 psi	1,551.32 kPa	225 psi	1,551.32 kPa

Note A: Operating range in Pa is expressed as an approximate value.



Performance Characteristics for DLC Series

ALL PARAMETERS ARE MEASURED AT 3.3V \pm 5% EXCITATION AND 25C UNLESS OTHERWISE SPECIFIED (NOTE 6). PRESSURE MEASUREMENTS ARE WITH POSITIVE PRESSURE APPLIED TO PORT A FOR HIGH PRESSURE DIFFERENTIAL (1xxD, 0xxD) PRODUCTS, AND TO PORT B FOR ALL OTHER GAGE AND DIFFERENTIAL PRODUCTS.

Parameter	Min	Typ	Max	Units	Notes
Output Span (Full Scale Span)					
LxxD (All Packages)	-	$\pm 0.4 * 2^{24}$	-	Dec Counts	1
LxxG (U2 Package)	-	$\pm 0.4 * 2^{24}$	-	Dec Counts	1
LxxG (All Other Packages)	-	$0.8 * 2^{24}$	-	Dec Counts	1
1xxD, 0xxD (All Packages)	-	$\pm 0.4 * 2^{24}$	-	Dec Counts	1
1xxD, 0xxG (All Packages)	-	$0.8 * 2^{24}$	-	Dec Counts	1
Offset Output @ Zero Diff. Pressure ($O_{s_{dig}}$)					
LxxD (All Packages)	-	$0.5 * 2^{24}$	-	Dec Counts	-
LxxG (U2 Package)	-	$0.5 * 2^{24}$	-	Dec Counts	-
LxxG (All Other Packages)	-	$0.1 * 2^{24}$	-	Dec Counts	-
1xxD, 0xxD (All Packages)	-	$0.5 * 2^{24}$	-	Dec Counts	-
1xxD, 0xxG (All Packages)	-	$0.1 * 2^{24}$	-	Dec Counts	-
Total Error Band					
L01G	-	-	± 3.00	%FSS	3
L01D, L02G	-	-	± 2.00	%FSS	3
L02D, L05G, L05D, L10G, L10D, L20G	-	-	± 1.25	%FSS	3
L20D, L30G, L30D, L60G, L60D	-	-	± 1.00	%FSS	3
All Higher Pressure	-	-	± 1.00	%FSS	3
Pressure Digital Resolution - No Missing Codes					
16-bit Option	15.3	15.5	-	bit	-
Temperature Output					
Resolution	-	16	-	bit	-
Overall Accuracy	-	2	-	$^{\circ}$ C	-
Supply Current Requirement					
During Active State (ICC_{Active})	-	2.0	2.5	mA	4, 5, 6
During Idle State (ICC_{Idle})	-	100	250	nA	4, 5, 6
Power On Delay					
	-	-	2.5	ms	4
Data Update time (t_{DU})					
	(see table below)			ms	4, 5

Calibrated Resolution	Measurement Command										Units
	Single		Average2		Average4		Average8		Average16		
	Typ	Max	Typ	Max	Typ	Max	Typ	Max	Typ	Max	
16 bit	3.70	4.1	7.20	8.0	14.20	15.7	28.20	31.1	56.20	61.9	ms

I2C Electrical Parameters for DLC Series

Parameter	Symbol	Min	Typ	Max	Units	Notes
Input High Level	-	80	-	100	% of Vs	6
Input Low Level	-	0	-	20	% of Vs	6
Output Low Level	-	-	-	10	% of Vs	6
I2C Pull-Up Resistor	-	1000	-	-	Ω	6
I2C Load Capacitance on SDA, @ 400kHz	C_{SDA}	-	-	200	pF	6
I2C Input Capacitance (each pin)	C_{I2C_IN}	-	-	10	pF	6
I2C Address	-	-	41	-	decimal	-

Pressure Output Transfer Function

$$\text{Pressure (units)} = 1.x25 \times \left(\frac{\text{Pout}_{dig} - \text{OS}_{dig}}{2^{24}} \right) \times \text{Calibrated Range (units)}$$

Where:

- Pout_{dig}** is the sensor 24-bit output
- OS_{dig}** is the specified digital offset output (see Performance Characteristics Table)
- Calibrated Range (units)** is the sensor Full Scale Span in inH2O
for Gage Operating Range sensors (Except U2 Package): Full Scale Pressure
for Gage Operating Range sensors in U2 Package and Differential Operating Range sensors: 2X Full Scale Pressure

Temperature Output Transfer Function

$$\text{Temperature (°C)} = \left(\frac{\text{Tout}_{dig} * 150}{2^{24}} \right) - 40$$

Where:

- Tout_{dig}** is the sensor 24-bit digital temperature output

Specification Notes

- NOTE 1: THE FULL SCALE SPAN IS THE ALGEBRAIC DIFFERENCE IN OUTPUT AT MAXIMUM AND MINIMUM CALIBRATED PRESSURES, EXPRESSED AS A CHANGE FROM THE OFFSET PRESSURE OUTPUT. FOR DIFFERENTIAL SENSORS THIS WILL BE A BIPOLAR VALUE; FOR GAGE SENSORS THIS WILL BE A POSITIVE VALUE.
- NOTE 2: THE FULL SCALE PRESSURE IS THE MAXIMUM POSITIVE CALIBRATED PRESSURE.
- NOTE 3: TOTAL ERROR BAND CONSISTS OF OFFSET AND SPAN TEMPERATURE AND CALIBRATION ERRORS, LINEARITY AND PRESSURE HYSTERESIS ERRORS, OFFSET WARM-UP SHIFT, AND OFFSET POSITION SENSITIVITY ERRORS.
- NOTE 4: PARAMETER IS CHARACTERIZED AND NOT 100% TESTED.
- NOTE 5: DATA UPDATE TIME IS EXCLUSIVE OF COMMUNICATIONS, FROM COMMAND RECEIVED TO END OF BUSY STATUS. THIS CAN BE OBSERVED AS EOC PIN LOW-STATE DURATION.
- NOTE 6: AVERAGE CURRENT CAN BE ESTIMATED AS : $ICC_{idle} + ((t_{DU} / \text{READING INTERVAL}) * ICC_{ACTIVE})$. REFER TO FIGURE 2 FOR ACTIVE AND IDLE CONDITIONS OF THE SENSOR (THE ACTIVE STATE IS WHILE EOC PIN IS LOW).
- NOTE 7: THE SENSOR IS CALIBRATED WITH A 3.3V SUPPLY, HOWEVER, AN INTERNAL REGULATOR ALLOWS A SUPPLY VOLTAGE OF 1.8V TO 3.6V TO BE USED WITHOUT AFFECTING THE OVERALL SPECIFICATIONS. THIS ALLOWS DIRECT OPERATION FROM A BATTERY SUPPLY.
- NOTE 8: CALIBRATED WITH CONTINUOUS READS.

Soldering Recommendations

- 1) Solder parts as a second operation only.
- 2) For D4, LD2, and LD4 packages post reflow, wait for 72 hrs before performing any calibration operations.
- 3) For all other packages post reflow, wait for 36 hrs before performing any calibration operations.
- 4) Perform spot cleaning as necessary only by hand. **DO NOT** wash or submerge device in cleaning liquid.
- 5) Max 270°C lead temperature (soldering 2-4 sec.)

If these devices are to be subjected to solder reflow assembly or other high temperature processing, they must be baked for 1 hour at 125°C within 24 hours prior to exposure. Failure to comply may result in cracking and/or delamination of critical interfaces within the package, and is not covered by warranty.

Device Ordering Options

Parylene Coating:

Parylene coating provides a moisture barrier and protection from some harsh media. Unlike other pressure sensor suppliers offering a Parylene coating, All Sensors performs this process in-house and uses an advanced production system to achieve the highest accuracy and reliability. This avoids transferring products out of and back to the pressure sensor manufacturing facility, provides complete quality control and improves the delivery time to customers. Specially designed masking techniques allow All Sensors to apply a cost-effective, high-volume Parylene coating in-house.

Consult factory for applicability of Parylene for the target application and sensor type.

This option is only available for pressure ranges of ± 10 inH₂O and above.

Output Resolution

Calibrated output resolution of 16 bits, scaled to 24-bit output.

See the Data Update Time in the Performance Characteristics table.

Operation Overview

The DLC is a digital sensor with a signal path that includes a sensing element, a variable-bit analog to digital converter, a DSP and an IO block that supports an I2C interface (see Figure 1 below). The sensor also includes an internal temperature reference and associated control logic to support the configured operating mode. Since there is a single ADC, there is also a multiplexer at the front end of the ADC that selects the signal source for the ADC.

Figure 1 - DLC Essential Model

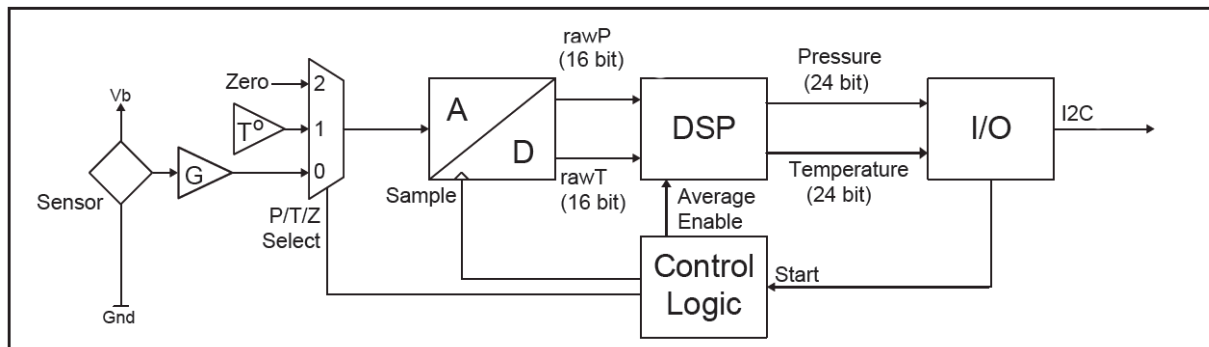

The ADC performs conversions on the raw sensor signal (P), the temperature reference (T) and a zero reference (Z) during the ADC measurement cycle.

The DSP receives the converted pressure and temperature information and applies a multi-order transfer function to compensate the pressure output. This transfer function includes compensation for span, offset, temperature effects on span, temperature effects on offset and second order temperature effects on both span and offset. There is also linearity compensation for gage devices and front to back linearity compensation for differential devices.

Sensor Commands: Five Measurement commands are supported, returning values of either a single pressure / temperature reading or an average of 2, 4, 8, or 16 readings. Each of these commands wakes the sensor from Idle state into Active state, and starts a measurement cycle. For the Start-Average commands, this cycle is repeated the appropriate number of times, while the Start-Single command performs a single iteration. When the DSP has completed calculations and the new values have been made available to the I/O block, the sensor returns to Idle state.

The sensor remains in this low-power state until another Measurement command is received.

Operation Overview cont'd.

After completion of the measurement, the result may then be read using the Data Read command. The ADC and DSP remain in Idle state, and the I/O block returns the 7 bytes of status and measurement data. See Figure 2, following. At any time, the host may request current device status with the Status Read command.

See Table 1 for a summary of all commands.

For optimum sensor performance, All Sensors recommends using the **Start-Average4** measurement command. This results in the best combination of low noise and offset accuracy. For applications requiring different reading modes, such as infrequent single readings, there may be a small constant value of offset shift. This shift can be measured at system startup, and can be removed by the application.

Figure 2 - DLC Communication Model

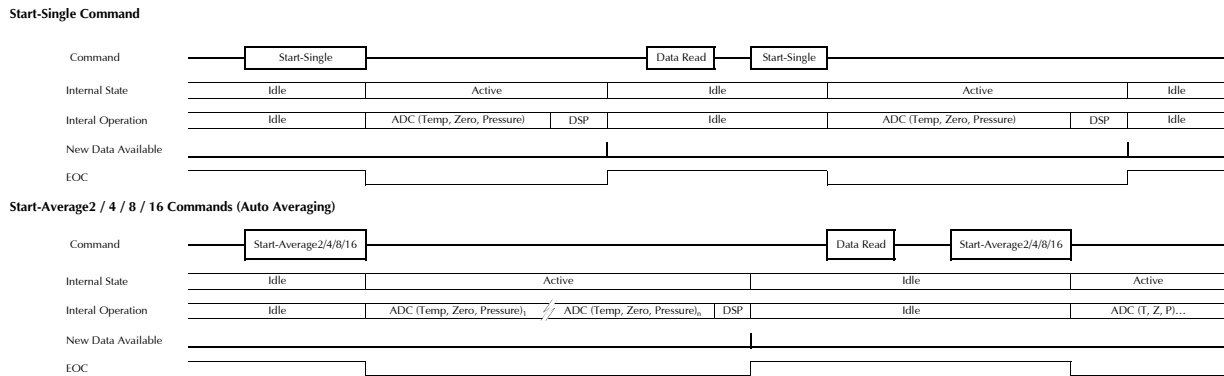

Digital Interface Command Formats

When requesting sensor status over I2C, the host sends a 1-byte command, then performs a 1-byte read transfer.

When reading sensor data over I2C, the host sends a 1-byte command, then performs a 7-byte read transfer.

See Table 1 below for Measurement Commands, Sensor Data read and Sensor Status read details.

Table 1 - DLC Sensor Command Set

Measurement Commands	
Description	I2C
Start-Single	0xAA
Start-Average2	0xAC
Start-Average4	0xAD
Start-Average8	0xAE
Start-Average16	0xAF

Read Sensor Data	
I2C	Read of 7 bytes from device

Read Sensor Status	
I2C	Read of 1 byte from device

Digital Interface Data Format

For either type of digital interface, the format of data returned from the sensor is the same. The first byte consists of the Status Byte followed by a 24-bit unsigned pressure value and a 24-bit unsigned temperature value. Unused bits beyond the calibrated bit width are undefined, and may have any value. See the Pressure Output Transfer Function and Temperature Output Transfer Function definitions on page 3 for converting to pressure and temperature. Refer to Table 2 for the overall data format of the sensor. Table 3 shows the Status Byte definition. Note that a completed reading without error will return status 0x40.

Table 2 - Output Data Format

S[7:0]	P[23:16]	P[15:8]	P[7:0]	T[23:16]	T[15:8]	T[7:0]
Status Byte	Pressure MSB	Pressure Byte 1	Pressure LSB	Temperature MSB	Temperature Byte 1	Temperature LSB

Table 3- Status Byte Definition

Bit	Description
Bit 7 [MSB]	[Always = 0]
6	Power : [1 = Power On]
5	Busy: [1 = Processing Command, 0 = Ready]
4:3	Mode: [00 = Normal Operation]
2	Memory Error [1 = EEPROM Checksum Fail]
1	Sensor Configuration [always = 0]
Bit 0 [LSB]	ALU Error [1 = Error]

I2C Interface

I2C Command Sequence

The part enters Idle state after power-up, and waits for a command from the bus master. Any of the five Measurement commands may be sent, as shown in Table 1. Following receipt of one of these commands, the EOC pin is set to Low level, and the sensor Busy bit is set in the Status Byte. After completion of measurement and calculation in the Active state, compensated data is written to the output registers, the EOC pin is set high, and the processing core goes back to Idle state. The host processor can then perform the Data Read operation, which for I2C is simply a 7-byte Device Read.

If the EOC pin is not monitored, the host can poll the Status Byte by repeating the Status Read command, which for I2C is a one-byte Device Read. When the Busy bit in the Status byte is zero, this indicate that valid data is ready, and a full Data Read of all 7 bytes may be performed.

I2C Interface (Cont'd)

I2C Bus Communications Overview

The I2C interface uses a set of signal sequences for communication. The following is a description of the supported sequences and their associated mnemonics. Refer to Figure 3 for the associated usage of the following signal sequences.

Bus not Busy (I): During idle periods both data line (SDA) and clock line (SCL) remain HIGH.

START condition (ST): A HIGH to LOW transition of SDA line while the clock (SCL) is HIGH is interpreted as START condition. START conditions are always set by the master. Each initial request for a pressure value has to begin with a START condition.

Slave address (An): The I2C-bus requires a unique address for each device. The DLC sensor has a preconfigured slave address (see specification table on Page 3). After setting a START condition the master sends the address byte containing the 7 bit sensor address followed by a data direction bit (R/W). A "0" indicates a transmission from master to slave (WRITE), a "1" indicates a device-to master request (READ).

Acknowledge (A or N): Data is transferred in units of 8 bits (1 byte) at a time, MSB first. Each data-receiving device, whether master or slave, is required to pull the data line LOW to acknowledge receipt of the data. The Master must generate an extra clock pulse for this purpose. If the receiver does not pull the data line down, a NACK condition exists, and the slave transmitter becomes inactive. The master determines whether to send the last command again or to set the STOP condition, ending the transfer.

DATA valid (Dn): State of data line represents valid data when, after a START condition, data line is stable for duration of HIGH period of clock signal. Data on line must be changed during LOW period of clock signal. There is one clock pulse per data bit.

STOP condition (P): LOW to HIGH transition of the SDA line while clock (SCL) is HIGH indicates a STOP condition. STOP conditions are always generated by the master.

Figure 3 - I2C Communication Diagram

1. Measurement Commands: Start-Single (to start reading of single sample):

Start-Single	C7...C0: 0xAA
Start-Average2	C7...C0: 0xAC
Start-Average4	C7...C0: 0xAD
Start-Average8	C7...C0: 0xAE
Start-Average16	C7...C0: 0xAF

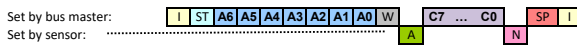

2. Status Read:

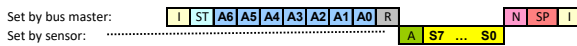

3. Data Read:

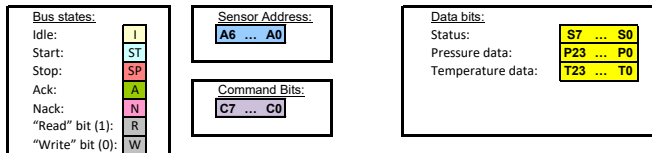
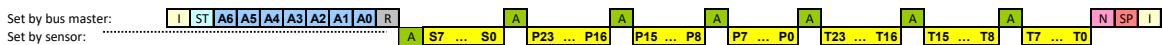

Interface Timing Diagram

Figure 4 - I2C Timing Diagram

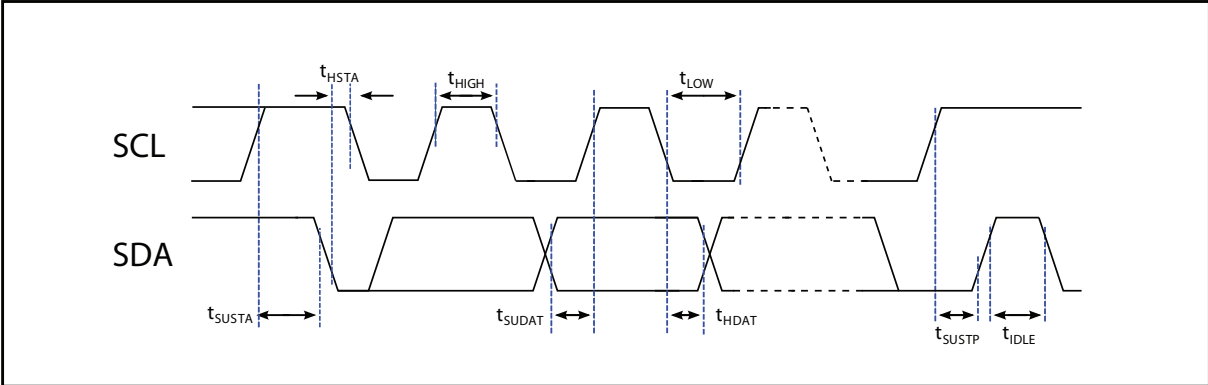

PARAMETER	SYMBOL	MIN	TYP	MAX	UNITS
SCL frequency	f _{SCL}	100	-	400	KHz
SCL low width	t _{LOW}	1.3	-	-	us
SCL high width	t _{HIGH}	0.6	-	-	us
Start condition setup	t _{SUSTA}	0.6	-	-	us
Start condition hold	t _{HSTA}	0.6	-	-	us
Data setup to clock	t _{SUDAT}	0.1	-	-	us
Data hold to clock	t _{HDAT}	0	-	-	us
Stop condition setup	t _{SUSTP}	0.6	-	-	us
Bus idle time	t _{IDLE}	2.0	-	-	us

How to Order

Refer to Table 5 for standard part numbers offered which includes the pressure range and package.

Example P/N with options: DLC-L10D-D4-P

Table 4 - Part Numbering Scheme:

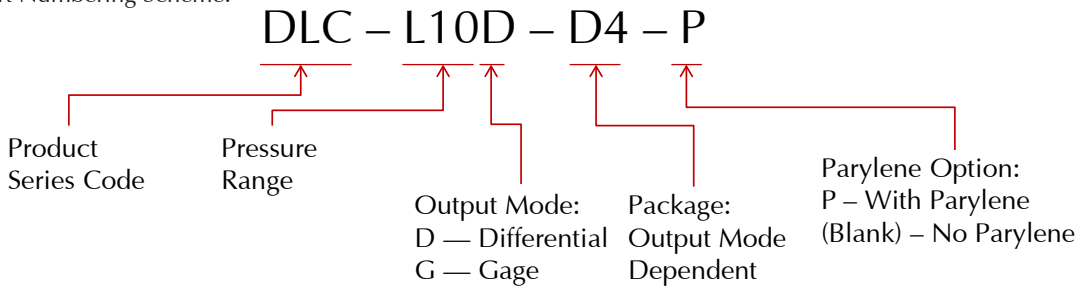

Where:

- Pressure Range (D4, LD2, LD4 Packages): All Differential Pressure Ranges
- Pressure Range (U1, U2 Packages): All Gage Pressure Ranges

The parylene option is only available for pressure ranges of ±10 inH₂O and above.

Example Part Numbers:

- DLC-L10D-D4-P has a Parylene coating
- DLC-L10D-D4 does not have a Parylene coating

How to Order (Cont'd)

Table 5 - Standard Part Number Configurations

D Packages	Low Pressure Products	DLC - L01 D - D4
		DLC - L02 D - D4
		DLC - L05 D - D4
		DLC - L10 D - D4
		DLC - L20 D - D4
		DLC - L30 D - D4
		DLC - L60 D - D4
	High Pressure Products	DLC - 005 D - D4
		DLC - 015 D - D4
		DLC - 030 D - D4
		DLC - 100 D - D4
		DLC - 150 D - D4

LD Packages	Low Pressure Products	DLC - L01 D - LD4	DLC - L01 D - LD2
		DLC - L02 D - LD4	DLC - L02 D - LD2
		DLC - L05 D - LD4	DLC - L05 D - LD2
		DLC - L10 D - LD4	DLC - L10 D - LD2
		DLC - L20 D - LD4	DLC - L20 D - LD2
		DLC - L30 D - LD4	DLC - L30 D - LD2
		DLC - L60 D - LD4	DLC - L60 D - LD2
	High Pressure Products	DLC - 005 D - LD4	DLC - 005 D - LD2
		DLC - 015 D - LD4	DLC - 015 D - LD2
		DLC - 030 D - LD4	
		DLC - 100 D - LD4	
		DLC - 150 D - LD4	

U Packages	Low Pressure Products	DLC - L01 G - U1	DLC - L01 G - U2
		DLC - L02 G - U1	DLC - L02 G - U2
		DLC - L05 G - U1	DLC - L05 G - U2
		DLC - L10 G - U1	DLC - L10 G - U2
		DLC - L20 G - U1	DLC - L20 G - U2
		DLC - L30 G - U1	DLC - L30 G - U2
		DLC - L60 G - U1	DLC - L60 G - U2
	High Pressure Products	DLC - 005 G - U1	DLC - 005 G - U2
		DLC - 015 G - U1	DLC - 015 G - U2
		DLC - 030 G - U1	DLC - 030 G - U2
		DLC - 100 G - U1	DLC - 100 G - U2
		DLC - 150 G - U1	DLC - 150 G - U2

ALL SENSORS

E www.allsensors.com

F 408 225 2079

P 408 225 4314

A 16035 Vineyard Blvd. Morgan Hill, CA 95037



Product Identification for D4, U1, U2, and U4 Packages

All products are labeled via laser marking, as seen in Figure 5.

Figure 6 details how to interpret the part marking code. Low pressure ranges from 1 to 60 inH2O are specified with code “L” and 5 to 150 psi high pressure products with code “H”

The pressure range will be indicated on the same line as the wafer number before the starting character “B.”

If parylene coated, the part will be marked with a “P” on the top. Please refer to package drawings.

Example: DLC-L05D-D4

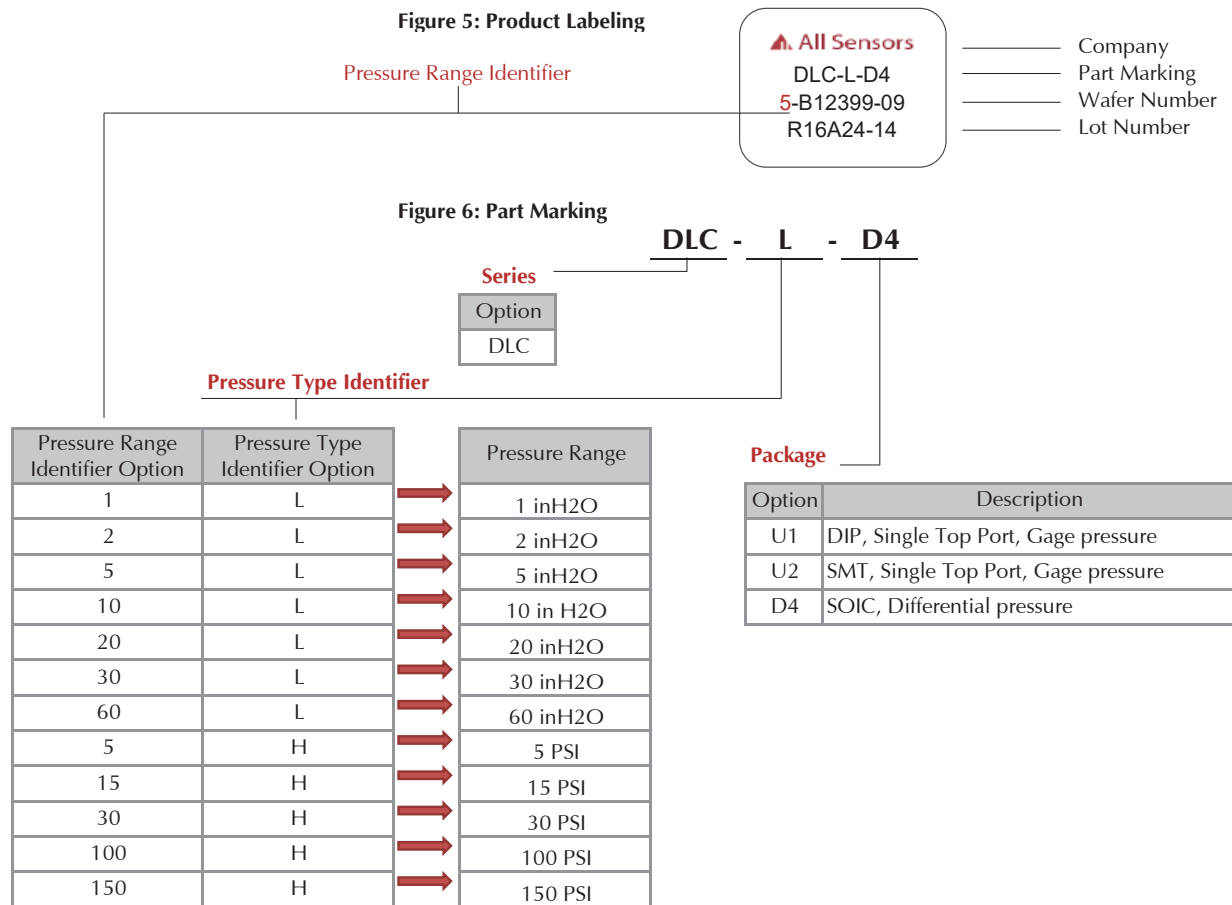

Product Identification for LD2 and LD4 Packages

If parylene coated, the part will be marked with a "P" on the top. Please refer to package drawings.

Example: DLC-L01D-LD2

Figure 7: Product Labeling

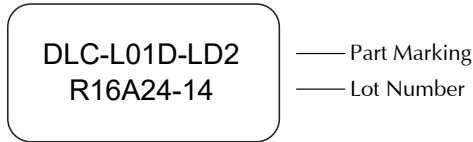
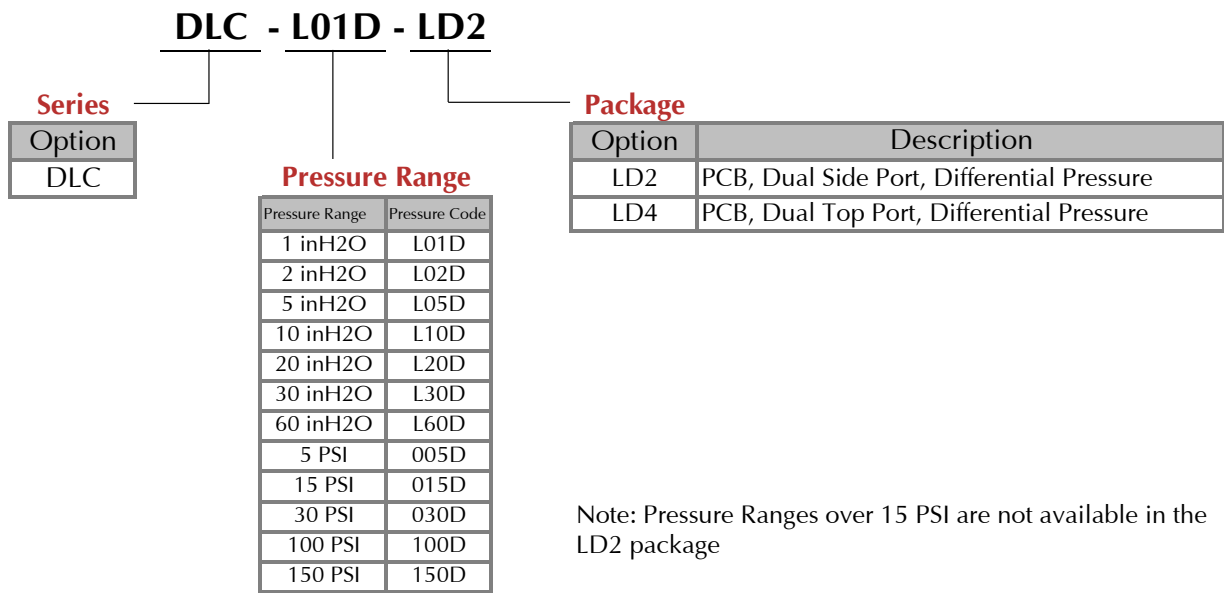
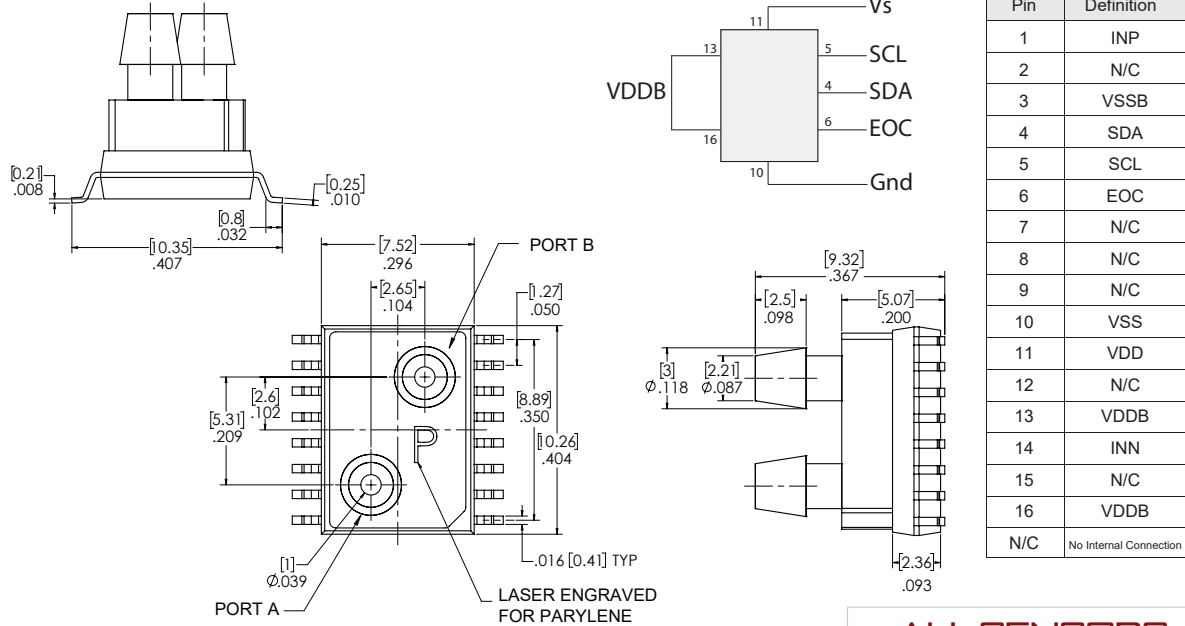

Figure 8: Part Marking



Package Drawings

D4 Package



NOTES

- 1) Dimensions are in inches [mm].
- 2) For suggested pad layout, see drawing: PAD-22.
- 3) Sensors in this package require handling in accordance with MSL3.
- 4) Do not connect any signal to Pins 1, 3, and 14.
- 5) PCB must connect Pin 13 to Pin 16.

ALL SENSORS

TITLE:

D-Series Package

SIZE

FILE NAME

A

D4 Package

Package Drawings (cont'd.)

LD2 Package

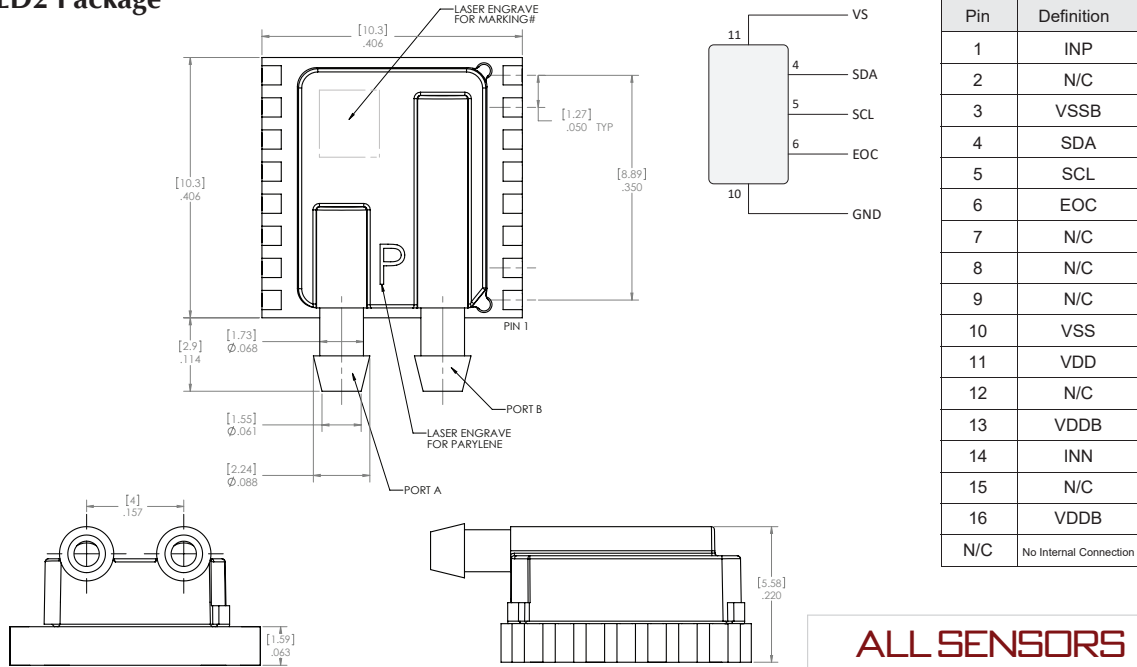

NOTES

- 1) Dimensions are in inches [mm].
- 2) Do not connect any signal to pins 1, 3, or 14.
- 3) For suggested pad layout, see drawing: PAD-22.

ALL SENSORS

TITLE: LD-Series Package

SIZE FILE NAME
A LD2 Package

LD4 Package

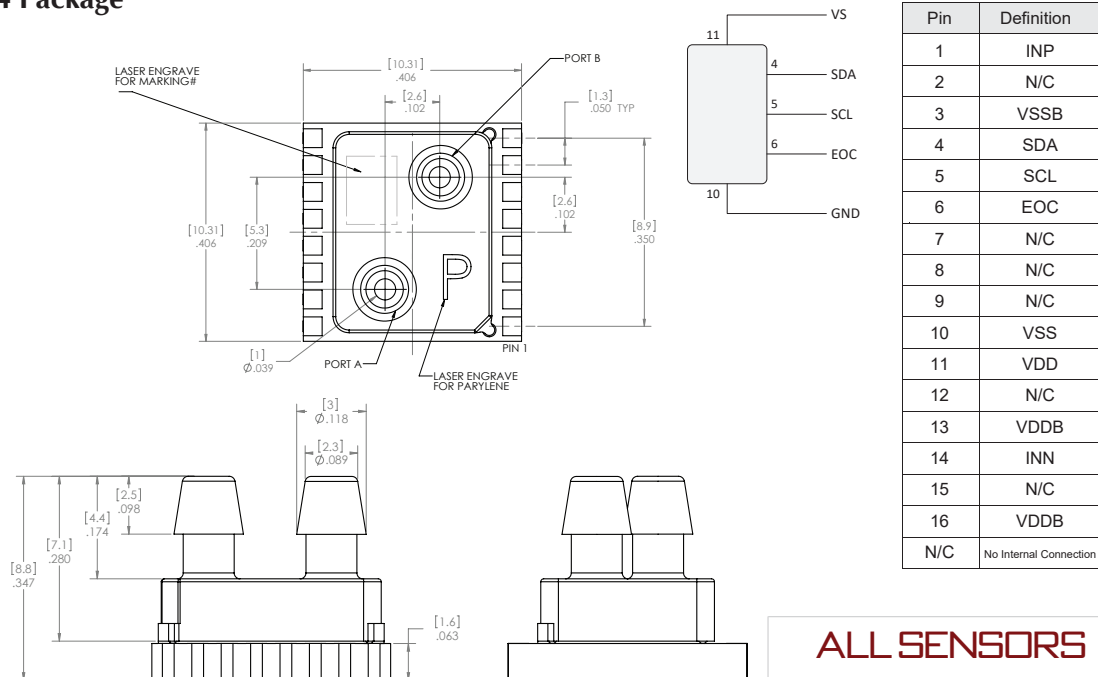

NOTES

- 1) Dimensions are in inches [mm].
- 2) Do not connect any signal to pins 1, 3, or 14.
- 3) For suggested pad layout, see drawing: PAD-22.

ALL SENSORS

TITLE: LD-Series Package

SIZE FILE NAME
A LD4 Package

ALL SENSORS

E www.allsensors.com

F 408 225 2079

P 408 225 4314

A 16035 Vineyard Blvd. Morgan Hill, CA 95037



Package Drawings (cont'd.)

U1 Package

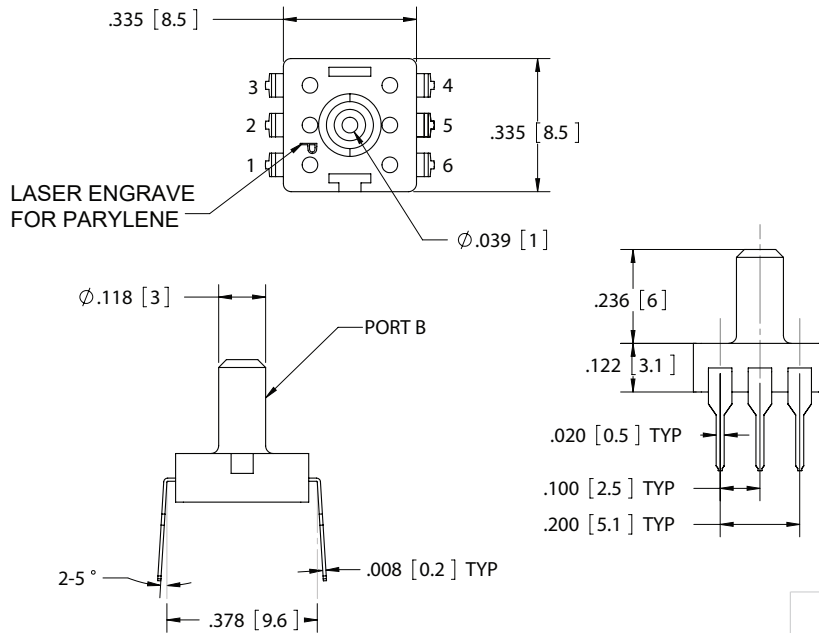

Pin	Definition
1	N/C
2	SCL
3	SDA
4	EOC
5	VDD
6	VSS
N/C	No Internal Connection

NOTES

- 1) Dimensions are in inches [mm].
- 2) For suggested pad layout, see drawing: PAD-23.
- 3) Sensors in this package require handling in accordance with MSL3.

ALL SENSORS

TITLE: U-Series Package

SIZE FILE NAME
A U1 Package

U2 Package

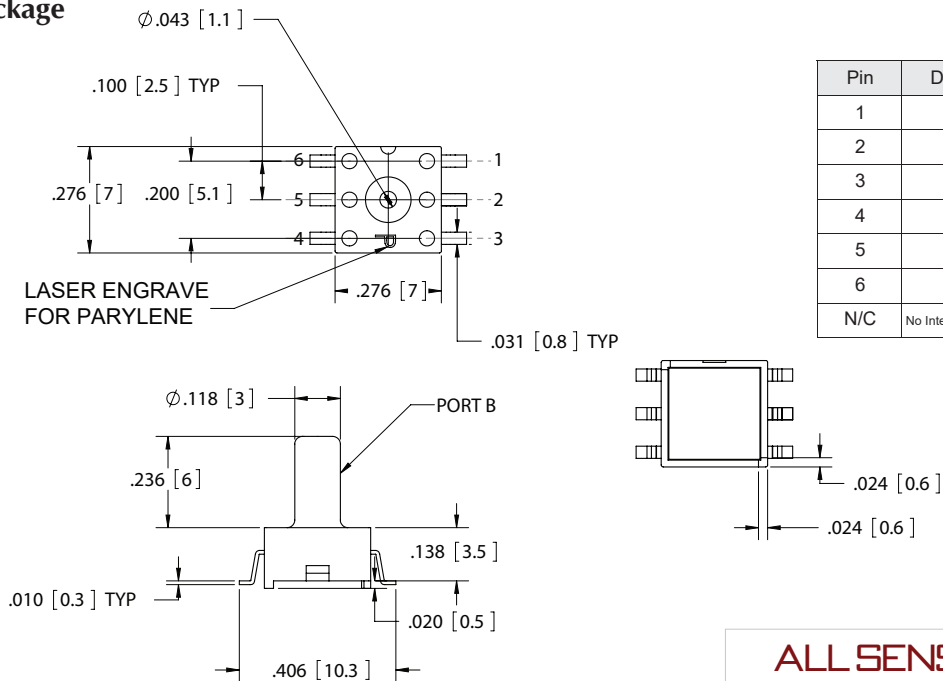

Pin	Definition
1	N/C
2	SCL
3	SDA
4	EOC
5	VDD
6	VSS
N/C	No Internal Connection

NOTES

- 1) Dimensions are in inches [mm].
- 2) For suggested pad layout, see drawing: PAD-24.
- 3) Sensors in this package require handling in accordance with MSL3.

ALL SENSORS

TITLE: U-Series Package

SIZE FILE NAME
A U2 Package

Packing Options



ARROW INDICATES SIDE OF PACKAGE WHERE PIN 1 IS LOCATED

Packages: D4, U1, U2, U4

TRAY

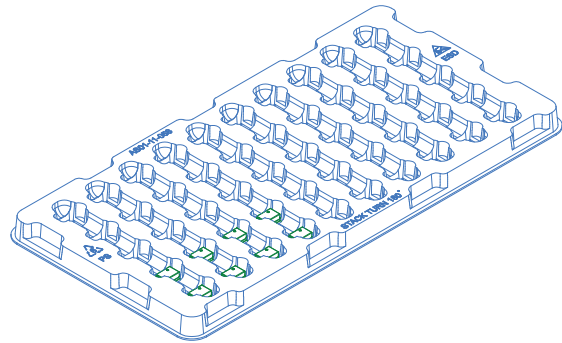

Packages: LD2 and LD4

Notes

- 1) Contact factory for alternate packing options.

Pressure Tubing Recommendations

Tubing Recommendations				
Package Type	ID	OD	Material*	
			Low Pressure	High Pressure
D4	3/32"	5/32"	Silicone	Polyurethane
LD2	1/16"	1/8"	Silicone	Polyurethane
LD4	3/32"	5/32"	Silicone	Polyurethane
U1	3/32"	5/32"	Silicone	Polyurethane
U2	3/32"	5/32"	Silicone	Polyurethane

Suggested Pad Layouts

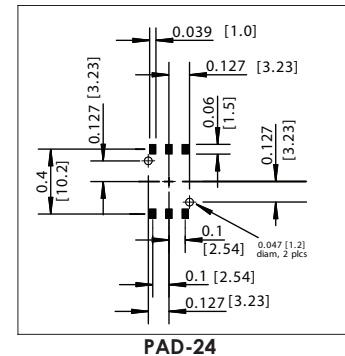
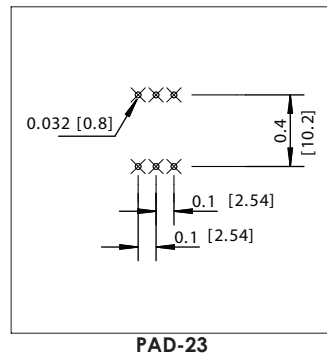
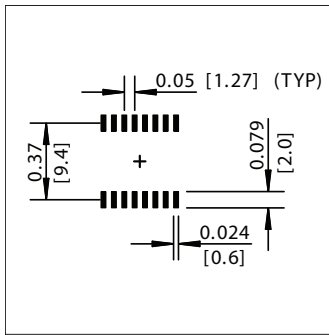

Dimensions are in inches [mm].

All Sensors reserves the right to make changes to any products herein. All Sensors does not assume any liability arising out of the application or use of any product or circuit described herein, neither does it convey any license under its patent rights nor the rights of others.

X-ON Electronics

Largest Supplier of Electrical and Electronic Components

Click to view similar products for [Board Mount Pressure Sensors](#) category:

Click to view products by [Amphenol](#) manufacturer:

Other Similar products are found below :

[6407-249V-17343P](#) [6407-250V-09273P](#) [6407-250V-09343P](#) [80527-25.0H2-05](#) [80541-B00000150-01](#) [80541-B00000200-05](#) [80554-00700100-05](#) [80568-00300050-01](#) [93.631.4253.0](#) [93.731.4353.0](#) [93.932.4553.0](#) [136PC15A1](#) [142PC95AW71](#) [142PC05DW70](#) [15PSI-G-4V1805-01A-L0N-B](#) [26PCBKT](#) [26PCCFA6D26](#) [26PCCFS2G](#) [26PCCVA6D](#) [93.632.7353.0](#) [93.731.3653.0](#) [93.931.4853.0](#) [93.932.4853.0](#) [SDP510-500PA](#) [185PC30DH](#) [20INCH-G-MV-MINI](#) [26PCAFJ3G](#) [26PCCEP5G24](#) [26PCCFJ3G](#) [26PCDFA3G](#) [26PCJEU5G19](#) [30INCH-D1-MV-MINI](#) [ASCX15AN-90](#) [ASCX15AN/SZ76114](#) [4426-015G](#) [4525-DS5A030DP](#) [DCAL401DN](#) [DCAL401GN](#) [4515-DS5A020DP](#) [XZ202798SSC](#) [XZ203676HSC](#) [6407-249V-09273P](#) [6407-249V-09343P](#) [6407-249V-17273P](#) [6407-250V-17273P](#) [6407-250V-17343P](#) [81717-00000050-05](#) [81794-B00001200-01](#) [82681-B00000100-01](#)