

THIS DOCUMENT IS SUBJECT TO CHANGE WITHOUT NOTICE. IT IS CONFIDENTIAL AND A PROPERTY OF AMPHENOL LTW. DISCLOSURE TO THIRD PARTY HAS TO BE AUTHORIZED BY AMPHENOL LTW.

REV.	ECN NO.	DATE	SIGN	DESCRIPTION
A		2022/09/30	Eagle	Rev.01 to Rev.A

DT-HCN-XXRMM-RHA30

For 12P

G3: 3Pin  
G4: 4Pin  
G6: 6Pin  
08: 8Pin  
12: 12Pin

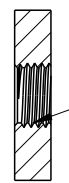
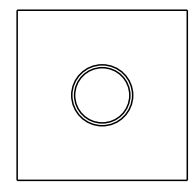
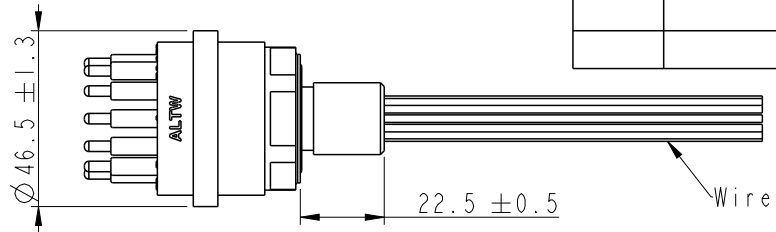

6.40 (Min.)/11.1 (Max.)

Panel cut out (screw type)

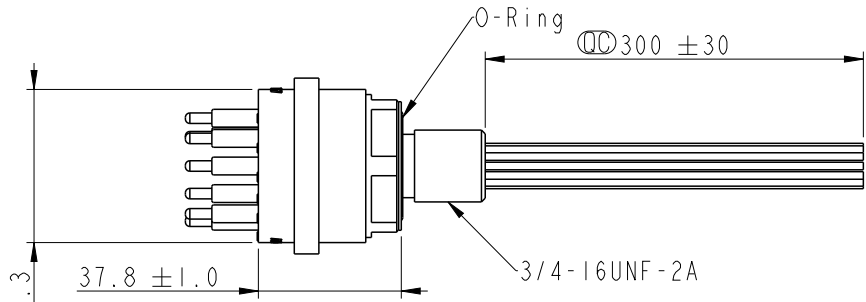
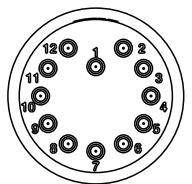

$\phi 20.5 \pm 0.1$

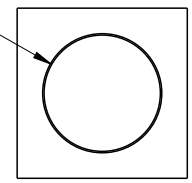

R0.25 (Max.)

6.40 (Min.)/11.1 (Max.)

Panel cut out (hole type)

☉ Date Code (Laser mark)  
YY (年)  
WW (週)  
上下左右置中

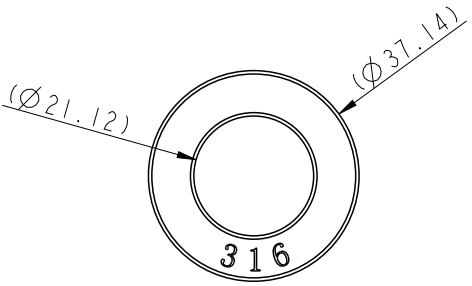

Washer

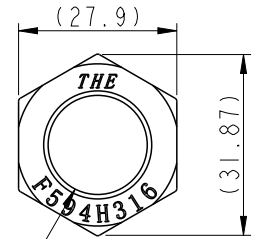

Nut

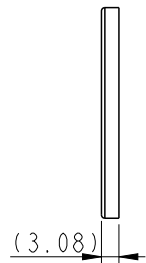

3/4-16UNF-2B

Note:

- \* ☉ Important Dimension.
- \* Waterproof Rate: Hadopelagic 7000M, Mated.
- \* Connector  
Housing : Rubber, Black.  
Pin : Copper Alloy, Gold Plated.  
O-Ring: Rubber, Black.  
Shield: Metal.  
Nut: Metal.  
Washer: Metal.
- \* Wire: UL10393 18 AWG, OD 1.81mm
- \* Washer and nut are packed separately in PE bag.

UNIT: mm		
TOLERANCE ±0.5		

TITLE DT, HAD CIRCULAR MINI REAR FASTENED, M, M			
SCALE 1:1	SIZE A4	SHEET 1 OF 5	
REV. A	WC-REV. A.5	☉: Inspection item	

**Amphenol LTW**  
安費諾亮泰企業股份有限公司

ITEM NO.	DRAWN BY Eagle	DATE 2022/09/30
DWG NO. DT-HCN-XXRMM-RHA30	CHECKED BY Aric	DATE 2022/09/30
CUSTOMER ALTW	APPROVED BY Max	DATE 2022/09/30

THIS DOCUMENT IS SUBJECT TO CHANGE WITHOUT NOTICE. IT IS CONFIDENTIAL AND A PROPERTY OF AMPHENOL LTW. DISCLOSURE TO THIRD PARTY HAS TO BE AUTHORIZED BY AMPHENOL LTW.

For 6P/8P

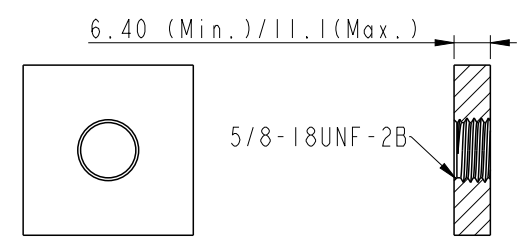
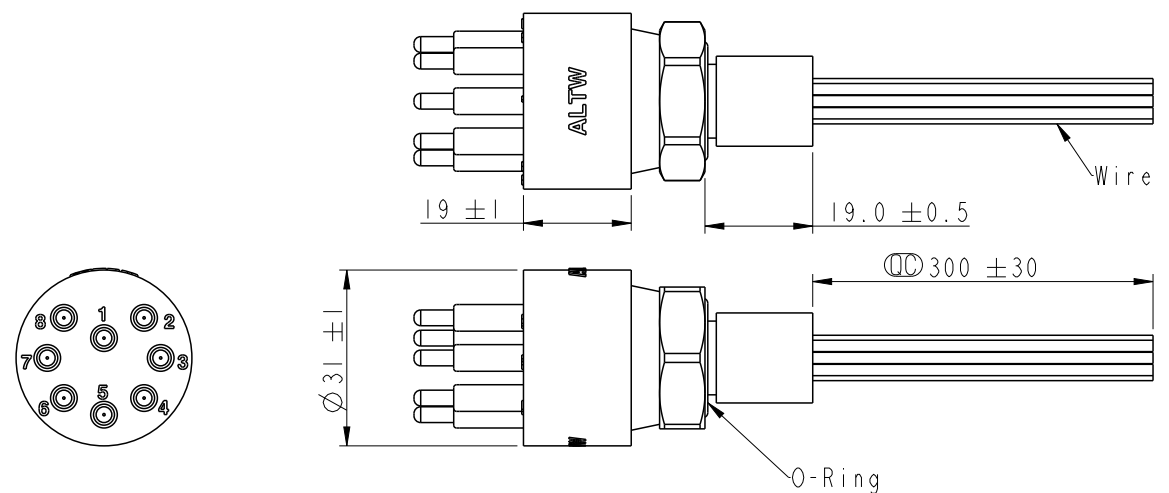

Panel cut out (screw type)

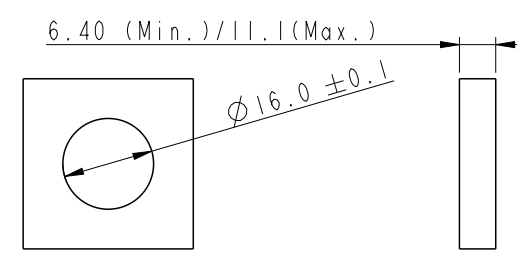

Panel cut out (hole type)

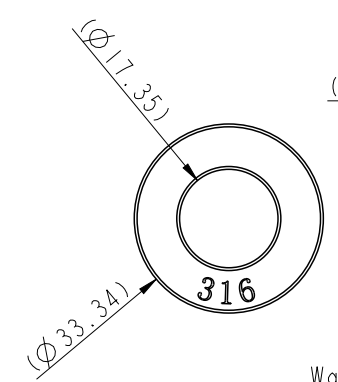
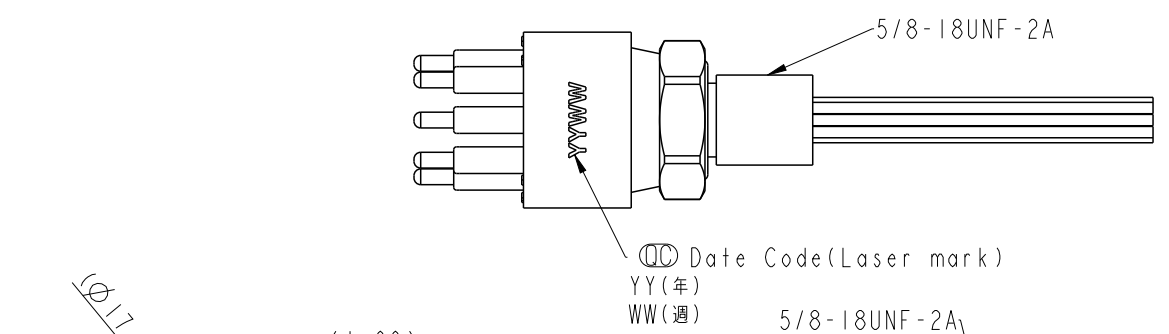

Washer

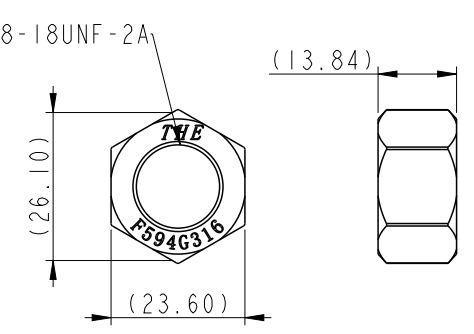

Nut

UNIT: mm TOLERANCE ±0.5	TITLE DT, HAD CIRCULAR MINI REAR FASTENED, M, M		Amphenol LTW 安費諾亮泰企業股份有限公司		ITEM NO	DRAWN BY Eagle	DATE 2022/09/30
	SCALE 1:1	SIZE A4			SHEET 2 OF 5	DWG NO DT-HCN-XXRMM-RHA30	CHECKED BY Aric
	REV. A	WC-REV. A.5	QC: Inspection item	CUSTOMER ALTW	APPROVED BY Max	DATE 2022/09/30	

THIS DOCUMENT IS SUBJECT TO CHANGE WITHOUT NOTICE. IT IS CONFIDENTIAL AND A PROPERTY OF Amphenol LTW. DISCLOSURE TO THIRD PARTY HAS TO BE AUTHORIZED BY Amphenol LTW.

For 3P/4P

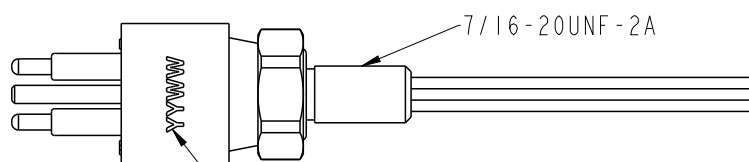
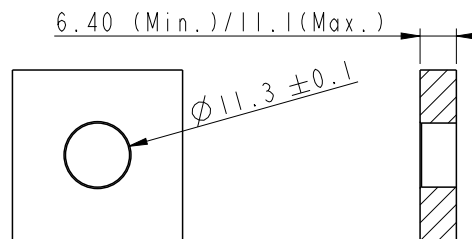
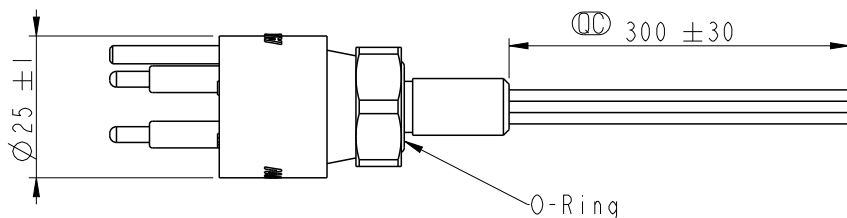
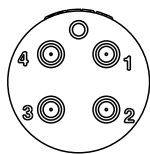
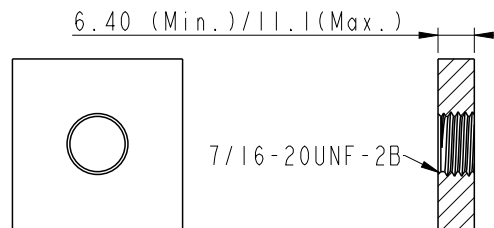
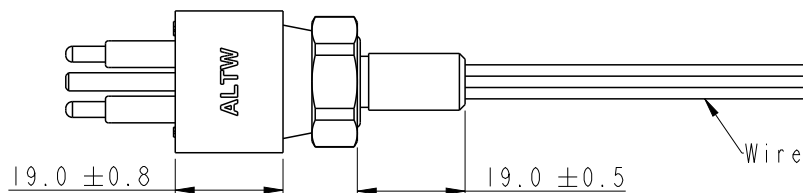

☉ Date Code(Laser mark)  
YY(年)  
WW(週)

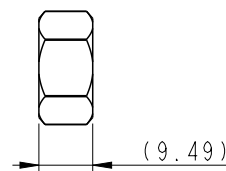
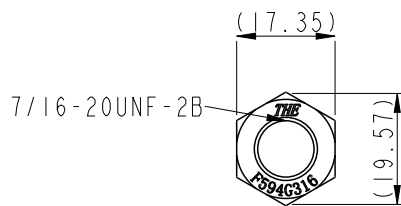
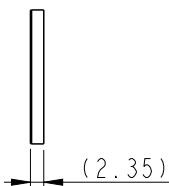
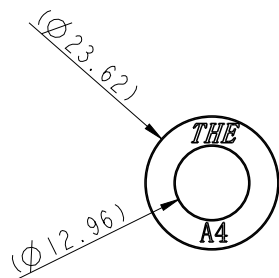

Washer

Nut

UNIT:mm  
TOLERANCE  
±0.5

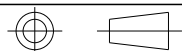

TITLE DT, HAD CIRCULAR MINI REAR FASTENED, M, M			
SCALE 1:1	SIZE A4	SHEET 3 OF 5	
REV. A	WC-REV. A.5	☉: Inspection item	

**Amphenol LTW**  
安費諾亮泰企業股份有限公司

ITEM NO	DRAWN BY Eagle	DATE 2022/09/30
DWG NO DT-HCN-XXRMM-RHA30	CHECKED BY Aric	DATE 2022/09/30
CUSTOMER ALTW	APPROVED BY Max	DATE 2022/09/30

THIS DOCUMENT IS SUBJECT TO CHANGE WITHOUT NOTICE. IT IS CONFIDENTIAL AND A PROPERTY OF Amphenol LTW. DISCLOSURE TO THIRD PARTY HAS TO BE AUTHORIZED BY Amphenol LTW.

1 2 3 4 5 6 7 8

F  
E  
D  
C  
B  
A

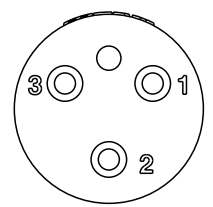

Pin Assignment(Front View)

- Pin Out (3P)  
 1 Black(黑) 18AWG  
 2 White(白) 18AWG  
 3 Red(紅) 18AWG

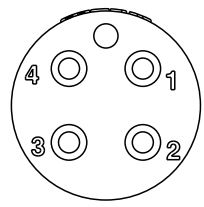

Pin Assignment(Front View)

- Pin Out (4P)  
 1 Black(黑) 18AWG  
 2 White(白) 18AWG  
 3 Red(紅) 18AWG  
 4 Green(綠) 18AWG

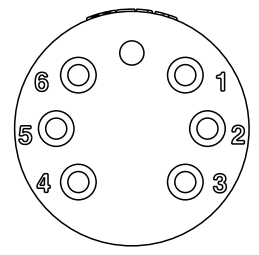

Pin Assignment(Front View)

- Pin Out (6P)  
 1 Black(黑) 18AWG  
 2 White(白) 18AWG  
 3 Red(紅) 18AWG  
 4 Green(綠) 18AWG  
 5 Orange(橙) 18AWG  
 6 Blue(藍) 18AWG

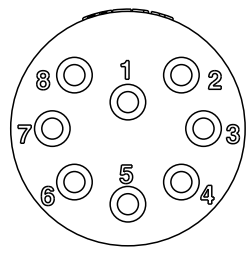

Pin Assignment(Front View)

- Pin Out (8P)  
 1 Black(黑) 18AWG  
 2 White(白) 18AWG  
 3 Red(紅) 18AWG  
 4 Green(綠) 18AWG  
 5 Orange(橙) 18AWG  
 6 Blue(藍) 18AWG  
 7 White/Black(白/黑) 18AWG  
 8 Red/Black(紅/黑) 18AWG

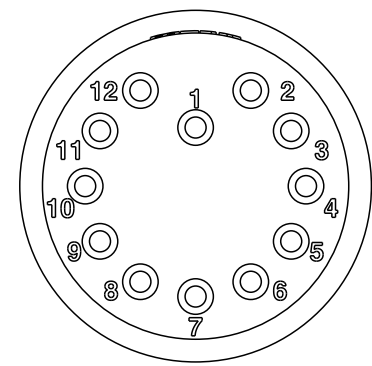

Pin Assignment(Front View)

- Pin Out (12P)  
 1 Black(黑) 18AWG  
 2 White(白) 18AWG  
 3 Red(紅) 18AWG  
 4 Green(綠) 18AWG  
 5 Orange(橙) 18AWG  
 6 Blue(藍) 18AWG  
 7 White/Black(白/黑) 18AWG  
 8 Red/Black(紅/黑) 18AWG  
 9 Green/Black(綠/黑) 18AWG  
 10 Orange/Black(橙/黑) 18AWG  
 11 Blue/Black(藍/黑) 18AWG  
 12 Black/White(黑/白) 18AWG

UNIT:mm  
 TOLERANCE

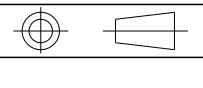

TITLE  
 DT, HAD CIRCULAR MINI  
 REAR FASTENED, M, M

**Amphenol LTW**  
 安費諾亮泰企業股份有限公司

ITEM NO  
 DWG NO  
 CUSTOMER

DRAWN BY  
 CHECKED BY  
 APPROVED BY

DATE  
 DATE  
 DATE

SCALE 1:2  
 SIZE A4  
 SHEET 4 OF 5  
 REV. A  
 WC-REV.  
 Inspection item

DT-HCN-XXRMM-RHA30  
 ALTW

Eagle  
 Aric  
 Max

2022/09/30  
 2022/09/30  
 2022/09/30

1 2 3 4 5 6 7 8 W10814-03-01A2

THIS DOCUMENT IS SUBJECT TO CHANGE WITHOUT NOTICE. IT IS CONFIDENTIAL AND A PROPERTY OF Amphenol LTW. DISCLOSURE TO THIRD PARTY HAS TO BE AUTHORIZED BY Amphenol LTW.

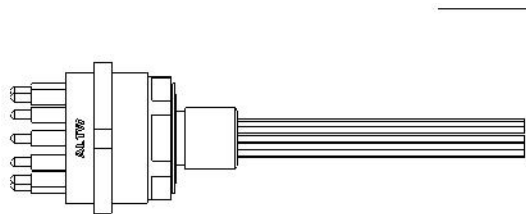

3P/4P/6P/8P: 10PCS(Max.)  
12P: 8PCS(Max.)

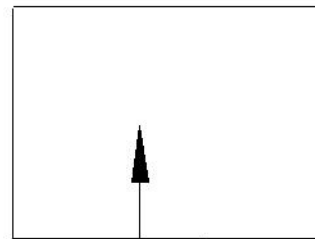

Tray

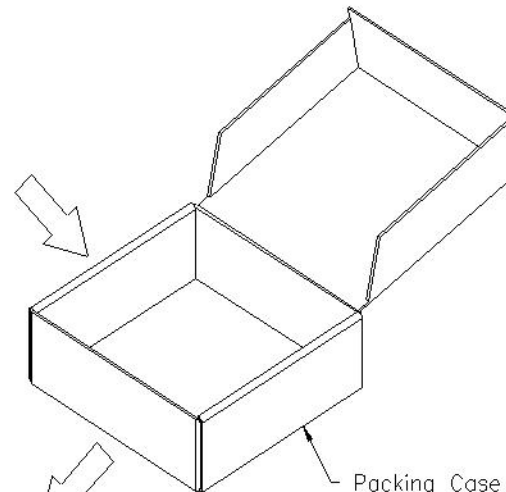

Packing Case

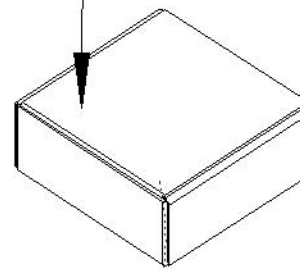

年 月 ALTW 合格品 RoHS2.0

料號: \_\_\_\_\_ 廠商: 昆山安費諾正日電子

數量: \_\_\_\_\_ PC 日期: \_\_\_\_\_

Lot No: \_\_\_\_\_ 版本: \_\_\_\_\_

採購單號: \_\_\_\_\_

廠商料號: \_\_\_\_\_

UNIT: mm  
TOLERANCE  
±0.5

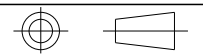

TITLE DT, HAD CIRCULAR MINI REAR FASTENED, M, M			
SCALE 1:1	SIZE A4	SHEET 5 OF 5	
REV. A	WC-REV. A.5	QC: Inspection item	

**Amphenol LTW**  
安費諾亮泰企業股份有限公司

ITEM NO	DRAWN BY Eagle	DATE 2022/09/30
DWG NO DT-HCN-XXRMM-RHA30	CHECKED BY Aric	DATE 2022/09/30
CUSTOMER ALTW	APPROVED BY Max	DATE 2022/09/30

## X-ON Electronics

Largest Supplier of Electrical and Electronic Components

*Click to view similar products for [Specialised Cables](#) category:*

*Click to view products by [Amphenol](#) manufacturer:*

Other Similar products are found below :

[0047002](#) [0047003](#) [0047007](#) [0047104](#) [0047105](#) [0048001](#) [0048003](#) [0048005](#) [0048006](#) [0048007](#) [0049001](#) [0049006](#) [0049104](#) [0049105](#)  
[0049106](#) [00-4951](#) [00-4975](#) [00-4980](#) [00-4982](#) [00-4985](#) [00-4986](#) [00-4987](#) [00-4990](#) [00-4991](#) [00-4994](#) [0050000](#) [0050001](#) [0050002](#) [0050005](#)  
[0050007](#) [0050104](#) [00-5071](#) [0051000](#) [0051001](#) [0051002](#) [0051003](#) [0051007](#) [0051009](#) [0051104](#) [0051105](#) [0051106](#) [0052000](#) [0052001](#)  
[0052002](#) [0052005](#) [0052006](#) [0052104](#) [0052106](#) [00-5267](#) [0053000](#)