

THIS DOCUMENT CONTAINS PROPRIETARY INFORMATION AND SUCH INFORMATION MAY NOT BE DISCLOSED TO OTHERS FOR ANY PURPOSE OR USED FOR MANUFACTURING PURPOSES WITHOUT WRITTEN PERMISSION FROM AMPHENOL CANADA CORP.



DATE	MAY13/05
DRAWN	K. LAMBIE
DESIGNED	
CHECKED	
TITLE	
FCB17 SERIES FILTERED D-SUB CONNECTOR, PIN & SOCKET, VERTICAL MOUNT PCB TAIL, VARIOUS MOUNTING OPTIONS, ROHS COMPLIANT	
DWG. NO.	
ENG. REL. NO.	
REF. EAR #12744	
DIMENSIONS ARE IN	INCHES [mm]
CODE ID. NO.	03554
SCALE	3/1
WT.	
SURF.	
SHEET 2 OF 3	

AMPHENOL Canada Corp.

MOUNTING CODE 9

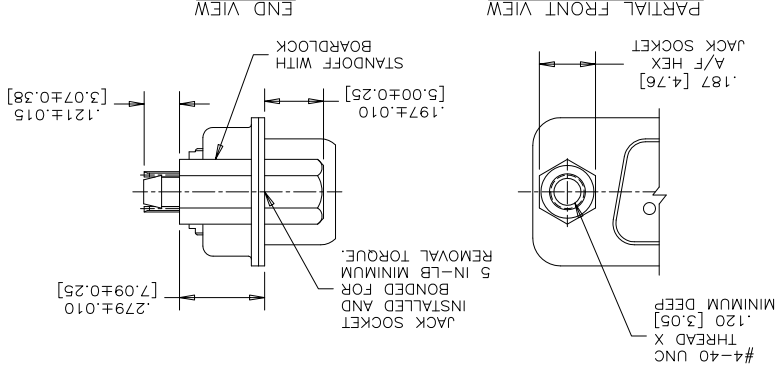

MOUNTING CODE 3

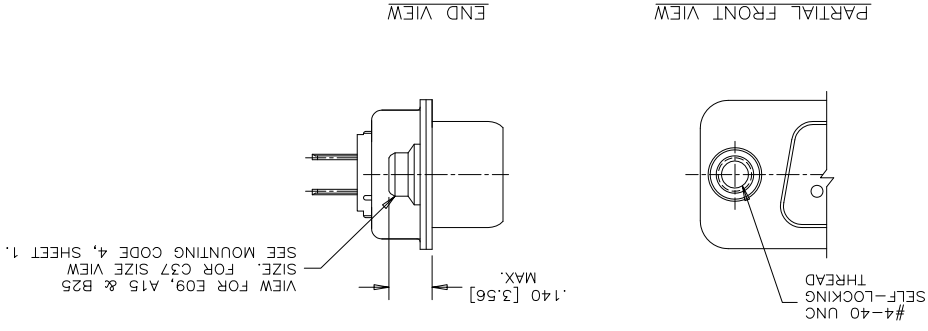

MOUNTING CODE 5

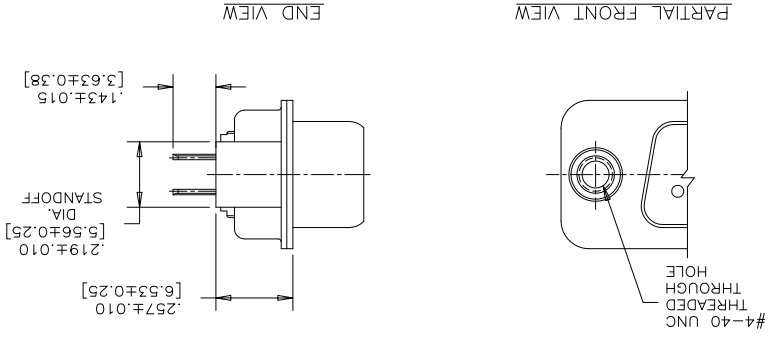

MOUNTING CODES A & J

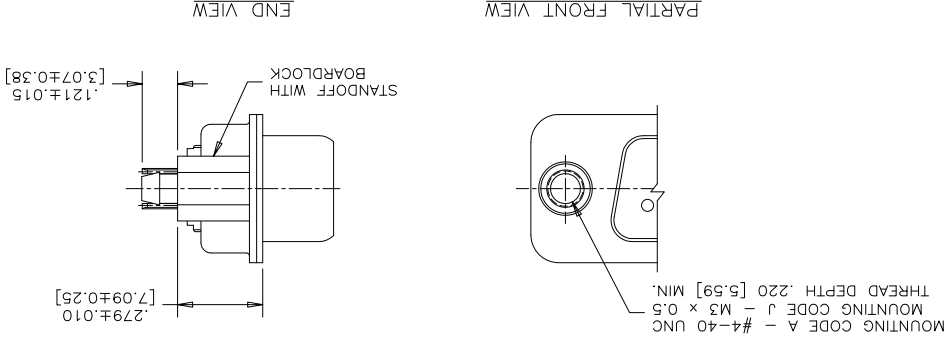

ADDITIONAL MOUNTING OPTIONS AVAILABLE FOR PIN OR SOCKET CONNECTOR

REVISIONS	
REV	ECN, ERN NO., DATE, APPRD.
C	PRODUCT DRAWING (EAR 14498) NOV11/16 K.L.

THIS DOCUMENT CONTAINS PROPRIETARY INFORMATION AND SUCH INFORMATION
MAY NOT BE DISCLOSED TO OTHERS FOR ANY PURPOSE OR USED FOR MANUFACTURING
PURPOSES WITHOUT WRITTEN PERMISSION FROM AMPHENOL CANADA CORP.



DATE	MAT13/05	DESIGNED	CHECKED	L. E. APPRD.	Q. A. APPRD.	DWG. APPRD.	ENG. REL. NO.	DWG. NO.	DWG. DRAWING NO.	REV. C
TITILE FCE17 SERIES FILTERED D-SUB CONNECTOR, PIN & SOCKET, VERTICAL MOUNT PCB TAIL, VARIOUS MOUNTING OPTIONS, ROHS COMPLIANT										
REF. EAR #12744 DIMENSIONS ARE IN INCHES [mm] SCALE 3/1 SURF. ----- SHEET 3 OF 3										

Amphenol Canada Corp.

MATING FACE VIEWS
SHOWING CONTACT POSITION NUMBERS

37 SIZE
PIN

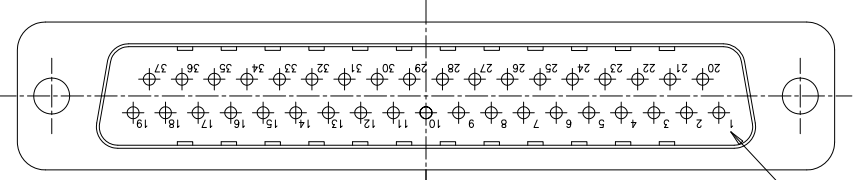

37 SIZE
SOCKET

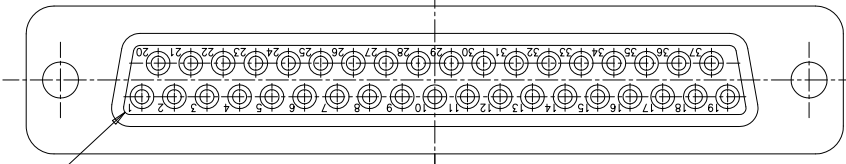

25 SIZE
PIN

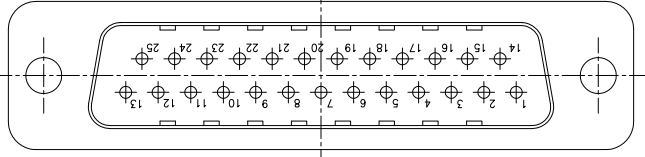

25 SIZE
SOCKET

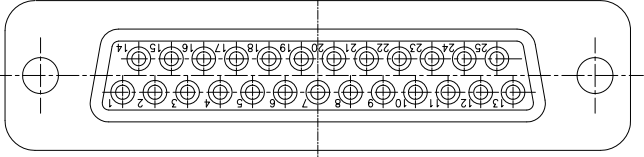

15 SIZE
PIN

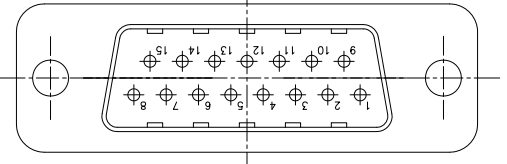

15 SIZE
SOCKET

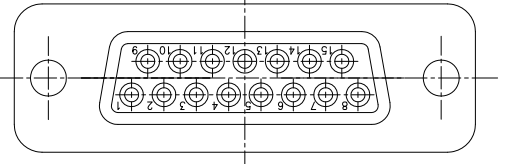

9 SIZE
PIN

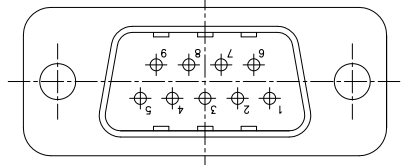

9 SIZE
SOCKET

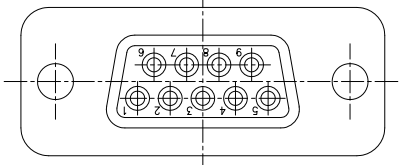

REVISIONS	
REV	ECN, ERN NO.
DATE	APPRD.
PRODUCT DRAWING (EAR 14498)	NOV11/16
G	K.L.

X-ON Electronics

Largest Supplier of Electrical and Electronic Components

Click to view similar products for [D-Sub Standard Connectors](#) category:

Click to view products by [Amphenol](#) manufacturer:

Other Similar products are found below :

[DCM37S732N](#) [DAM15P500](#) [DEV09S364GTLF](#) [DEM09P032N](#) [DDM50P732N](#) [DAM15S332N](#) [173109-2218](#) [173109-2466](#) [173109-2436](#)
[173109-2435](#) [56F706-005-LI](#) [56F711-015](#) [015-0341-000](#) [015-0372-008](#) [015-8544-011](#) [017041-0005](#) [012-0515-000](#) [012-9507-034](#) [012-9507-](#)
[114](#) [012-9534-001](#) [020745-0008](#) [609-25P](#) [M24308/2-23Z](#) [M243082310F](#) [M243082410F](#) [M243082411F](#) [M24308/4-21](#) [CT1A18-11PSA206](#)
[CT1N36-5SC](#) [CT2-16S-17PS](#) [CT2-20-15PCAU](#) [CT2-24-12PS](#) [CT2-24-28PSF127A206](#) [CT2-32-9PC](#) [CT6F9767-14-4-14S-5PC](#)
[CT6FA10SL-4PS](#) [CT7-18-10SC](#) [CT7-18-10SCAU](#) [CT7-18-12SCAU](#) [CT7-18-1PC](#) [CT7-18-1PCAU](#) [CT7-18-21SCAU](#) [M83513/01-FC](#)
[M83723/76W24619 L/C](#) [M85049/48-3-2F](#) [69001-865](#) [6STD09PCM99B70X](#) [6STD09SCT99S40X](#) [6STD15PCT99S40X](#)
[6STD15SCM99B30X](#)