

FW FIELD TV

IEEE 1394 Connection System for Harsh Environments



Description

FW Field allows you to use a standard IEEE1394 connection in harsh environments:

- Sealed against fluids and dusts (IP67)
- Shock, vibration and traction resistant
- No timely in-field cabling operation necessary
- No assembly tools required
- Improved EMI protection

With FW Field, you can insert most **standard IEEE 1394 cordsets** into our metallic plug shell to protect it from shocks, dust and fluids.

No hazardous in-field cabling and grounding required!

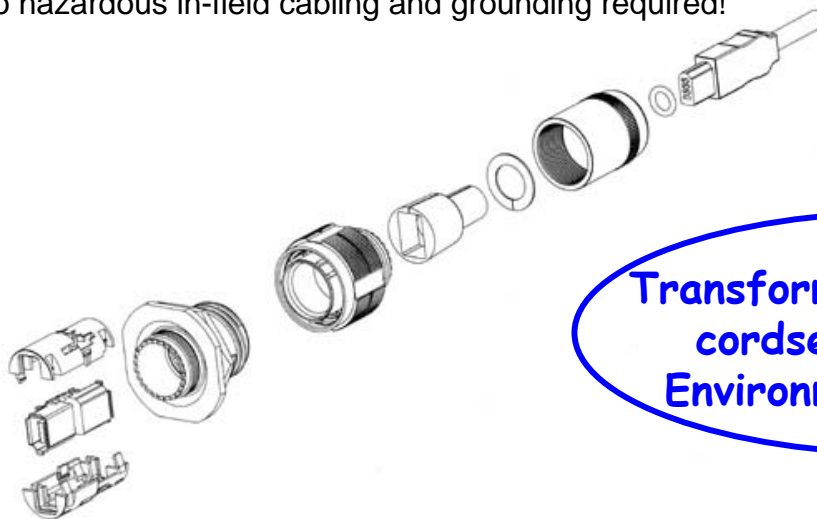

**Transform your IEEE 1394
cordset into a Harsh
Environment Connector !**

The metallic plug connects into the receptacle using a Tri-Start Thread coupling mechanism (MIL-DTL-38999 series III type) with an anti-decoupling device for high vibrations.

On the receptacle side, an IEEE 1394 receptacle is soldered onto a PCB with the following back terminations:

- another IEEE 1394 receptacle
- solder board with 6 tined holes to solder your wires

Standard cordset shielding is transmitted to the IEEE 1394 receptacle through grounding fingers.

For added EMI protection, the shells are conductively plated (Ni, Cd) and have metallized receptacle inserts which transmit the shielding to the connector shells and then the panel.

Applications

- Embedded Computers
 - Data Acquisition and Transmission in harsh environments
- For :
- Railways
 - Battelfield Communication Systems
 - Naval & Shipboard Systems
 - Robotics & Automation
 - Process Control
 - Rugged Communications

DOC-000051-ANG REV-D Nov. 2004

Amphenol®

Main Characteristics

Data Transmission

- IEEE 1394a – 2000

Data rate

400 Mbits/second over 4.5 meters

Mechanical

- Tri-start thread coupling mechanism (MIL-DTL-38999 series III type) with anti-decoupling device
- FW plug retention in the receptacle : 100 N in the axis
- Mating cycles : 500 to 1500 times

Environmental Protection

- Sealing (mated) : IP67 (Temporary immersion - 1M up to 30 minutes)
- Salt Spray : 48 hr with Nickel plating
500 hr with Olive Drab Cadmium
- Fire Retardant / Low Smoke : UL94 V0 and NF F 16 101 & 16 102
- Vibrations : 10 – 500 Hz, 10 g, 3 axes : no discontinuity > 1micro s
- Shocks : IK06 : weight of 250 g drop from 40 cm [15.75 in] onto connectors (mated pair)
- Humidity : 21 days, 43°C, 98% humidity
- Temperature Range : - 55°C / +85°C

Can be used with most IEEE 1394 cordset brands : No tools required!

Assembly Instructions

Plug Assembly

1. If a fully sealed (IP67) assembly is required: Install the white tape around the plug to cover the 4 holes of the overmolding. If there are no holes omit this step.
2. **Insert the black O Ring around the front face of the IEEE 1394 plug. This O Ring will ensure the seal.**
3. Insert the IEEE 1394 cordset into the metallic backshell.
4. Insert laterally onto the cable the retention spacer (this spacer is soft so as to adapt to various overmolding styles) and slide the IEEE 1394 plug into this retention spacer.
5. Insert the friction ring laterally onto the cable cordset.
6. Insert the IEEE 1394 plug into the metallic circular shell. Note at this step that the main key is used for polarization.
7. Screw the backshell on the plug body. A spanner may be required to fully close the backshell to the circular shell.

Important Note : The sealing of the connector is not done by the black retention spacers which are slotted, but rather by the front face O-Ring (Fig 2).

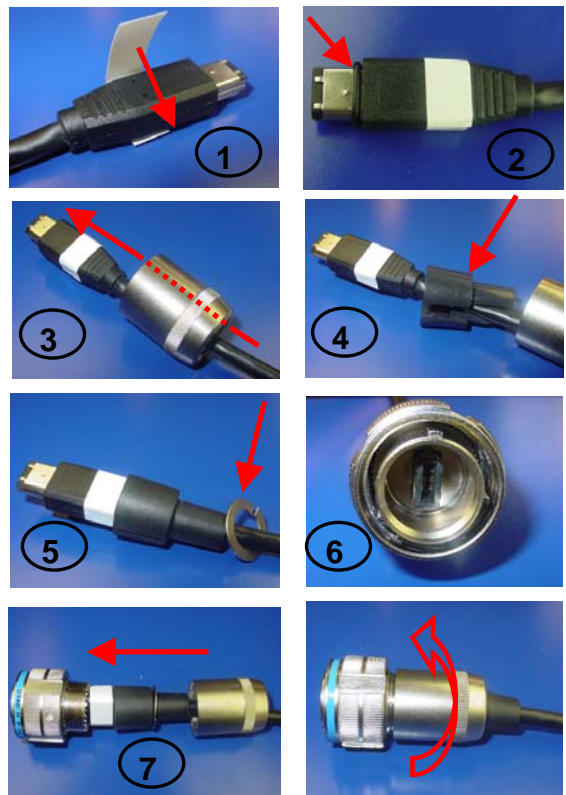

Receptacle Assembly

(For Solder back-termination Styles only)

To Solder your cable onto the PCB :

1. Attach the 2 metallized plastic inserts around the PCB (Fig 1a & 1b).
2. Insert the IEEE 1394 module from the rear of the connector.

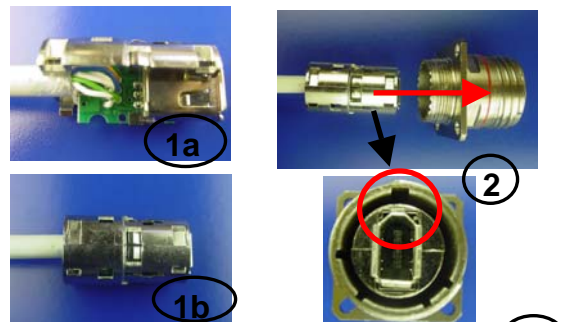

Removing Modules

1. Insert the removal tool **FWF ODE** from the front
2. Push the module back with thumb.



Plug :

« 6 » Shell

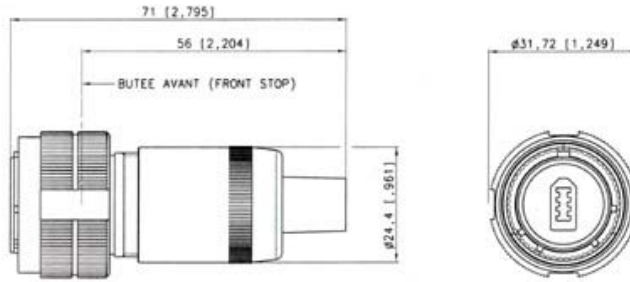

Receptacles :

« 2 » Shell

Square Flange

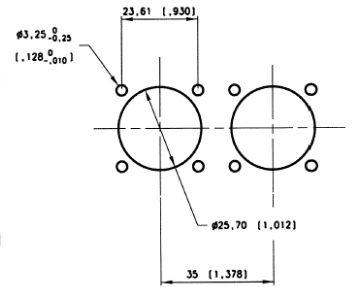
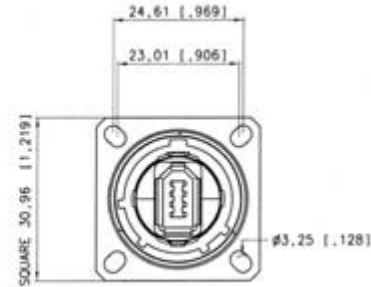
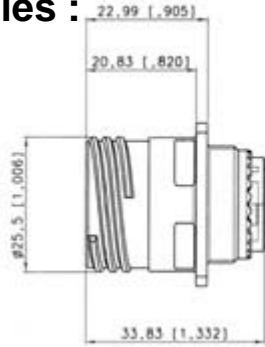

Panel Drilling

« 7 » Shell

Jam Nut

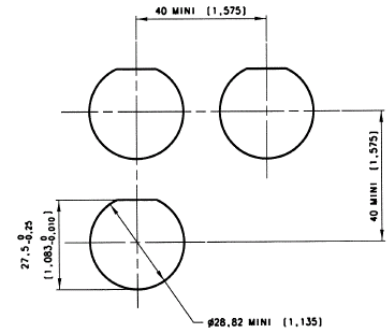
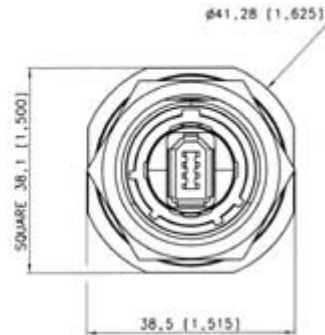
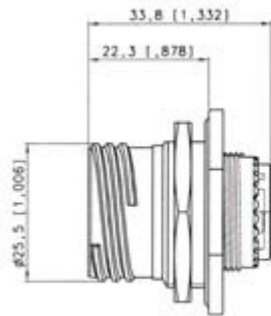

Panel Drilling

« 2PE » and « 7PE » Shells

with Backshell to protect the termination from dust, shocks and vibration.

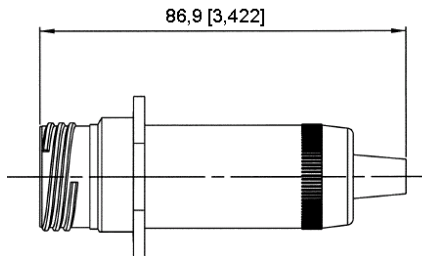

Backshell used with IEEE 1394 Receptacle with back-termination - (Type 1) Non sealed version

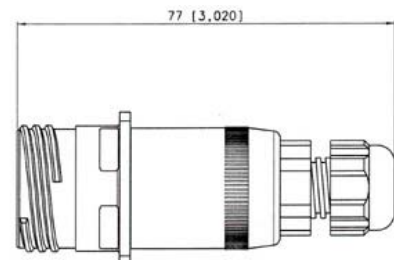

Backshell used with PCB Receptacle back-termination - (Type 2) Sealed version - IP67

Back Terminations :

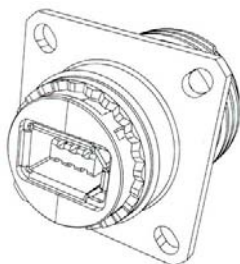

Type 1 : IEEE 1394 Receptacle



Type 2 : Solder 6 Tined holes for soldering

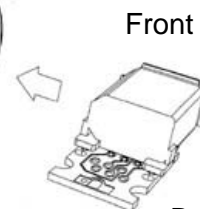

Back

View of the PCB Type 2 version - with 6 tined holes for solder termination

Part Number Code

| | | | | |
|---|---------|---|---|---|
| IEEE 1394 Field TV | FW F TV | 2 | 1 | G |
| Shell Type | | | | |
| 6 : Plug | | | | |
| 2 : Square Flange Receptacle | | | | |
| 2PE : Square Flange Receptacle with backshell | | | | |
| 7 : Jam Nut Receptacle | | | | |
| 7PE : Jam Nut Receptacle with backshell | | | | |
| Back Terminations (Receptacles only) | | | | |
| 1 : IEEE 1394 receptacle | | | | |
| 2 : Solder Board (6 tined holes) | | | | |
| Shell Plating | | | | |
| N : Nickel | | | | |
| G : Olive Drab Cadmium | | | | |

- Examples :
- Olive Drab Cadmium Plug : **FWF TV 6G**
 - Olive Drab Cadmium Square Flange Receptacle, IEEE 1394 front & back : **FWF TV 21G**
 - Olive Drab Cadmium Jam Nut Receptacle, IEEE 1394 front and back : **FWF TV 71G**
 - Nickel Jam Nut Receptacle, solder board termination : **FWF TV 72N**

Square flange receptacle with Self Closing Cap (cap with a spring inside) :



- FWF 21N SCC (*)**
Nickel and metallized inserts (EMI) (*) This P/N includes the square flange receptacle and the self closing cap
- FWF 21B SCC (*)**
Black and blank insert

Note : Panel gasket to use with this version only : **JE18**

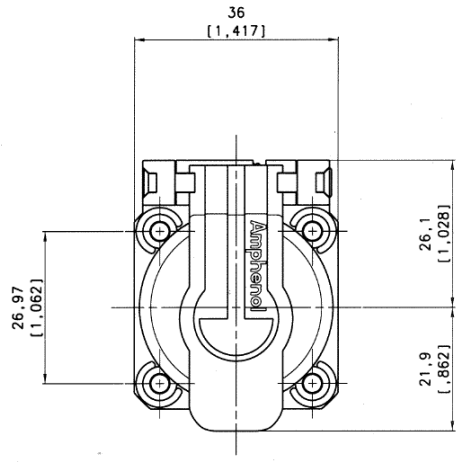
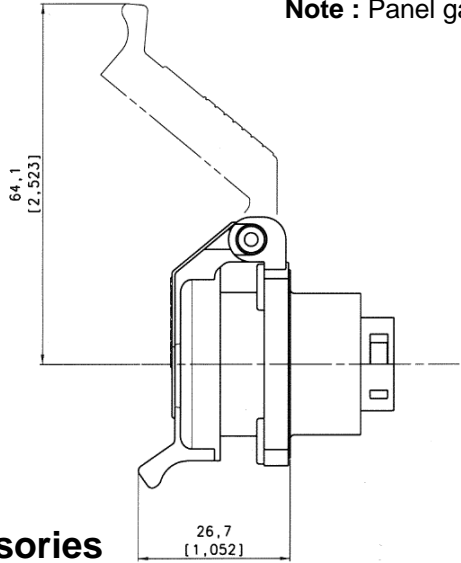

Accessories

- Metallic Caps

| | | | |
|------------------------------|---------|---|---|
| Connector Type | FWF TVC | 2 | G |
| 6 : Plug | | | |
| 2 : Square Flange Receptacle | | | |
| 7 : Jam Nut Receptacle | | | |
| Shell plating | | | |
| N : Nickel | | | |
| G : Olive Drab Cadmium | | | |

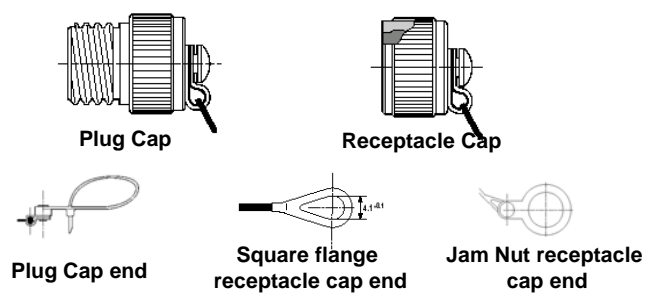

- Panel Gasket for square flange receptacle (Thickness : 0,8 mm [.031]) : **JE15**
- Receptacle Insert removal tool : **FWF ODE**



X-ON Electronics

Largest Supplier of Electrical and Electronic Components

Click to view similar products for [IEEE 1394 Connectors](#) category:

Click to view products by [Amphenol](#) manufacturer:

Other Similar products are found below :

[EHFF2](#) [PX0485/BK](#) [EHFF2B](#) [EHFWX2BX](#) [53460-0619](#) [3E106-0220KV](#) [1734290-2](#) [53460-0629](#) [53462-0629](#) [NA1394-6-W](#) [5788516-1](#)
[3E306-3200-008](#) [FWF21NSCC](#) [FWFODE](#) [FWFTV22G](#) [FWFTVC2G](#) [FWFTVC2N](#) [JE14](#) [JE18](#) [PX0480/BK](#) [928](#) [929](#) [930](#) [NA1394-6-W-B](#)
[EHFW800X2](#) [5787956-1](#) [PX0419](#) [PX0847](#) [693-006-699-003](#) [45740-0001](#) [53460-0639](#) [53462-0001](#) [53984-0681](#) [EHFW800X2B](#)
[EHFW800X2PKG](#) [1734290-1](#)