

REV	ECN	APP'D
-	3750	JEC 5/3/99
A	3893	JEC 1/6/00
B	3677	
C	6031	PJC 3-06-07
D	6138	PJC 10-22-07
E	6188	PJC 2-26-08

## FXP SERIES PART NUMBERING SCHEME

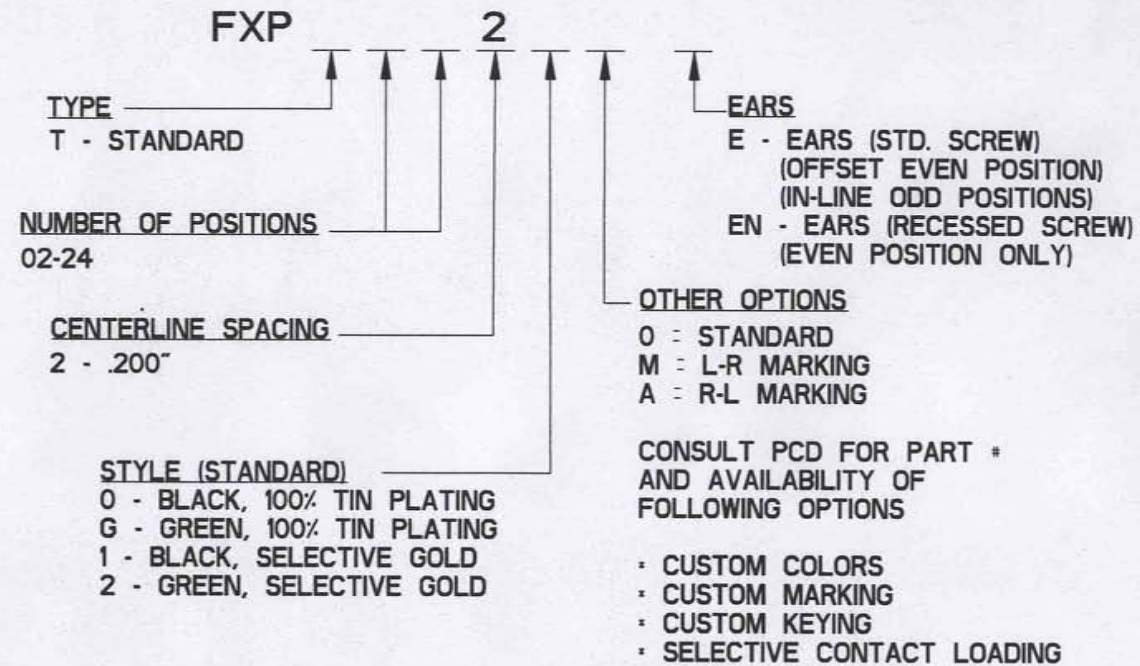

# POS	DIM "A"
2	.40
3	.60
4	.80
5	1.00
6	1.20
7	1.40
8	1.60
9	1.80
10	2.00
11	2.20
12	2.40
13	2.60
14	2.80
15	3.00
16	3.20
17	3.40
18	3.60
19	3.80
20	4.00
21	4.20
22	4.40
23	4.60
24	4.80

**UL**  
RATINGS

CURRENT - 15A  
VOLTAGE - 300V  
U.L. FILE NO. E83421

**SP**  
RATINGS

CURRENT - 15A  
VOLTAGE - 300V  
CSA FILE NO. LR69703

DIN VDE 0627:1986  
DIN VDE 0110-1:1989  
EN 60947-1:1991  
EN 60947-7-1:1992

CURRENT - PENDING  
VOLTAGE - PENDING  
TUV FILE NO. PENDING

**INSTALLATION RECOMMENDATIONS**  
WIRE RANGE: AWG #12-26, STRANDED  
WIRE STRIP LENGTH: .310"  
TIGHTENING TORQUE: 10 IN-LB

**MATERIALS:**  
HOUSING: PPO, UL 94 V-0  
CONTACT: COPPER ALLOY  
SCREW: STEEL, NICKEL FINISH

**MAX OPERATING TEMPERATURE:**  
105°C

<b>DIMENSIONS</b> ANSI Y14.5M UNITS: INCHES Pro/E FILE	<b>TOLERANCES</b> .XX ±0.02 .XXX ±0.010 ANGLES ±0.5°	<b>PROJECTION</b> 	<b>AMPHENOL PCD</b> SPECIFICATION DRAWING  ENGR D. MANTER 03-May-99		<b>TITLE</b>  <div style="font-size: 1.5em; font-weight: bold;">FXP SERIES PLUG ASSEMBLY</div>		
			CHKD A. PATRIE 03-May-99  APPD J. CAHALY 03-May-99				
ORIGINAL      THIS DOCUMENT CONTAINS PROPRIETARY INFORMATION WHICH IS THE CONFIDENTIAL PROPERTY OF AMPHENOL PCD PEABODY, MA, USA					CODE: 58982	SCALE: NONE	SHEET 1 OF 3

**EVEN CONFIG  
W/O EARS**

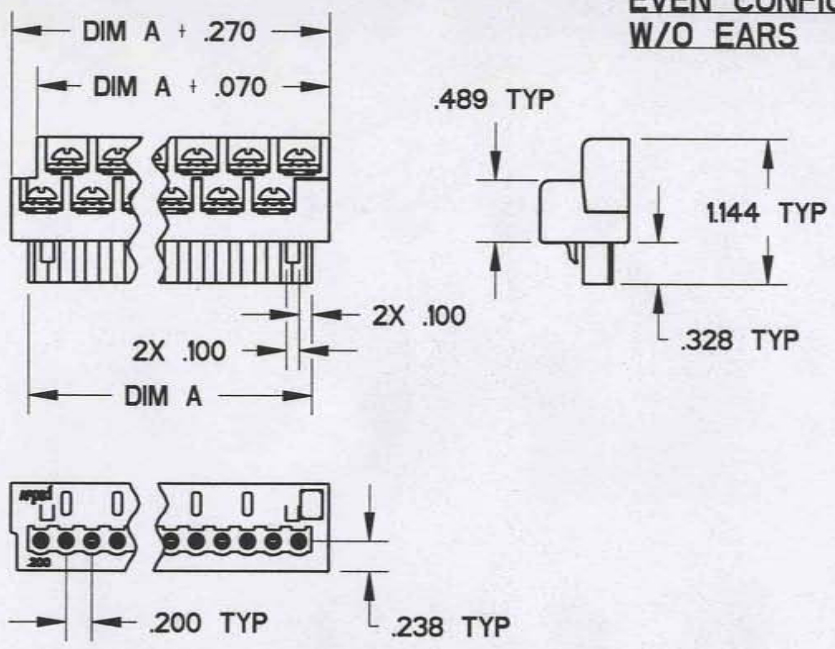

**EVEN CONFIG W/  
OFFSET EARS**

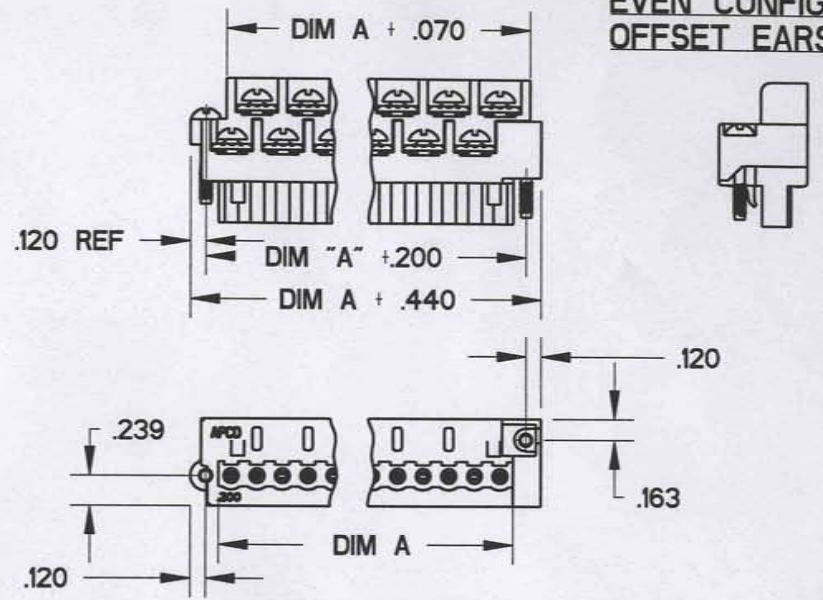

**ODD CONFIG  
W/O EARS**

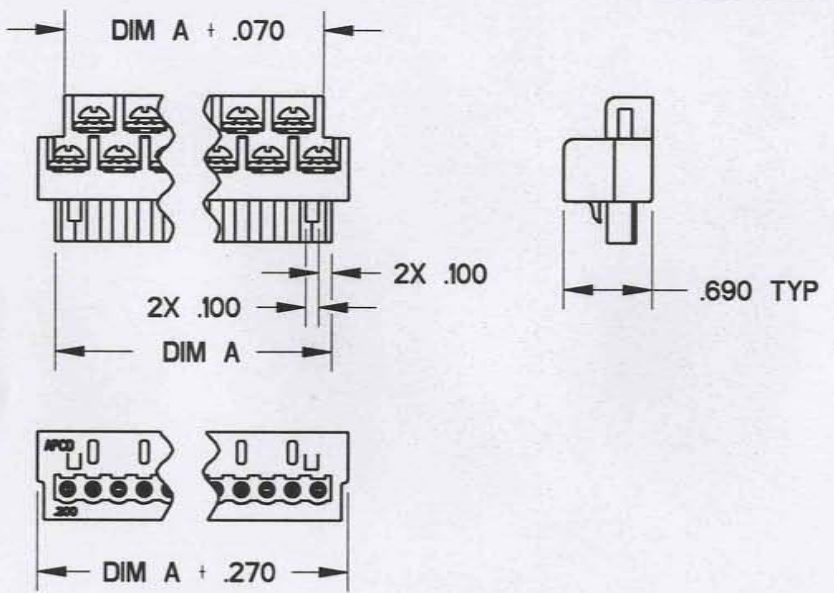

**ODD CONFIG W/  
INLINE EARS**

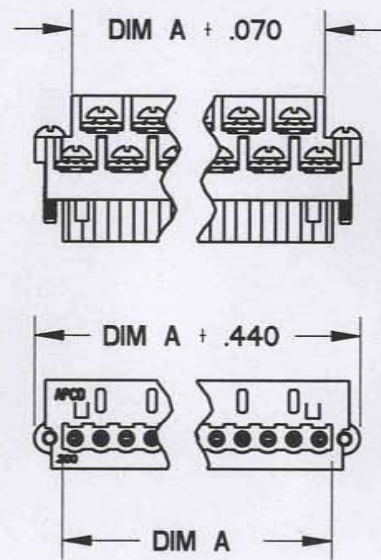

DIM A = NUM OF POS X CL SPACING

SIZE	DWG NO.	REV
<b>A</b>	<b>FXPTXX200</b>	<b>E</b>
CODE: 58982	SCALE: NONE	SHEET 2 OF 3

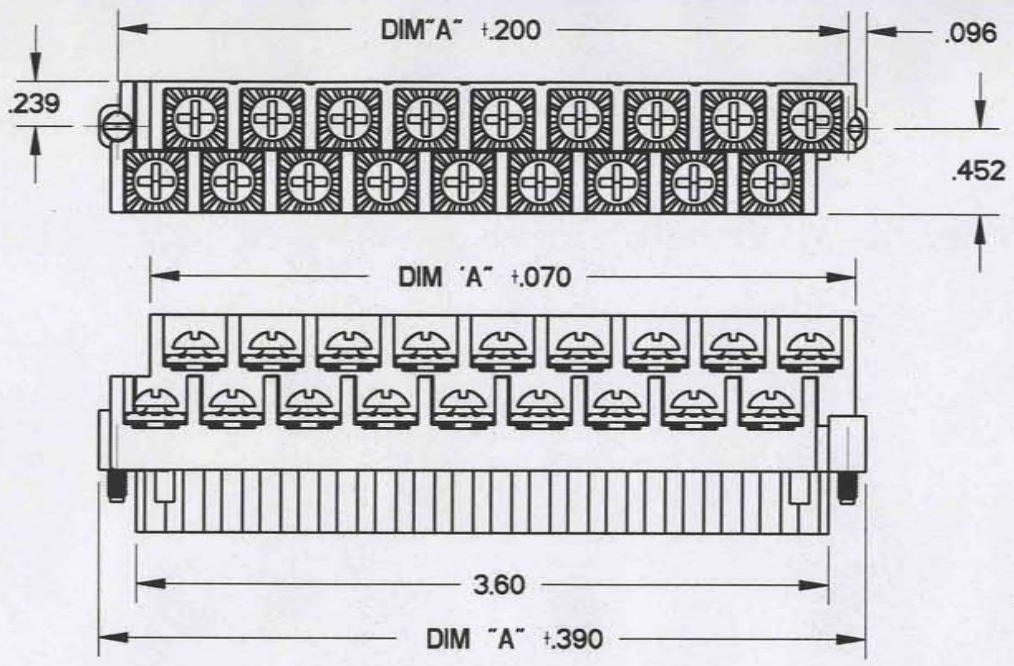

**EVEN CONFIG W/ IN-LINE EARS  
& RECESSED MOUNTING SCREW**

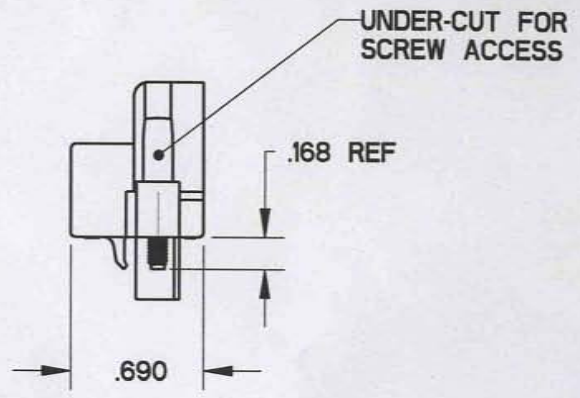

SIZE	DWG NO.	REV
A	FXPTXX200	E
CODE: 58982	SCALE: NONE	SHEET 3 OF 3

## X-ON Electronics

Largest Supplier of Electrical and Electronic Components

*Click to view similar products for [Barrier Terminal Blocks](#) category:*

*Click to view products by [Amphenol](#) manufacturer:*

Other Similar products are found below :

[CR151D20104](#) [670A-RZ-15-KT20](#) [6C1N03](#) [6PCR-02](#) [6PCR-02-008](#) [6PCR-05-008](#) [6PCR-08-008](#) [6PCR-09-008](#) [6PCR-13-006](#) [6PCR-15-006](#) [6PCR-21-006](#) [6PCV-06-008](#) [6PCV-09-001](#) [6PCV-10-009](#) [6PCV-15-008](#) [6PCV-20-323](#) [6PCV-30-006](#) [6STR-06-006](#) [6STR-08-006](#) [6STR-12-008](#) [6STR-13-006](#) [6STR-14-008](#) [6STR-16-008](#) [6STR-17-008](#) [6STR-21-008](#) [6STR-25-008](#) [6STR-27-008](#) [6STV-03-006](#) [6STV-03-008](#) [6STV-04-006](#) [6STV-09-006](#) [6STV-10-006](#) [6WWV-12-008](#) [72212603](#) [72504-C-50](#) [72506-C](#) [72507-C-50](#) [73203](#) [75505-C](#) [75505-C-50](#) [75510-C](#) [77010-50](#) [7C1N08](#) [812-GP-3/4ST-09](#) [8-1437402-5](#) [8PCR-06-006](#) [8PCR-11-006](#) [8PCV-02-008](#) [8PCV-04-001](#) [8PCV-04-008](#)