

This document is the property of Amphenol Corporation and is delivered on the express condition that is not to be disclosed, reproduced or used, in whole or in part, for manufacture or sale by anyone other than Amphenol Corporation without its prior consent, and that no right is granted to disclose or to use any information in this document.

The marking on this product doesn't contain environmental hazardous materials per Material Specification SS-00259 for Sony GP compliant or per directive 2011/65/EU for RoHS compliant or per IEC 61249-2-21 for Halogen-Free compliant.

REVISIONS				
SYM	ECN No.	DESCRIPTION	DATE	BY
A	NE-17089	RELEASE TO PRODUCTION	2017.04.26	Sondra Sang
B	NE-17318	ADDED PACKING OPTIONS IN PNS	2017.12.18	Sondra Sang

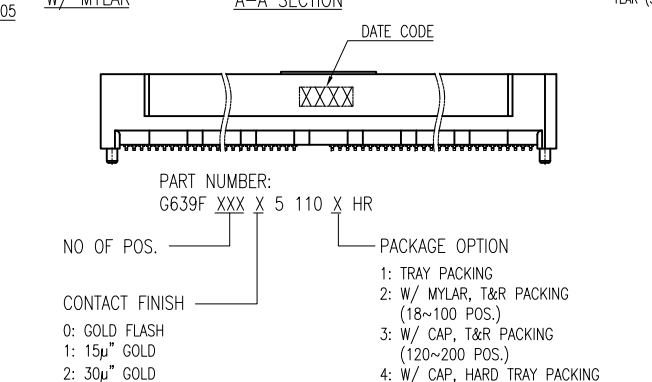
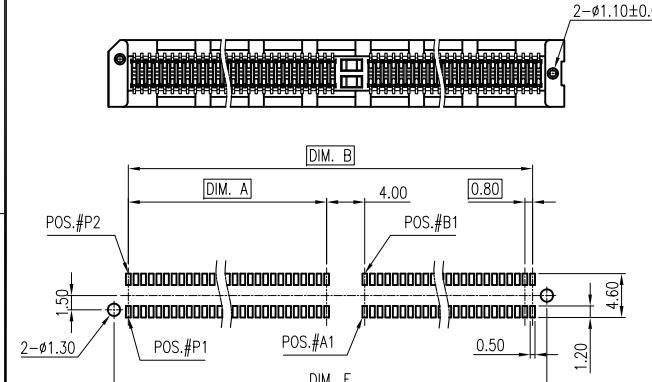
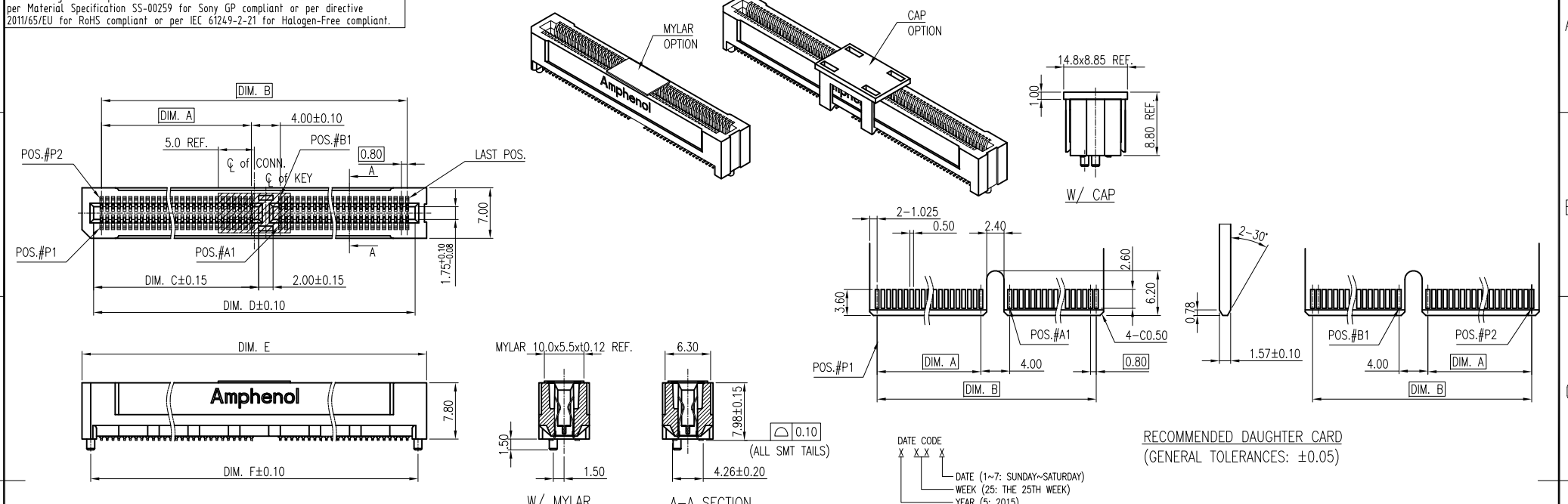

- NOTES:  
(GENERAL TOLERANCES: ±0.05)
- HOUSING: HIGH TEMPERATURE THERMOPLASTIC, UL 94V-0, COLOR- BLACK
  - CONTACT: COPPER ALLOY, SELECTIVE GOLD PLATED ON CONTACT AREA, 100μm MIN. MATTE TIN PLATED ON SOLDERING TAIL, 50μm MIN. NICKEL UNDER-PLATED OVERALL
  - PACKING DRAWING REFER TO PKS-G639FP001HR & PKS-G639FP003HR & PKS-G639F200P004HR & PKS-G639F200P005HR
  - THIS PRODUCT DOESN'T CONTAIN ENVIRONMENTAL HAZARDOUS MATERIALS PER R DIRECTIVE 2011/65/EC FOR RoHS AND PER IEC 61249-2-21 FOR HALOGEN FREE COMPLIANT.

POS.	DIM. A	DIM. B	DIM. C	DIM. D	DIM. E	DIM. F
200	24.80	82.40	26.90	84.60	87.80	85.40
180	24.80	74.40	26.90	76.60	79.80	77.40
160	24.80	66.40	26.90	68.60	71.80	69.40
140	24.80	58.40	26.90	60.60	63.80	61.40
120	24.80	50.40	26.90	52.60	55.80	53.40
100	20.80	42.40	22.90	44.60	47.80	45.40
98	20.80	41.60	22.90	43.80	47.00	44.60
80	16.80	34.40	18.90	36.60	39.80	37.40
74	16.00	32.00	18.10	34.20	37.40	35.00
64	13.60	28.00	15.70	30.20	33.40	34.00
50	4.00	22.40	6.10	24.60	27.80	25.40
26	4.00	12.80	6.10	15.00	18.20	15.80
18	2.40	9.60	4.50	11.80	15.00	12.60

TOLERANCE	DRAWN	APPROVALS	DATE	TITLE	UNIT	SIZE	PART No.
X	DESIGNED			CARDEDGE SUPER ST. CONN. HIGH SPEED, VERTICAL SMT	m m	A3	G639F XXX X 511 0X HR
X.X ±0.30	CHECKED						
X.XX ±0.20	APPROVED						
X.XXX ±0.10	DWG TYPE	CUST DWG	PROJECT CODE				
ANGULAR ±2°					SCALE	1 OF 2	DWG No.
UNLESS OTHERWISE SPECIFIED			T561		NA		G639FXXX5110XHR

**Amphenol®**  
Amphenol Corporation  
Amphenol Taiwan Corporation

This document is the property of Amphenol Corporation and is delivered on the express condition that is not to be disclosed, reproduced or used, in whole or in part, for manufacture or sale by anyone other than Amphenol Corporation without its prior consent, and that no right is granted to disclose or to use any information in this document.

The marking on this product doesn't contain environmental hazardous materials per Material Specification SS-00259 for Sony GP compliant or per directive 2011/65/EU for RoHS compliant or per IEC 61249-2-21 for Halogen-Free compliant.

REVISIONS				
SYM	ECN No.	DESCRIPTION	DATE	BY
A	NE-17089	RELEASE TO PRODUCTION	2017.04.26	Sondra Sang
B	NE-17318	ADDED PACKING OPTIONS IN PNS	2017.12.18	Sondra Sang

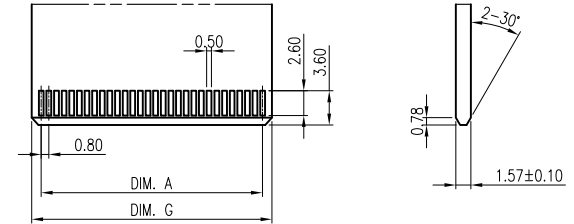
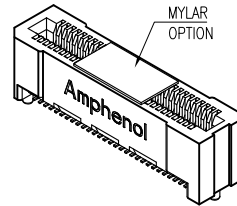
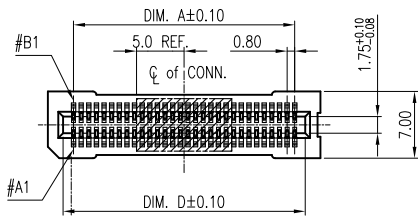

RECOMMENDED DAUGHTER CARD  
(GENERAL TOLERANCES: ±0.05)

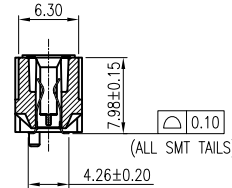
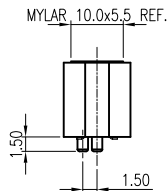
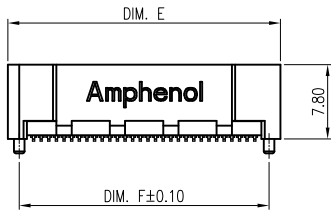

A-A SECTION

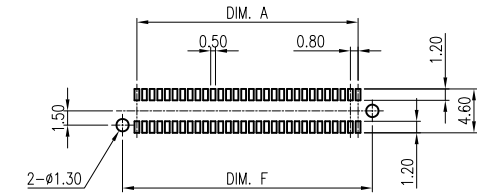
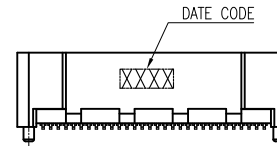

RECOMMENDED PCB LAYOUT - TOP VIEW  
(GENERAL TOLERANCES: ±0.05)



PART NUMBER:  
G639F XXX X 5 110 X HR

NO OF POS.

PACKAGE OPTION

- 1: TRAY PACKING
- 2: W/ MYLAR, T&R PACKING
- 6: W/O MYLAR, T&R PACKING

CONTACT FINISH

- 0: GOLD FLASH
- 1: 15µ" GOLD
- 2: 30µ" GOLD

DATE CODE  
X X X X  
DATE (1~7: SUNDAY~SATURDAY)  
WEEK (25: THE 25TH WEEK)  
YEAR (5: 2015)

POS.	DIM. A	DIM. D	DIM. E	DIM. F	DIM. G
68	26.40	28.60	31.80	29.40	28.40
60	23.20	25.40	28.60	26.20	25.20
40	15.20	17.40	20.60	18.20	17.20
34	12.80	15.00	18.20	15.80	14.80
20	7.20	9.40	12.60	10.20	9.20

NOTES:

1. HOUSING: HIGH TEMPERATURE THERMOPLASTIC, UL 94V-0, COLOR- BLACK
2. CONTACT: COPPER ALLOY, SELECTIVE GOLD PLATED ON CONTACT AREA, 100µ" MIN. MATTE TIN OVER 50µ" MIN. NICKEL UNDER-PLATED OVERALL 50µ" MIN. NICKEL UNDER-PLATED OVERALL
3. PACKING DRAWING REFER TO PKS-G639FP001HR & PKS-G639FP003HR
4. THIS PRODUCT DOESN'T CONTAIN ENVIRONMENTAL HAZARDOUS MATERIALS PER R DIRECTIVE 2011/65/EC FOR RoHS AND PER IEC 61249-2-21 FOR HALOGEN FREE COMPLIANT.

TOLERANCE	DRAWN	APPROVALS	DATE	TITLE	UNIT	SIZE	PART No.
X. X.X X.XX X.XXX	DESIGNED			CARDEDGE SUPER ST. CONN. HIGH SPEED, VERTICAL SMT	m m	A3	G639F XXX X 511 0X HR
ANGULAR ±2°	CHECKED				SCALE	SHEET	DWG No.
UNLESS OTHERWISE SPECIFIED	APPROVED				NA	1 OF 2	G639FXXXX5110XHR
	DWG TYPE	CUST DWG	PROJECT CODE	T561			REV. B

**Amphenol®**

Amphenol Corporation  
Amphenol Taiwan Corporation

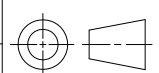

UNIT: m m, SIZE: A3, SHEET: 1 OF 2, REV: B

## X-ON Electronics

Largest Supplier of Electrical and Electronic Components

*Click to view similar products for [Standard Card Edge Connectors](#) category:*

*Click to view products by [Amphenol](#) manufacturer:*

Other Similar products are found below :

[CR7E-30DB-3.96E\(72\)](#) [6565204-6](#) [PKC-156](#) [1437274-4](#) [147889-1](#) [1489165-4](#) [EBT15622B2X](#) [1-582587-1](#) [284-0102-12100](#)  
[306022901000000](#) [307-012-502-202](#) [307-056-520-300](#) [245-062-520-350](#) [287-0032-12101](#) [306-028-525-102](#) [307-072-526-202](#) [345-060-559-](#)  
[303](#) [392-008-559-201](#) [534671-1](#) [341-240-317](#) [345-044-500-300](#) [346-240-318](#) [395-100-524-300](#) [09-07-2032](#) [10035388-802LF](#) [10122859-](#)  
[009LF](#) [10127905-B04B24BLF](#) [530555-1](#) [5-678046-1](#) [73726-0005](#) [66308-1](#) [1-1437275-6](#) [PEC-07-02-T-S-A](#) [346-014-520-801](#) [307-048-502-](#)  
[202](#) [CE100F22-9-C](#) [CE100F26-7-C](#) [CE100F28-3-D](#) [CE156F18-9-C](#) [CE156F22-5-D](#) [CE156F22-9-C](#) [CT100F22-2-D](#) [CT100F22-3-D](#)  
[CT100F24-2-D](#) [CT100F24-3-D](#) [CT100F24-6-C](#) [CT156F22-4-D](#) [MLSS100-12-C](#) [MLSS100-16-C](#) [SCC100F-11-C](#)