

RR-HR

D-Sub connectors - Stamped and Formed Contacts

REAR RELEASE CRIMP CONNECTORS

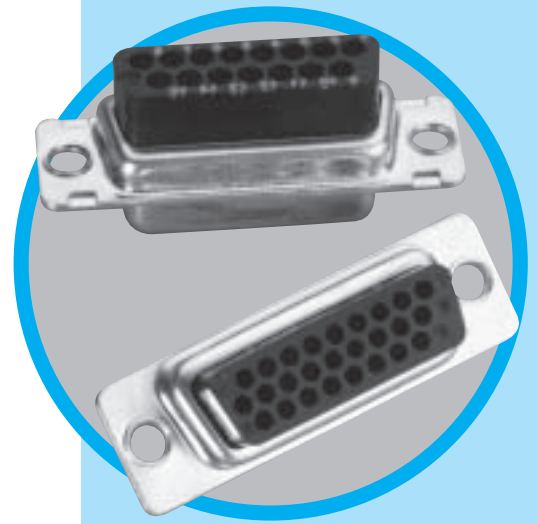

Specifications

- Connectors according to MIL C24308

| Materials and Platings | | |
|----------------------------|---|-------------------|
| Shells | Tinned steel with or without dimples on plug connector | |
| Insulator Boardlock | Black glass-filled thermoplastic, UL 94V-0 | |
| Screwlock | Brass, 3µm to 5µm (118µ" to 197µ") tin over nickel 2µm to 3µm (78µ" to 118µ") | |
| | Brass, 6µm to 10µm (236µ" to 394µ") tin over nickel 2µm to 3µm (78µ" to 118µ") | |
| Contacts-Brass | Under plating | Crimp side |
| 0.2µm (8µ") gold | 2µm (78µ") nickel | gold flash or tin |
| 0.5µm (20µ") gold | 2µm (78µ") nickel | gold flash or tin |
| 0.76µm (30µ") gold | 2µm (78µ") nickel | gold flash or tin |

| Electrical Data | |
|------------------------------|--|
| Current rating | 5A |
| Voltage rating | 500V AC/rms 50Hz |
| Withstanding voltage | RR: 1000V AC/rms 50Hz for 1 minute HR: 1000V AC/rms 60Hz for 1 minute |
| Insulation resistance | RR: 5000MΩ HR: 1000MΩ |
| Contact resistance | 10mΩ max |
| Wire size | 20-28 AWG max insulation Ø1.27mm (.05") |

| Climatic Data | |
|------------------------------|-----------------|
| Operating temperature | -55°C to +125°C |

| Mechanical Data | | | | | |
|---------------------------|-------------|---------------|---------------|--------------|-------------|
| Mating and unmating force | | | | | |
| Unit: kg (lb) | | | | | |
| No. of Cts | | Mate (max) | | Unmate (min) | |
| RR | HR | RR | HR | RR | HR |
| 9 (size E) | 15 (size E) | 3.05 (6.74) | 3.81 (8.42) | 0.36 (0.79) | 0.52 (1.14) |
| 15 (size A) | 26 (size A) | 5.09 (11.24) | 5.95 (13.16) | 0.46 (1.01) | 1.05 (2.32) |
| 25 (size B) | 44 (size B) | 8.44 (18.66) | 9.26 (20.46) | 0.81 (1.8) | 1.37 (3.02) |
| 37 (size C) | 62 (size C) | 12.51 (27.65) | 13.48 (29.78) | 1.1 (2.47) | 1.76 (3.88) |
| 50 (size D) | 78 (size D) | 14.65 (32.38) | 15.82 (34.96) | 1.6 (3.56) | 2.02 (4.46) |

Designed for high volume production, Amphenol's rear release crimp connector and contacts provide significant cost saving.

- EMI / RFI shell configuration.
- Removable, reusable contacts.
- Automatic and manual tooling available.

Simplify your cable assemblies

- Commercial
- Industrial
- Telecom
- Any industry standard I / O connections



Amphenol

CHARACTERISTICS

DESCRIPTION

APPLICATIONS

RR-HR / E11

Standard density RR

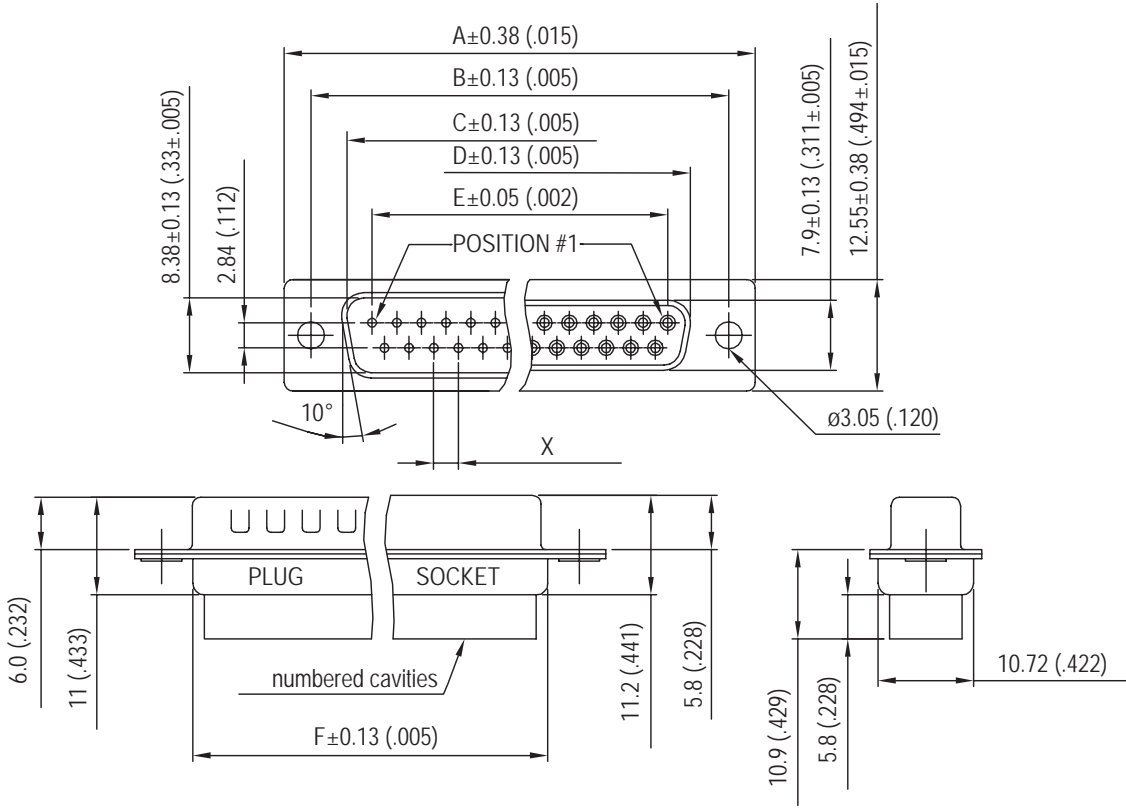

| Nb OF CONTACTS | DIMENSIONS mm (inch) | | | | | | |
|----------------|----------------------|--------------|--------------|--------------|--------------|--------------|------|
| | A | B | C | D | E | F | X |
| 9 | 30.84 (1.21) | 24.99 (.98) | 16.92 (.67) | 16.24 (.64) | 11.09 (.44) | 19.28 (.76) | 2.77 |
| 15 | 39.24 (1.54) | 33.32 (1.31) | 24.7 (.972) | 24.56 (.97) | 19.39 (.76) | 27.51 (1.08) | 2.77 |
| 25 | 53.04 (2.09) | 47.04 (1.85) | 38.96 (1.53) | 38.38 (1.51) | 33.24 (1.31) | 41.30 (1.63) | 2.77 |
| 37 | 69.32 (2.73) | 63.50 (2.50) | 55.42 (2.18) | 54.76 (2.16) | 49.86 (1.96) | 57.71 (2.27) | 2.77 |
| 50 | 67 (2.64) | 61.11 (2.41) | 52.86 (2.08) | 52.34 (2.06) | 44.32 (1.75) | 55.3 (2.18) | 2.77 |

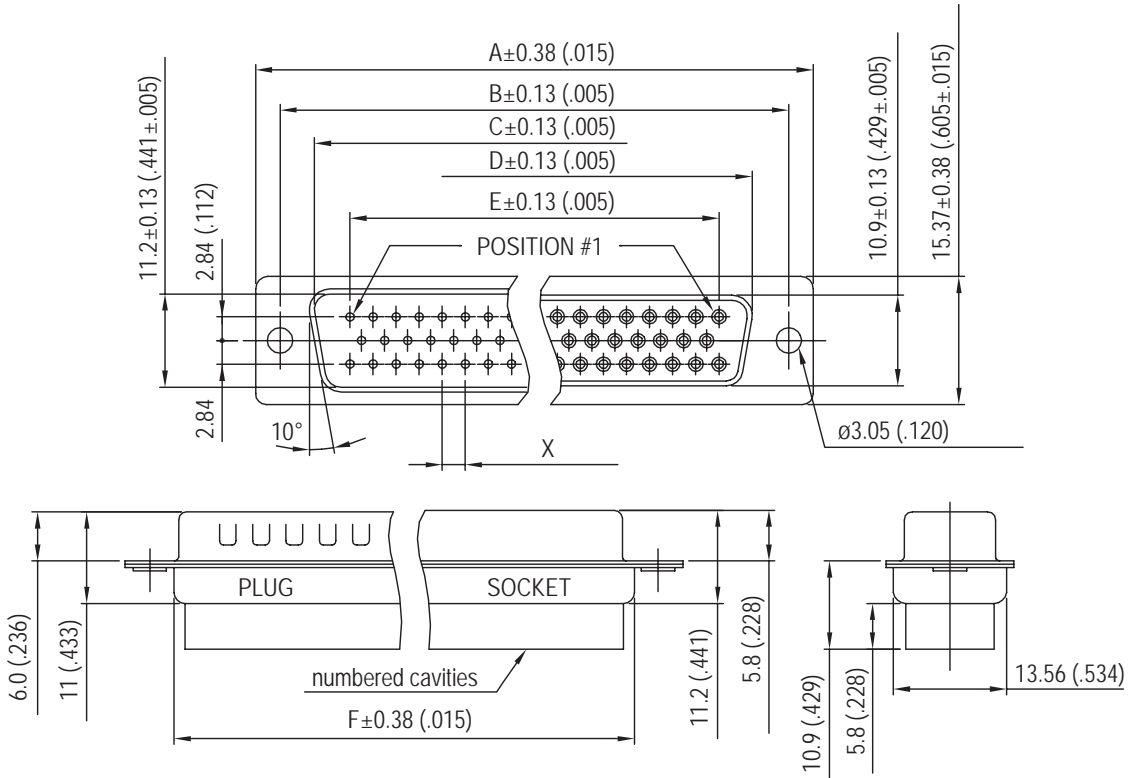

High density HR

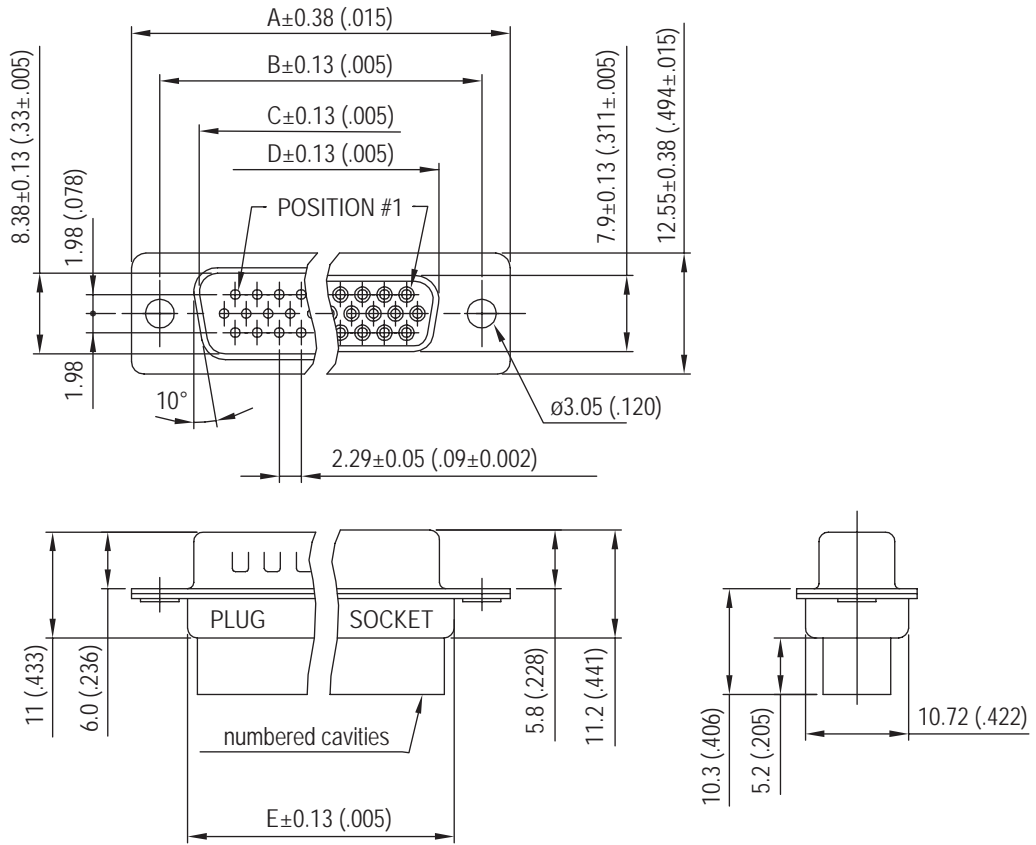

| Nb OF CONTACTS | DIMENSIONS mm (inch) | | | | |
|----------------|----------------------|--------------|--------------|--------------|--------------|
| | A | B | C | D | E |
| 15 | 30.84 (1.21) | 24.99 (.98) | 16.92 (.67) | 16.24 (.64) | 19.28 (.76) |
| 26 | 39.24 (1.54) | 33.32 (1.31) | 24.7 (.972) | 24.56 (.97) | 27.51 (1.08) |
| 44 | 53.04 (2.09) | 47.04 (1.85) | 38.96 (1.53) | 38.38 (1.51) | 41.30 (1.63) |
| 62 | 69.32 (2.73) | 63.50 (2.50) | 55.42 (2.18) | 54.76 (2.16) | 57.71 (2.27) |
| 78 | 67 (2.64) | 61.11 (2.41) | 52.86 (2.08) | 52.34 (2.06) | 55.3 (2.18) |

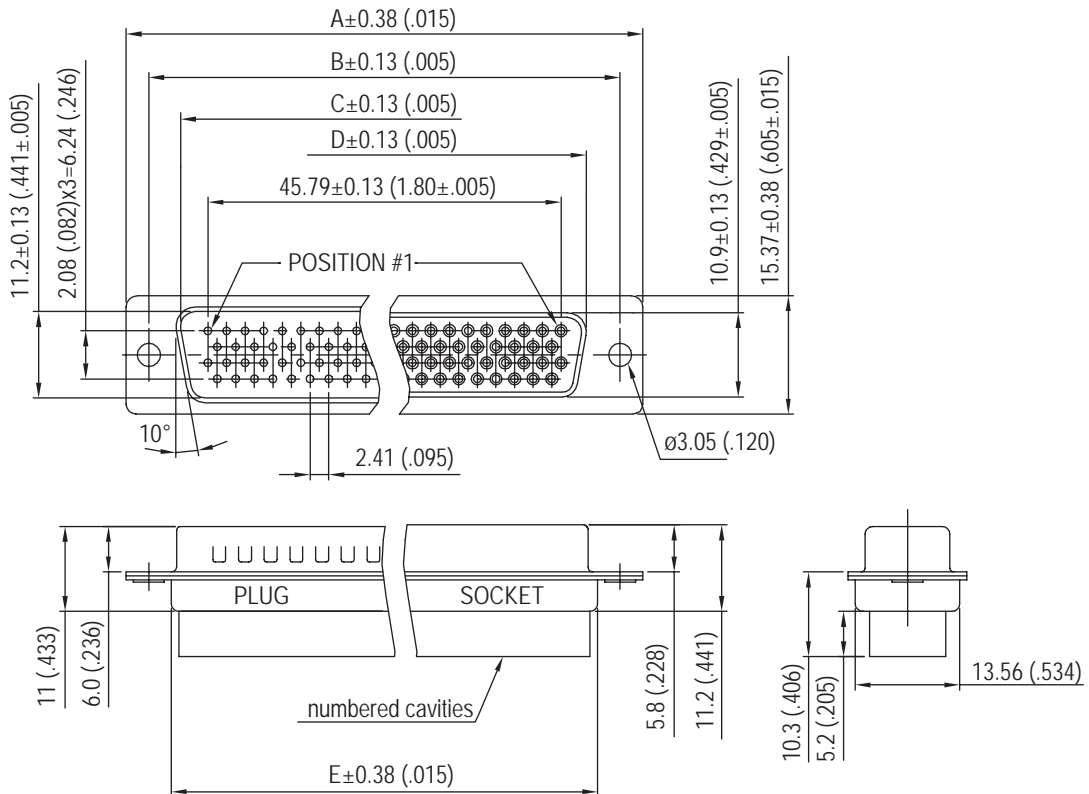

Panel mounting option

Standard density:

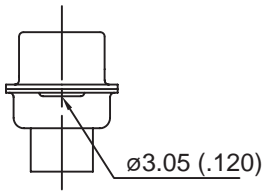

Standard rivet \varnothing 3.05mm
no digit

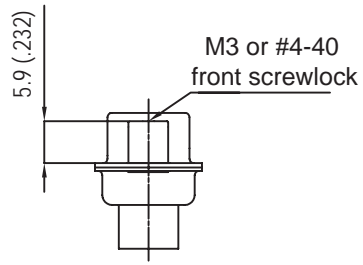

Fixed front female screwlock
VF / VFM

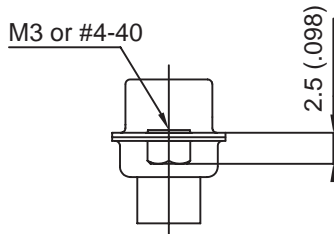

Threaded rear insert
H / G

High density:

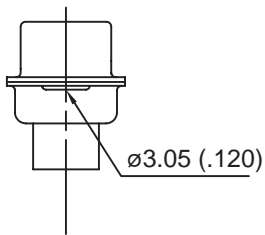

Standard rivet \varnothing 3.05mm
no digit

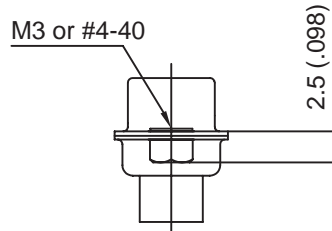

Threaded rear insert
H / G

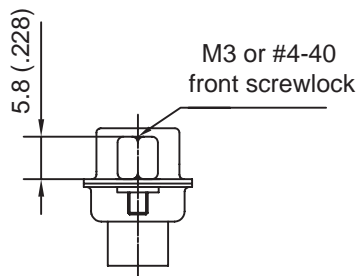

Fixed front female screwlock
VF / VFM

Contacts

Standard density:

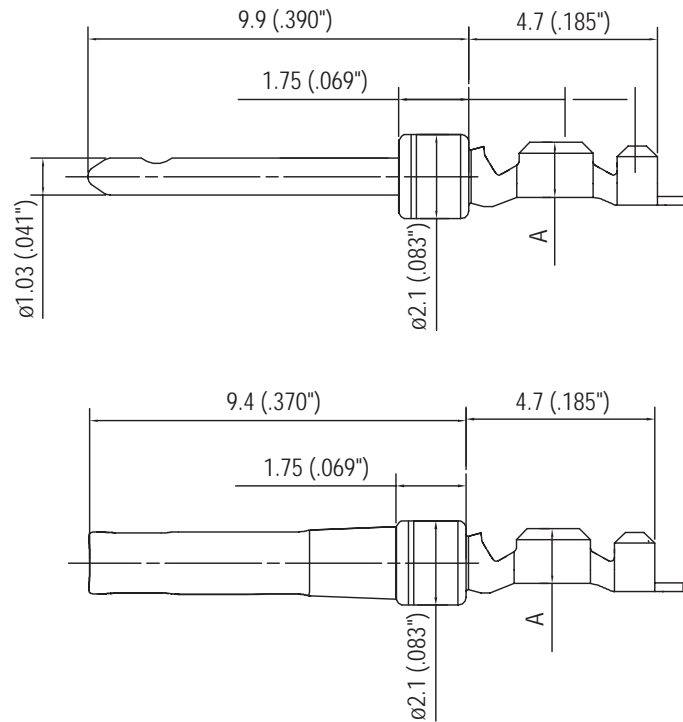
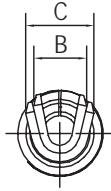

| AWG | A | B | C |
|-------|-------------|-------------|-------------|
| 20-24 | 1.8 (.071") | 1.9 (.075") | 2.5 (.098") |
| 24-28 | 1.4 (.055") | 1.5 (.059") | 1.7 (.066") |

High density:

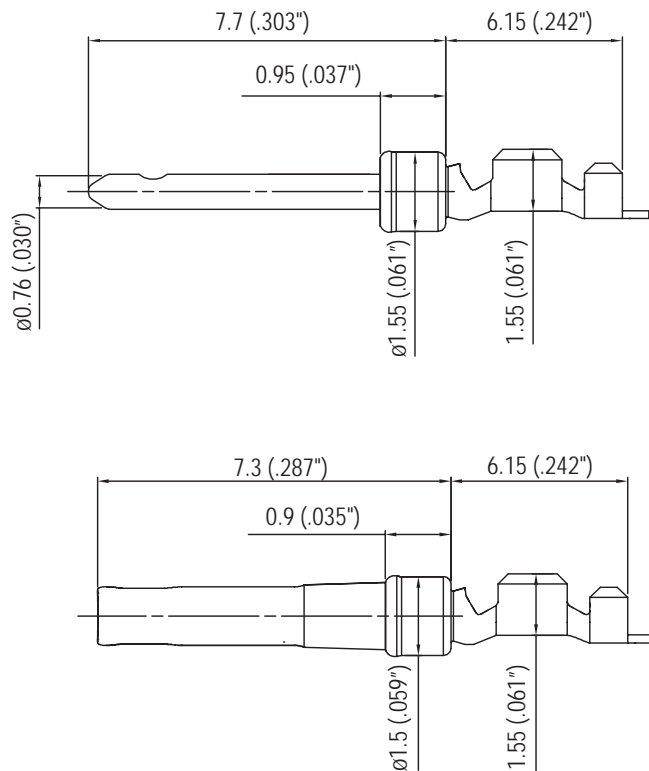
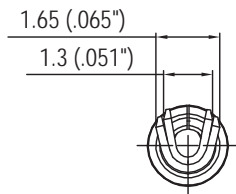

How to order HR (high density)

Housings

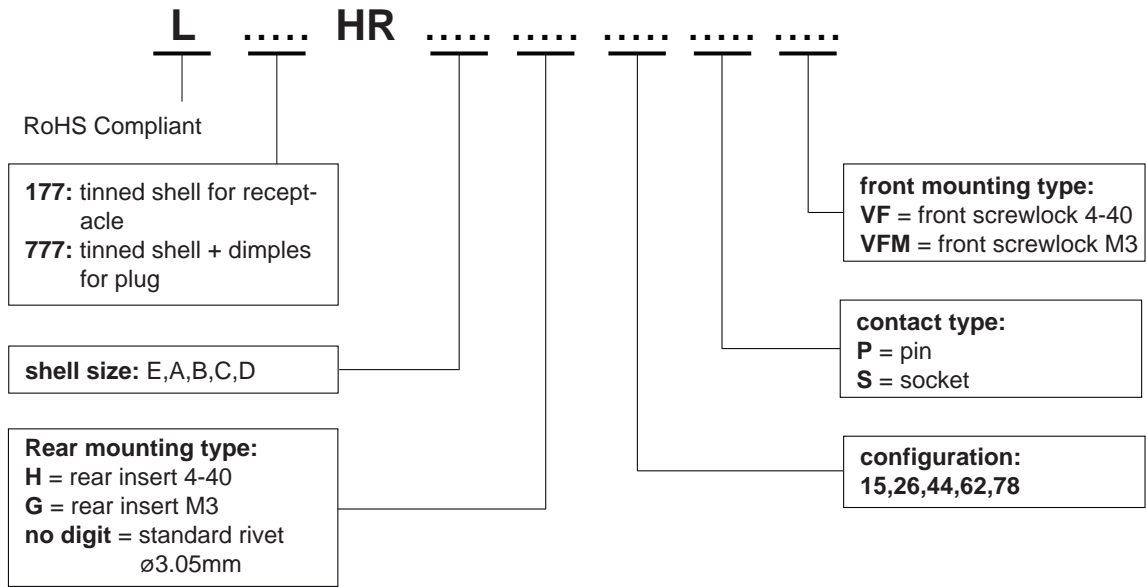

Contacts

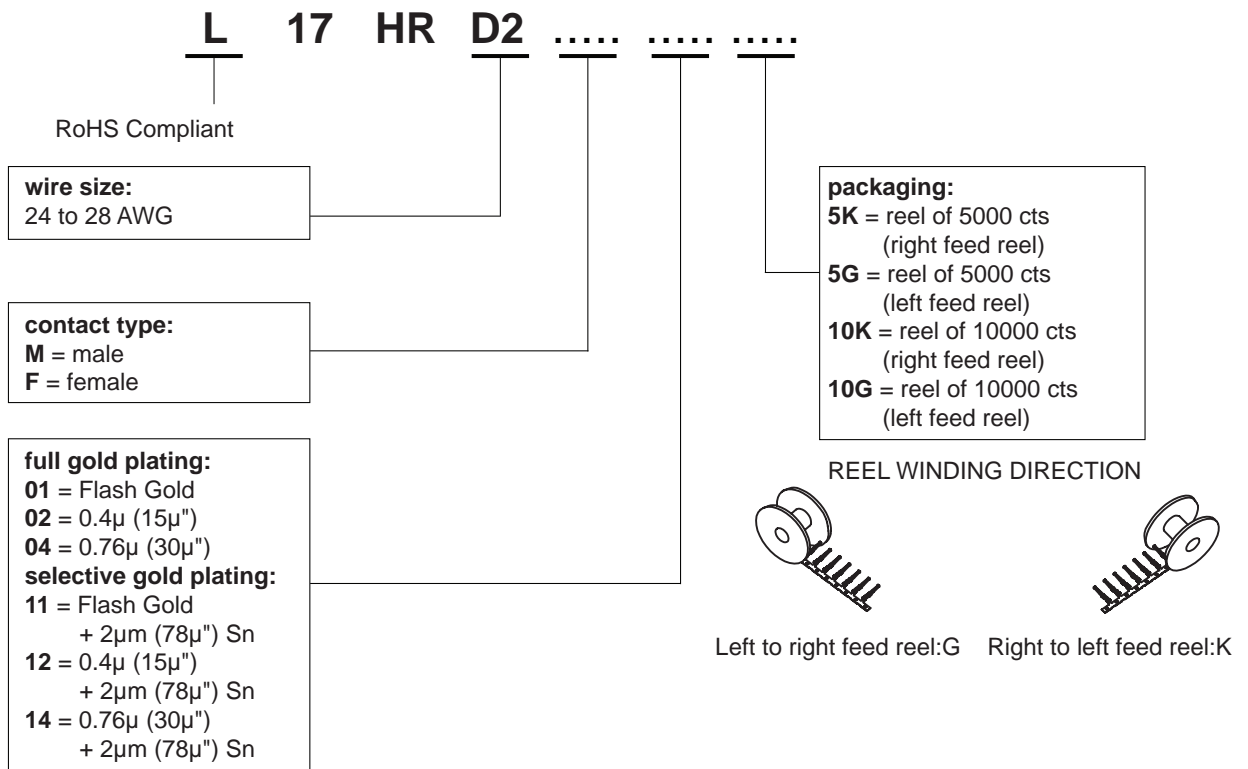

For special request, please consult factory

Tooling for crimp contacts

For standard density crimp contacts: 17RR series

- | | |
|---|-------------|
| • contact insertion and removal tool | 17D 438 SP |
| • hand crimp tool for single contacts AWG 20 to 28 | 17D 440 SP |
| • hand crimp tool for reels of 400 contacts | FA 0000 762 |
| crimp dies: AWG 20 to 24 | FA 0000 104 |
| crimp dies: AWG 24 to 28 | FA 0000 102 |
| • stripping box | FE 0400 |
| • automatic crimp machine for reels of 2000 to 10000 contacts | 970 MC |
| crimp dies: AWG 20 to 24 | 968 MC |
| crimp dies: AWG 24 to 28 | 972 MC |

For high density crimp contacts: 17HR series

- | | |
|---|--------|
| • automatic crimp machine for reels of 2000 to 10000 contacts | 970 MC |
| crimp dies: AWG 24 to 28 | 973 MC |

Do not hesitate to contact us for further information



Amphenol

Amphenol IT & Communication Products

Block A3/A4, The 4th Industrial District of
Industrial Headquarters, Dong Keng Road
Gong Ming Town, Shen Zhen China
Fax: +86(0)755 2754 9955

Technical Support

Tel: +86(0)755 2717 7945
Info-dsub@amphenol.com.cn
<http://www.dsubconnector.com>

X-ON Electronics

Largest Supplier of Electrical and Electronic Components

Click to view similar products for [D-Sub Standard Connectors](#) category:

Click to view products by [Amphenol](#) manufacturer:

Other Similar products are found below :

[56F706-005-LI](#) [56F711-015](#) [012-9507-004](#) [LV242999-142T12](#) [015-0341-000](#) [015-0372-005](#) [015-0372-008](#) [015-8755-001](#) [020419-0104](#)
[012-0467-000](#) [012-9507-034](#) [012-9507-114](#) [020745-0008](#) [609-25P](#) [CT2-18-11PCAU](#) [CT6-10SL-3SC](#) [CT6-10SL-4SC](#) [CT6-14S-2SC](#)
[CT6E14SA7SC](#) [CT6N10SL-4SSA34](#) [M83513/01-FC](#) [M83723/76W24619 L/C](#) [M85049/48-3-2F](#) [6STD09PCM99B70X](#) [6STD09SCM99B30X](#)
[6STD09SCT99S40X](#) [6STD15PCT99S40X](#) [6STD15SCT99S40X](#) [6STF09PCM05B70X](#) [7-135760-9](#) [MC11E-10-6SN](#) [747552-3](#) [MD1-21PS](#)
[MDM-15SCBRM7-F222](#) [MDM96517-699](#) [MDM96521-744](#) [MDVB1-21SL1](#) [MIK0-1-7SH003](#) [MIKQ6-7SH076](#) [MIKQ7-7PH077](#) [MIKQ7-](#)
[7PH11](#) [MIKQ7-7PH32](#) [MJSV-28SL61](#) [MKJ4A1F14-55S](#) [8-135760-3](#) [8STD09PCM99B30X](#) [PG-KV/PV-16-GROM-SEALING](#) [GDA15P](#)
[GDAY15PB](#) [980-0000-170](#)