

# Amphenol

*Now you're connected*

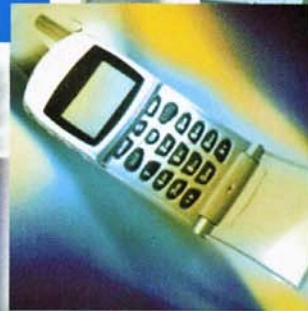

## D-Sub Hardware

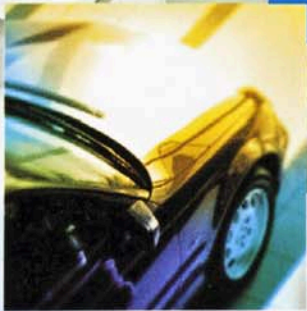

# D-SUBMINIATURE HARDWARE

## Female Screw Lock Assemblies

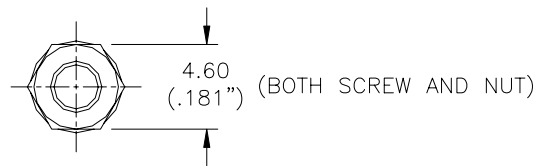
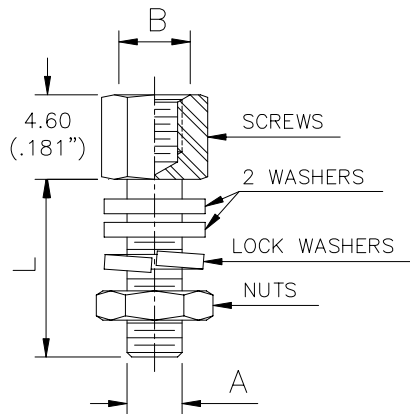

Screwlock/nut:  
Washer:  
Lock washer:

Steel, tin plated  
Steel, tin plated  
XC 35, tin plated

P/N	Quantity	Packaging	Plating	A	B	L
L17D20418 2 X	10 Screws	Bag	Tin	4-40	4-40	8.3mm (.327")
L17D20418 2M3 X	10 Screws	Bag	Tin	M3	4-40	8.3mm (.327")
L17D20418 33 X	10 Screws	Bag	Tin	M3	4-40	8.5mm (.335")
L17D20418 M3 X	10 Screws	Bag	Tin	M3	M3	8.3mm (.327")
L17D20418 2L X	10 Screws	Bag	Tin	4-40	4-40	13mm (.511")
L17D20418 2LM3 X	10 Screws	Bag	Tin	M3	4-40	13mm (.511")
L17D20418 2SM3 X	10 Screws	Bag	Tin	M3	4-40	15.8mm (.622")
L17D20418 39 X	10 Screws	Bag	Tin	4-40	4-40	15.8mm (.622")
L17D20418 2T X	10 Screws	Bag	Tin	4-40	4-40	8.3mm (.327")
L17D20418 43 X	10 Screws	Bag	Tin	M3	4-40	8.5mm (.311")

Screw lock assemblies are sold in bags of ten sets. 2 sets are required per connector

# D-SUBMINIATURE HARDWARE

Metal Dust Cover



Material: Steel  
Plating: Tin plated

Description	Shell Size	Number of Contacts		Cover for Socket Connector	Cover for Plug Connector
		Standard Density	High Density		
Metal Dust Cover, Without Chain	E	9	15	L17D 4K 63010	L17D 4K 63110
	A	15	26	L17D 4K 63016	L17D 4K 63116
	B	25	44	L17D 4K 63026	L17D 4K 63126
	C	37	62	L17D 4K 63038	L17D 4K 63138
	D	50	78	L17D 4K 63051	L17D 4K 63151
Metal Dust Cover, With Chain	E	9	15	L17D 4K 63009	L17D 4K 63109
	A	15	26	L17D 4K 63015	L17D 4K 63115
	B	25	44	L17D 4K 63025	L17D 4K 63125
	C	37	62	L17D 4K 63037	L17D 4K 63137
	D	50	78	L17D 4K 63050	L17D 4K 63150

# D-SUBMINIATURE HARDWARE

## Slide Lock Assemblies

Plate Material: Steel, tin plated  
 Mounting Screws: Steel, tin plated  
 (Bag contains 1 plate, 2 mounting screws, 2 nuts, 4 washers and 2 locking washers)

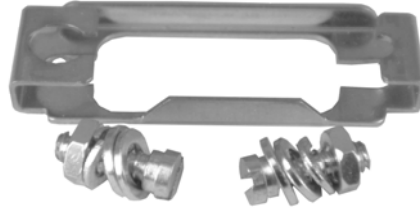

## Locking Post Assembly

P.N. L17D 53018 X (10/bag)

Post Screw: Steel, tin plated  
 (Bag contains 10 mounting screws, 10 nuts, 20 washers and 10 locking washers)

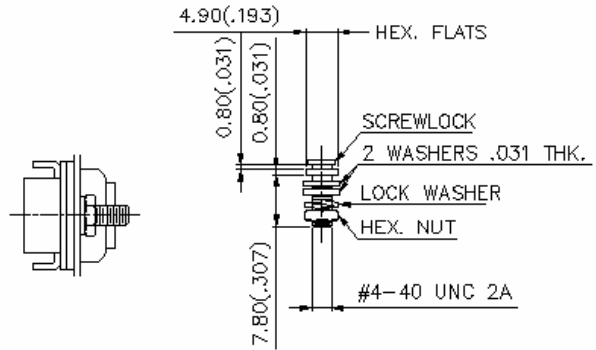
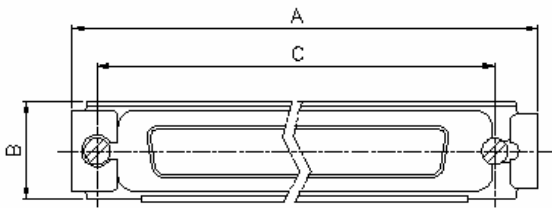

Slide lock and locking post assemblies sold separately

Shell Size	Part No.	A	B	C
E	L17D 51224 1	35mm (1.378")	12.6mm (.496")	27.4mm (1.079")
A	L17D 51220 1	43.3mm (1.705")	12.6mm (.496")	35.7mm (1.406")
B	L17D 51221 1	57.5mm (2.264")	12.6mm (.496")	49.47mm (1.948")
C	L17D 51222 1	74.2mm (2.921")	12.6mm (.496")	65.9mm (2.594")
D	L17D 51223 1	71.5mm (2.815")	15.1mm (.594")	63.5mm (2.500")

# D-SUBMINIATURE HARDWARE

## Male Screw Lock Assembly

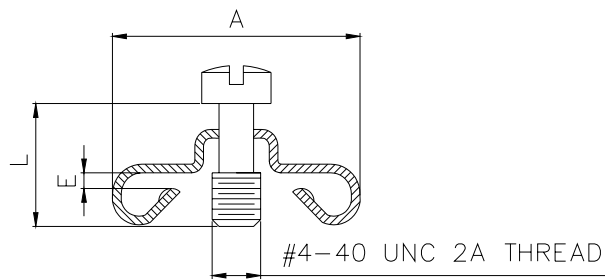

Material:



Steel, tin plated

Part No. E, A, B C Shell	A	L	E
L17D 20419 21 X	14.3mm (.563")	7.1mm (.280")	1.4mm (.055")
L17D 20419 18 X	14.3mm (.563")	7.1mm (.280")	1.0mm (.039")
L17D 20419 16 X	14.3mm (.563")	7.1mm (.280")	1.2mm (.047")
L17D 20419 X	14.3mm (.563")	7.1mm (.280")	0.8mm (.031")
D Shell			
L17D 20420 12 X	16.9mm (.665")	7.1mm (.280")	1.4mm (.055")
L17D 20420 13 X	16.9mm (.665")	7.1mm (.280")	1.0mm (.039")
L17D 20420 15 X	16.9mm (.665")	7.1mm (.280")	1.2mm (.047")
L17D 20420 X	16.9mm (.665")	7.1mm (.280")	0.8mm (.031")

## Spring Latch

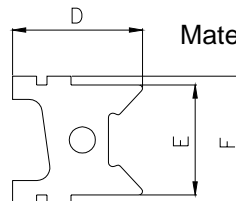
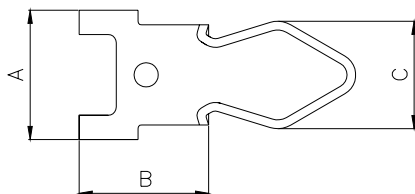

Material:

Steel, tin plated

Size	Part No.	A	B	C	D	E	F
E, A, B, C	L17 529	14.8mm (.583")	15.6mm (.614")	12.3mm (.484")	14.9mm (.587")	12.6mm (.496")	14.6mm (.575")



# Amphenol

connecting people  
in the new millenium



Amphenol Corporation is one of the world's leading producers of electronic and fiber optic connectors, cable and interconnect systems. The primary end markets for the Company's products are communication systems for the converging technologies of voice, video and data communications, including wired and wireless internet, broadband networks, industrial, automotive and aerospace applications.

With more than **55 manufacturing and assembly operations on 5 continents** and sales, marketing and distribution organizations in more than **55 countries**, Amphenol has developed a strategy of local operations which allow proximity to market and reactivity. This worldwide globalization allows permanent cost reduction programs and continuous investments to meet customer expectations, as well as engineering talents around the world to design for local needs.

Our company, characterized by speed and flexibility, provides and develops new solutions for infra-structure, enterprise networks, handset and internet appliances.

## Amphenol

### Amphenol IT & Communication Products

Amphenol Shenzhen Sales Office  
Shenzhen, China  
Tel: +86-755-8368-3575  
Fax: +86-755-8368-3567  
Email: [info@amphenol.com.cn](mailto:info@amphenol.com.cn)

Amphenol InfoCom Europe  
Houten, Netherlands  
Tel: +31-30-635-8000  
Fax: +31-30-637-7034  
Email: [info@amphenol-nl.com](mailto:info@amphenol-nl.com)

Amphenol East Asia Limited  
Hong Kong, China  
Tel: +852-2699-2663  
Fax: +852-2688-0974  
Email: [info@amphenol.com.hk](mailto:info@amphenol.com.hk)

Amphenol Canada Corp.  
Ontario, Canada  
Tel: +1-416-291-4401  
Fax: +1-416-292-0647  
Email: [sales@amphenolcanada.com](mailto:sales@amphenolcanada.com)

Amphenol China Sales Offices  
Beijing  
Tel: +86-10-6468-4019  
Fax: +86-10-6468-4020

Amphenol Dae Shin Limited  
Bucheon, Korea  
Tel: +82-32-610-3800  
Fax: +82-32-673-2507  
Email: [info@amphenol.co.kr](mailto:info@amphenol.co.kr)  
Web: [www.amphenol.co.kr](http://www.amphenol.co.kr)

Amphenol Taiwan Corporation  
Taoyuan, Taiwan  
Tel: +886-3-264-7200  
Fax: +886-3-327-5296  
Email: [info@amphenol.com.tw](mailto:info@amphenol.com.tw)

Amphenol South East Asia  
The Concourse, Singapore  
Tel: +65-6294-2128  
Fax: +65-6294-3522  
Email: [info@amphenol.com.sg](mailto:info@amphenol.com.sg)

Xi'an  
Tel/Fax: +86-29-8781-3718  
Email: [info@amphenol.com.cn](mailto:info@amphenol.com.cn)

Amphenol Shanghai Sales Office  
Shanghai China  
Tel: +86-21-6267-5566  
Fax: +86-21-6272-7587  
Email: [info@amphenol.com.cn](mailto:info@amphenol.com.cn)

Amphenol Commercial Products, Americas  
Milpitas, CA, USA  
Tel: +1-408-546-0397  
Fax: +1-408-546-0399  
Email: [info@amphenolacp.com](mailto:info@amphenolacp.com)

Do not hesitate to contact us for further information



Factory Address:  
Block A3/A4, The 4th Industrial District of  
Industrial Headquarters, Dong Keng Road  
Gong Ming Town, Shen Zhen China  
Fax: +86(0)755 2754 9955

Technical Support  
Tel: +86(0)755 2717 7945  
[Info-dsub@amphenol.com.cn](mailto:Info-dsub@amphenol.com.cn)  
[www.dsubconnector.com](http://www.dsubconnector.com)

## X-ON Electronics

Largest Supplier of Electrical and Electronic Components

*Click to view similar products for [D-Sub Tools & Hardware](#) category:*

*Click to view products by [Amphenol](#) manufacturer:*

Other Similar products are found below :

[173112-0667](#) [173112-0759](#) [173112-0967](#) [173112-0291](#) [173112-0456](#) [000-01-09-132](#) [000-01-21-132](#) [000-01-31-162](#) [572019-00105-70](#)  
[000-01-37-162](#) [621-250-113-115](#) [D20418-2R](#) [D20418-J3F](#) [70521CLF](#) [70524BLF](#) [70527BLF](#) [70527CLF](#) [F1042-1PLAH](#) [750643-1](#) [780-010-06G4-00C](#) [780-518-50SG6-WS](#) [863004ATLF](#) [86552009](#) [86553115TLF](#) [86553117TLF](#) [86553156LF](#) [FSGK1/5](#) [980-8554-000](#) [980-8555-000](#)  
[980-8557-000](#) [980-8558-000](#) [1230032-1](#) [1-5021101-2](#) [15-000050](#) [1589283-4](#) [160-000-005R031](#) [16-000230](#) [160-020-109R000](#) [160-025-004R031](#) [160-015-003R031](#) [160-020-209R000](#) [160X10909X](#) [164C03939A](#) [177-505-A-2-2](#) [177-505-C-4-4](#) [179-013-1H](#) [1-966830-8](#) [21018-6](#)  
[21028-3](#) [213622-5](#)