

RR-HR

D-Sub connectors - Stamped and Formed Contacts

REAR RELEASE CRIMP CONNECTORS

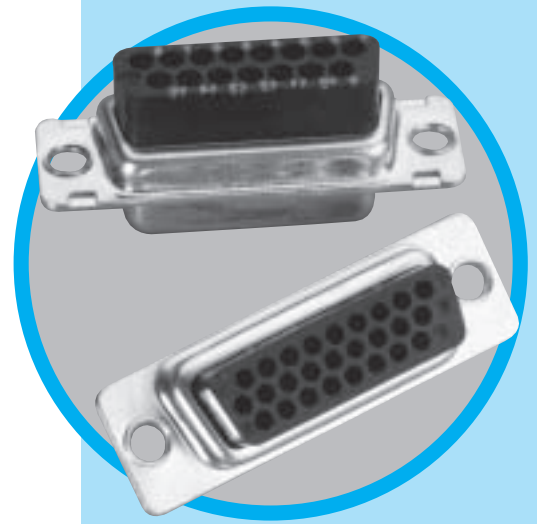

Specifications

- Connectors according to MIL C24308

Materials and Platings		
Shells	Tinned steel with or without dimples on plug connector	
Insulator Boardlock	Black glass-filled thermoplastic, UL 94V-0	
Screwlock	Brass, 3µm to 5µm (118µ" to 197µ") tin over nickel 2µm to 3µm (78µ" to 118µ")	
	Brass, 6µm to 10µm (236µ" to 394µ") tin over nickel 2µm to 3µm (78µ" to 118µ")	
Contacts-Brass	Under plating	Crimp side
0.2µm (8µ") gold	2µm (78µ") nickel	gold flash or tin
0.5µm (20µ") gold	2µm (78µ") nickel	gold flash or tin
0.76µm (30µ") gold	2µm (78µ") nickel	gold flash or tin

Electrical Data	
Current rating	5A
Voltage rating	500V AC/rms 50Hz
Withstanding voltage	RR: 1000V AC/rms 50Hz for 1 minute HR: 1000V AC/rms 60Hz for 1 minute
Insulation resistance	RR: 5000MΩ HR: 1000MΩ
Contact resistance	10mΩ max
Wire size	20-28 AWG max insulation Ø1.27mm (.05")

Climatic Data	
Operating temperature	-55°C to +125°C

Mechanical Data					
Mating and unmating force					
Unit: kg (lb)					
No. of Cts		Mate (max)		Unmate (min)	
RR	HR	RR	HR	RR	HR
9 (size E)	15 (size E)	3.05 (6.74)	3.81 (8.42)	0.36 (0.79)	0.52 (1.14)
15 (size A)	26 (size A)	5.09 (11.24)	5.95 (13.16)	0.46 (1.01)	1.05 (2.32)
25 (size B)	44 (size B)	8.44 (18.66)	9.26 (20.46)	0.81 (1.8)	1.37 (3.02)
37 (size C)	62 (size C)	12.51 (27.65)	13.48 (29.78)	1.1 (2.47)	1.76 (3.88)
50 (size D)	78 (size D)	14.65 (32.38)	15.82 (34.96)	1.6 (3.56)	2.02 (4.46)

Designed for high volume production, Amphenol's rear release crimp connector and contacts provide significant cost saving.

- EMI / RFI shell configuration.
- Removable, reusable contacts.
- Automatic and manual tooling available.

Simplify your cable assemblies

- Commercial
- Industrial
- Telecom
- Any industry standard I / O connections



Amphenol

CHARACTERISTICS

DESCRIPTION

APPLICATIONS

RR-HR / E11

Standard density RR

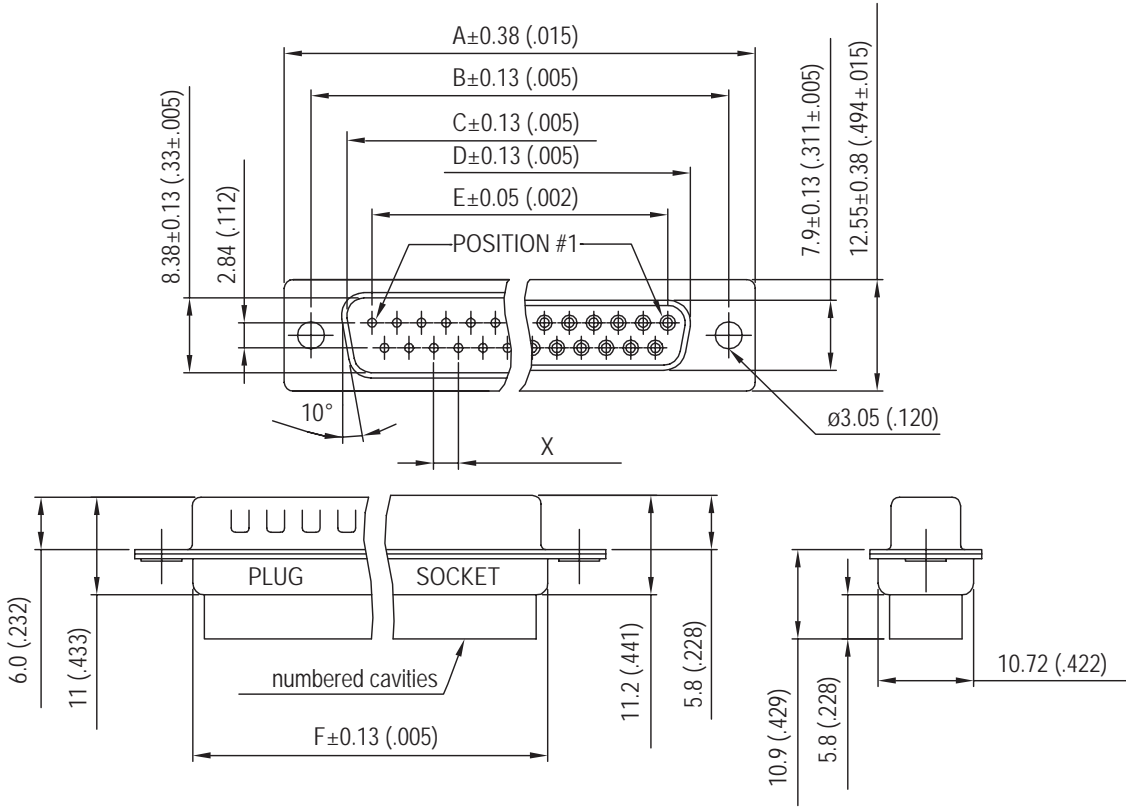

Nb OF CONTACTS	DIMENSIONS mm (inch)						
	A	B	C	D	E	F	X
9	30.84 (1.21)	24.99 (.98)	16.92 (.67)	16.24 (.64)	11.09 (.44)	19.28 (.76)	2.77
15	39.24 (1.54)	33.32 (1.31)	24.7 (.972)	24.56 (.97)	19.39 (.76)	27.51 (1.08)	2.77
25	53.04 (2.09)	47.04 (1.85)	38.96 (1.53)	38.38 (1.51)	33.24 (1.31)	41.30 (1.63)	2.77
37	69.32 (2.73)	63.50 (2.50)	55.42 (2.18)	54.76 (2.16)	49.86 (1.96)	57.71 (2.27)	2.77
50	67 (2.64)	61.11 (2.41)	52.86 (2.08)	52.34 (2.06)	44.32 (1.75)	55.3 (2.18)	2.77

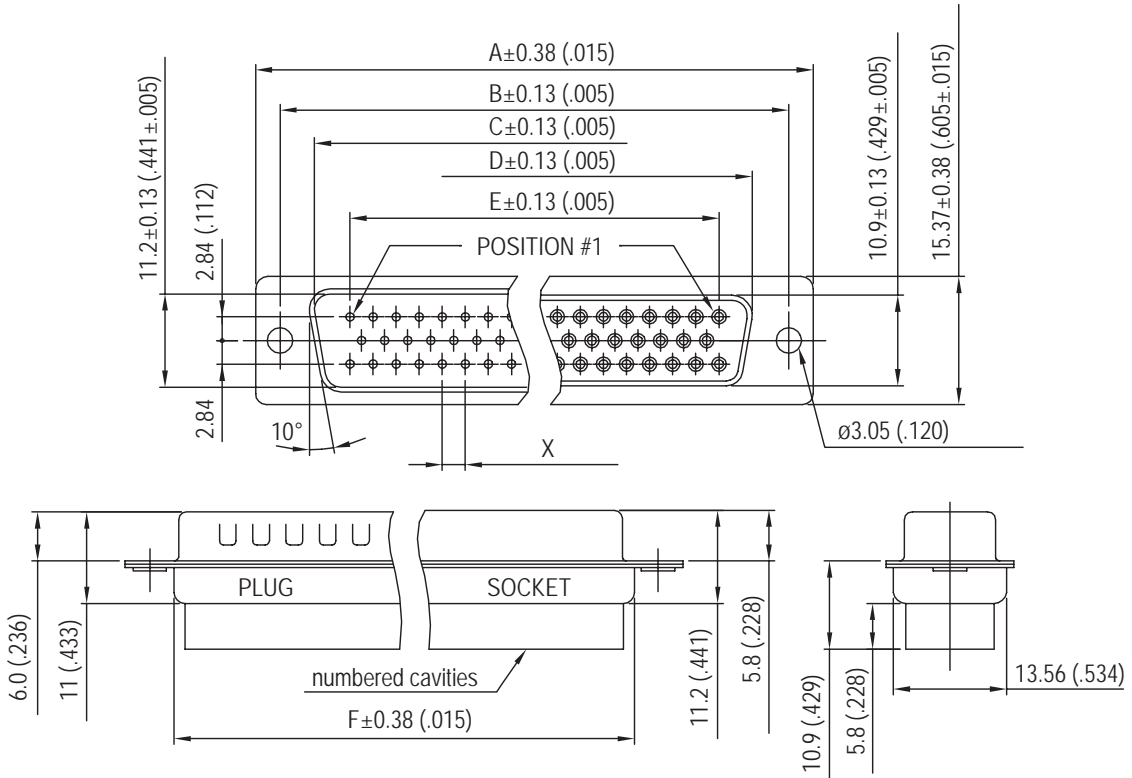

High density HR

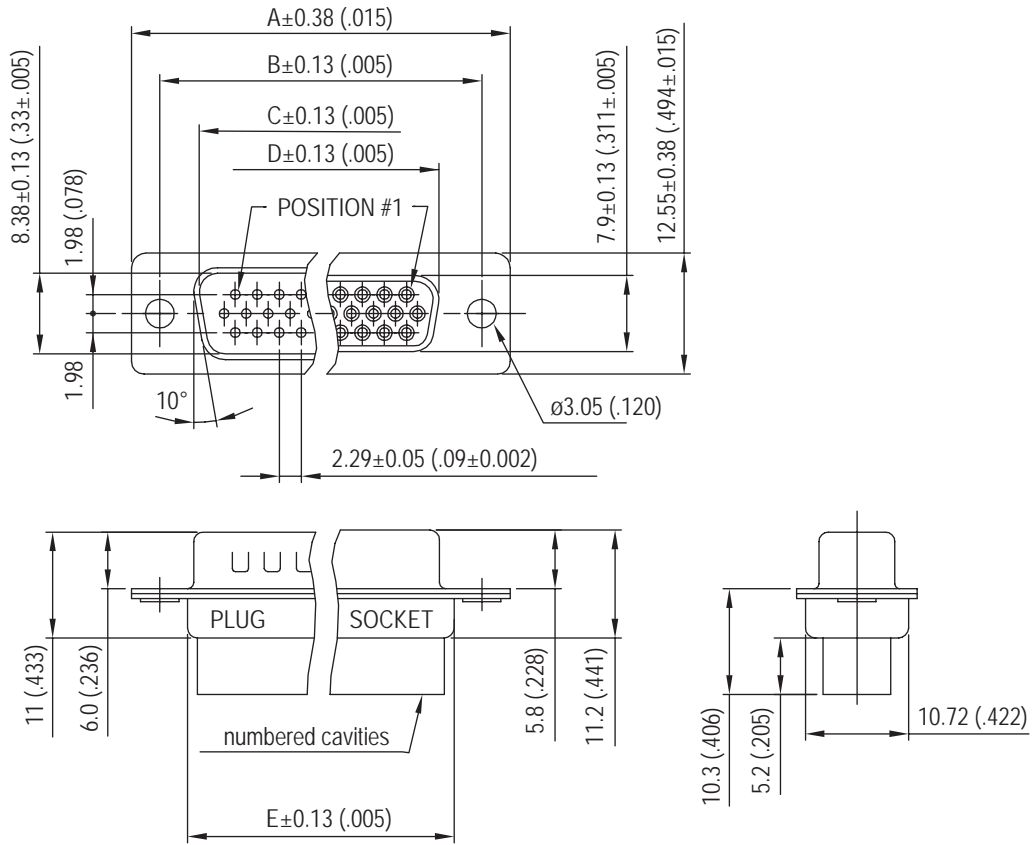

Nb OF CONTACTS	DIMENSIONS mm (inch)				
	A	B	C	D	E
15	30.84 (1.21)	24.99 (.98)	16.92 (.67)	16.24 (.64)	19.28 (.76)
26	39.24 (1.54)	33.32 (1.31)	24.7 (.972)	24.56 (.97)	27.51 (1.08)
44	53.04 (2.09)	47.04 (1.85)	38.96 (1.53)	38.38 (1.51)	41.30 (1.63)
62	69.32 (2.73)	63.50 (2.50)	55.42 (2.18)	54.76 (2.16)	57.71 (2.27)
78	67 (2.64)	61.11 (2.41)	52.86 (2.08)	52.34 (2.06)	55.3 (2.18)

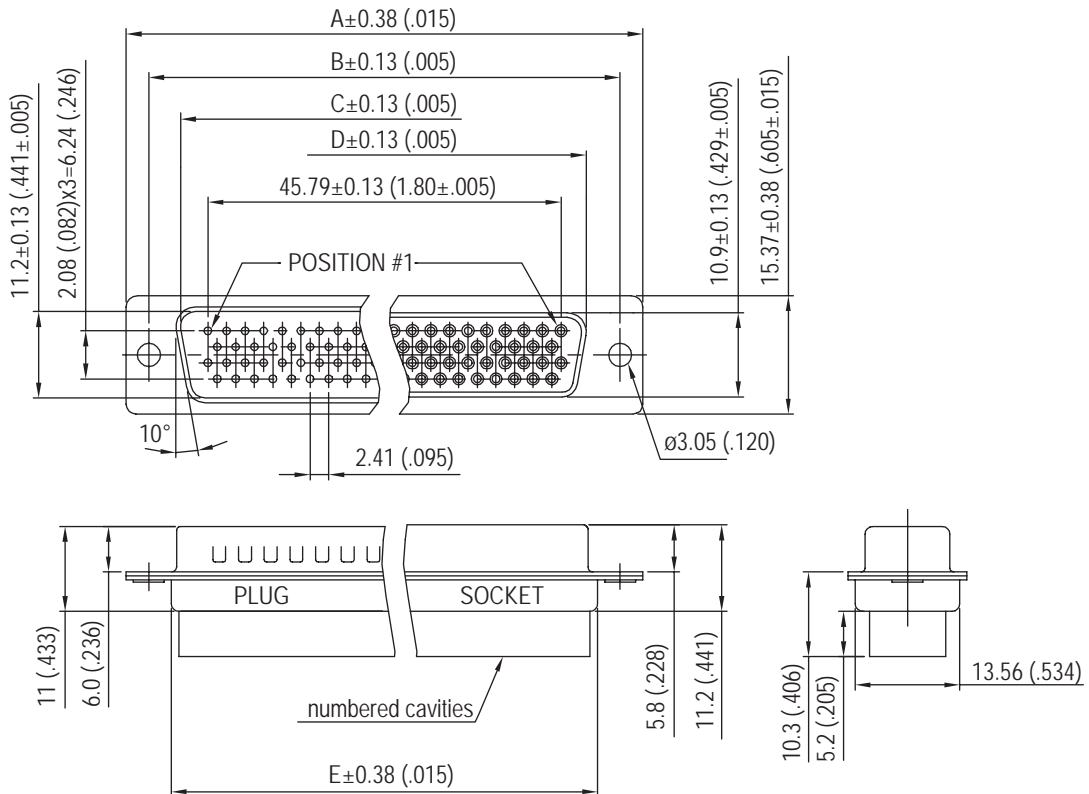

Panel mounting option

Standard density:

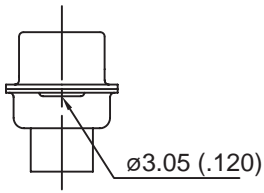

Standard rivet \varnothing 3.05mm
no digit

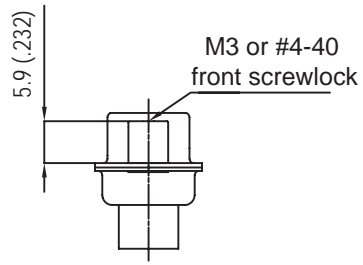

Fixed front female screwlock
VF / VFM

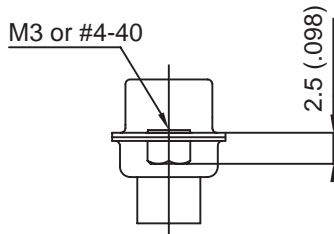

Threaded rear insert
H / G

High density:

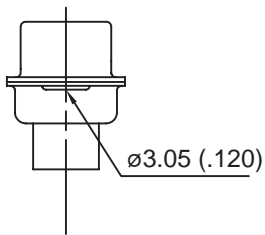

Standard rivet \varnothing 3.05mm
no digit

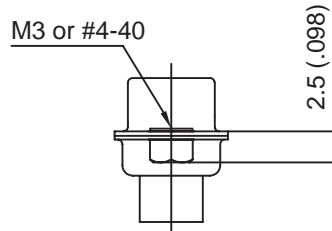

Threaded rear insert
H / G

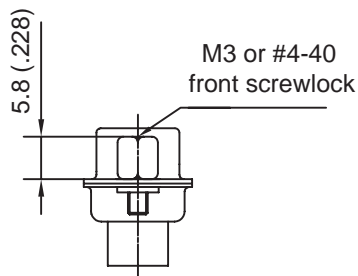

Fixed front female screwlock
VF / VFM

Contacts

Standard density:

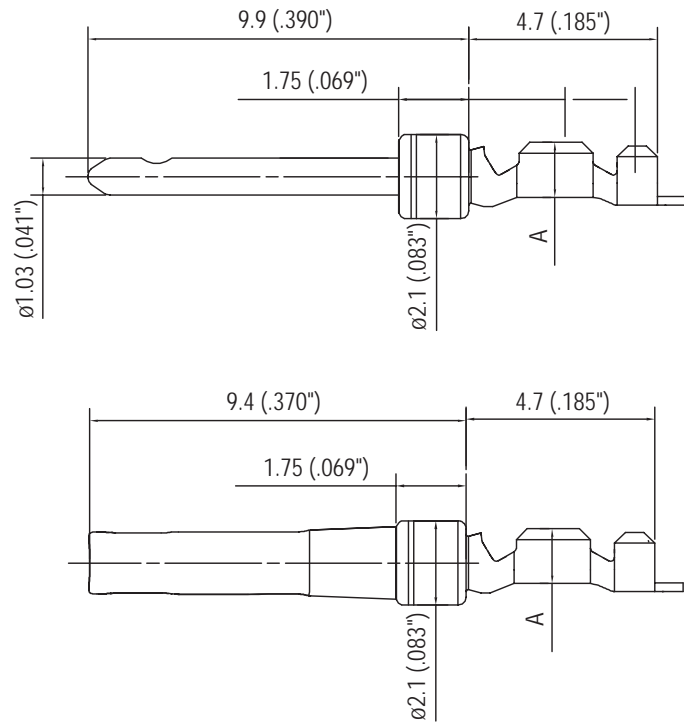
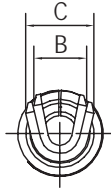

AWG	A	B	C
20-24	1.8 (.071")	1.9 (.075")	2.5 (.098")
24-28	1.4 (.055")	1.5 (.059")	1.7 (.066")

High density:

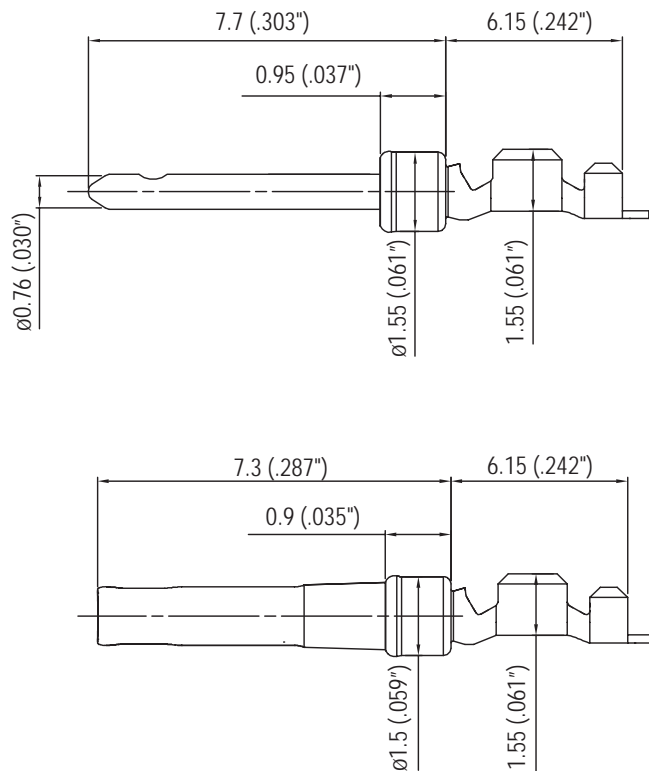
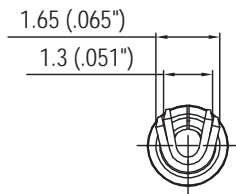

How to order HR (high density)

Housings

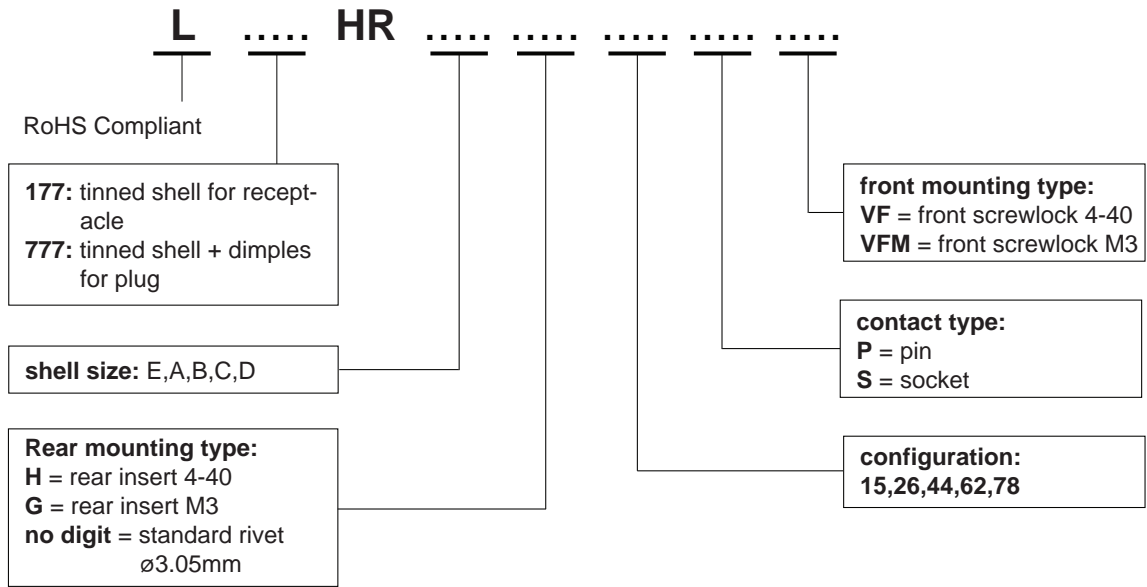

Contacts

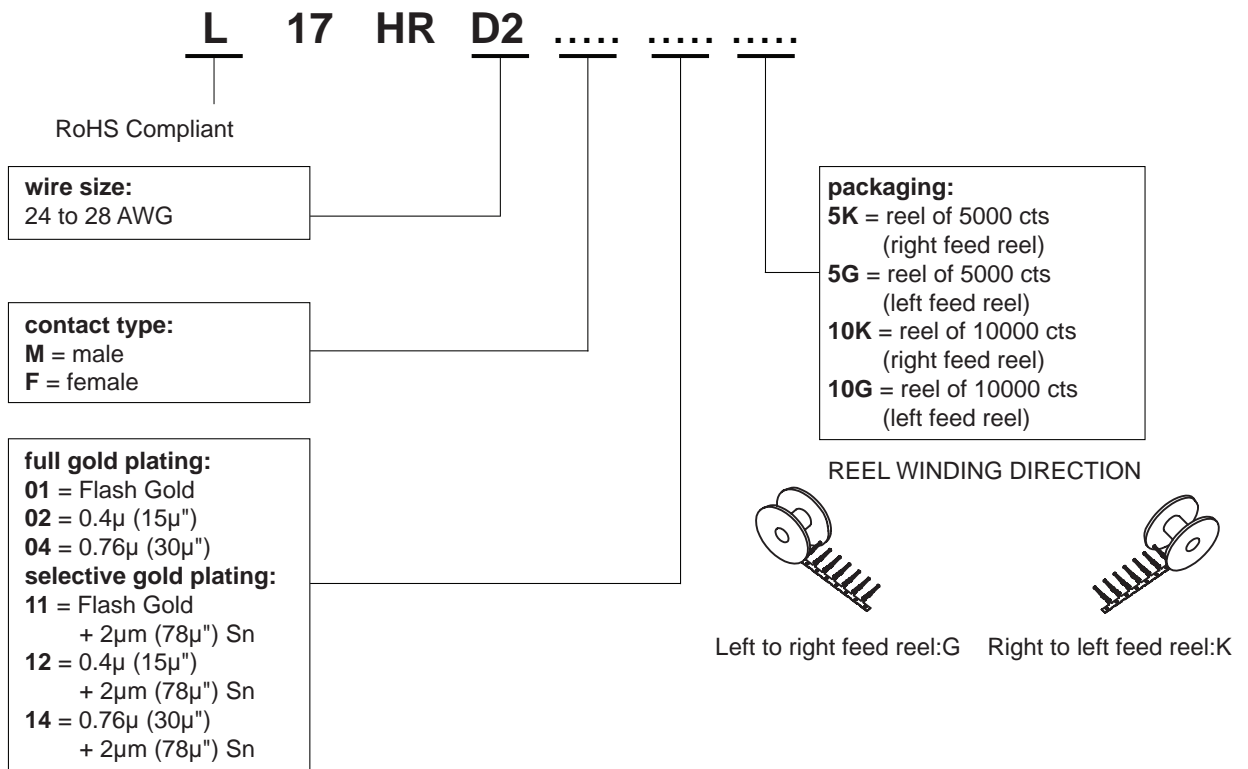

For special request, please consult factory

Tooling for crimp contacts

For standard density crimp contacts: 17RR series

- | | |
|---|-------------|
| • contact insertion and removal tool | 17D 438 SP |
| • hand crimp tool for single contacts AWG 20 to 28 | 17D 440 SP |
| • hand crimp tool for reels of 400 contacts | FA 0000 762 |
| crimp dies: AWG 20 to 24 | FA 0000 104 |
| crimp dies: AWG 24 to 28 | FA 0000 102 |
| • stripping box | FE 0400 |
| • automatic crimp machine for reels of 2000 to 10000 contacts | 970 MC |
| crimp dies: AWG 20 to 24 | 968 MC |
| crimp dies: AWG 24 to 28 | 972 MC |

For high density crimp contacts: 17HR series

- | | |
|---|--------|
| • automatic crimp machine for reels of 2000 to 10000 contacts | 970 MC |
| crimp dies: AWG 24 to 28 | 973 MC |

Do not hesitate to contact us for further information



Amphenol

Amphenol IT & Communication Products

Block A3/A4, The 4th Industrial District of
Industrial Headquarters, Dong Keng Road
Gong Ming Town, Shen Zhen China
Fax: +86(0)755 2754 9955

Technical Support

Tel: +86(0)755 2717 7945
Info-dsub@amphenol.com.cn
<http://www.dsubconnector.com>

X-ON Electronics

Largest Supplier of Electrical and Electronic Components

Click to view similar products for [D-Sub Contacts](#) category:

Click to view products by [Amphenol](#) manufacturer:

Other Similar products are found below :

[173112-0723](#) [173112-0393](#) [173112-0389](#) [173112-0750](#) [173112-0912](#) [FMP009P104](#) [FMP010P104](#) [FMP010S104](#) [FMP016P104](#)
[FMP016S104](#) [FMP051S110](#) [FMX006S128B](#) [124C25029X](#) [131A11039X](#) [132A11019X](#) [132J22039X](#) [132A11029X](#) [132A12059X](#)
[132C12029X](#) [RMPIR01S02E2RLF](#) [DM53744-1](#) [1757912-1](#) [188582-000](#) [162A11839X](#) [162A11889X](#) [1757913-1](#) [FK20S18-02V_100](#)
[FMP006S110](#) [FMP009S104](#) [FMP139S115](#) [212558-1](#) [D02-22-26P-10000](#) [L17DM53744217](#) [D-610-10CS2820](#) [030-1955-000](#) [030-50634](#)
[053744-0098](#) [053744-0099](#) [053745-0105](#) [053745-0111](#) [601064N004](#) [601098N003](#) [6-745288-2](#) [D-610-10CS2962](#) [86303057NLF](#)
[DM537425001NCLF](#) [131A11019X](#) [173112-0045](#) [162A11819X](#) [1731120397](#)