

REV. A	ECN NO.	DATE	SIGN	DESCRIPTION
Initial Release		2010/07/27	Doreen	Change REV.01 to REV.A

THIS DOCUMENT IS SUBJECT TO CHANGE WITHOUT NOTICE. IT IS CONFIDENTIAL AND A PROPERTY OF Amphenol LTW. DISCLOSURE TO THIRD PARTY HAS TO BE AUTHORIZED BY Amphenol LTW.

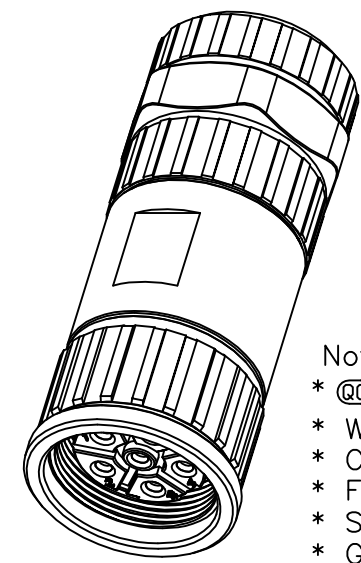
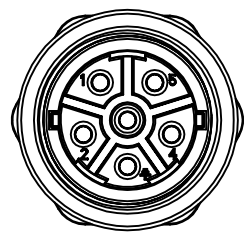
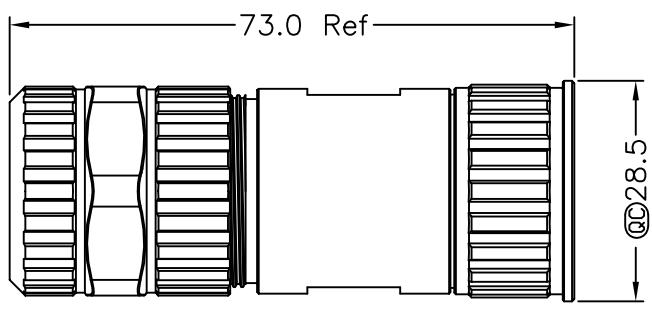
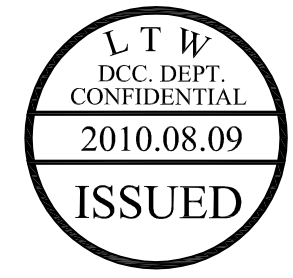
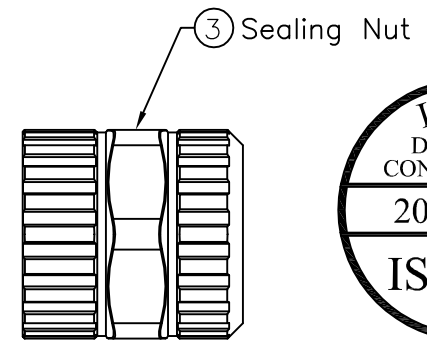
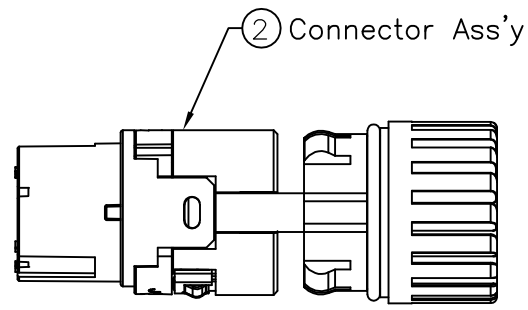
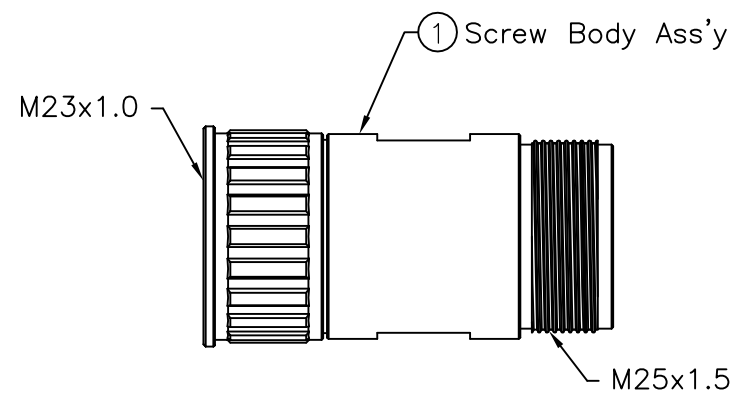

- Note:
- * @@ Important Dimension.
 - * Waterproof Rate: IP67.
 - * Connector: Nylon, Black.
 - * Female Pin: Copper Alloy, Gold Plated.
 - * Screw Nut: Copper Alloy, Nickel Plated.
 - * Gasket: Silicone, UL94V-0, Gray
 - * Recommended Gauge: 14Awg, 12 Awg
 - * Cable OD: B1: Ø8.5~Ø12mm ; B2: Ø12~Ø17.5mm

UNIT:mm		TITLE	M23 Panel ASS'Y Type, F CON, F PIN		Amphenol LTW		ITEM NO	LJ23-06DFFC-SL7001	DRAWN BY	Doreen	DATE	2010/08/02
TOLERANCE	.X ±0.25 .XX ±0.1 .XXX ±0.05 ANGLES ±1'	SCALE	Free	SHEET	1 OF 2	安費諾亮泰企業股份有限公司	DWG NO	LJ23-06DFFC-SL7001	CHECKED BY	Winnie	DATE	2010/08/02
REV.	A	SIZE	A4	@C	:Inspection Item		CUSTOMER	ALTW	APPROVED BY	Kevin	DATE	2010/08/02

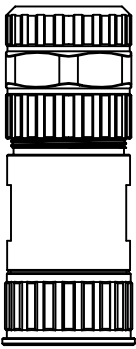
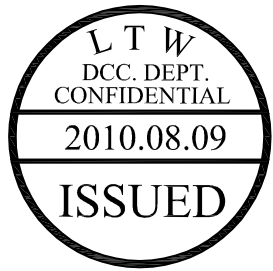

(A包裝)

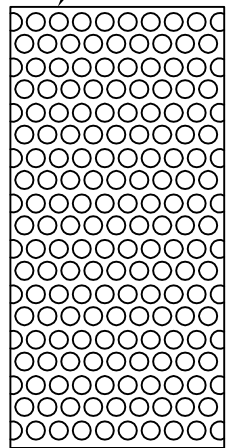

⑥ Bubble Bag

Female Pin ④

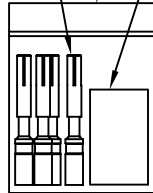

(B包裝)

⑦ 1號由任袋

⑤ Gasket B1

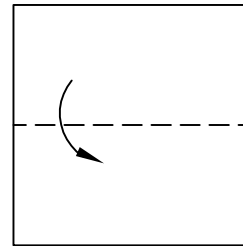

第一折

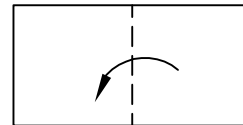

第二折

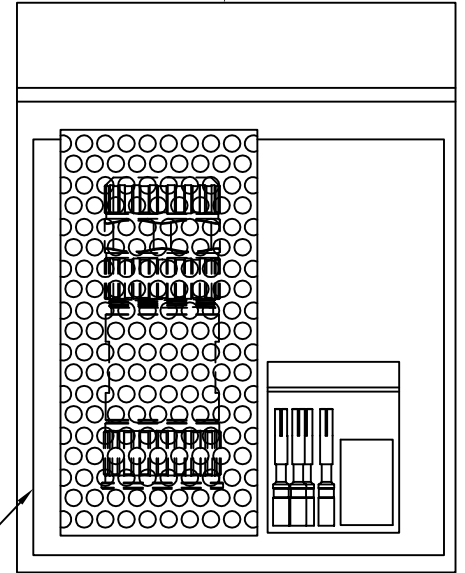

⑧ 6號由任袋

⑨ 組裝說明書



包裝方式

A包裝: 將 ① ② ③ 組裝完成後裝入 ⑥ 氣泡袋中

B包裝: 將 ④ ⑤ 裝入 ⑦ 1號由任袋中

最後將 A 包裝與 B 包裝及 ⑨ 組裝說明書一同裝入 ⑧ 6號由任袋中, 即放入紙箱

REV. A	ECN NO.	DATE	SIGN	DESCRIPTION
Initial Release		2010/07/27	Doreen	Change REV.01 to REV.A

UNIT:mm	
TOLERANCE	
.X	±0.25
.XX	±0.1
.XXX	±0.05
ANGLES	±1'

TITLE		M23 Panel ASS'Y Type, F CON, F PIN	
SCALE	Free	SHEET	2 OF 2
REV. A	SIZE A4	Ⓞ :Inspection Item	

Amphenol LTW
安費諾亮泰企業股份有限公司

ITEM NO	LJ23-06DFFC-SL7001
DWG NO	LJ23-06DFFC-SL7001
CUSTOMER	ALTW

DRAWN BY	Doreen
CHECKED BY	Winnie
APPROVED BY	Kevin

DATE	2010/08/02
DATE	2010/08/02
DATE	2010/08/02

THIS DOCUMENT IS SUBJECT TO CHANGE WITHOUT NOTICE. IT IS CONFIDENTIAL AND A PROPERTY OF Amphenol LTW. DISCLOSURE TO THIRD PARTY HAS TO BE AUTHORIZED BY Amphenol LTW.

X-ON Electronics

Largest Supplier of Electrical and Electronic Components

Click to view similar products for [Circular Metric Connectors](#) category:

Click to view products by [Amphenol](#) manufacturer:

Other Similar products are found below :

[600X518037X](#) [6STD15PCR99B70A](#) [8R4000A16M020](#) [8R5000A16M005](#) [1200910002](#) [1203580030](#) [1200910008](#) [1200910011](#) [1300140094](#)
[130203-0054](#) [1300140026](#) [1300150099](#) [1-3637-600-5205](#) [1612618](#) [21036836414](#) [8R4006A16M010](#) [1R3006A20M005](#) [41-40011](#) [42-00006](#)
[42-01015](#) [4-22279-4](#) [4-22281-1](#) [4-22284-9](#) [43-00113](#) [43-01203](#) [41-40013](#) [42-00008](#) [43-00343](#) [43-01026](#) [43-01162](#) [43-01173](#) [43-10000](#)
[XS3P-M421-2](#) [600X518050X](#) [8R5006A16M020](#) [8R5006A16M005](#) [8R4000A16M010](#) [6-22279-3](#) [1605332](#) [N03FA03144](#) [1300140077](#) [43-](#)
[16213](#) [43-01338](#) [XS2RD4265](#) [XS2R-D426-1](#) [XS8A-0441](#) [859RD04-103R004](#) [860RD04-113R004](#) [860RD04-213R004](#) [1-213245-2](#)