

THIS DOCUMENT IS SUBJECT TO CHANGE WITHOUT NOTICE. IT IS CONFIDENTIAL AND A PROPERTY OF Amphenol LTW. DISCLOSURE TO THIRD PARTY HAS TO BE AUTHORIZED BY Amphenol LTW.

| | | | | |
|------|-----------------|------------|-------|------------------------|
| REV. | ECN NO. | DATE | SIGN | DESCRIPTION |
| A | Initial Release | 2018/01/13 | Ethan | Chnage Rev.01 To Rev.A |
| | | | | |

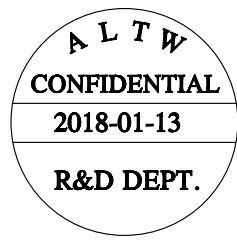
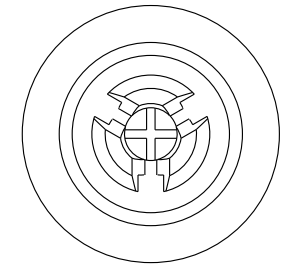
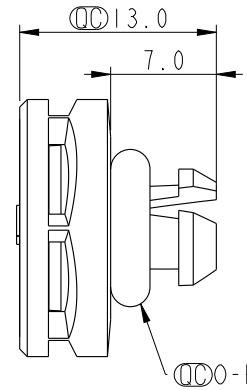
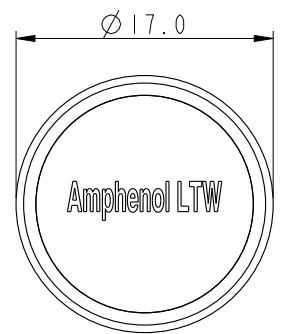
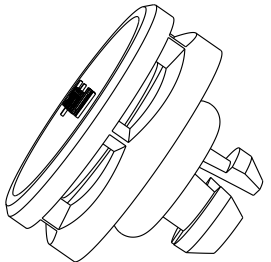

| 成品料號(Product no.) | 透氣量ml/min@70mbar | 主體顏色(Body Colour) | O-Ring Color | 疏油性(Oleophobic) | Waterproof Rate |
|-------------------|------------------|-------------------|--------------|-----------------|-----------------|
| VENT-PQINGY-08001 | >550 | Gray | Black | Y | IP68/IP69K |
| VENT-PQINBK-08001 | >550 | Black | Black | Y | IP68/IP69K |
| VENT-PQINGY-N8001 | >1000 | Gray | Blue | N | IP68/IP69K |
| VENT-PQINBK-N8001 | >1000 | Black | Blue | N | IP68/IP69K |
| VENT-PQINGY-08002 | >1000 | Gray | Green | Y | IP68/IP69K |
| VENT-PQINBK-08002 | >1000 | Black | Green | Y | IP68/IP69K |
| VENT-PQINGY-N8002 | >3000 | Gray | Red | N | IP68/IP69K |
| VENT-PQINBK-N8002 | >3000 | Black | Red | N | IP68/IP69K |

| | | | | | |
|---|--------------|------------|--------------------|-----------|----------------|
| UNIT : mm | | | TITLE SNAP VENT | | |
| TOLERANCE .X ±0.25 .XX ±0.1 .XXX ±0.05 ANGLES ±1° | SCALE 2:1 | SIZE A4 | SHEET 1 OF 2 | REV. A | WC-REV. A.7 |
| | | | ◎: Inspection item | | |

| | | | | |
|--------------------------------------|--|-----------------------------|-----------------------|--------------------|
| Amphenol LTW 安費諾亮泰企業股份有限公司 | | ITEM NO | DRAWN BY Ethan | DATE 2018-01-13 |
| | | DWG NO VENT-PQIXXX-XXXXX | CHECKED BY Feng-li | DATE 2018-01-13 |
| | | CUSTOMER ALTW | APPROVED BY Jerry | DATE 2018-01-13 |

THIS DOCUMENT IS SUBJECT TO CHANGE WITHOUT NOTICE. IT IS CONFIDENTIAL AND A PROPERTY OF Amphenol LTW. DISCLOSURE TO THIRD PARTY HAS TO BE AUTHORIZED BY Amphenol LTW.

| REV. | ECN NO. | DATE | SIGN | DESCRIPTION |
|------|---------|------|------|-------------|
| | | | | |
| | | | | |
| | | | | |

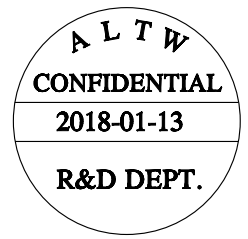
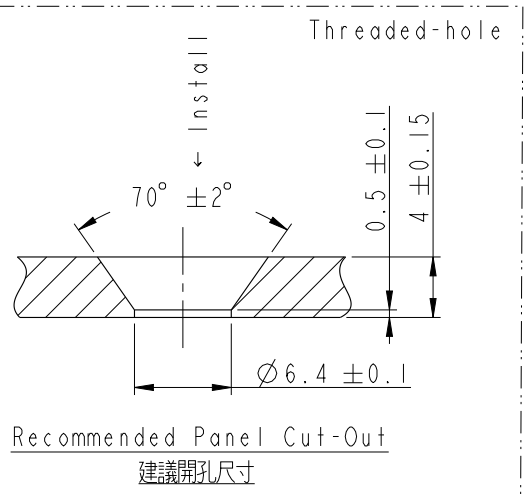
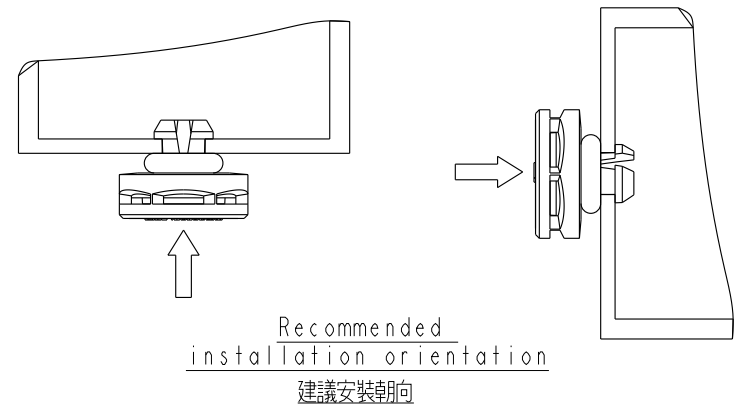

- Note:
- * \varnothing Important Dimension.
 - * Cap: Nylon, 94V-0, UV Resistance, UL
 - * Membrane: ePTFE
 - * Body: Nylon, 94V-0, UV Resistance, UL
 - * O-Ring: Silicone, 94V-0, UL

| | | | |
|---|----------------|---------------------------------|--------------------|
| UNIT: mm | | | TITLE SNAP VENT |
| TOLERANCE .X ±0.25 .XX ±0.1 .XXX ±0.05 ANGLES ±1° | SCALE 2:1 | SIZE A4 | SHEET 2 OF 2 |
| REV. A | WC-REV. A.7 | \varnothing : Inspection item | |

Amphenol LTW
安費諾亮泰企業股份有限公司

| | | |
|------------------------------|-----------------------|--------------------|
| ITEM NO. | DRAWN BY Ethan | DATE 2018-01-13 |
| DWG NO. VENT-PQ1XXX-XXXXX | CHECKED BY Feng-li | DATE 2018-01-13 |
| CUSTOMER ALTW | APPROVED BY Jerry | DATE 2018-01-13 |

X-ON Electronics

Largest Supplier of Electrical and Electronic Components

Click to view similar products for [Enclosures, Boxes & Cases](#) *category:*

Click to view products by [Amphenol](#) *manufacturer:*

Other Similar products are found below :

[585-R-WH-PK](#) [M-10-PLATED](#) [60566-01-000](#) [HPL-9VB BATT DOOR](#) [M18-PLTD](#) [M-21-PLATED](#) [63310-01-000](#) [6711GSKT](#)
[71884-29-028](#) [LH45-100 Black](#) [72868-510-000](#) [CNS-0000 Black](#) [72883-510-000](#) [CNS-0101 Black](#) [72906-510-000](#) [CNS-0407 Black](#) [73092-](#)
[510-000](#) [CNM-0101 Black](#) [73105-510-000](#) [CNL-0101 Black](#) [73395-510-039](#) [CNS-0006 Bone](#) [74016-510-000](#) [CNL-0006 Black](#) [74257-510-000](#)
[CNL-0004](#) [MDC-1183-PLAIN-ALUM](#) [MDC-1183-PTD](#) [MDC-13104-PTD](#) [MDC-321-PTD](#) [MDC-973-PTD](#) [76](#) [77153-01-028](#) [FLX6030](#)
[83535-01-508](#) [90026-501-000](#) [PS36-200](#) [116-508](#) [120-407](#) [120-910](#) [127-908](#) [130-008](#) [1301170079](#) [1322GSKTEP](#) [1325GSKT3](#) [138-PLAIN](#)
[1434-1210](#) [EAS-500 \(BLACK ANO\)](#) [1804RP-RB-PK](#) [190-005](#) [2202307](#) [KAB3321 BLACK](#) [KAB3421](#) [2697466](#) [S52213](#) [2901123](#) [2901699](#)
[A0645271](#) [A20P20](#) [2106-IR](#) [PERF-850-PLN](#)