

THIS DOCUMENT IS SUBJECT TO CHANGE WITHOUT NOTICE. IT IS CONFIDENTIAL AND A PROPERTY OF Amphenol LTW. DISCLOSURE TO THIRD PARTY HAS TO BE AUTHORIZED BY Amphenol LTW.

REV.	ECN NO.	DATE	SIGN	DESCRIPTION
A	Initial Release	2018/01/13	Ethan	Chnage Rev.01 To Rev.A

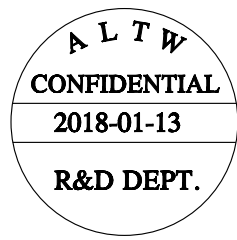
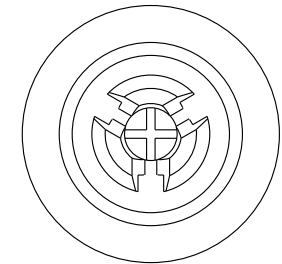
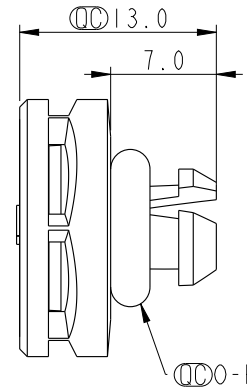
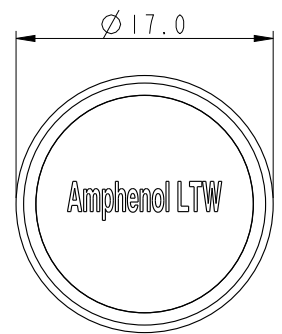
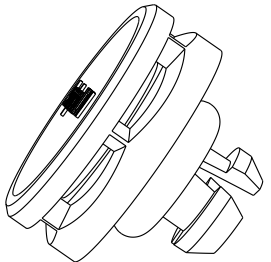

成品料號(Product no.)	透氣量ml/min@70mbar	主體顏色(Body Colour)	O-Ring Color	疏油性(Oleophobic)	Waterproof Rate
VENT-PQINGY-08001	>550	Gray	Black	Y	IP68/IP69K
VENT-PQINBK-08001	>550	Black	Black	Y	IP68/IP69K
VENT-PQINGY-N8001	>1000	Gray	Blue	N	IP68/IP69K
VENT-PQINBK-N8001	>1000	Black	Blue	N	IP68/IP69K
VENT-PQINGY-08002	>1000	Gray	Green	Y	IP68/IP69K
VENT-PQINBK-08002	>1000	Black	Green	Y	IP68/IP69K
VENT-PQINGY-N8002	>3000	Gray	Red	N	IP68/IP69K
VENT-PQINBK-N8002	>3000	Black	Red	N	IP68/IP69K

UNIT : mm			TITLE SNAP VENT
TOLERANCE .X ±0.25 .XX ±0.1 .XXX ±0.05 ANGLES ±1°	SCALE 2:1	SIZE A4	SHEET 1 OF 2
REV. A	WC-REV. A.7	◎◎: Inspection item	

Amphenol LTW
安費諾亮泰企業股份有限公司

ITEM NO	DRAWN BY Ethan	DATE 2018-01-13
DWG NO VENT-PQIXXX-XXXXX	CHECKED BY Feng-li	DATE 2018-01-13
CUSTOMER ALTW	APPROVED BY Jerry	DATE 2018-01-13

THIS DOCUMENT IS SUBJECT TO CHANGE WITHOUT NOTICE. IT IS CONFIDENTIAL AND A PROPERTY OF Amphenol LTW. DISCLOSURE TO THIRD PARTY HAS TO BE AUTHORIZED BY Amphenol LTW.

REV.	ECN NO.	DATE	SIGN	DESCRIPTION

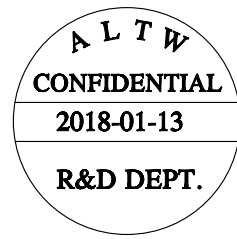
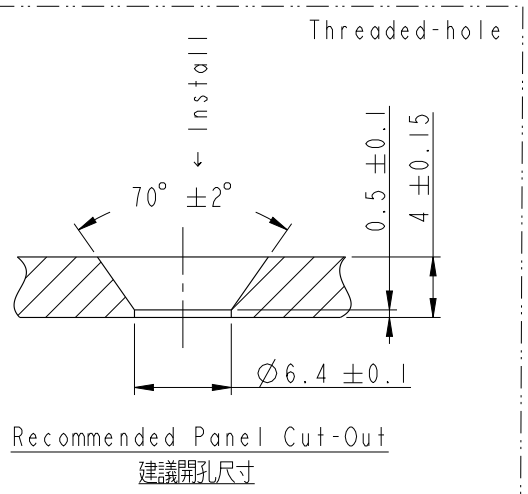
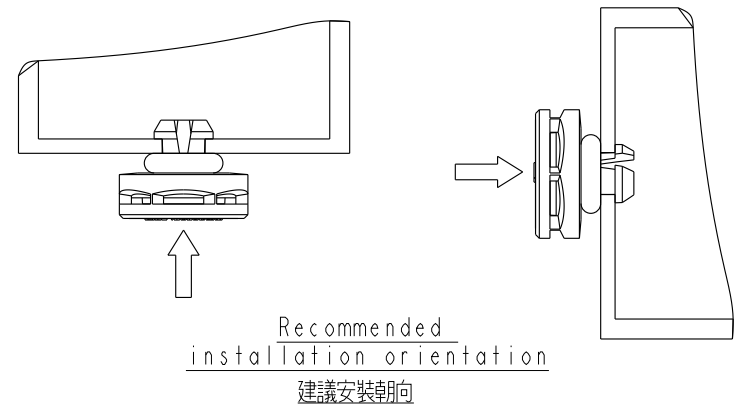

- Note:
- * \varnothing Important Dimension.
 - * Cap: Nylon, 94V-0, UV Resistance, UL
 - * Membrane: ePTFE
 - * Body: Nylon, 94V-0, UV Resistance, UL
 - * O-Ring: Silicone, 94V-0, UL

A	UNIT: mm			TITLE SNAP VENT			ITEM NO	DRAWN BY Ethan	DATE 2018-01-13
	TOLERANCE .X ±0.25 .XX ±0.1 .XXX ±0.05 ANGLES ±1°	SCALE 2:1	SIZE A4	SHEET 2 OF 2	REV. A	WC-REV. A.7	DWG NO VENT-PQ1XXX-XXXXX	CHECKED BY Feng-li	DATE 2018-01-13
	Amphenol LTW 安費諾亮泰企業股份有限公司			CUSTOMER ALTW	APPROVED BY Jerry	DATE 2018-01-13	W10814-03-0001A1		

X-ON Electronics

Largest Supplier of Electrical and Electronic Components

Click to view similar products for [Enclosures, Boxes & Cases](#) category:

Click to view products by [Amphenol](#) manufacturer:

Other Similar products are found below :

[585-R-WH-PK](#) [M-10-PLATED](#) [60566-01-000](#) [HPL-9VB BATT DOOR](#) [M18-PLTD](#) [M-21-PLATED](#) [63310-01-000](#) [6711GSKT](#)
[71884-29-028](#) [LH45-100 Black](#) [72868-510-000](#) [CNS-0000 Black](#) [72883-510-000](#) [CNS-0101 Black](#) [72906-510-000](#) [CNS-0407 Black](#) [73092-](#)
[510-000](#) [CNM-0101 Black](#) [73105-510-000](#) [CNL-0101 Black](#) [73395-510-039](#) [CNS-0006 Bone](#) [74016-510-000](#) [CNL-0006 Black](#) [74257-510-000](#)
[CNL-0004](#) [MDC-1183-PLAIN-ALUM](#) [MDC-1183-PTD](#) [MDC-13104-PTD](#) [MDC-321-PTD](#) [MDC-973-PTD](#) [76](#) [77153-01-028](#) [FLX6030](#)
[83535-01-508](#) [90026-501-000](#) [PS36-200](#) [116-508](#) [120-407](#) [120-910](#) [127-908](#) [130-008](#) [1301170079](#) [1322GSKTEP](#) [1325GSKT3](#) [138-PLAIN](#)
[1434-1210](#) [EAS-500 \(BLACK ANO\)](#) [1804RP-RB-PK](#) [190-005](#) [2202307](#) [KAB3321 BLACK](#) [KAB3421](#) [2697466](#) [S52213](#) [2901123](#) [2901699](#)
[A0645271](#) [A20P20](#) [2106-IR](#) [PERF-850-PLN](#)