

REV.	ECN NO.	DATE	SIGN	DESCRIPTION
B	LEN1580142 ~153	2015/08/10	Feng_Li	Add Black PVC Cable
C	LEN1680662~679	2016/08/13	Yulong_wang	Add 6Pin & IP69K.
D	LEN1750097~102	2017/04/06	Lingpeng	Change The Cable OD

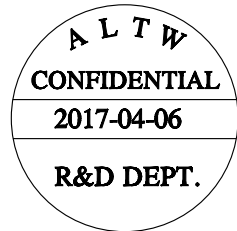
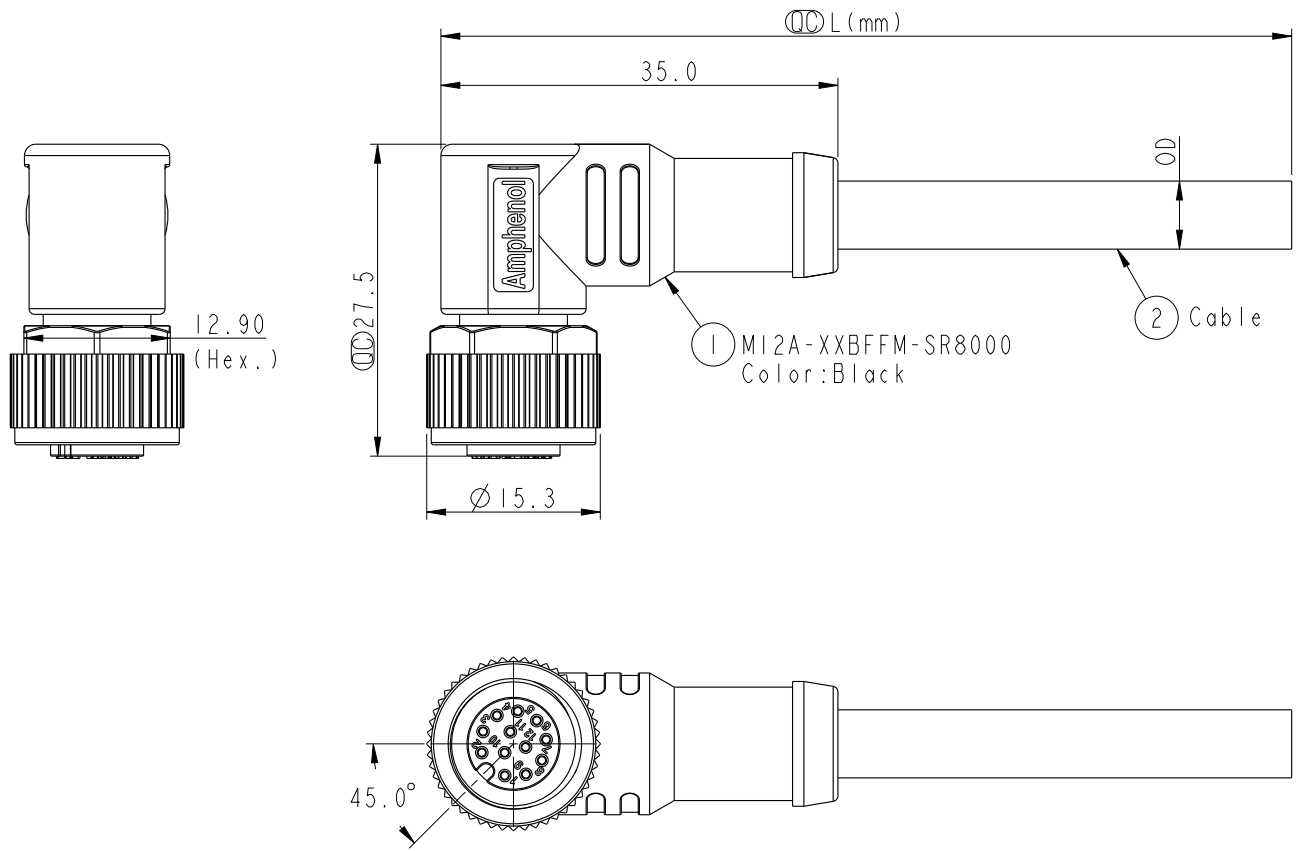

Notes:

- \*  $\varnothing$  Important Dimension.
- $\triangle C$  \* Waterproof Rate: IP68, IP69K.
- \* Connector: PU+GF, Black.
- \* Female Pin: Copper Alloy, Gold Plated.
- \* Screw Nut: Zinc Alloy, Nickel Plated.
- \* Outer Mold: PU, Black.
- $\triangle B$  \* Cable: (A) UL2517, PVC Jacket, Yellow.  
(B) UL20549, PUR Jacket, Black.  
(D) UL2517, PVC Jacket, Black.
- \* Rated Voltage: 3 & 4Pin 250V dc. or ac.  
5Pin 60V dc. or ac.  
6~12Pin 30V dc. or ac.
- \* Rated Current: 3~5Pin 4A  
6~8Pin 2A  
10~12Pin 1.5A
- \* Operating Temperature: -25~85°C
- \* Cable Length Tolerance: 01M:±40mm  
02M~05M:±60mm  
06M~10M:±100mm  
11M~30M:±200mm  
31M~99M:±500mm

UNIT:mm		
TOLERANCE ±0.5mm		

TITLE M12 A Type Cable 90° Female Conn.		
SCALE 3:2	SIZE A4	SHEET 1 OF 3
REV. D	WC-REV. A.2	$\varnothing$ : Inspection item

**Amphenol LTW**  
安費諾亮泰企業股份有限公司

ITEM NO	DRAWN BY Lingpeng	DATE 2017-04-06
DWG NO M12A-XXBFFM-SR8XXX	CHECKED BY Ma Fei	DATE 2017-04-06
CUSTOMER ALTW	APPROVED BY Jerry	DATE 2017-04-06

THIS DOCUMENT IS SUBJECT TO CHANGE WITHOUT NOTICE. IT IS CONFIDENTIAL AND A PROPERTY OF Amphenol LTW. DISCLOSURE TO THIRD PARTY HAS TO BE AUTHORIZED BY Amphenol LTW.

THIS DOCUMENT IS SUBJECT TO CHANGE WITHOUT NOTICE. IT IS CONFIDENTIAL AND A PROPERTY OF Amphenol LTW. DISCLOSURE TO THIRD PARTY HAS TO BE AUTHORIZED BY Amphenol LTW.

Contacts	Cable Jacket	Cable OD	AWG	Item No.
△B	PVC	6.0	26	M12A-12BFFM-SR8DXX
				M12A-10BFFM-SR8DXX
△C	PVC	5.5	24	M12A-08BFFM-SR8DXX
				M12A-06BFFM-SR8DXX
	PVC	5.1	22	M12A-05BFFM-SR8DXX
				M12A-04BFFM-SR8DXX
	PVC	4.8	22	M12A-03BFFM-SR8DXX
				M12A-12BFFM-SR8BXX
△D	PUR	6.0	26	M12A-10BFFM-SR8BXX
				M12A-08BFFM-SR8BXX
△C	PUR	5.0	24	M12A-06BFFM-SR8BXX
				M12A-05BFFM-SR8BXX
△D	PUR	4.4	22	M12A-04BFFM-SR8BXX
				M12A-03BFFM-SR8BXX
	PVC	6.0	26	M12A-12BFFM-SR8AXX
				M12A-10BFFM-SR8AXX
△C	PVC	5.5	24	M12A-08BFFM-SR8AXX
				M12A-06BFFM-SR8AXX
	PVC	5.1	22	M12A-05BFFM-SR8AXX
				M12A-04BFFM-SR8AXX
	PVC	4.8	22	M12A-03BFFM-SR8AXX
				M12A-03BFFM-SR8AXX

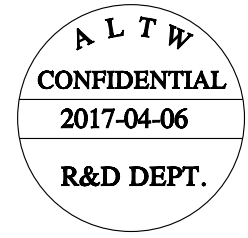
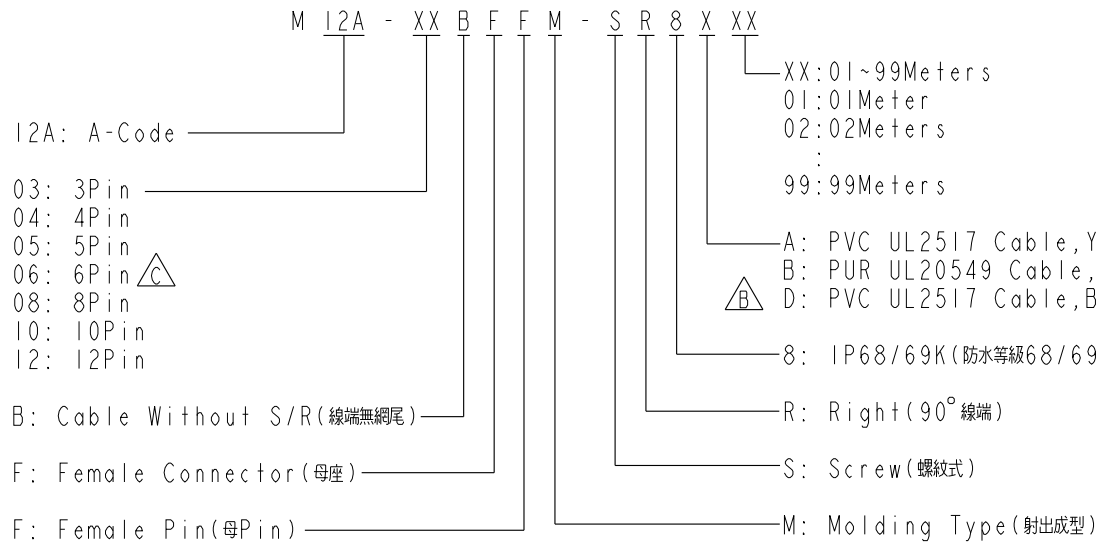

UNIT: mm

TOLERANCE ±0.5mm

TITLE M12 A Type Cable 90° Female Conn.			
SCALE 3:2	SIZE A4	SHEET 2 OF 3	
REV. D	WC-REV. A.2	QC: Inspection item	

**Amphenol LTW**  
 安費諾亮泰企業股份有限公司

ITEM NO	DRAWN BY Lingpeng	DATE 2017-04-06
DWG NO M12A-XXBFFM-SR8XXX	CHECKED BY Ma Fei	DATE 2017-04-06
CUSTOMER ALTW	APPROVED BY Jerry	DATE 2017-04-06

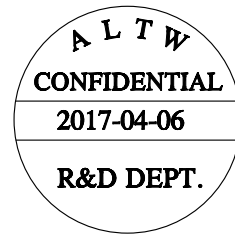

F  
E  
D  
C  
B  
A

5	--		5	--		5	Gray	灰	5	--		12	--		12	Red/Blue	紅/藍
4	Black	黑	4	Black	黑	4	Black	黑	4	Black	黑	11	--		11	Gray/Pink	灰/粉
3	Blue	藍	3	Blue	藍	3	Blue	藍	3	Blue	藍	10	Violet	紫	10	Violet	紫
2	--		2	White	白	2	White	白	2	White	白	9	Black	黑	9	Black	黑
1	Brown	棕	1	Brown	棕	1	Brown	棕	1	White	白	8	Red	紅	8	Red	紅
												7	Blue	藍	7	Blue	藍
												6	Pink	粉	6	Pink	粉
												5	Gray	灰	5	Gray	灰
												4	Yellow	黃	4	Yellow	黃
												3	Green	綠	3	Green	綠
												2	Brown	棕	2	Brown	棕
												1	White	白	1	White	白

Pin Out

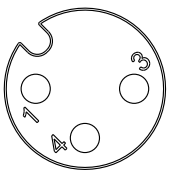

3P

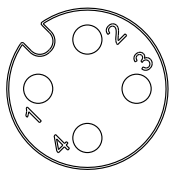

4P

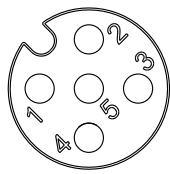

5P



6P

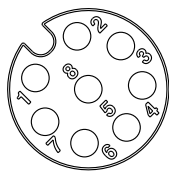

8P

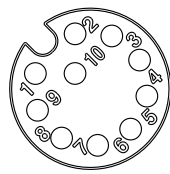

10P

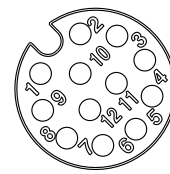

12P

Pin Assignments Front View

UNIT: mm		TOLERANCE ±0.5mm	TITLE M12 A Type Cable 90° Female Conn.		
			SCALE 3:2	SIZE A4	SHEET 3 OF 3
			REV. D	WC-REV. A.2	
			Inspection item		

**Amphenol LTW**  
安費諾亮泰企業股份有限公司

ITEM NO.	DRAWN BY Lingpeng	DATE 2017-04-06
DWG NO. M12A-XXBFFM-SR8XXX	CHECKED BY Ma Fei	DATE 2017-04-06
CUSTOMER ALTW	APPROVED BY Jerry	DATE 2017-04-06

## X-ON Electronics

Largest Supplier of Electrical and Electronic Components

*Click to view similar products for [Sensor Cables / Actuator Cables](#) category:*

*Click to view products by [Amphenol](#) manufacturer:*

Other Similar products are found below :

[60963](#) [60964](#) [703000D02F2002](#) [703001D02F0602](#) [703001D02F300](#) [704000D02F120](#) [773032K02F030](#) [802027107404-1](#) [802027213811-1](#)  
[804001A09M150](#) [805001A09M0502](#) [84914-0235](#) [84914-0237](#) [885030A09M020](#) [8R4J30E03C3003](#) [1200651332](#) [1200651713](#) [1200660844](#)  
[1200660845](#) [1200661173](#) [1200680071](#) [1200720053](#) [1200720081](#) [1200720099](#) [1200720217](#) [1200800231](#) [1200860125](#) [1200870123](#)  
[1200980102](#) [1200650267](#) [1200650298](#) [1200660183](#) [1200660782](#) [1200660849](#) [1200661295](#) [1200661297](#) [1200661342](#) [1200661343](#)  
[1200670080](#) [1200670220](#) [1200680331](#) [1200720252](#) [1200730184](#) [1200860344](#) [1200870359](#) [1200870643](#) [1200980008](#) [1200980031](#)  
[1210502211](#) [1210400542](#)