

THIS DOCUMENT IS SUBJECT TO CHANGE WITHOUT NOTICE. IT IS CONFIDENTIAL AND A PROPERTY OF Amphenol LTW. DISCLOSURE TO THIRD PARTY HAS TO BE AUTHORIZED BY Amphenol LTW.

REV.	ECN NO.	DATE	SIGN	DESCRIPTION
B	LEN1580154-165	2015/08/10	Feng_Li	Add Black PVC Cable
C	LEN1680979-996 LEN1681012-015	2016/08/13	Yulong_wang	Add 6Pin & IP69K.

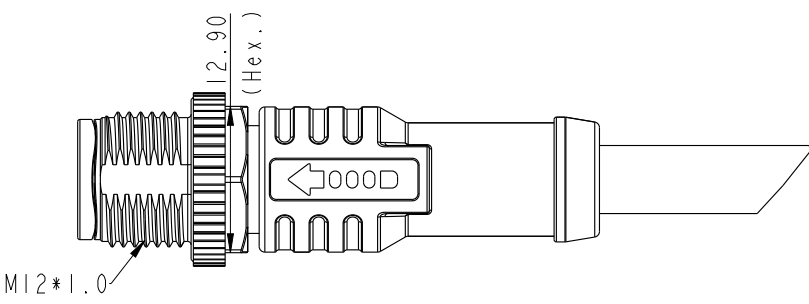
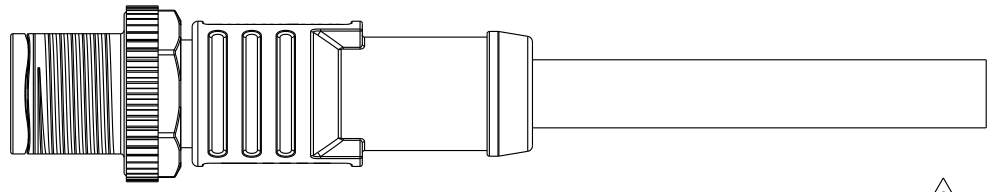
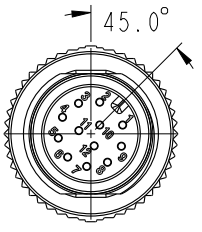
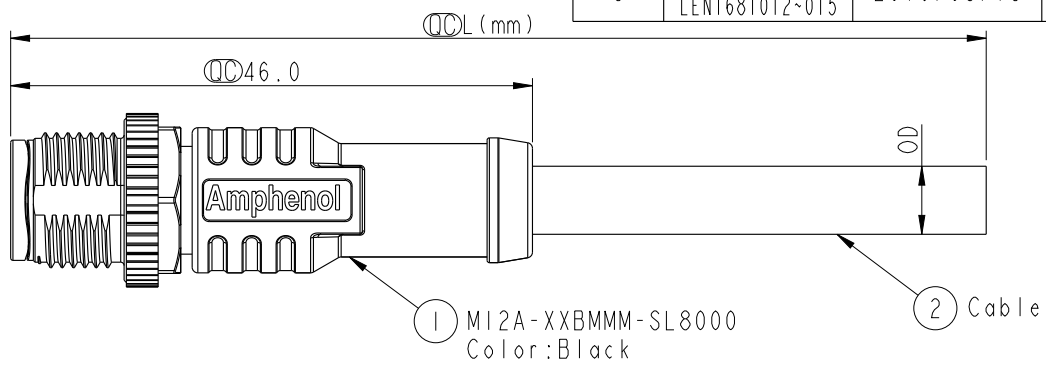
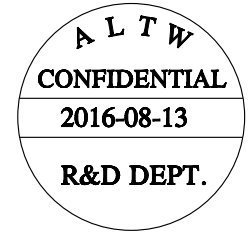

- Notes:
- * \varnothing Important Dimension.
 - * Waterproof Rate: IP68., IP69K.
 - * Connector: PU+GF,Black.
 - * Male Pin: Copper Alloy, Gold Plated.
 - * Screw Nut: Zinc Alloy, Nickel Plated.
 - * Outer Mold: PU,Black.
 - * Cable: (A) UL2517,PVC Jacket, Yellow.
(B) UL20549,PUR Jacket,Black.
(D) UL2517,PVC Jacket,Black.
 - * Rated Voltage: 3 & 4Pin 250V dc. or ac.
5Pin 60V dc. or ac.
6~12Pin 30V dc. or ac.
 - * Rated Current: 3~5Pin 4A
6~8Pin 2A
10~12Pin 1.5A
 - * Operating Temperature: -25~85°C
 - * Cable Length Tolerance: 01M:±40mm
02M~05M:±60mm
06M~10M:±100mm
11M~30M:±200mm
31M~99M:±500mm

UNIT:mm		
TOLERANCE		
±0.5mm		

TITLE MI2 A Type Cable Male Conn.			
SCALE 3:2	SIZE A4	SHEET 1 OF 3	
REV. C	WC-REV. A.3	\varnothing : Inspection item	

Amphenol LTW
安費諾亮泰企業股份有限公司

ITEM NO	DRAWN BY Yulong_wang	DATE 2016-08-13
DWG NO MI2A-XXBMMM-SL8XXX	CHECKED BY Jinhai	DATE 2016-08-13
CUSTOMER ALTW	APPROVED BY Jerry	DATE 2016-08-13

THIS DOCUMENT IS SUBJECT TO CHANGE WITHOUT NOTICE. IT IS CONFIDENTIAL AND A PROPERTY OF Amphenol LTW. DISCLOSURE TO THIRD PARTY HAS TO BE AUTHORIZED BY Amphenol LTW.

Contacts	Cable Jacket	Cable OD	AWG	Item No.
△B	PVC	6.0	26	M12A-12BMMM-SL8DXX
				M12A-10BMMM-SL8DXX
△C	PVC	5.5	24	M12A-08BMMM-SL8DXX
				M12A-06BMMM-SL8DXX
	PUR	5.1	22	M12A-05BMMM-SL8DXX
				M12A-04BMMM-SL8DXX
	PUR	4.8	22	M12A-03BMMM-SL8DXX
				M12A-12BMMM-SL8BXX
	PUR	6.0	26	M12A-10BMMM-SL8BXX
				M12A-08BMMM-SL8BXX
△C	PUR	5.5	24	M12A-06BMMM-SL8BXX
				M12A-05BMMM-SL8BXX
	PUR	5.1	22	M12A-04BMMM-SL8BXX
				M12A-03BMMM-SL8BXX
	PVC	4.8	22	M12A-12BMMM-SL8AXX
				M12A-10BMMM-SL8AXX
△C	PVC	6.0	26	M12A-08BMMM-SL8AXX
				M12A-06BMMM-SL8AXX
	PVC	5.5	24	M12A-05BMMM-SL8AXX
				M12A-04BMMM-SL8AXX
	PVC	5.1	22	M12A-03BMMM-SL8AXX
				M12A-03BMMM-SL8AXX

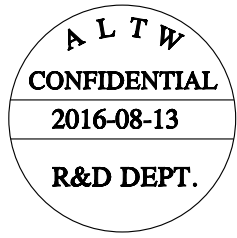

M 12A - XX B M M M - S L 8 X XX

12A: A-Code

- 03: 3Pin
- 04: 4Pin
- 05: 5Pin
- 06: 6Pin △C
- 08: 8Pin
- 10: 10Pin
- 12: 12Pin

B: Cable Without S/R (線端無網尾)

M: Male Connector (公座)

M: Male Pin (公Pin)

- XX: 01~99Meters
- 01: 01Meter
- 02: 02Meters
- ...
- 99: 99Meters

- A: PVC UL2517 Cable, Yellow (PVC黃色外被線材)
- B: PUR UL20549 Cable, Black (PUR黑色外被線材)
- D: PVC UL2517 Cable, Black (PVC黑色外被線材) △B

8: IP68/69K (防水等級68/69K) △C

L: Straight (180° 線端)

S: Screw (螺紋式)

M: Molding Type (射出成型)

UNIT:mm	
TOLERANCE	±0.5mm

TITLE M12 A Type Cable Male Conn.			
SCALE 3:2	SIZE A4	SHEET 2 OF 3	
REV. C	WC-REV. A.3	QC: Inspection item	

Amphenol LTW
安費諾亮泰企業股份有限公司

ITEM NO	DRAWN BY Yulong_wang	DATE 2016-08-13
DWG NO M12A-XXBMMM-SL8XXX	CHECKED BY Jlnhai	DATE 2016-08-13
CUSTOMER ALTW	APPROVED BY Jerry	DATE 2016-08-13

THIS DOCUMENT IS SUBJECT TO CHANGE WITHOUT NOTICE. IT IS CONFIDENTIAL AND A PROPERTY OF Amphenol LTW. DISCLOSURE TO THIRD PARTY HAS TO BE AUTHORIZED BY Amphenol LTW.

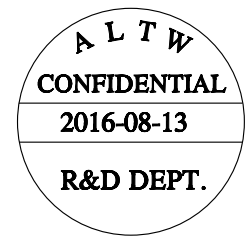

Pin #	Wire	Pin #	Wire	Pin #	Wire	Pin #	Wire	Pin #	Wire	Pin #	Wire	Pin #	Wire
5	--	5	--	5	Gray	8	--	8	Red	12	--	12	Red/Blue
4	Black	4	Black	4	Black	7	Blue	7	Blue	11	--	11	Gray/Pink
3	Blue	3	Blue	3	Blue	6	Pink	6	Pink	10	Violet	10	Violet
2	--	2	White	2	White	5	--	5	Gray	9	Black	9	Black
1	Brown	1	Brown	1	Brown	4	Yellow	4	Yellow	8	Red	8	Red
						3	Green	3	Green	7	Blue	7	Blue
						2	Brown	2	Brown	6	Pink	6	Pink
						1	White	1	White	5	Gray	5	Gray
										4	Yellow	4	Yellow
										3	Green	3	Green
										2	Brown	2	Brown
										1	White	1	White

Pin Out

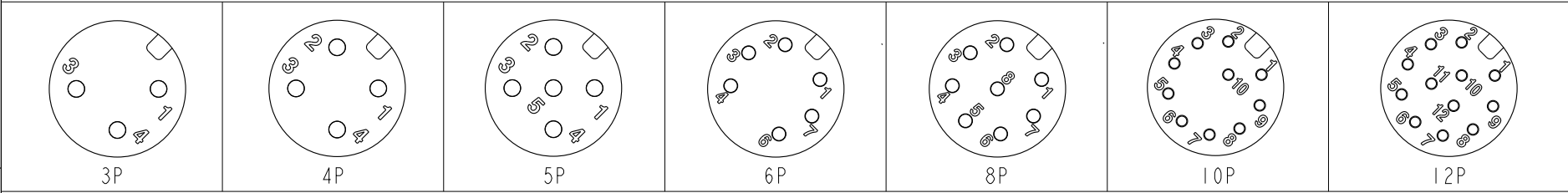

Pin Assignments Front View

UNIT: mm TOLERANCE ±0.5mm	TITLE M12 A Type Cable Male Conn.		<h1>Amphenol LTW</h1> <p>安費諾亮泰企業股份有限公司</p>	ITEM NO	DRAWN BY	DATE	
	SCALE 3:2	SIZE A4		SHEET 3 OF 3	DWG NO M12A-XXBMMM-SL8XXX	CHECKED BY Jinhai	DATE 2016-08-13
	REV. C	WC-REV. A.3		☉: Inspection item	CUSTOMER ALTW	APPROVED BY Jerry	DATE 2016-08-13

X-ON Electronics

Largest Supplier of Electrical and Electronic Components

Click to view similar products for [Sensor Cables / Actuator Cables](#) category:

Click to view products by [Amphenol](#) manufacturer:

Other Similar products are found below :

[60963](#) [60964](#) [M83513/19-F01CP](#) [703000D02F2002](#) [703001D02F0602](#) [703001D02F300](#) [704000D02F120](#) [773032K02F030](#) [802027107404-1](#)
[802027213811-1](#) [804001A09M150](#) [805001A09M0502](#) [84914-0235](#) [84914-0237](#) [885030A09M020](#) [8R4J30E03C3003](#) [1200651332](#)
[1200651713](#) [1200660844](#) [1200660845](#) [1200661173](#) [1200680071](#) [1200720053](#) [1200720081](#) [1200720099](#) [1200720217](#) [1200800231](#)
[1200860125](#) [1200870123](#) [1200980102](#) [1200650267](#) [1200650298](#) [1200660183](#) [1200660782](#) [1200660849](#) [1200661295](#) [1200661297](#)
[1200661342](#) [1200661343](#) [1200670080](#) [1200670220](#) [1200680331](#) [1200720252](#) [1200730184](#) [1200860344](#) [1200870359](#) [1200870643](#)
[1200980008](#) [1200980031](#) [1210502211](#)