

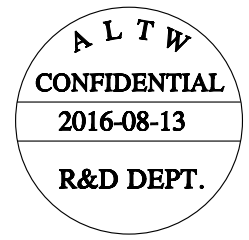

REV.	ECN NO.	DATE	SIGN	DESCRIPTION
B	LEN1580166-177	2015/08/10	Feng_Li	Add Black PVC Cable
C	LEN1680686-703	2016/08/13	Yulong_wang	Add 6Pin & IP69K.

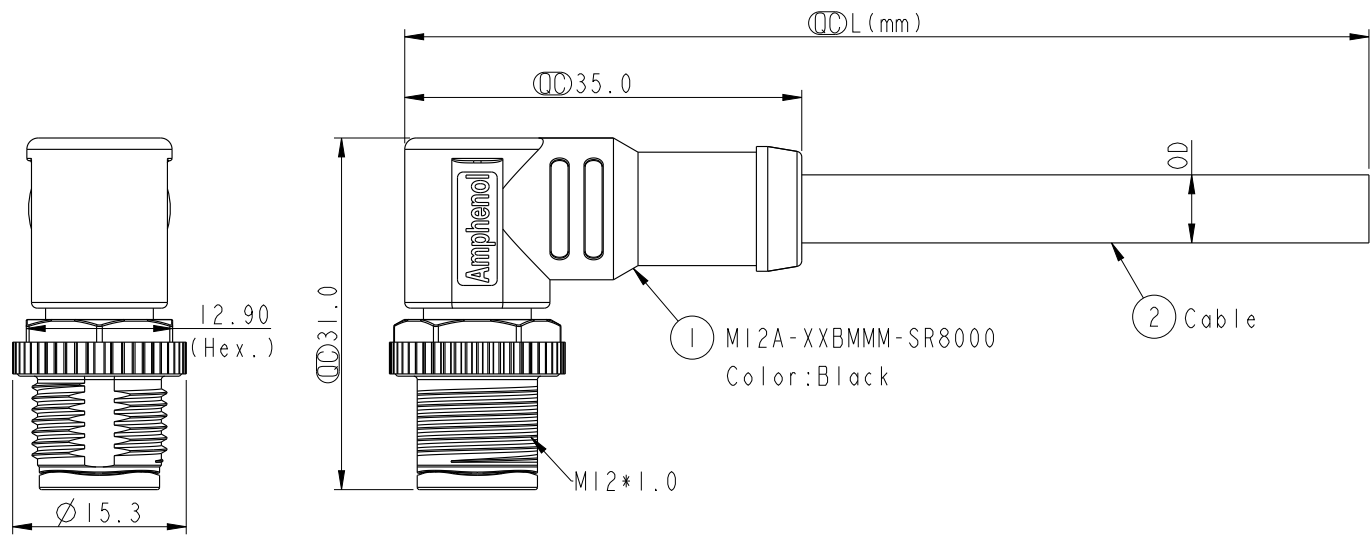

- Notes:
- * \varnothing Important Dimension.
 - $\triangle C$ * Waterproof Rate: IP68, IP69K.
 - * Connector: PU+GF, Black.
 - * Male Pin: Copper Alloy, Gold Plated.
 - * Screw Nut: Zinc Alloy, Nickel Plated.
 - * Outer Mold: PU, Black.
 - $\triangle B$ * Cable: (A) UL2517, PVC Jacket, Yellow.
(B) UL20549, PUR Jacket, Black.
(D) UL2517, PVC Jacket, Black.
 - * Rated Voltage: 3 & 4Pin 250V dc. or ac.
5Pin 60V dc. or ac.
6~12Pin 30V dc. or ac.
 - * Rated Current: 3~5Pin 4A
6~8Pin 2A
10~12Pin 1.5A
 - * Operating Temperature: -25~85°C
 - * Cable Length Tolerance: 01M:±40mm
02M~05M:±60mm
06M~10M:±100mm
11M~30M:±200mm

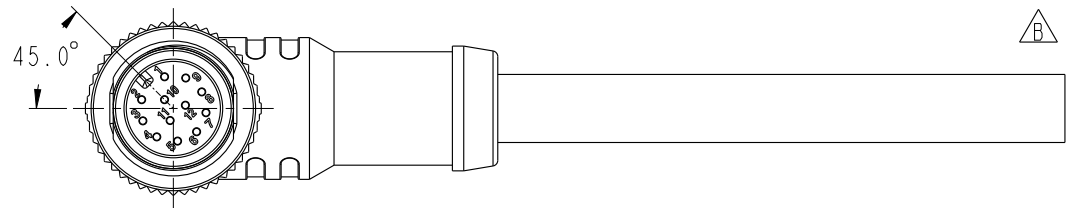

UNIT:mm  
TOLERANCE
±0.5mm

TITLE M12 A Type 90° Male Conn.			
SCALE 3:2	SIZE A4	SHEET 1 OF 3	
REV. C	WC-REV. A.1	\varnothing : Inspection item	

Amphenol LTW
安費諾亮泰企業股份有限公司

ITEM NO	DRAWN BY Yulong_wang	DATE 2016-08-13
DWG NO M12A-XXBMMM-SR8XXX	CHECKED BY Jinhai	DATE 2016-08-13
CUSTOMER ALTW	APPROVED BY Jerry	DATE 2016-08-13

THIS DOCUMENT IS SUBJECT TO CHANGE WITHOUT NOTICE. IT IS CONFIDENTIAL AND A PROPERTY OF Amphenol LTW. DISCLOSURE TO THIRD PARTY HAS TO BE AUTHORIZED BY Amphenol LTW.

F
E
D
C
B
A

ALTW
CONFIDENTIAL
 2016-08-13
R&D DEPT.

Contacts	Cable Jacket	Cable OD	AWG	Item No.	
△B	PVC	12P	6.0	26	M12A-12BMMM-SR8DXX
		10P			M12A-10BMMM-SR8DXX
△C	PVC	8P	5.5	24	M12A-08BMMM-SR8DXX
		6P	5.0		M12A-06BMMM-SR8DXX
	PUR	5P	5.1		M12A-05BMMM-SR8DXX
		4P	4.8	22	M12A-04BMMM-SR8DXX
	PVC	3P	4.5		M12A-03BMMM-SR8DXX
		12P	6.0	26	M12A-12BMMM-SR8BXX
△C	PUR	10P			M12A-10BMMM-SR8BXX
		8P	5.5	24	M12A-08BMMM-SR8BXX
	PUR	6P	5.0		M12A-06BMMM-SR8BXX
		5P	5.1		M12A-05BMMM-SR8BXX
	PVC	4P	4.8	22	M12A-04BMMM-SR8BXX
		3P	4.5		M12A-03BMMM-SR8BXX
△C	PVC	12P	6.0	26	M12A-12BMMM-SR8AXX
		10P			M12A-10BMMM-SR8AXX
	PUR	8P	5.5	24	M12A-08BMMM-SR8AXX
		6P	5.0		M12A-06BMMM-SR8AXX
	PVC	5P	5.1		M12A-05BMMM-SR8AXX
		4P	4.8	22	M12A-04BMMM-SR8AXX
	PVC	3P	4.5		M12A-03BMMM-SR8AXX

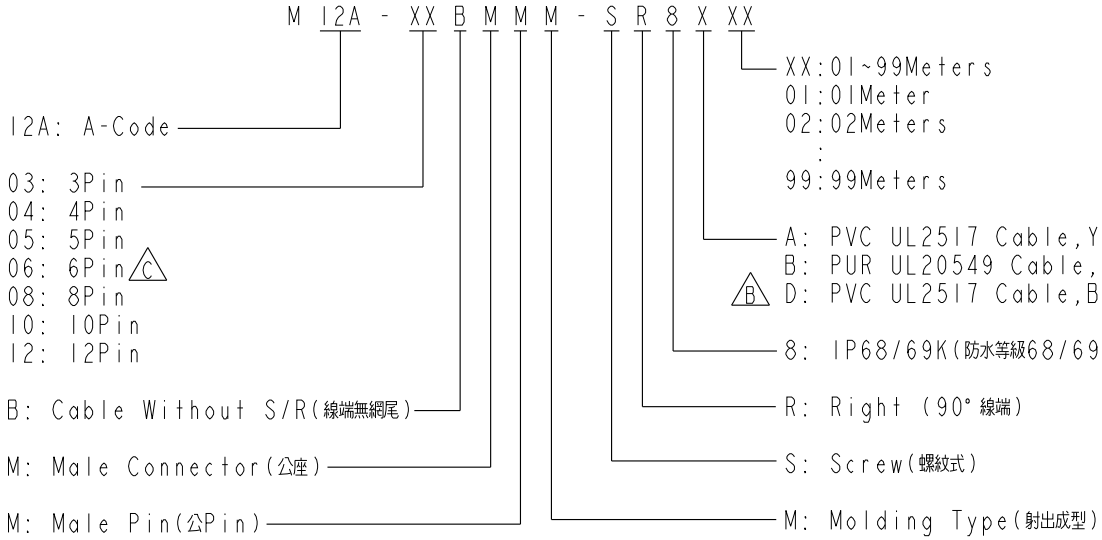

UNIT: mm		
TOLERANCE		
±0.5mm		

TITLE M12 A Type 90° Male Conn.			
SCALE 3:2	SIZE A4	SHEET 2 OF 3	
REV. C	WC-REV. A.1	QC: Inspection item	

Amphenol LTW
安費諾亮泰企業股份有限公司

ITEM NO	DRAWN BY Yulong_wang	DATE 2016-08-13
DWG NO M12A-XXBMMM-SR8XXX	CHECKED BY Jinhai	DATE 2016-08-13
CUSTOMER ALTW	APPROVED BY Jerry	DATE 2016-08-13

THIS DOCUMENT IS SUBJECT TO CHANGE WITHOUT NOTICE. IT IS CONFIDENTIAL AND A PROPERTY OF Amphenol LTW. DISCLOSURE TO THIRD PARTY HAS TO BE AUTHORIZED BY Amphenol LTW.

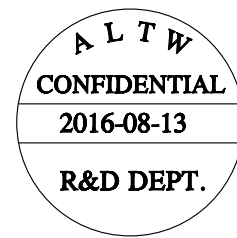

5	--		5	--		5	Gray	灰	5	--		8	--		8	Red	紅	12	--	12	Red/Blue	紅/藍
4	Black	黑	4	Black	黑	4	Black	黑	4	Black	黑	7	Blue	藍	7	Blue	藍	11	--	11	Gray/Pink	灰/粉
3	Blue	藍	3	Blue	藍	3	Blue	藍	3	Blue	藍	6	Pink	粉	6	Pink	粉	10	Violet	10	Violet	紫
2	--		2	White	白	2	White	白	2	White	白	5	--		5	Gray	灰	9	Black	9	Black	黑
1	Brown	棕	1	Brown	棕	1	Brown	棕	1	Brown	棕	4	Yellow	黃	4	Yellow	黃	8	Red	8	Red	紅
												3	Green	綠	3	Green	綠	7	Blue	7	Blue	藍
												2	Brown	棕	2	Brown	棕	6	Pink	6	Pink	粉
												1	White	白	1	White	白	5	Gray	5	Gray	灰
																		4	Yellow	4	Yellow	黃
																		3	Green	3	Green	綠
																		2	Brown	2	Brown	棕
																		1	White	1	White	白

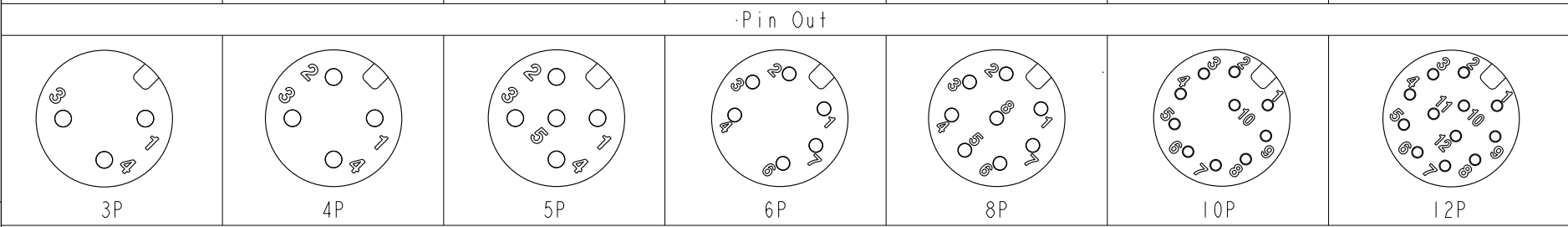

Pin Assignments Front View

UNIT:mm TOLERANCE ±0.5mm		TITLE M12 A Type 90° Male Conn.			<h2 style="margin: 0;">Amphenol LTW</h2> 安費諾亮泰企業股份有限公司		ITEM NO M12A-XXBMMM-SR8XXX	DRAWN BY Yulong_wang	DATE 2016-08-13
		SCALE 3:2	SIZE A4	SHEET 3 OF 3		CHECKED BY Jinhai	DATE 2016-08-13		
		REV. C	WC-REV. A.1	(CC): Inspection item		APPROVED BY Jerry	DATE 2016-08-13		

X-ON Electronics

Largest Supplier of Electrical and Electronic Components

Click to view similar products for [Sensor Cables / Actuator Cables](#) category:

Click to view products by [Amphenol](#) manufacturer:

Other Similar products are found below :

[60963](#) [60964](#) [703000D02F2002](#) [703001D02F0602](#) [703001D02F300](#) [704000D02F120](#) [773032K02F030](#) [802027107404-1](#) [802027213811-1](#)
[804001A09M150](#) [805001A09M0502](#) [84914-0235](#) [84914-0237](#) [885030A09M020](#) [8R4J30E03C3003](#) [1200651332](#) [1200651713](#) [1200660844](#)
[1200660845](#) [1200661173](#) [1200680071](#) [1200720053](#) [1200720081](#) [1200720099](#) [1200720217](#) [1200800231](#) [1200860125](#) [1200870123](#)
[1200980102](#) [1200650267](#) [1200650298](#) [1200660183](#) [1200660782](#) [1200660849](#) [1200661295](#) [1200661297](#) [1200661342](#) [1200661343](#)
[1200670080](#) [1200670220](#) [1200680331](#) [1200720252](#) [1200730184](#) [1200860344](#) [1200870359](#) [1200870643](#) [1200980008](#) [1200980031](#)
[1210502211](#) [1210400542](#)