

THIS DOCUMENT IS SUBJECT TO CHANGE WITHOUT NOTICE. IT IS CONFIDENTIAL AND A PROPERTY OF Amphenol LTW. DISCLOSURE TO THIRD PARTY HAS TO BE AUTHORIZED BY Amphenol LTW.

REV.	ECN NO.	DATE	SIGN	DESCRIPTION
B	LENI580037-038	2015/07/26	Yulong_wang	Change to Share Drawing.
C	LENI690060-061	2016/09/05	Yulong_wang	Add 3, 4 Pin & IP69K.

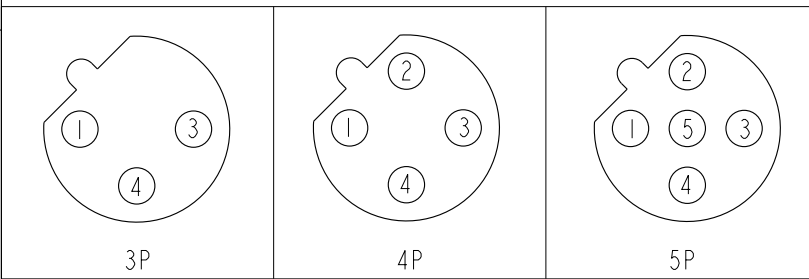

Pin Assignment Front View

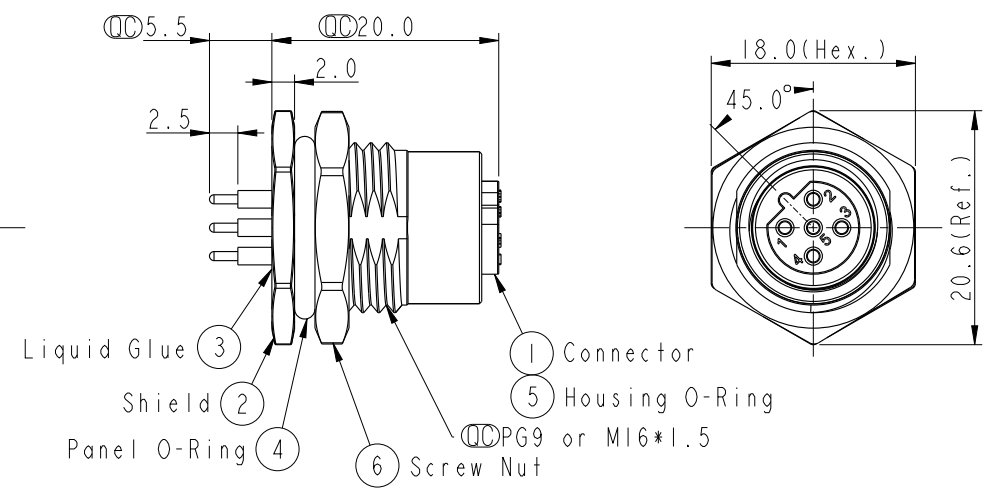
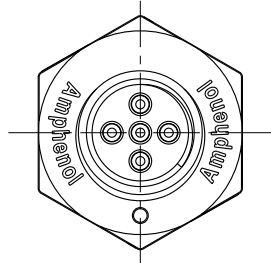
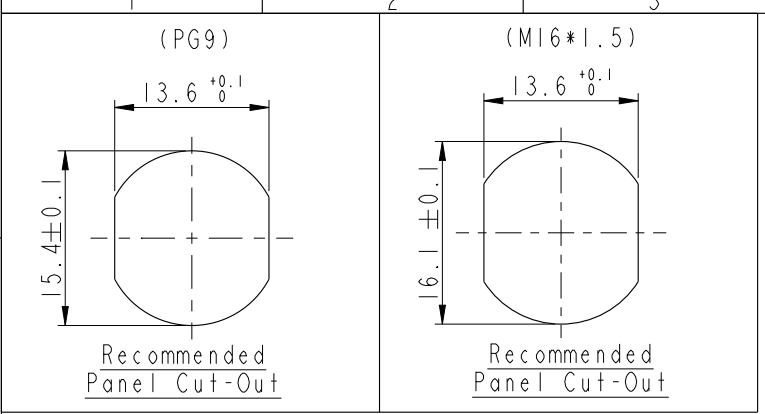
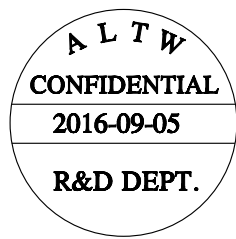

- Note:
- * \varnothing Important Dimension.
 - * Waterproof Rate: IP68, IP69K.
 - * Housing: Nylon+GF, Black.
 - * Female Pin: Copper Alloy, Gold Plated.
 - * Shield: Zinc Alloy, Nickel Plated.
 - * Screw Nut: Zinc Alloy, Nickel Plated.
 - * Panel O-Ring: Viton, Black.
 - * Housing O-Ring: Viton, Green.
 - * Rated Voltage: 3 & 4Pin 250V dc. or ac.
5Pin 60V dc. or ac.
 - * Rated Current: 4A
 - * Operating Temperature: -40~+105°C
 - * For Panel Thickness Max 4.5mm.
 - * Recommended Nut Torque: 4-6 Kgf.cm.

UNIT: mm			TITLE M12 B-Code Female Conn. PCB Type Unshielded
TOLERANCE .X ±0.25 .XX ±0.1 .XXX ±0.05 ANGLES ±1°	SCALE 3:2	SIZE A4	SHEET 1 OF 2
REV. C	WC-REV. A.5	\varnothing : Inspection item	

Amphenol LTW
安費諾亮泰企業股份有限公司

ITEM NO.	DRAWN BY Yulong_wang	DATE 2016-09-05
DWG NO. M12B-XXPFFP-SF8XXX	CHECKED BY Jinhai	DATE 2016-09-05
CUSTOMER ALTW	APPROVED BY Jerry	DATE 2016-09-05

THIS DOCUMENT IS SUBJECT TO CHANGE WITHOUT NOTICE. IT IS CONFIDENTIAL AND A PROPERTY OF Amphenol LTW. DISCLOSURE TO THIRD PARTY HAS TO BE AUTHORIZED BY Amphenol LTW.

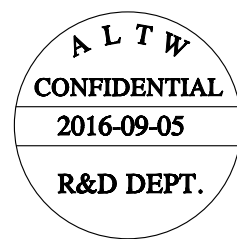

1 2 3 4 5 6 7 8

F
E
D
C
B
A

M 12B - XX P F F P - S F 8 XXX

12B: B-Code
 03: 3Pin
 04: 4Pin
 05: 5Pin

P: Panel (板端)
 F: Female Connector (母座)
 F: Female Pin (母Pin)

001: PG9
 002: M16*1.5
 8: IP68/69K (防水等級68/69K)

F: Front Fasten (前鎖式/Enclosure Rear Mount)
 S: Screw (螺紋式)
 P: PCB THT/DIP Type (180° 基板插件式)

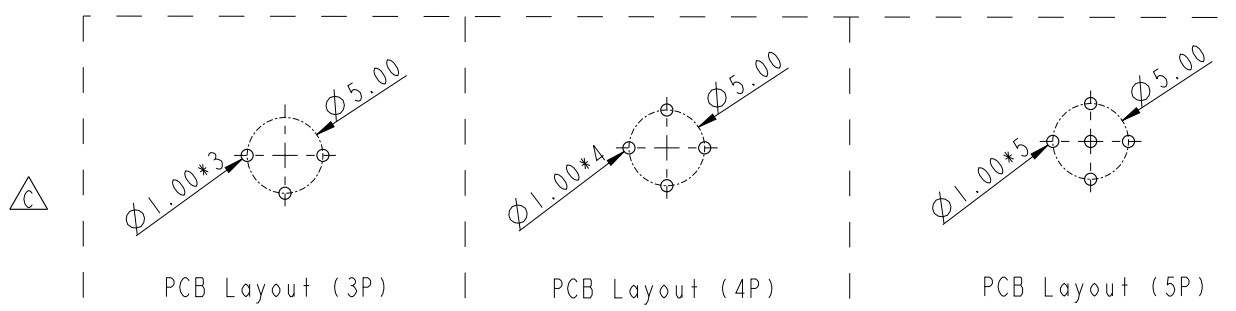

UNIT: mm		
TOLERANCE	.X	±0.25
	.XX	±0.1
	.XXX	±0.05
ANGLES		±1°

TITLE M12 B-Code Female Conn. PCB Type Unshielded		
SCALE 3:2	SIZE A4	SHEET 2 OF 2
REV. C	WC-REV. A.4	: Inspection item

Amphenol LTW
 安費諾亮泰企業股份有限公司

ITEM NO	DRAWN BY Yulong_wang	DATE 2016-09-05
DWG NO M12B-XXPFFP-SF8XXX	CHECKED BY Jinhai	DATE 2016-09-05
CUSTOMER ALTW	APPROVED BY Jerry	DATE 2016-09-05

DATE 2016-09-05
DATE 2016-09-05
DATE 2016-09-05

2 3 4 5 6 7 8 FMW10702-01-02A1

X-ON Electronics

Largest Supplier of Electrical and Electronic Components

Click to view similar products for [Sensor Cables / Actuator Cables](#) category:

Click to view products by [Amphenol](#) manufacturer:

Other Similar products are found below :

[60963](#) [60964](#) [M83513/19-F01CP](#) [703000D02F2002](#) [703001D02F0602](#) [703001D02F300](#) [704000D02F120](#) [773032K02F030](#) [802027107404-1](#)
[802027213811-1](#) [804001A09M150](#) [805001A09M0502](#) [84914-0235](#) [84914-0237](#) [885030A09M020](#) [8R4J30E03C3003](#) [1200651332](#)
[1200651713](#) [1200660844](#) [1200660845](#) [1200661173](#) [1200680071](#) [1200720053](#) [1200720081](#) [1200720099](#) [1200720217](#) [1200800231](#)
[1200860125](#) [1200870123](#) [1200980102](#) [1200650267](#) [1200650298](#) [1200660183](#) [1200660782](#) [1200660849](#) [1200661295](#) [1200661297](#)
[1200661342](#) [1200661343](#) [1200670080](#) [1200670220](#) [1200680331](#) [1200720252](#) [1200730184](#) [1200860344](#) [1200870359](#) [1200870643](#)
[1200980008](#) [1200980031](#) [1210502211](#)