

THIS DOCUMENT IS SUBJECT TO CHANGE WITHOUT NOTICE. IT IS CONFIDENTIAL AND A PROPERTY OF Amphenol LTW. DISCLOSURE TO THIRD PARTY HAS TO BE AUTHORIZED BY Amphenol LTW.

REV.	ECN NO.	DATE	SIGN	DESCRIPTION
A		2022-01-20	Jiahe Lin	Rev.01 To Rev.A

M12D-XXPMMR-EE0001  
 XX: No. Of Pin

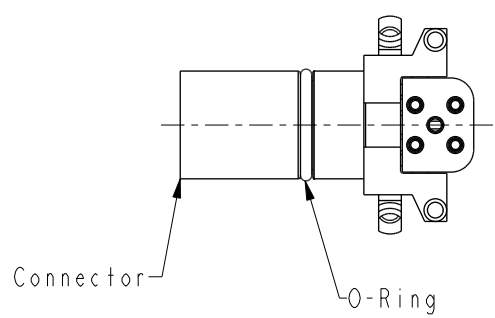
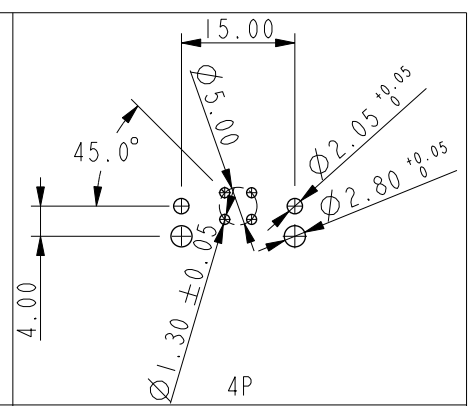
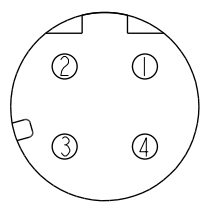
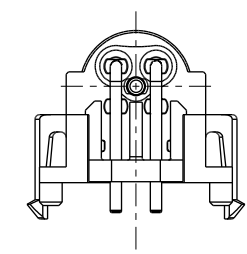
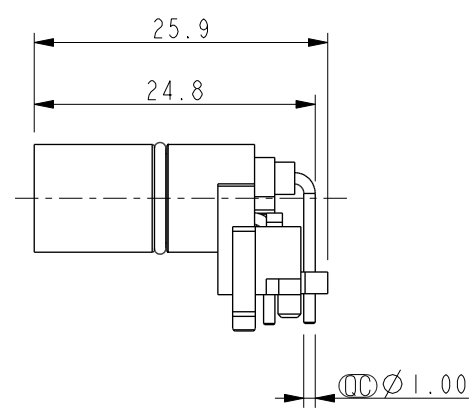
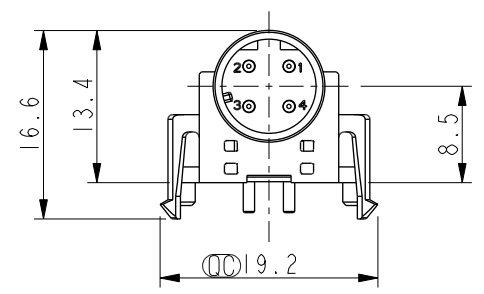
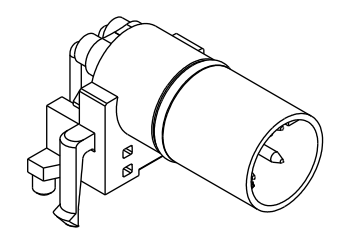
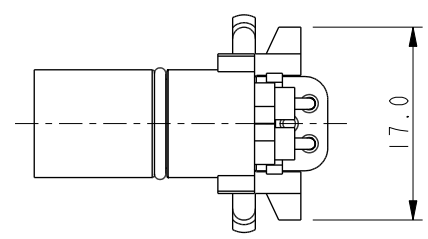

Note:  
 \* RoHS Compliant  
 \*  $\varnothing$  Important dimension  
 \* Waterproof rate: Non-Waterproof  
 \* Connector  
 Housing: Thermoplastic, Black  
 Pin: Copper alloy, Gold plated  
 O-Ring: Rubber, Black  
 \* For pcb thickness max: 1.6mm

Pin Assignment  
Front View

Recommended PCB Layout

UNIT:mm		
TOLERANCE	.X ±0.25	
.XX ±0.1		
.XXX ±0.05		
ANGLES	±1°	

TITLE N SEN, M12 D, RECEPTACLE, M, M, PCB R		
SCALE 3:2	SIZE A4	SHEET 1 OF 1
REV. A	WC-REV. A.1	$\varnothing$ : Inspection item

**Amphenol LTW**  
 安費諾亮泰企業股份有限公司

ITEM NO	DRAWN BY Jiahe Lin	DATE 2022-01-20
DWG NO M12D-XXPMMR-EE0001	CHECKED BY Allen Pan	DATE 2022-01-20
CUSTOMER ALTW	APPROVED BY Fred Lee	DATE 2022-01-20

## X-ON Electronics

Largest Supplier of Electrical and Electronic Components

*Click to view similar products for [Circular Metric Connectors](#) category:*

*Click to view products by [Amphenol](#) manufacturer:*

Other Similar products are found below :

[600X518037X](#) [MA1EAF1200](#) [6STD15PCR99B70A](#) [8R4000A16M020](#) [8R4A00A18M020](#) [8R5000A16M005](#) [1200910008](#) [1200910011](#)  
[1300140094](#) [130203-0054](#) [1300150099](#) [RF-12S1N8A90DU](#) [1-3637-600-5205](#) [1612618](#) [8R4006A16M010](#) [8R5006A18A120](#) [1604232](#)  
[1R3006A20M005](#) [RF-12P1N8A80DU](#) [RF-12P1N8A90DU](#) [41-01016](#) [41-40011](#) [41-40017](#) [42-01015](#) [4-22279-4](#) [4-22281-1](#) [4-22284-9](#) [43-](#)  
[00002](#) [43-01166](#) [41-40005](#) [41-40016](#) [43-00161](#) [43-01191](#) [XS3P-M421-2](#) [600X518050X](#) [SACC-DSI-FS-5P-PG9-L180 SC](#) [8R4006A16A120](#)  
[8R4000A16M010](#) [RKC 50/16](#) [1R3004A20A1201](#) [6-22279-3](#) [N03FA03144](#) [1300140077](#) [XS8A-0441](#) [859RD04-103R004](#) [860RD04-113R004](#)  
[860RD04-213R004](#) [860-X08-213R004](#) [1-213245-2](#) [2273142-2](#)