

# Amphenol® Low Mating Force Rectangular Connectors

12-035-12

[www.amphenol-aerospace.com](http://www.amphenol-aerospace.com)

Visit our website and see the very broad range of cylindrical and rectangular interconnection products from Amphenol Aerospace.

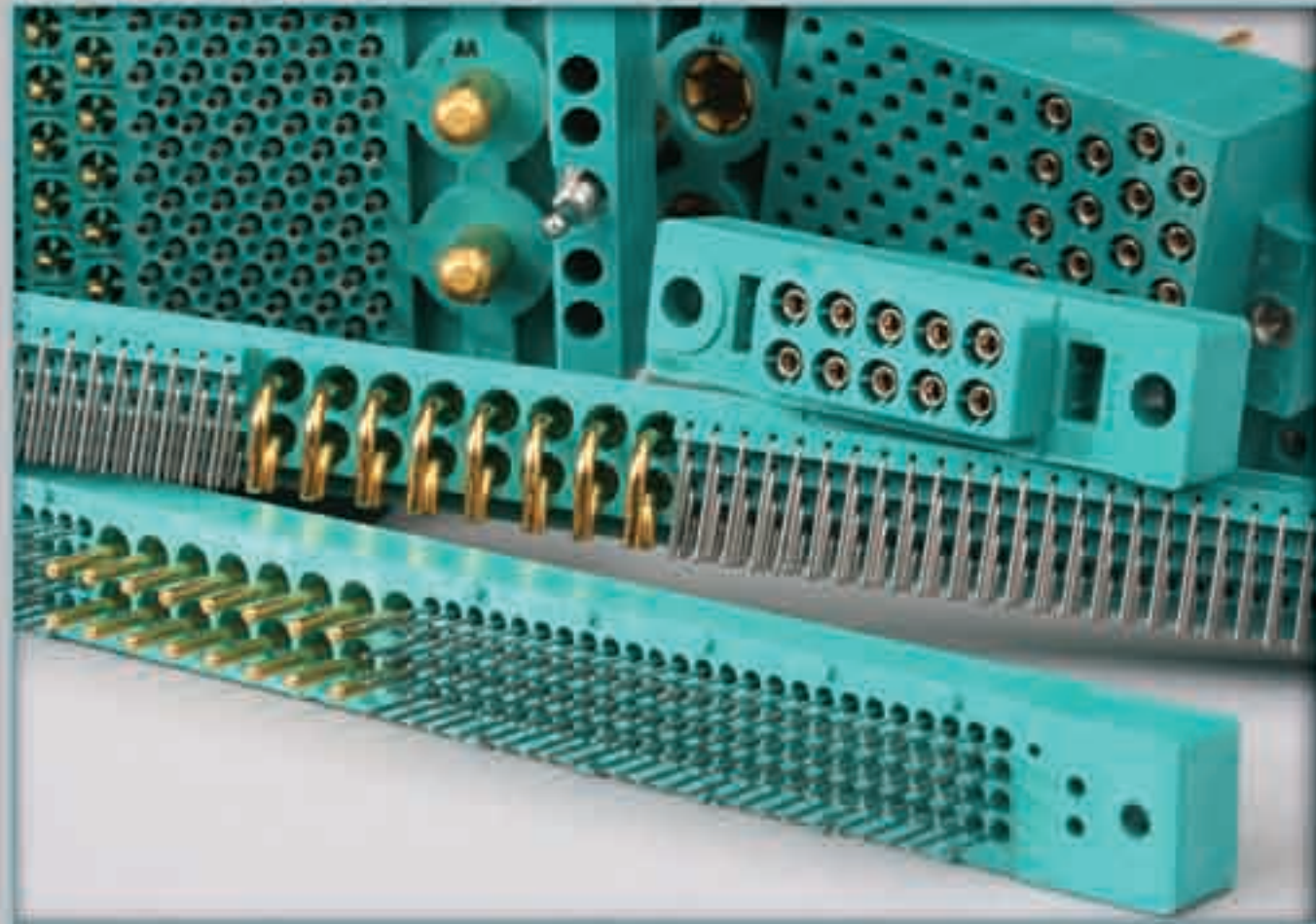

## MIL-DTL-55302 BRUSH CONTACT TECHNOLOGY



Amphenol® Bristle Brush Contact:  
Multiple Strands of High Tensile Strength  
Wires Bundled Together, Providing Superior  
Electrical Connection with Low Mating Force

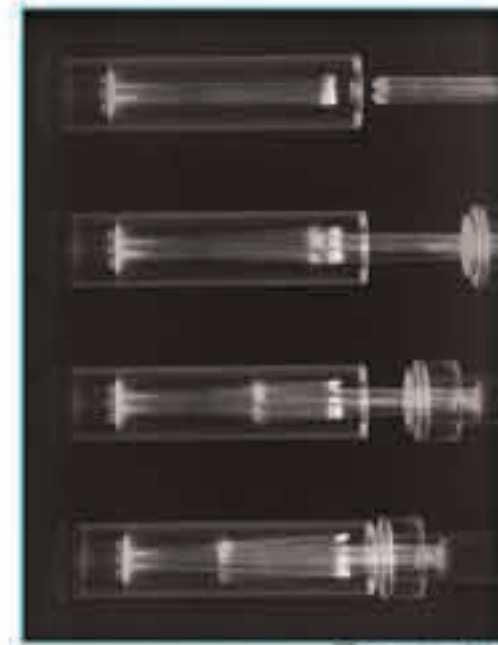

Amphenol's Broad Family  
of Low Mating Force  
Interconnect Products  
with Brush Contacts



*Design Flexibility -  
Combination of Brush  
Contacts and Fiber  
Optic Termini*



*Combination of Brush  
Contacts, Coax and  
Power Contacts*



*Power Strip Connector  
Series with cavities for  
size 16 or 12 power  
contacts (or size 16 or  
12 coax contacts).*

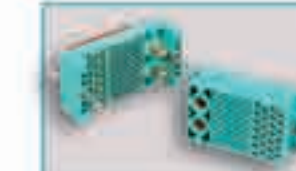

*Hybrid Custom  
Connector with Brush  
Contacts and  
Power Contacts*



*Docking Connectors -  
The Brush Contact  
offers high performance  
where frequent docking  
to charge and transfer  
data is a necessity.*

The Bristle Brush contact has been proven in military avionics packages and meets the requirements of MIL-DTL-55302. It provides high density in tighter spacing, low mating/unmating forces, proven durability and long contact life. Applications for Amphenol® Connectors with Brush contacts include:

- Medical equipment
- IC chip testers
- Telecommunications
- Military and Commercial Aviation
- Military Ground Vehicles
- GPS systems

### Other Similar Rectangular Connectors from Amphenol

For more information, see additional Amphenol Rectangular Products at the end of this catalog.



*High Density  
HDB<sup>®</sup> and HSB<sup>®</sup> Series*



*LRM (Line Replaceable Module)  
Interconnects*



*Ruggedized  
Brush Rack & Panel  
Connectors*



*Ruggedized  
VME64x Interconnects*



*High Speed LRM  
Gigastak &  
Digastak Inserts*

Amphenol Corporation  
**Amphenol Aerospace Operations**  
40-60 Delaware Avenue, Sidney, New York 13838-1395  
Phone: 800-678-0141 or 607-563-5011 Fax: 607-563-5157  
[www.amphenol-aerospace.com](http://www.amphenol-aerospace.com)

**Amphenol  
Aerospace**

# Amphenol® Low Mating Force Rectangular Connectors

12-035-12

[www.amphenol-aerospace.com](http://www.amphenol-aerospace.com)

Visit our website and see the very broad range of cylindrical and rectangular interconnection products from Amphenol Aerospace.

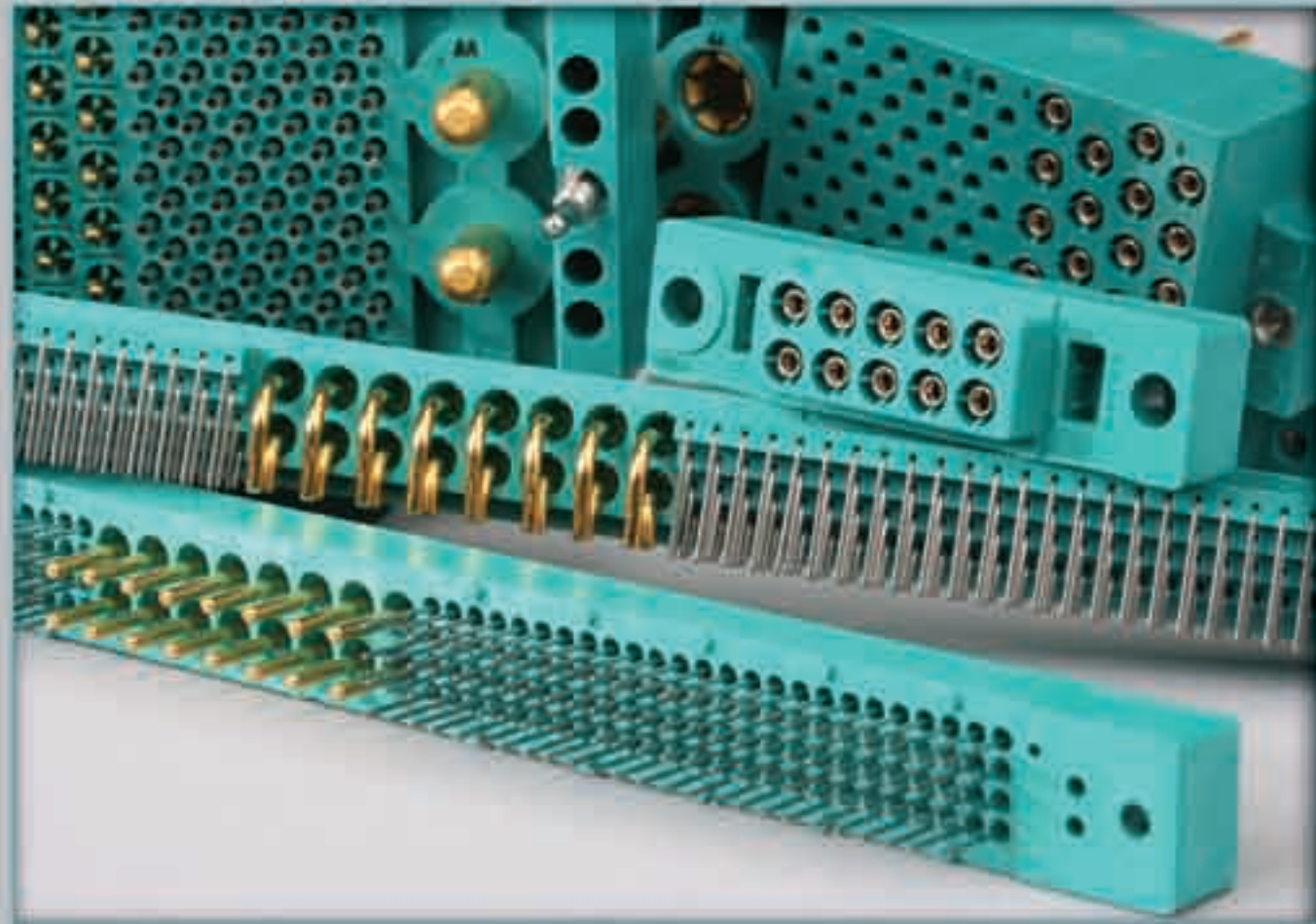

## MIL-DTL-55302 BRUSH CONTACT TECHNOLOGY



Amphenol® Bristle Brush Contact:  
Multiple Strands of High Tensile Strength  
Wires Bundled Together, Providing Superior  
Electrical Connection with Low Mating Force

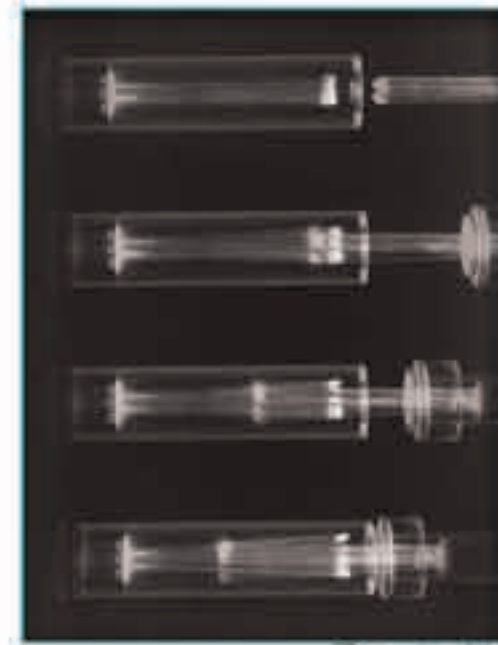

Amphenol's Broad Family  
of Low Mating Force  
Interconnect Products  
with Brush Contacts



*Design Flexibility -  
Combination of Brush  
Contacts and Fiber  
Optic Termini*



*Combination of Brush  
Contacts, Coax and  
Power Contacts*



*Power Strip Connector  
Series with cavities for  
size 16 or 12 power  
contacts (or size 16 or  
12 coax contacts).*



*Hybrid Custom  
Connector with Brush  
Contacts and  
Power Contacts*



*Docking Connectors -  
The Brush Contact  
offers high performance  
where frequent docking  
to charge and transfer  
data is a necessity.*

The Bristle Brush contact has been proven in military avionics packages and meets the requirements of MIL-DTL-55302. It provides high density in tighter spacing, low mating/unmating forces, proven durability and long contact life. Applications for Amphenol® Connectors with Brush contacts include:

- Medical equipment
- IC chip testers
- Telecommunications
- Military and Commercial Aviation
- Military Ground Vehicles
- GPS systems

### Other Similar Rectangular Connectors from Amphenol

For more information, see additional Amphenol Rectangular Products at the end of this catalog.



*High Density  
HDB® and HSB® Series*



*LRM (Line Replaceable Module)  
Interconnects*



*Ruggedized  
Brush Rack & Panel  
Connectors*



*Ruggedized  
VME64x Interconnects*



*High Speed LRM  
Gigastak &  
Digastak Inserts*

Amphenol Corporation  
**Amphenol Aerospace Operations**  
40-60 Delaware Avenue, Sidney, New York 13838-1395  
Phone: 800-678-0141 or 607-563-5011 Fax: 607-563-5157  
[www.amphenol-aerospace.com](http://www.amphenol-aerospace.com)

**Amphenol**  
Aerospace

## Brush vs. Conventional Contacts

### Brush Contact Innovation

- Multiple contact interfaces - Strands of high tensile wire are bundled together to form brush-like contacts. By inter-meshing two multi-strand wire bundles, an electrical connection is made.
- Provides redundant current paths, 14-70 (points of contact) per mated contact with a gas tight junction
- Very smooth (low friction) interface

### Conventional Pin/Socket

- Machined surface finish on both parts
- Higher friction and wear
- Limited number of contact sites

## Amphenol's High Technology Machining and Computer Driven Centers for Connector and Contact Production

Amphenol Aerospace, located in upstate New York USA, has diverse manufacturing capability including state of the art CNC machining, die-casting, molding, impact and extruding, screw machining and plating.

Also within this facility are complete design engineering and environmental test facilities. High technology production centers at the Amphenol home facility and its satellite facilities create volume runs that are cost effective and meet on-time delivery demands.

Amphenol operates a Quality System that is third-party certified to ISO-9001:2008 and AS9100.

For more information on Amphenol Aerospace capabilities in Rectangular products, or any other of the wide range of connector products, please contact us:  
Amphenol Aerospace Operations  
40-60 Delaware Avenue  
Sidney, NY 13838-1395  
Phone: 800-678-0141 or 607-563-5011

[www.amphenol-aerospace.com](http://www.amphenol-aerospace.com)



High Technology Machine Center

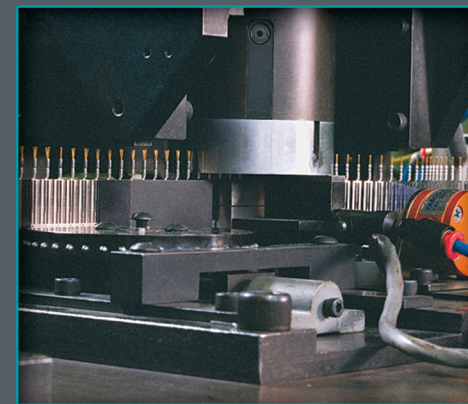

Brush Contact Machining

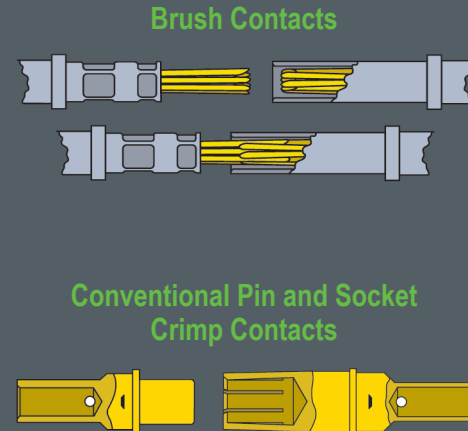

Brush Contacts

Conventional Pin and Socket Crimp Contacts

## Bristle Brush Contacts

- High density in tighter spacing - a main concern for integrated electronics.
- A superior choice for board level interconnects.

## Table of Contents

Low Mating Force Rectangular Connectors with Brush Contacts Features, Performance, Materials . . . . .	1
Selecting the Correct Mated Connection, Four Body Styles . . . . .	2
How to Order Military and Commercial . . . . .	3-5
Connector Row and Cavity Identification, Contact Arrangements 2 Row . . . . .	6
Contact Arrangements 3 and 4 Row . . . . .	7
Mother Board Connector . . . . .	8-11
Daughter Board Connector . . . . .	12-15
Input/Output Connector . . . . .	16-19
PC Connector . . . . .	20-23
Accessories, Polarization Keys . . . . .	24
Accessories, Test Probe Kit . . . . .	25
Connector Installation/User Application Information . . . . .	26-29
Smaller Sized Brush Connectors - Design Flexibility . . . . .	30, 31
Hybrid Configurations with Contact Options . . . . .	32
Hybrid Designs, Small Color-Coded Brush Connectors . . . . .	33
Other Brush Contact Rectangular Connectors:	
Docking Connectors . . . . .	34
HDB <sup>3</sup> High Density Brush Connectors. . . . .	35
HSB <sup>3</sup> High Density Brush Connectors. . . . .	36
Ruggedized Rack and Panel Connectors . . . . .	37
LRM (Line Replaceable Module) Connectors . . . . .	38
LRM Hybrids and High Speed LRM Gigastak & Digastak . . . . .	39
Other Rectangular Connectors:	
Total Packaging with Amphenol Printed Circuit Boards, Rectangular and Cylindrical Connectors . . . . .	40
Amphenol Sales Office and Distributor Listing . . . . .	Inside Back

Please note that, in the future, this catalog will be part of Amphenol's New Combined Rectangular Interconnect Catalog. Call Amphenol Aerospace for more information about this combined catalog, to be available Jan. 2011.

## Amphenol® B<sup>3</sup> Bristle® Brush® Contact Advantages:



### Low Mating & Unmating Forces

- Smooth, low friction interfaces
- 70% to 90% reduction in mating/unmating forces from conventional pin-socket contacts
- 1.5 oz. maximum forces per contact pair (one ounce typical)
- Easy mating/unmating makes high circuit counts practical (25 lbs. typical for 400 contacts)
- Mechanical mating aids not required
- No need for external board support structures for connectors up to 7 inches long. A center support is recommended for Mother Board Connectors over 7 inches.

### Proven Durability and Long Contact Life

- 100,000 mating cycles, even when hot swapped
- Documented intermittency free performance – no 10 nano second discontinuities during 50m cycles of 0.010 displacement
- Overall cost effectiveness (reduced life cycle costs)

### Multiple Points of Contact Provide Superior Electrical Capability

- 14-70 points of contact per mated contact
- Stable, low resistance – 20 milliohms max.
- Redundant current paths results in lower total resistance
- Proven electrical and gas tight contact sites

## Amphenol Corporation Amphenol Aerospace Amphenol Industrial Operations

**Amphenol Commercial Air**  
40-60 Delaware Avenue,  
Sidney, NY 13838-1395  
Phone: 607-563-5011  
1-800-678-0141  
Fax: 607-563-5157  
[www.amphenol-aerospace.com](http://www.amphenol-aerospace.com)  
[www.amphenol-industrial.com](http://www.amphenol-industrial.com)

Amphenol Corporation  
**Amphenol Aerospace**  
2010 Corporate Ridge  
McLean, VA 22101  
Phone: 1-800-678-0141

OTHER AMPHENOL DIVISIONS  
**Amphenol Backplane Systems**  
18 Celina Avenue  
Nashua, NH 03063  
Phone: 888-318-3553  
Fax: 603-883-0171  
Web: [www.amphenol.abs.com](http://www.amphenol.abs.com)

**Amphenol Canada**  
605 Milner Ave.  
Toronto, Ontario M1B 5X6  
Phone: 416-291-4401  
Fax: 416-292-0647  
Web: [www.amphenolcanada.com](http://www.amphenolcanada.com)

**Amphenol PCD**  
72 Cherry Hill Drive  
Beverly, MA 01915  
Phone: 978-624-3400  
Fax: 978-927-1513  
Web: [www.amphenolpcd.com](http://www.amphenolpcd.com)  
E-mail: [milaero@amphenolpcd.com](mailto:milaero@amphenolpcd.com)

**Amphenol Printed Circuits**  
91 Northeastern Boulevard  
Nashua, NH 03062  
Phone: 603-324-4500  
Fax: 603-324-4717  
Web: [www.amphenol-tcs.com](http://www.amphenol-tcs.com)

**SV Microwave**  
RF Connectors & Components,  
an Amphenol Company  
2400 Centrepark West Drive,  
Suite 100  
West Palm Beach, FL 33409  
Phone: 561-840-1800  
Fax: 561-844-8551  
E-mail: [sales@svmicro.com](mailto:sales@svmicro.com)  
Web: [www.svmicrowave.com](http://www.svmicrowave.com)

**Amphenol Nexus**  
50 Sunnyside Avenue  
P.O. Box 10177  
Stamford, CT 06904-2177  
Phone: 203-327-7300  
Fax: 203-324-7623  
E-mail: [salesinfo@nexus.com](mailto:salesinfo@nexus.com)  
Web: [www.nexus.com](http://www.nexus.com)

## AUTHORIZED DISTRIBUTORS Corporate Headquarters Alphabetical Listing

**ARROW ELECTRONICS**  
7459 S. Lima Street  
Englewood, CO 80112-5816  
Phone: 800-833-3557  
Fax: 800-562-3542  
Web: [www.arrow.com](http://www.arrow.com)

**AVNET**  
2211 47th Street  
Phoenix, AZ 85034  
Phone: 800-332-8638  
Web: [www.avnet.com](http://www.avnet.com)

**PEI GENESIS**  
2180 Hornig Road  
Philadelphia, PA 19116  
Phone: 800-523-0727  
Fax: 215-552-8022  
Web: [www.peigenesis.com](http://www.peigenesis.com)

**POWELL ELECTRONICS**  
200 Commodore Drive  
Logan Township, NJ 08085  
Phone: 800-235-7880  
Fax: 215-937-4655  
Web: [www.powell.com](http://www.powell.com)

**TTI INC.**  
2441 Northeast Pkwy.  
Fort Worth, TX 76106  
Phone: 800-225-5884  
Fax: 817-740-9494  
Web: [www.ttiinc.com](http://www.ttiinc.com)

**NEWARK**  
4801 N. Ravenswood  
Chicago, IL 60640-4496  
Phone: 800-463-9275  
Web: [www.newarkinone.com](http://www.newarkinone.com)

## SMALL DISADVANTAGED/ MINORITY DISTRIBUTORS CHEROKEE NATION DISTRIBUTORS

Rt. 3, Box 498  
Stilwell, OK 74960  
Phone: 918-696-3151  
Fax: 918-696-3129  
Web: [www.cherokee-corp.com](http://www.cherokee-corp.com)

**JRH ELECTRONICS LLC**  
11001 Lincoln Drive West  
Marlton, NJ 08053  
Phone: 800-467-8309  
Fax: 609-988-8728  
Web: [www.jrhelec.com](http://www.jrhelec.com)

INTERNATIONAL  
Latin America  
**ARGENTINA**  
Amphenol Argentina  
Avenida Callao 930  
2nd floor Office B Plaza  
C1023AAP Buenos Aires, Argentina  
Phone: (54 11) 48 15 68 86  
Fax: (54 11) 48 14 57 79  
E-mail: [sales@amphenol.com.ar](mailto:sales@amphenol.com.ar)  
Web: [www.bar-tec.com](http://www.bar-tec.com)

**BRAZIL**  
Amphenol do Brasil Ltda.  
Rua Diogo Moreira 132  
20 Ander, Rooms 2001-2-3  
CEP 05423-010  
Sao Paulo - SP, Brazil  
Phone: (55-11) 3815.1003  
Fax: (55-11) 3815.1629  
E-mail: [vendas@amphenol.com.br](mailto:vendas@amphenol.com.br)

**MEXICO**  
Amphenol Mexico  
Prolongacion Reforma 61-6 B2  
Col. Paseo de las Lomas  
C.P. 01330 Mexico D.F., Mexico  
Phone: (52-55) 5258.9984  
Fax: (52-55) 5081.6890  
E-mail: [www@amphenolmexico.com](mailto:www@amphenolmexico.com)

Europe  
**ENGLAND**  
Amphenol Limited  
Thanet Way, Whitstable  
Kent CT5 3JF, United Kingdom  
Phone: (44-1-227) 773200  
Fax: (44-1-227) 276571  
E-mail: [info@amphenol.co.uk](mailto:info@amphenol.co.uk)

**FRANCE**  
Amphenol Socapex  
Promenade de l'Arve, BP29  
Thyze 74311 948 Cedex, France  
Phone: (33-4) 50892800  
Fax: (33-4) 50962975  
Web: [www.amphenol-socapex.com](http://www.amphenol-socapex.com)

**FRANCE**  
Amphenol-Air LB  
29, Voie d'Y Vois  
F-08110 Blagny, France  
Phone: (33-3) 2422-7849  
Fax: (33-3) 2422-1319  
Web: [www.amphenol-airlb.fr](http://www.amphenol-airlb.fr)

**GERMANY**  
Amphenol-Air LB GmbH  
Am Kleinbahnhof 4  
D-66740 Saarlouis, Germany  
Phone: (49-6831) 981-00  
Fax: (49-6831) 9810-30  
Web: [www.amphenol-airlb.com](http://www.amphenol-airlb.com)

**ITALY & REST OF EUROPE**  
Amphenol Italia S.p.A.  
Via Barbaiana 5  
20020 Lainate (Milano), Italy  
Phone: 39-02-932541  
Fax: 39-02-93254444  
E-mail: [info@amphenol-it.com](mailto:info@amphenol-it.com)

Middle East / Africa  
**ISRAEL**  
Bar-Tec Ltd.  
3 Hagavish St., P.O.B. 279  
Kfir-Barkan Bldg., East Industrial Zone  
Kfar Sava 44102, Israel  
Phone: (972-9) 764.4100  
Fax: (972-9) 7674324  
E-mail: [sales@bar-tec.com](mailto:sales@bar-tec.com)  
Web: [www.bar-tec.com](http://www.bar-tec.com)

**SOUTH AFRICA**  
Amphenol South Africa  
30 Impala Road  
2196 Sandton - Chislehurst  
South Africa  
Tel: (27-11) 783-9517  
Fax: (27-11) 783-9519  
E-mail: [amphenol\\_africa@csi.com](mailto:amphenol_africa@csi.com)  
Web: [www.amphenol.co.za](http://www.amphenol.co.za)

**TURKEY**  
Amphenol Turkiye  
Ayazaga Mah. Meydan Sk. No. 28  
Beybi Giz Plaza, Kat. 263496  
Maslak/Istanbul  
Phone: 90 (212) 335 25 01  
Fax: 990 (212) 335 25 00  
E-mail: [saracoglu@amphenol.com.tr](mailto:saracoglu@amphenol.com.tr)  
Web: [www.amphenol.com.tr](http://www.amphenol.com.tr)

Asia / Pacific  
**AUSTRALIA**  
Amphenol Australia LTD  
2 Fiveways Blvd. Keysborough  
Melbourne, Victoria 3173 Australia  
Phone: 613 8796 8888  
Fax: 613 8796 8801  
E-mail: [www@amphenol.com.au](mailto:www@amphenol.com.au)

**RUSSIA**  
Amphenol Russia Office  
8 Yaroslavskaja Str.,  
Floor 2129164 Moscow, Russia  
Phone: 7495 937 6341  
Fax: 7495 937 6319  
E-mail: [russia@amphenol.com](mailto:russia@amphenol.com)

**INDIA**  
Amphenol Interconnect India Pvt, Ltd.  
105 Bhosari Industrial Area  
Pune, 411 026, India  
Phone: (91-20) 27120 462  
Fax: (91-20) 27129 158  
E-mail: [sales@amphenol-in.com](mailto:sales@amphenol-in.com)

**JAPAN**  
Amphenol Japan Mil/Aero & Industrial  
471-1, Deba, Ritto-city  
Shiga 520-3041, Japan  
Phone: 81-77-553-8501  
Fax: 81-77-551-2200

Notice: Specifications are subject to change without notice. Contact your nearest Amphenol Corporation Sales Office for the latest specifications. All statements, information and data given herein are believed to be accurate and reliable but are presented without guarantee, warranty, or responsibility of any kind expressed or implied. Statements or suggestions concerning possible use of our products are made without representation or warranty that any such use is free of patent infringement and are not recommendations to infringe any patent. The user should not assume that all safety measures are indicated or that other measures may not be required. Specifications are typical and may not apply to all connectors.  
©2010 Amphenol Corp. Printed by DP 5/2010

## Brush vs. Conventional Contacts

### Brush Contact Innovation

- Multiple contact interfaces - Strands of high tensile wire are bundled together to form brush-like contacts. By inter-meshing two multi-strand wire bundles, an electrical connection is made.
- Provides redundant current paths, 14-70 (points of contact) per mated contact with a gas tight junction
- Very smooth (low friction) interface

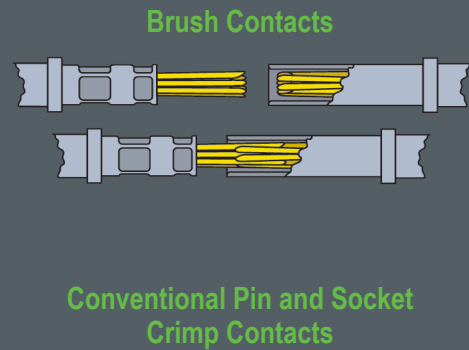

### Conventional Pin/Socket

- Machined surface finish on both parts
- Higher friction and wear
- Limited number of contact sites

## Amphenol's High Technology Machining and Computer Driven Centers for Connector and Contact Production

Amphenol Aerospace, located in upstate New York USA, has diverse manufacturing capability including state of the art CNC machining, die-casting, molding, impact and extruding, screw machining and plating.

Also within this facility are complete design engineering and environmental test facilities. High technology production centers at the Amphenol home facility and its satellite facilities create volume runs that are cost effective and meet on-time delivery demands.



High Technology Machine Center

Amphenol operates a Quality System that is third-party certified to ISO-9001:2008 and AS9100.

For more information on Amphenol Aerospace capabilities in Rectangular products, or any other of the wide range of connector products, please contact us:  
Amphenol Aerospace Operations  
40-60 Delaware Avenue  
Sidney, NY 13838-1395  
Phone: 800-678-0141 or  
607-563-5011

[www.amphenol-aerospace.com](http://www.amphenol-aerospace.com)

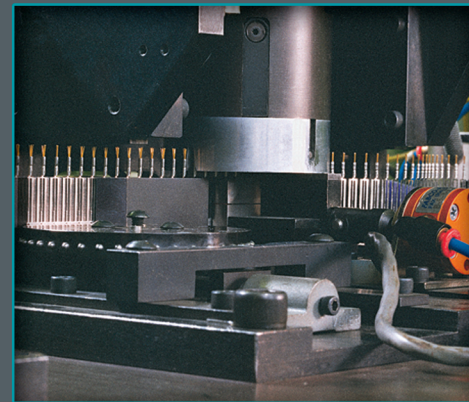

Brush Contact Machining

## Bristle Brush Contacts

- High density in tighter spacing - a main concern for integrated electronics.
- A superior choice for board level interconnects.

## Table of Contents

Low Mating Force Rectangular Connectors with Brush Contacts Features, Performance, Materials . . . . .	1
Selecting the Correct Mated Connection, Four Body Styles . . . . .	2
How to Order Military and Commercial . . . . .	3-5
Connector Row and Cavity Identification, Contact Arrangements 2 Row . . . . .	6
Contact Arrangements 3 and 4 Row . . . . .	7
Mother Board Connector . . . . .	8-11
Daughter Board Connector . . . . .	12-15
Input/Output Connector . . . . .	16-19
PC Connector . . . . .	20-23
Accessories, Polarization Keys . . . . .	24
Accessories, Test Probe Kit . . . . .	25
Connector Installation/User Application Information . . . . .	26-29
Smaller Sized Brush Connectors - Design Flexibility . . . . .	30, 31
Hybrid Configurations with Contact Options . . . . .	32
Hybrid Designs, Small Color-Coded Brush Connectors . . . . .	33
Other Brush Contact Rectangular Connectors:	
Docking Connectors . . . . .	34
HDB <sup>3</sup> High Density Brush Connectors. . . . .	35
HSB <sup>3</sup> High Density Brush Connectors. . . . .	36
Ruggedized Rack and Panel Connectors . . . . .	37
LRM (Line Replaceable Module) Connectors . . . . .	38
LRM Hybrids and High Speed LRM Gigastak & Digastak . . . . .	39
Other Rectangular Connectors:	
Total Packaging with Amphenol Printed Circuit Boards, Rectangular and Cylindrical Connectors. . . . .	40
Amphenol Sales Office and Distributor Listing . . . . .	Inside Back

Please note that, in the future, this catalog will be part of Amphenol's New Combined Rectangular Interconnect Catalog. Call Amphenol Aerospace for more information about this combined catalog, to be available Jan. 2011.

## Amphenol® B<sup>3</sup> Bristle® Brush® Contact Advantages:

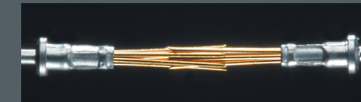

## Low Mating & Unmating Forces

- Smooth, low friction interfaces
- 70% to 90% reduction in mating/unmating forces from conventional pin-socket contacts
- 1.5 oz. maximum forces per contact pair (one ounce typical)
- Easy mating/unmating makes high circuit counts practical (25 lbs. typical for 400 contacts)
- Mechanical mating aids not required
- No need for external board support structures for connectors up to 7 inches long. A center support is recommended for Mother Board Connectors over 7 inches.

## Proven Durability and Long Contact Life

- 100,000 mating cycles, even when hot swapped
- Documented intermittency free performance – no 10 nano second discontinuities during 50m cycles of 0.010 displacement
- Overall cost effectiveness (reduced life cycle costs)

## Multiple Points of Contact Provide Superior Electrical Capability

- 14-70 points of contact per mated contact
- Stable, low resistance – 20 milliohms max.
- Redundant current paths results in lower total resistance
- Proven electrical and gas tight contact sites

**Amphenol Corporation**  
**Amphenol Aerospace**  
**Amphenol Industrial Operations**  
**Amphenol Commercial Air**  
40-60 Delaware Avenue,  
Sidney, NY 13838-1395  
Phone: 607-563-5011  
1-800-678-0141  
Fax: 607-563-5157  
www.amphenol-aerospace.com  
www.amphenol-industrial.com

Amphenol Corporation  
**Amphenol Aerospace**  
2010 Corporate Ridge  
McLean, VA 22101  
Phone: 1-800-678-0141

**OTHER AMPHENOL DIVISIONS**  
**Amphenol Backplane Systems**  
18 Celina Avenue  
Nashua, NH 03063  
Phone: 888-318-3553  
Fax: 603-883-0171  
Web: www.amphenol.abs.com

**Amphenol Canada**  
605 Milner Ave.  
Toronto, Ontario M1B 5X6  
Phone: 416-291-4401  
Fax: 416-292-0647  
Web: www.amphenolcanada.com

**Amphenol PC D**  
72 Cherry Hill Drive  
Beverly, MA 01915  
Phone: 978-624-3400  
Fax: 978-927-1513  
Web: www.amphenolpcd.com  
E-mail: milaero@amphenolpcd.com

**Amphenol Printed Circuits**  
91 Northeastern Boulevard  
Nashua, NH 03062  
Phone: 603-324-4500  
Fax: 603-324-4717  
Web: www.amphenol-tcs.com

**SV Microwave**  
RF Connectors & Components,  
an Amphenol Company  
2400 Centrepark West Drive,  
Suite 100  
West Palm Beach, FL 33409  
Phone: 561-840-1800  
Fax: 561-844-8551  
E-mail: sales@svmicro.com  
Web: www.svmicrowave.com

**Amphenol Nexus**  
50 Sunnyside Avenue  
P.O. Box 10177  
Stamford, CT 06904-2177  
Phone: 203-327-7300  
Fax: 203-324-7623  
E-mail: salesinfo@nexus.com  
Web: www.nexus.com

AUTHORIZED DISTRIBUTORS  
Corporate Headquarters  
Alphabetical Listing

**ARROW ELECTRONICS**  
7459 S. Lima Street  
Englewood, CO 80112-5816  
Phone: 800-833-3557  
Fax: 800-562-3542  
Web: www.arrow.com

**AVNET**  
2211 47th Street  
Phoenix, AZ 85034  
Phone: 800-332-8638  
Web: www.avnet.com

**PEI GENESIS**  
2180 Hornig Road  
Philadelphia, PA 19116  
Phone: 800-523-0727  
Fax: 215-552-8022  
Web: www.peigenesis.com

**POWELL ELECTRONICS**  
200 Commodore Drive  
Logan Township, NJ 08085  
Phone: 800-235-7880  
Fax: 215-937-4655  
Web: www.powell.com

**TTI INC.**  
2441 Northeast Pkwy.  
Fort Worth, TX 76106  
Phone: 800-225-5884  
Fax: 817-740-9494  
Web: www.ttiinc.com

**NEWARK**  
4801 N. Ravenswood  
Chicago, IL 60640-4496  
Phone: 800-463-9275  
Web: www.newarkinc.com

SMALL DISADVANTAGED/  
MINORITY DISTRIBUTORS  
**CHEROKEE NATION DISTRIBUTORS**  
Rt. 3, Box 498  
Stilwell, OK 74960  
Phone: 918-696-3151  
Fax: 918-696-3129  
Web: www.cherokee-corp.com

**JRH ELECTRONICS LLC**  
11001 Lincoln Drive West  
Marlton, NJ 08053  
Phone: 800-467-8309  
Fax: 609-988-8728  
Web: www.jrhelec.com

INTERNATIONAL  
Latin America  
**ARGENTINA**  
Amphenol Argentina  
Avenida Callao 930  
2nd floor Office B Plaza  
C1023AAP Buenos Aires, Argentina  
Phone: (54 11) 48 15 68 86  
Fax: (54 11) 48 14 57 79  
E-mail: sales@bar-tec.com.ar  
Web: www.bar-tec.com.ar

**BRAZIL**  
Amphenol do Brasil Ltda.  
Rua Diogo Moreira 132  
20 Ander, Rooms 2001-2-3  
CEP 05423-010  
Sao Paulo - SP, Brazil  
Phone: (55-11) 3815.1003  
Fax: (55-11) 3815.1629  
E-mail: vendas@amphenol.com.br

**MEXICO**  
Amphenol Mexico  
Prolongacion Reforma 61-6 B2  
Col. Paseo de las Lomas  
C.P. 01330 Mexico D.F., Mexico  
Phone: (52-55) 5258.9984  
Fax: (52-55) 5081.6890  
E-mail: www@amphenolmexico.com

Europe  
**ENGLAND**  
Amphenol Limited  
Thanet Way, Whitstable  
Kent CT5 3JF, United Kingdom  
Phone: (44-1-227) 773200  
Fax: (44-1-227) 276571  
E-mail: info@amphenol.co.uk

**FRANCE**  
Amphenol Socapex  
Promenade de l'Arve, BP29  
Thyvez 74311 948 Cedex, France  
Phone: (33-4) 50892800  
Fax: (33-4) 50962975  
Web: www.amphenol-socapex.com

**FRANCE**  
Amphenol-Air LB  
29, Voie d'Y Vois  
F-08110 Blagny, France  
Phone: (33-3) 2422-7849  
Fax: (33-3) 2422-1319  
Web: www.amphenol-airlb.fr

**GERMANY**  
Amphenol-Air LB GmbH  
Am Kleinbahnhof 4  
D-66740 Saarlouis, Germany  
Phone: (49-6831) 981-00  
Fax: (49-6831) 9810-30  
Web: www.amphenol-airlb.com

**ITALY & REST OF EUROPE**  
Amphenol Italia S.p.A.  
Via Barbaiana 5  
20020 Lainate (Milano), Italy  
Phone: 39-02-932541  
Fax: 39-02-93254444  
E-mail: info@amphenol-it.com

Middle East / Africa  
**ISRAEL**  
Bar-Tec Ltd.  
3 Hagavish St., P.O.B. 279  
Kfir-Barkan Bldg., East Industrial Zone  
Kfar Sava 44102, Israel  
Phone: (972-9) 764.4100  
Fax: (972-9) 7674324  
E-mail: sales@bar-tec.com  
Web: www.bar-tec.com

**SOUTH AFRICA**  
Amphenol South Africa  
30 Impala Road  
2196 Sandton - Chislehurst  
South Africa  
Tel: (27-11) 783-9517  
Fax: (27-11) 783-9519  
E-mail: amphenol\_africa@csi.com  
Web: www.amphenol.co.za

**TURKEY**  
Amphenol Turkiye  
Ayazaga Mah. Meydan Sk. No. 28  
Beybi Giz Plaza, Kat. 263496  
Maslak/Istanbul  
Phone: 90 (212) 335 25 01  
Fax: 990 (212) 335 25 00  
E-mail: saracoglu@amphenol.com.tr  
Web: www.amphenol.com.tr

Asia / Pacific  
**AUSTRALIA**  
Amphenol Australia LTD  
2 Fiveways Blvd. Keysborough  
Melbourne, Victoria 3173 Australia  
Phone: 613 8796 8888  
Fax: 613 8796 8801  
E-mail: www@amphenol.com.au

**RUSSIA**  
Amphenol Russia Office  
8 Yaroslavskaja Str.,  
Floor 2129164 Moscow, Russia  
Phone: 7495 937 6341  
Fax: 7495 937 6319  
E-mail: russia@amphenol.com

**INDIA**  
Amphenol Interconnect India Pvt, Ltd.  
105 Bhosari Industrial Area  
Pune, 411 026, India  
Phone: (91-20) 27120 462  
Fax: (91-20) 27129 158  
E-mail: sales@amphenol-in.com

**JAPAN**  
Amphenol Japan Mil/Aero & Industrial  
471-1, Deba, Ritto-city  
Shiga 520-3041, Japan  
Phone: 81-77-553-8501  
Fax: 81-77-551-2200

Notice: Specifications are subject to change without notice. Contact your nearest Amphenol Corporation Sales Office for the latest specifications. All statements, information and data given herein are believed to be accurate and reliable but are presented without guarantee, warranty, or responsibility of any kind expressed or implied. Statements or suggestions concerning possible use of our products are made without representation or warranty that any such use is free of patent infringement and are not recommendations to infringe any patent. The user should not assume that all safety measures are indicated or that other measures may not be required. Specifications are typical and may not apply to all connectors.  
© 2010 Amphenol Corp. Printed by DP 5/2010

# Amphenol Low Mating Force Rectangular Connectors MIL-DTL-55302 (M55302/166 thru /172)

Amphenol's Low Mating Force Connectors are well known in the connector arena – with proven performance on the ground, in the air, and at sea. – In service for over 25 years, with over 50 million brush contacts fielded; and qualified for use on M1A2 Abrams, F-16 Falcon, F/A-22 Raptor, F-35 Lightning II, AIM-132 ASRAAM and many more applications.

## Four Standard Body Styles

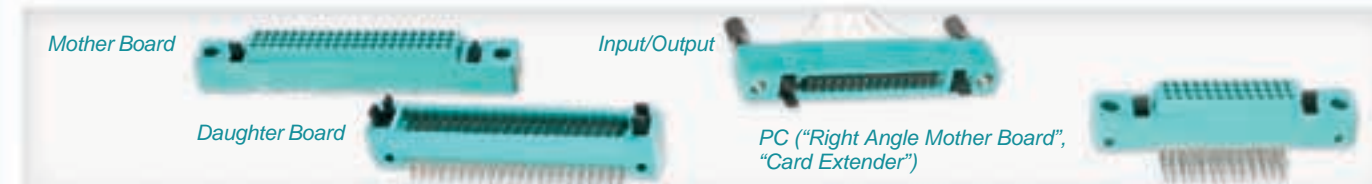

## Key Connector Features

- 0.100 inch center to center, square grid contact spacing
- Application flexibility (parallel boards, perpendicular boards, wire to board, end to end boards, card extenders)
- 2, 3 and 4 row contact arrangements with 10 to 100 contacts per row in one contact per row increments
- Military versions meet MIL-DTL-55302/166 through /172
- Termination versatility; straight & 90° PCB stud, wire wrap & crimp
- Options on termination lengths and plating
- Front release/front removable contacts in Mother Board, Daughter Board and PC version; rear release/rear removable crimp contacts (size 22D) or printed circuit board pins provided with Input/Output connectors
- Accessories available for latching and polarization
- Up to 256 keyed, mating polarizations available
- Hybrids available – mix signal with power, RF or fiber optics
- Smaller sized connector designs with as few as 5 contacts per row
- RoHS compliant versions are available, consult Amphenol Aerospace for more information



## Performance

- voltage rating: 

SL	70,000 ft.
1300	325
- one and one-half ounce max. average contact engaging/separating forces
- 7 million average contact resistance for row A contacts
- (Resistance will vary depending on the point of measurement and the length of the contact.)
- 3 ampere – PCB contacts; 5 ampere – wire wrap / crimp contacts
- –65°C to +125°C temperature rating
- 5 gigaohms minimum insulation resistance

## Materials

- Connector Body – Glass-filled thermoplastic molding material in accordance with MIL-M-24519 type GPT-15F and/or Grade B,
- Class 15 of MIL-P-46161 (UL94V-O)
- Polarization Keys – Glass-filled acetal plastic molding material in accordance with MIL-P-46137
- Locking Screw/Mounting Bushing – Corrosion resistant steel AISI 300 types passivated in accordance with QQ-P-35

## Contacts

- Holders – Copper alloy in accordance with Federal Specification QQ-B-626 or SAE J463
- Wire – Beryllium copper in accordance with Federal Specification ASTM B197
- Sleeves – If applicable, stainless steel in accordance with AMS-5514 passivated in accordance with ASTM A967



Unmated Input/Output and PC Connector

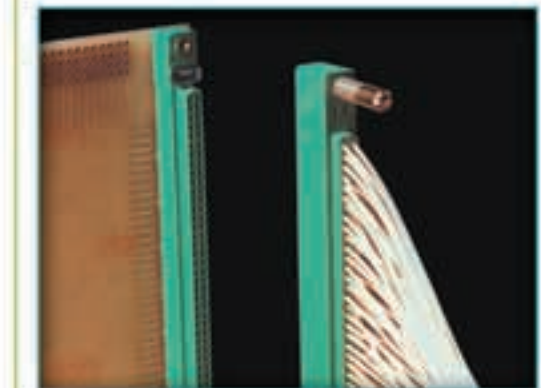

An Input/Output and Mother Board Connector

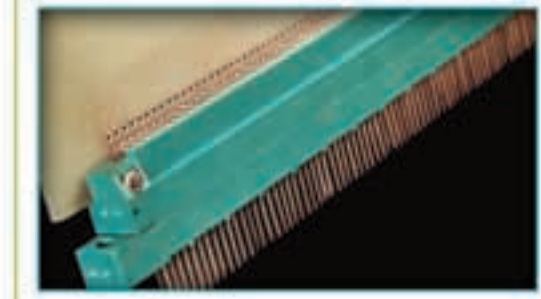

Mated Mother Board and Daughter Board Connector

# Low Mating Force Rectangular Connectors

## selecting the correct mated connection

### STANDARD FOUR BODY STYLES

#### Mother Board Connector (MB)

also can be referred to as a "Back-plane" Connector

- Straight PCB stud or Wire wrap termination
- Mates with: Daughter board or I/O connectors

#### Daughter Board Connector (DB)

also can be referred to as a "Module Connector"

- 90° PCB stud
- Mates with: Mother board or PC connectors

#### Printed Circuit Connector (PC)

also can be referred to as a "Right Angle Mother board Connector" or a "Card Extender Connector"

- 90° PCB stud
- Mates with: I/O or Daughter board connectors

#### Input/Output Connector (I/O)

also can be referred to as a "Cable Connector"

- I/O-C has rear removable crimp contacts
- I/O-P has round PCB stud solder contacts
- Mates with: Mother board or PC connectors

**DB to MB** Mating Boards at Right Angles

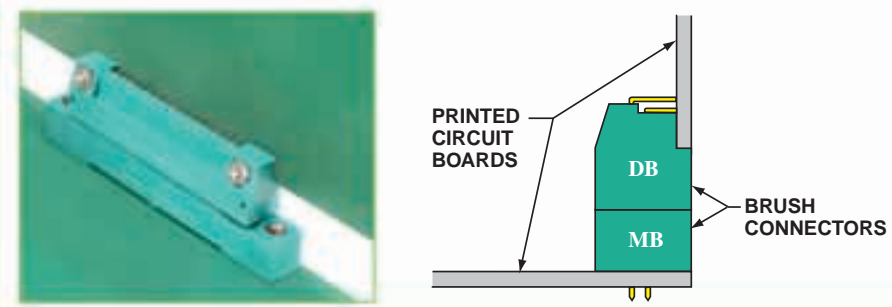

**MB to I/O-C** Discrete Wires to PCB

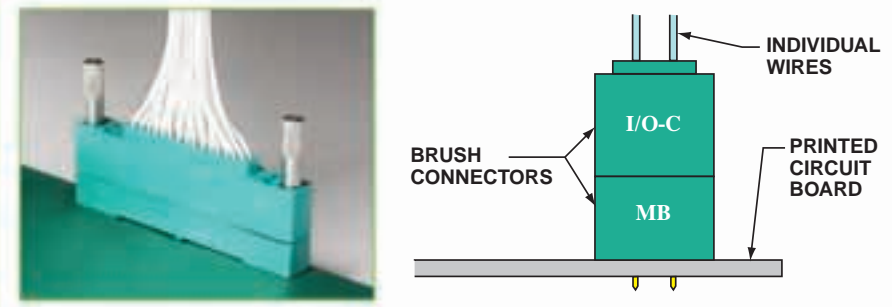

**MB to I/O-P** Mating Parallel Boards

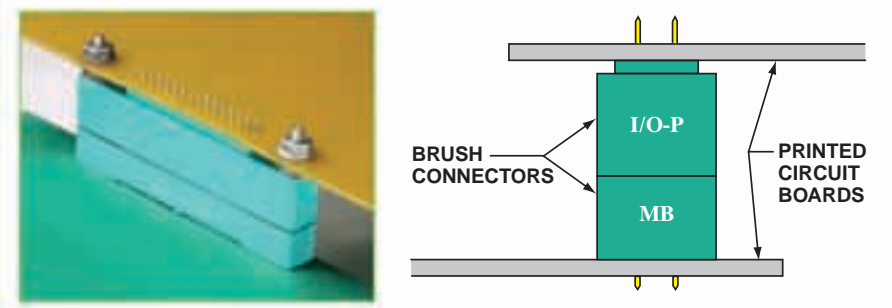

**PC to DB** Mating Boards End to End

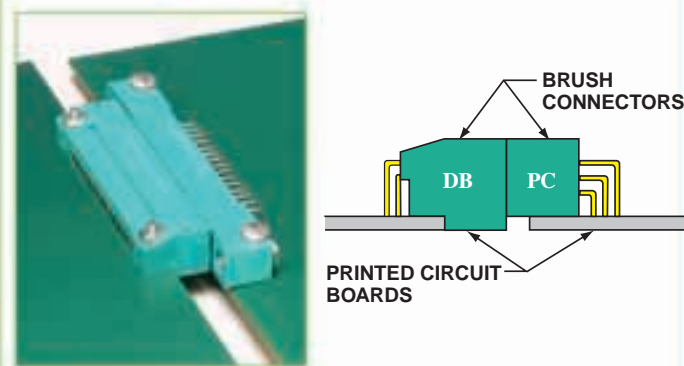

**PC to I/O-C** Discrete Wires to PCB

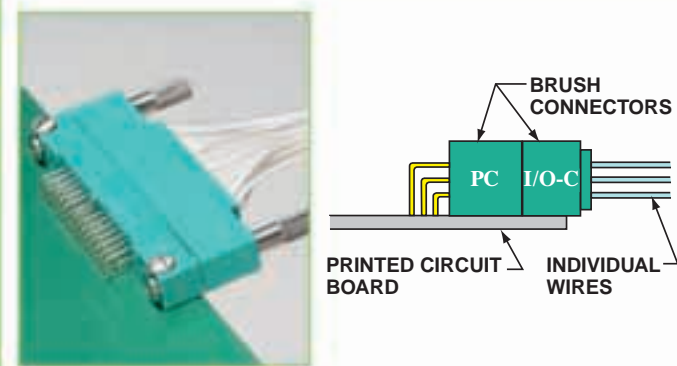

# Low Mating Force Rectangular Connectors

## how to order (military types)

### MB, DB, PC Connectors Military Part Number Ordering Procedure

Example part number M55302/166A10X1 is shown as follows:

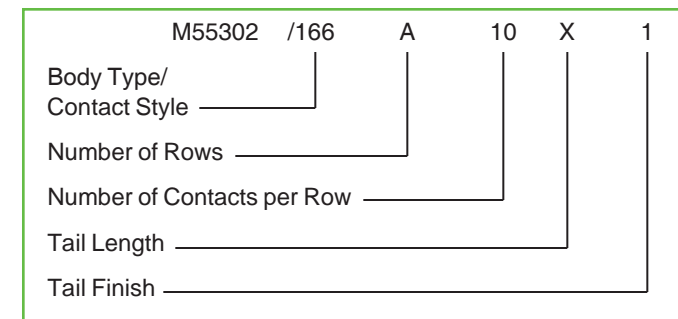

#### Body Type/Contact Style

- /166 designates MB-P (Mother Board, Printed Circuit Board Termination)
- /167 designates MB-W (Mother Board, Wire-wrap Contacts)
- /168 designates PC (Printed Circuit, 90° Printed Circuit Board Termination)
- /170 designates DB (Daughter Board, 90° Printed Circuit Board Termination)

#### Number of Rows

- A – 2 Rows
- B – 3 Rows
- C – 4 Rows

#### Number of Contacts per Row

Contact counts per row range from 10 to 100  
(Only 2 digits permitted in this space; for 100 contacts per row, use 00)

#### Tail Length

MB-P (PCB Termination)*	MB-W** (Wire-wrap)
W – .222 ±.025	Y – .700 ±.025
X – .300 ±.025	Z – .542 ±.025
Y – .145 ±.025	
Z – .113 ±.025	

DB*	PC*
X – .300 ±.025	Y – .150 +.035 –.025
Y – .150 ±.025	Z – .095 +.035 –.025
Z – .120 ±.025	

\* Reference "J" Dimension on all connector drawings in this catalog.  
\*\* For MB-W only: Reference "H" Dimension on connector drawing on page 8.

#### Tail Finish

- 1 Tin lead per MIL-P-81728, 50 to 70% tin, .0001 min. thick over copper
- 2 Gold per MIL-G-45204, type II, grade C, class 00 (01 for MB-W) over nickel per QQ-N-290



### IO Connectors Military Part Number Ordering Procedure

Example part number M55302/169A101 is shown as follows:

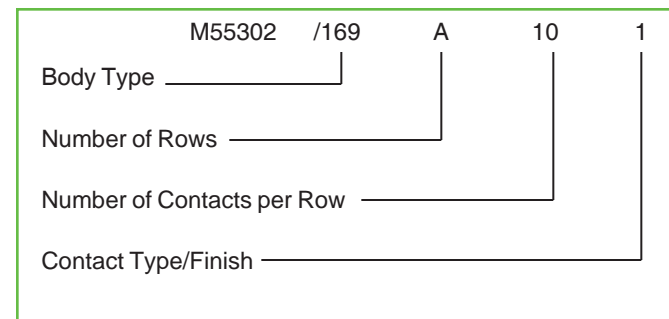

#### Body Type

- /169 designates IO (Input/Output)  
(Contact type/finish is last digit of IO part number - see list of options below)

#### Number of Rows

- A – 2 Rows
- B – 3 Rows
- C – 4 Rows

#### Number of Contacts per Row

Contact counts per row range from 10 to 100  
(Only 2 digits permitted in this space; for 100 contacts per row, use 00)

#### Contact Type/Finish

- 1 Crimp contact – Tin lead per MIL-P-81728, 50 to 70% tin, .0001 min. thick over copper
- 2 Crimp contact – Gold per MIL-G-45204, type II, grade C, class 1 over copper
- 3 Connectors supplied less contacts
- 4 PCB contacts installed with .145 ±.025 stickout – Tin lead per MIL-P-81728, 50 to 70% tin, .0001 min. thick over copper (Reference "J" Dimension on connector drawing on page 16).

#### To Order IO Contacts

(For use with connectors less contacts)

M55302/171-1  
\_\_\_\_\_ suffix designates crimp well finish

#### Crimp well finish

- 1 Crimp contact – Tin lead per MIL-P-81728, 50 to 70% tin, .0001 min. thick over copper
- 2 Crimp contact – Gold per MIL-G-45204, type II, grade C class 1 over copper

To order Accessories, see page 5.

# Low Mating Force Rectangular Connectors

## how to order (commercial types)

### MB, DB, I/O, PC Connectors Proprietary Part Number Ordering Procedure

Example part number MB2-120P- ( ) is shown as follows:

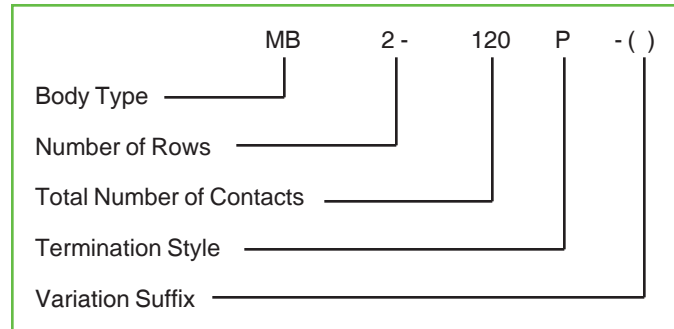

#### Body Type

MB designates Mother Board  
DB designates Daughter Board  
I/O designates Input/Output  
PC designates Printed Circuit

#### Number of Rows

2, 3 or 4 rows

#### Total Number of Contacts

See Contact Arrangements, pages 8 and 9

#### Standard Termination Style

(Stickout values below apply to "J" dimension referenced on individual connector catalog pages).

MBX-XXXP	Straight PCB stud, .021 dia, .113 ±.025 stickout, Sn/Ni plate
MBX-XXXW	Solderless wrap, .025 sq., .507 ±.025 stickout, Sn/Ni plate
DBX-XXXP	90° PCB stud, .021 dia, .085 ±.025 stickout, Sn/Ni plate
IOX-XXXC	Crimp, rear removable contact, size 22D wire well, Sn/Ni plate
IOX-XXXP	PCB stud, .021 dia, .145 ±.025 stickout, Sn/Ni plate
PCX-XXXP	90° PCB stud, .021 dia., .095 <sup>+.035</sup> / <sub>-.025</sub> stickout Sn/Ni plate

#### LEGEND:

Sn/Ni designates Tin over Nickel  
Au/Ni designates Gold over Nickel  
Au/Cu designates Gold over Copper



SnPb/Cu designates Tin-Lead over Copper

#### Variation Suffix

(Stickout values below apply to "J" dimension referenced on individual connector catalog pages.)

(700)	Gold plate in accordance with MIL-G-45204, type II, .000030 min. thick gold (.000050 for solderless wrap) over .000050 min. thick nickel (standard termination length)
(701)	Gold plate in accordance with MIL-G-45204, type II, .000050 min. thick gold over .00015 min. thick copper (standard termination length)
(702)	PCB stud stickout of .145, Sn/Ni plate, MB-P
(703)	Au/Ni [same as (700)], PCB stud stickout of .145, MB-P
(704)	Au/Cu [same as (701)], PCB stud stickout of .145, MB-P
(705)	90° PCB stud, .120 stickout, Sn/Ni plate, DB
(706)	Au/Ni [same as (700)], 90° PCB stud .120 stickout, DB
(707)	Au/Cu [same as (701)], 90° PCB .120 stickout, DB
(709)	PCB stud stickout of .300 DB (90°), .300 MB-P & .335 IO-P, Sn/Ni plate
(710)	Solderless wrap, .025 sq., .665 stickout, Sn/Ni plate, MB-W
(711)	Solderless wrap, .025 sq., .665 stickout, Au/Ni, [same as (700)], MB-W
(713)	PCB stud stickout of .060, Sn/Ni plate, IO-P
(714)	90° PCB stud stickout of .150, Sn/Ni plate, PC & DB
(715)	Solderless wrap, .025 sq., .665 stickout, Au/Cu [same as (701)], MB-W
(716)	90° PCB stud stickout of .085 matte tin, DB
(717)	90° PCB stud stickout of .095 matte tin, PC
(718)	90° PCB stud stickout of .120 matte tin, DB
(719)	PCB stud stickout of .300 MB-P & .335 IO-P, matte tin
(720)	PCB stud stickout of .060 matte tin, IO-P
(721)	PCB stud stickout of .500, Sn/Ni plate, IO-P
(722)	PCB stud stickout of .356 matte tin, MB-P
(723)	PCB stud stickout of .192, Sn/Ni plate, MB-P
(724)	90° PCB stud stickout of .095, RTV potted rear, Sn/Ni plate, PC
(725)	90° PCB stud stickout of .120, RTV potted rear, Sn/Ni plate, DB
(726)	90° PCB stud stickout of .150, RTV potted rear, Sn/Ni plate, PC & DB
(727)	PCB stud stickout of .145, RTV potted rear, Sn/Ni plate, MB-P
(728)	PCB stud stickout of .145, Au/Ni, [same as (700)], RTV potted rear, MB-P
(729)	90° PCB stud stickout of .120, Au/Ni, [same as (700)], RTV potted rear, DB
(730)	90° PCB stud stickout of .150, Au/Ni, [same as (700) above], PC and DB
(731)	PCB stud stickout of .145, matte tin, MB-P

Variation Suffixes continued on next page.



# Low Mating Force Rectangular Connectors

## how to order (commercial types)/accessories

### MB, DB, I/O, PC Connectors Proprietary Part Number Ordering Procedure Variation Suffix, cont.

(732)	PCB stud stickout of .300 DB (90°), .300 MB-P and .335 IO-P, Au/Cu [same as (701)],	(750)	PCB stud stickout of .172 termination, Au/Ni, [same as (700)], RTV potted rear, MB-P
(733)	PCB stud stickout of .421, matte tin, MB-P	(751)	90° PCB stud stickout of .150, Sn/Ni, epoxy potted rear, PC
(734)	Solderless wrap .025 sq.; .665 stickout, Au/Ni, [same as (700)], RTV potted rear, MB-W	(752)	Au/Ni, epoxy potted rear, standard termination length
(735)	RTV potted rear, standard termination length, Au/Ni, [same as (700)]	(753)	Solderless wrap .025 sq.; .665 stickout, Au/Ni, [same as (700)], epoxy potted rear, MB-W
(736)	RTV potted rear, standard termination length, Sn/Ni [use (724) for PC]	(754)	PCB stud stickout of .172 termination, SnPb/Cu (MIL-Spec), MB-P
(737)	PCB stud stickout of .300 DB (90°), .300 MB-P and .335 IO-P, Au/Ni, [same as (700)], RTV potted rear	(757)	PCB stud, .391 stickout, matte tin, MB-P
(738)	PCB stud stickout of .192 SnPb/Cu (Mil-Spec), MB-P	(758)	PCB stud, .172 stickout, Au/Ni, [same as (700)], epoxy potted rear, MB-P
(739)	PCB stud stickout of .300 DB (90°), .300 MB-P and .335 IO-P, RTV potted rear, Sn/Ni	(760)	PCB stud, .192 stickout, Au/Ni (Mil-Spec), MB-P
(740)	Solderless wrap .025 sq.; .665 stickout, Sn/Ni, RTV potted rear, MB-W	(761)	90° PCB stud, .120 stickout, Sn/Ni, epoxy potted rear, DB
(741)	Solderless wrap .025 sq.; .280 stickout, Au/Ni, [same as (700)], MB-W	(762)	PCB stud, .145 stickout, Au/Ni (Mil-Spec), epoxy potted rear, MB-P
(742)	PCB .145, Au/Ni, [same as (700)], epoxy potted rear, MB-P	(763)	PCB stud, .145 stickout, SnPb/Cu (Mil-Spec), epoxy potted rear, MB-P
(743)	90° PCB .120, Au/Ni, [same as (700)], epoxy potted rear, DB	(764)	90° PCB stud, .150 stickout, SnPb/Cu (Mil-Spec), epoxy potted rear, DB & PC
(744)	90° PCB .120, Au/Ni, [same as (700)], (MIL-Spec), epoxy potted rear, DB	(765)	PCB stud, stickout of .300 DB (90°), .300 MB-P, SnPb/Cu (Mil-Spec), epoxy potted rear
(746)	90° PCB .120, SnPb/Cu, (MIL-Spec), epoxy potted rear, DB	(766)	90° PCB stud, .120 stickout, Au/Ni (Mil-Spec), epoxy potted rear, DB
(747)	PCB stud stickout of .200, Sn/Ni, IO-P	(767)	PCB stud, .192 stickout, Au/Ni (Mil-Spec), epoxy potted rear, MB-P
(748)	PCB stud stickout of .145, Sn/Ni, epoxy potted rear, MB-P	(768)	PCB stud, .172 stickout, Au/Ni (Mil-Spec), MB-P
(749)	PCB, epoxy potted rear, standard termination length, Sn/Ni	(769)	90° PCB stud, .200 stickout, Au/Ni (Mil-Spec), DB
		(770)	90° PCB stud, .260 stickout, Au/Ni (Mil-Spec), DB
		(773)	90° PCB stud, .150 stickout, Au/Ni (Mil-Spec), RTV potted rear, PC & DB

### Accessories

Amphenol® Low Mating Force Connectors are shipped less accessory items.

Accessories may be ordered by either military or proprietary part numbers shown below:

Accessory Item	Series	Military Part Number	Proprietary Part Number	Qty. Required
Polarization Keys	MB, DB, IO, PC	M55302/78-02	10-285422-2	4*
Locking/Mounting Bushing	MB	M55302/172-01	10-411196-3	2
Alternate Length Bushing (Longer)	MB	M55302/172-02	10-411196-5	2
Locking Bushing	PC	M55302/172-05	10-411196-4	2
Locking Screw, Plain	IO	M55302/172-04	10-502599	2
Locking Screw, Slotted	IO	-	10-502599-1	2
Locking Screw, Slotted (Low Profile)	IO	M55302/172-03	10-502599-2	2
Test Probe Kit	MB, DB, IO, PC	-	11-10400-22	1**

See pages 24-29 for more detailed information on these accessory items and how they are assembled into connectors.

\* 4 Keys required per connector half, if used  
\*\* One kit per connector gender is recommended

# Low Mating Force Rectangular Connectors

## connector row and cavity identification, contact arrangements

### BRUSH CONNECTOR ROW AND CAVITY IDENTIFICATION

Contact rows and cavities are identified with molded-in letters and numbers respectively and, depending on the connector style, are located either on the front, rear or both faces of the connector. See illustration at right.

Note: The brand name of Bendix may appear molded-in on connectors. As manufacturing molds are remade, the correct Amphenol name will replace the former Bendix name.

As shown in the second illustration at right, row identification is always at the radius end and begins with Row "A". Contact cavity identification always starts at radius end and begins with cavity #6 and then every fifth cavity thereafter, except for arrangements consisting of 10 contacts per row, which lack numerals. Up to every 9 contact locations at the high numeral end of the contact row will not be identified.

### Mother Board and PC Connectors

Contact rows are identified on the front and rear faces. Contact cavities are identified on the rear face.

### Daughter Board Connectors

Contact rows and cavities are identified on the front face.

### Input/Output Connectors

Contact rows and cavities are identified on the rear face.

### Contacts

Contacts are supplied with MB, DB, IO and PC Connector Series assemblies as ordered.

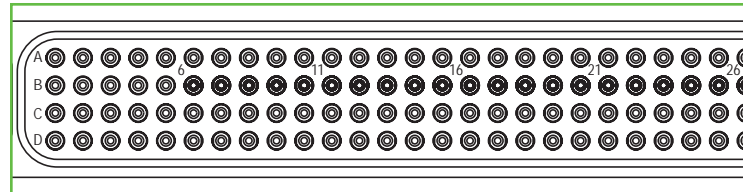

CONTACT ROWS AND CAVITIES ARE IDENTIFIED WITH MOLDED-IN LETTERS AND NUMBERS (FRONT FACE OF DAUGHTER BOARD SHOWN)

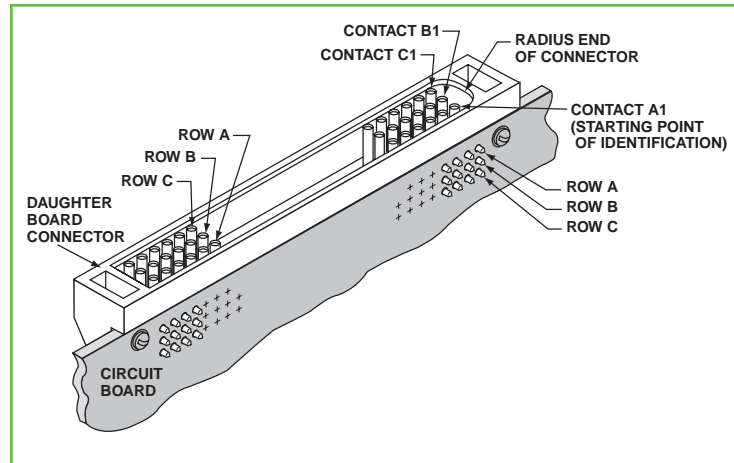

IDENTIFICATION STARTS AT THE RADIUS END OF THE CONNECTOR

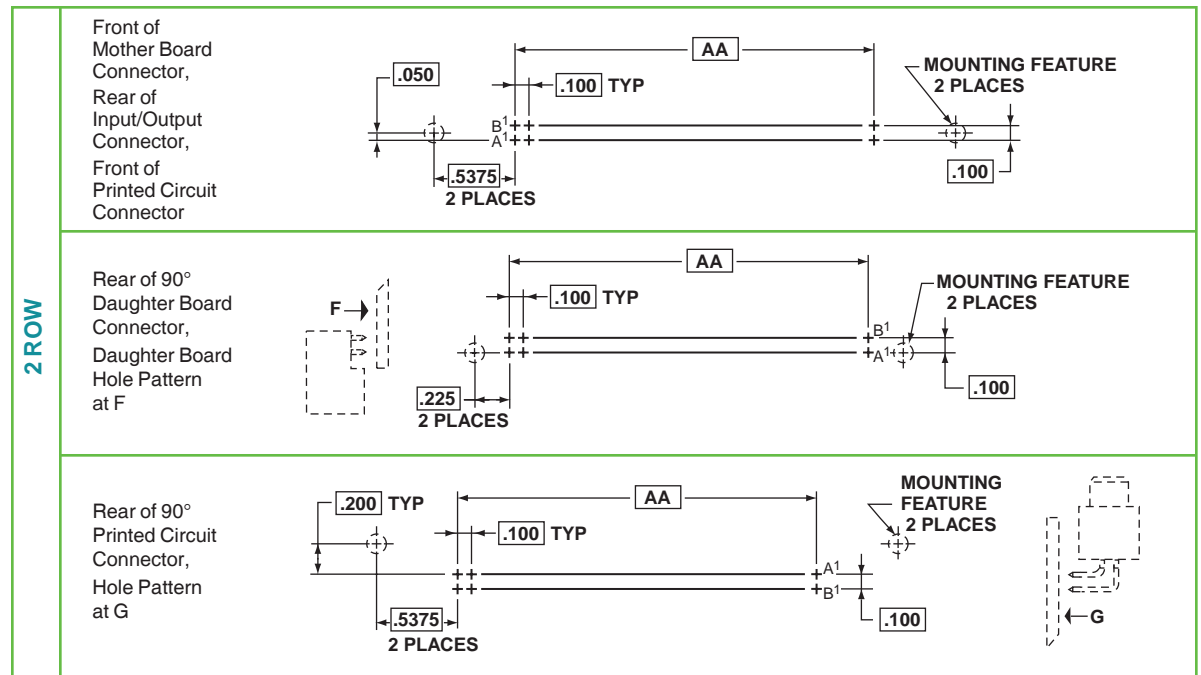

### 2 ROW 10 per Row

Total Contacts	AA
20	.900
30	1.400
40	1.900
50	2.400
60	2.900
70	3.400
80	3.900
90	4.400
100	4.900
110	5.400
120	5.900
130	6.400
140	6.900
150	7.400
160	7.900
170	8.400
180	8.900
190	9.400
200	9.900

□ Designates Basic Dimension.  
Consult Amphenol drawing for solderless wrap contact fixturing (datum) hole locations to facilitate connector alignment.

# Low Mating Force Rectangular Connectors

## contact arrangements, cont.

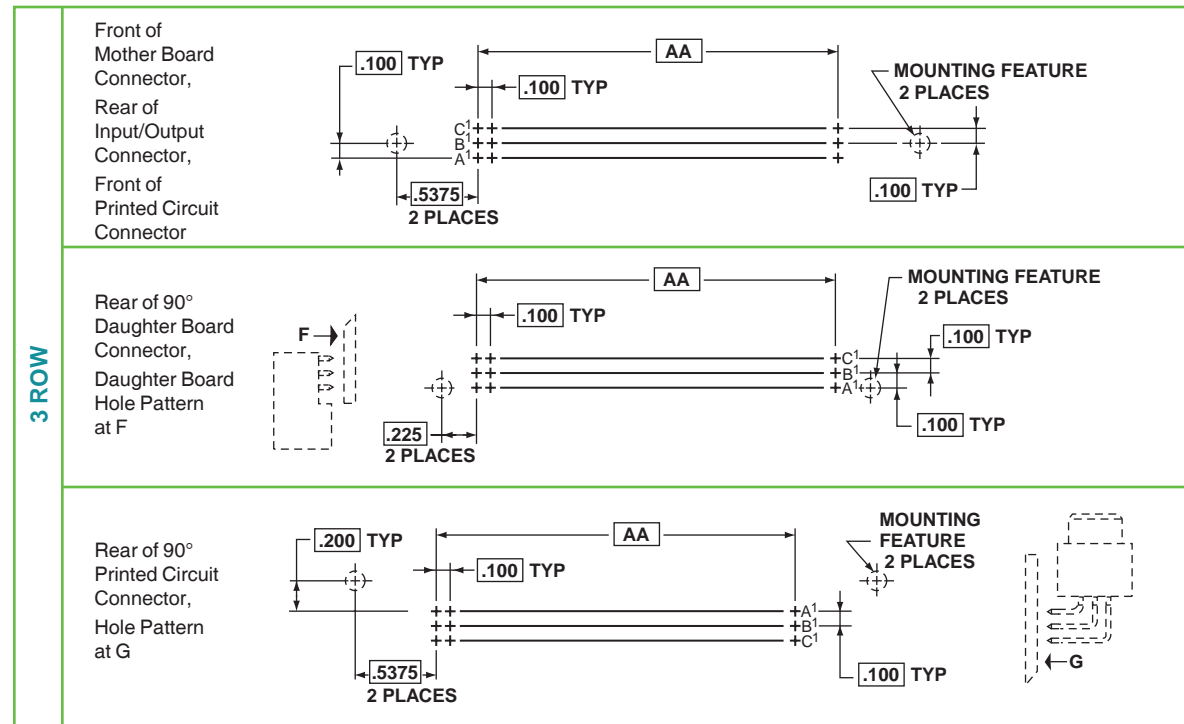

**3 ROW**  
10 per Row

Total Contacts	AA
30	.900
45	1.400
60	1.900
75	2.400
90	2.900
105	3.400
120	3.900
135	4.400
150	4.900
180	5.900
195	6.400
210	6.900
225	7.400
240	7.900
255	8.400
270	8.900
285	9.400
300	9.900

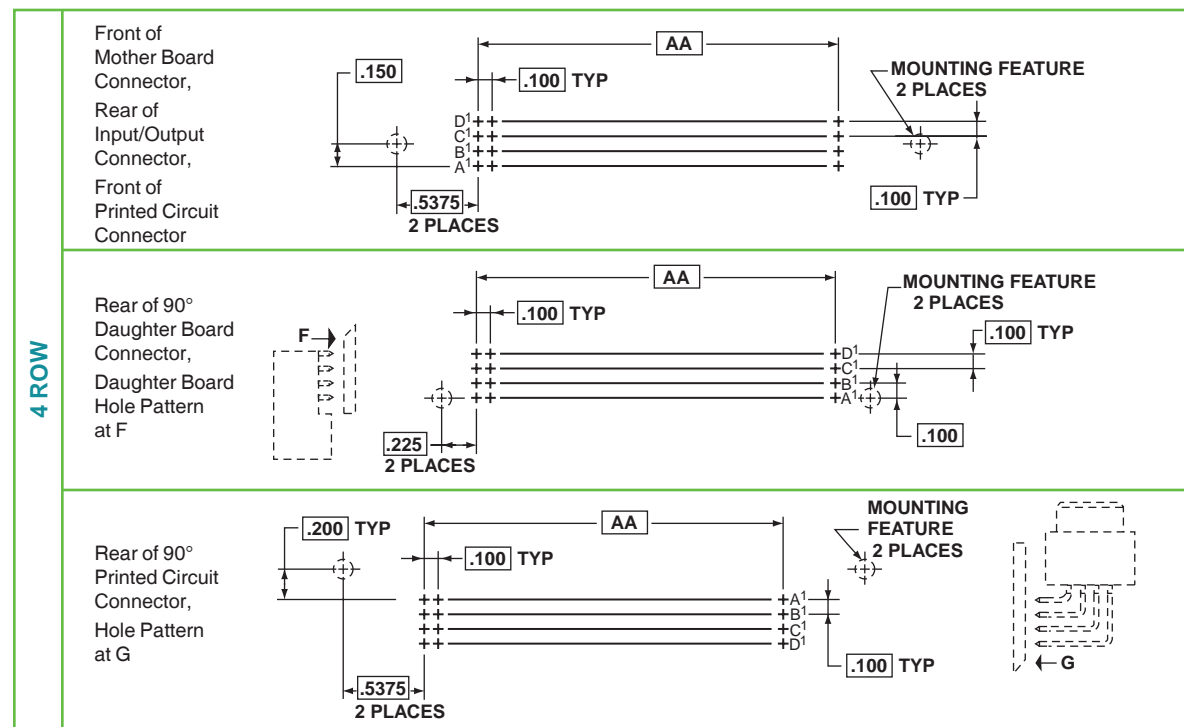

**4 ROW**  
10 Per Row

Total Contacts	AA
40	.900
60	1.400
80	1.900
100	2.400
120	2.900
140	3.400
160	3.900
180	4.400
200	4.900
220	5.400
240	5.900
260	6.400
280	6.900
300	7.400
320	7.900
340	8.400
360	8.900
380	9.400
400	9.900

□ Designates Basic Dimension.  
Consult Amphenol drawing for solderless wrap contact fixturing (datum) hole locations to facilitate connector alignment.

# Low Mating Force mother board connector

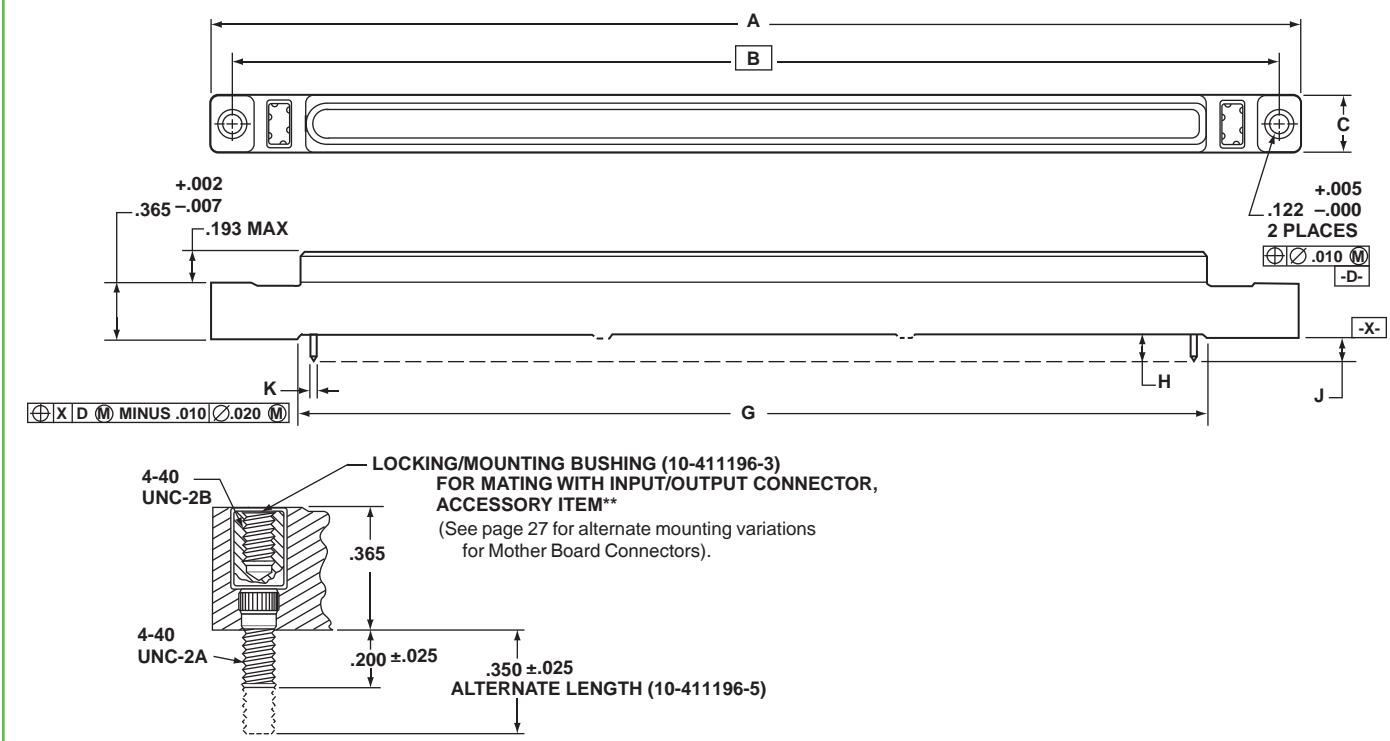

### MATES WITH DB AND IO SERIES CONNECTORS

Notes:  
When mating with DB connector, a total of .035 inch minimum radial pilot is available for connector body alignment.  
All dimensions for reference only.  
Polarization keys are not supplied as part of MB Connector Series assemblies. See Accessories How to Order, page 5 and further description, page 24.  
\*\* Locking/mounting bushings are not supplied as part of MB Connector Series assemblies. See Accessories How to Order, page 5 and further description on page 27.  
□ Designates Basic Dimension  
Consult Amphenol drawing for solderless wrap contact fixturing (datum) hole locations to facilitate connector alignment.

Contact Data				
Description	Termination Style Letter	H ±.020	J ±.020	K ±.002
Round PCB Stud Solder Termination	P	.148	.113	.021 Dia.
	P-(702)	.180	.145	.021 Dia.
Square Solderless Wrap Termination	P-(709)	.335	.300	.021 Dia.
	W	.542	.507	.025 Sq.
	W-(710)	.700	.665	.025 Sq.

NOTE: Other variations available - see pages 4 and 5, or consult Amphenol Aerospace.

# Low Mating Force

## mother board connector

### 2 row contact arrangements

Number of Contacts	MB Number*	A Max.	B	C Max.	G Min.
020	MB2-020(*)	2.295	1.975	.390	1.040
022	MB2-022(*)	2.395	2.075	.390	1.140
024	MB2-024(*)	2.495	2.175	.390	1.240
026	MB2-026(*)	2.595	2.275	.390	1.340
028	MB2-028(*)	2.695	2.375	.390	1.440
030	MB2-030(*)	2.795	2.475	.390	1.540
032	MB2-032(*)	2.895	2.575	.390	1.640
034	MB2-034(*)	2.995	2.675	.390	1.740
036	MB2-036(*)	3.095	2.775	.390	1.840
038	MB2-038(*)	3.195	2.875	.390	1.940
040	MB2-040(*)	3.295	2.975	.390	2.040
042	MB2-042(*)	3.395	3.075	.390	2.140
044	MB2-044(*)	3.495	3.175	.390	2.240
046	MB2-046(*)	3.595	3.275	.390	2.340
048	MB2-048(*)	3.695	3.375	.390	2.440
050	MB2-050(*)	3.795	3.475	.390	2.540
052	MB2-052(*)	3.895	3.575	.390	2.640
054	MB2-054(*)	3.995	3.675	.390	2.740
056	MB2-056(*)	4.095	3.775	.390	2.840
058	MB2-058(*)	4.195	3.875	.390	2.940
060	MB2-060(*)	4.295	3.975	.390	3.040
062	MB2-062(*)	4.395	4.075	.390	3.140
064	MB2-064(*)	4.495	4.175	.390	3.240
066	MB2-066(*)	4.595	4.275	.390	3.340
068	MB2-068(*)	4.695	4.375	.390	3.440
070	MB2-070(*)	4.795	4.475	.390	3.540
072	MB2-072(*)	4.895	4.575	.390	3.640
074	MB2-074(*)	4.995	4.675	.390	3.740
076	MB2-076(*)	5.095	4.775	.390	3.840
078	MB2-078(*)	5.195	4.875	.390	3.940
080	MB2-080(*)	5.295	4.975	.390	4.040
082	MB2-082(*)	5.395	5.075	.390	4.140
084	MB2-084(*)	5.495	5.175	.390	4.240
086	MB2-086(*)	5.595	5.275	.390	4.340
088	MB2-088(*)	5.695	5.375	.390	4.440
090	MB2-090(*)	5.795	5.475	.390	4.540
092	MB2-092(*)	5.895	5.575	.390	4.640
094	MB2-094(*)	5.995	5.675	.390	4.740
096	MB2-096(*)	6.095	5.775	.390	4.840
098	MB2-098(*)	6.195	5.875	.390	4.940
100	MB2-100(*)	6.295	5.975	.390	5.040
102	MB2-102(*)	6.395	6.075	.390	5.140
104	MB2-104(*)	6.495	6.175	.390	5.240
106	MB2-106(*)	6.595	6.275	.390	5.340
108	MB2-108(*)	6.695	6.375	.390	5.440
110	MB2-110(*)	6.795	6.475	.390	5.540

Number of Contacts	MB Number*	A Max.	B	C Max.	G Min.
112	MB2-112(*)	6.895	6.575	.390	5.640
114	MB2-114(*)	6.995	6.675	.390	5.740
116	MB2-116(*)	7.095	6.775	.390	5.840
118	MB2-118(*)	7.195	6.875	.390	5.940
120	MB2-120(*)	7.295	6.975	.390	6.040
122	MB2-122(*)	7.395	7.075	.390	6.140
124	MB2-124(*)	7.495	7.175	.390	6.240
126	MB2-126(*)	7.595	7.275	.390	6.340
128	MB2-128(*)	7.695	7.375	.390	6.440
130	MB2-130(*)	7.795	7.475	.390	6.540
132	MB2-132(*)	7.895	7.575	.390	6.640
134	MB2-134(*)	7.995	7.675	.390	6.740
136	MB2-136(*)	8.095	7.775	.390	6.840
138	MB2-138(*)	8.195	7.875	.390	6.940
140	MB2-140(*)	8.295	7.975	.390	7.040
142	MB2-142(*)	8.395	8.075	.390	7.140
144	MB2-144(*)	8.495	8.175	.390	7.240
146	MB2-146(*)	8.595	8.275	.390	7.340
148	MB2-148(*)	8.695	8.375	.390	7.440
150	MB2-150(*)	8.795	8.475	.390	7.540
152	MB2-152(*)	8.895	8.575	.390	7.640
154	MB2-154(*)	8.995	8.675	.390	7.740
156	MB2-156(*)	9.095	8.775	.390	7.840
158	MB2-158(*)	9.195	8.875	.390	7.940
160	MB2-160(*)	9.295	8.975	.390	8.040
162	MB2-162(*)	9.395	9.075	.390	8.140
164	MB2-164(*)	9.495	9.175	.390	8.240
166	MB2-166(*)	9.595	9.275	.390	8.340
168	MB2-168(*)	9.695	9.375	.390	8.440
170	MB2-170(*)	9.795	9.475	.390	8.540
172	MB2-172(*)	9.895	9.575	.390	8.640
174	MB2-174(*)	9.995	9.675	.390	8.740
176	MB2-176(*)	10.095	9.775	.390	8.840
178	MB2-178(*)	10.195	9.875	.390	8.940
180	MB2-180(*)	10.295	9.975	.390	9.040
182	MB2-182(*)	10.395	10.075	.390	9.140
184	MB2-184(*)	10.495	10.175	.390	9.240
186	MB2-186(*)	10.595	10.275	.390	9.340
188	MB2-188(*)	10.695	10.375	.390	9.440
190	MB2-190(*)	10.795	10.475	.390	9.540
192	MB2-192(*)	10.895	10.575	.390	9.640
194	MB2-194(*)	10.995	10.675	.390	9.740
196	MB2-196(*)	11.095	10.775	.390	9.840
198	MB2-198(*)	11.195	10.875	.390	9.940
200	MB2-200(*)	11.295	10.975	.390	10.040

\*See How to Order, pages 3, 4 and 5.

# Low Mating Force mother board connector 3 row contact arrangements

Number of Contacts	MB Number*	A Max.	B	C Max.	G Min.
030	MB3-030(*)	2.295	1.975	.490	1.040
033	MB3-033(*)	2.395	2.075	.490	1.140
036	MB3-036(*)	2.495	2.175	.490	1.240
039	MB3-039(*)	2.595	2.275	.490	1.340
042	MB3-042(*)	2.695	2.375	.490	1.440
045	MB3-045(*)	2.795	2.475	.490	1.540
048	MB3-048(*)	2.895	2.575	.490	1.640
051	MB3-051(*)	2.995	2.675	.490	1.740
054	MB3-054(*)	3.095	2.775	.490	1.840
057	MB3-057(*)	3.195	2.875	.490	1.940
060	MB3-060(*)	3.295	2.975	.490	2.040
063	MB3-063(*)	3.395	3.075	.490	2.140
066	MB3-066(*)	3.495	3.175	.490	2.240
069	MB3-069(*)	3.595	3.275	.490	2.340
072	MB3-072(*)	3.695	3.375	.490	2.440
075	MB3-075(*)	3.795	3.475	.490	2.540
078	MB3-078(*)	3.895	3.575	.490	2.640
081	MB3-081(*)	3.995	3.675	.490	2.740
084	MB3-084(*)	4.095	3.775	.490	2.840
087	MB3-087(*)	4.195	3.875	.490	2.940
090	MB3-090(*)	4.295	3.975	.490	3.040
093	MB3-093(*)	4.395	4.075	.490	3.140
096	MB3-096(*)	4.495	4.175	.490	3.240
099	MB3-099(*)	4.595	4.275	.490	3.340
102	MB3-102(*)	4.695	4.375	.490	3.440
105	MB3-105(*)	4.795	4.475	.490	3.540
108	MB3-108(*)	4.895	4.575	.490	3.640
111	MB3-111(*)	4.995	4.675	.490	3.740
114	MB3-114(*)	5.095	4.775	.490	3.840
117	MB3-117(*)	5.195	4.875	.490	3.940
120	MB3-120(*)	5.295	4.975	.490	4.040
123	MB3-123(*)	5.395	5.075	.490	4.140
126	MB3-126(*)	5.495	5.175	.490	4.240
129	MB3-129(*)	5.595	5.275	.490	4.340
132	MB3-132(*)	5.695	5.375	.490	4.440
135	MB3-135(*)	5.795	5.475	.490	4.540
138	MB3-138(*)	5.895	5.575	.490	4.640
141	MB3-141(*)	5.995	5.675	.490	4.740
144	MB3-144(*)	6.095	5.775	.490	4.840
147	MB3-147(*)	6.195	5.875	.490	4.940
150	MB3-150(*)	6.295	5.975	.490	5.040
153	MB3-153(*)	6.395	6.075	.490	5.140
156	MB3-156(*)	6.495	6.175	.490	5.240
159	MB3-159(*)	6.595	6.275	.490	5.340
162	MB3-162(*)	6.695	6.375	.490	5.440
165	MB3-165(*)	6.795	6.475	.490	5.540

Number of Contacts	MB Number*	A Max.	B	C Max.	G Min.
168	MB3-168(*)	6.895	6.575	.490	5.640
171	MB3-171(*)	6.995	6.675	.490	5.740
174	MB3-174(*)	7.095	6.775	.490	5.840
177	MB3-177(*)	7.195	6.875	.490	5.940
180	MB3-180(*)	7.295	6.975	.490	6.040
183	MB3-183(*)	7.395	7.075	.490	6.140
186	MB3-186(*)	7.495	7.175	.490	6.240
189	MB3-189(*)	7.595	7.275	.490	6.340
192	MB3-192(*)	7.695	7.375	.490	6.440
195	MB3-195(*)	7.795	7.475	.490	6.540
198	MB3-198(*)	7.895	7.575	.490	6.640
201	MB3-201(*)	7.995	7.675	.490	6.740
204	MB3-204(*)	8.095	7.775	.490	6.840
207	MB3-207(*)	8.195	7.875	.490	6.940
210	MB3-210(*)	8.295	7.975	.490	7.040
213	MB3-213(*)	8.395	8.075	.490	7.140
216	MB3-216(*)	8.495	8.175	.490	7.240
219	MB3-219(*)	8.595	8.275	.490	7.340
222	MB3-222(*)	8.695	8.375	.490	7.440
225	MB3-225(*)	8.795	8.475	.490	7.540
228	MB3-228(*)	8.895	8.575	.490	7.640
231	MB3-231(*)	8.995	8.675	.490	7.740
234	MB3-234(*)	9.095	8.775	.490	7.840
237	MB3-237(*)	9.195	8.875	.490	7.940
240	MB3-240(*)	9.295	8.975	.490	8.040
243	MB3-243(*)	9.395	9.075	.490	8.140
246	MB3-246(*)	9.495	9.175	.490	8.240
249	MB3-249(*)	9.595	9.275	.490	8.340
252	MB3-252(*)	9.695	9.375	.490	8.440
255	MB3-255(*)	9.795	9.475	.490	8.540
258	MB3-258(*)	9.895	9.575	.490	8.640
261	MB3-261(*)	9.995	9.675	.490	8.740
264	MB3-264(*)	10.095	9.775	.490	8.840
267	MB3-267(*)	10.195	9.875	.490	8.940
270	MB3-270(*)	10.295	9.975	.490	9.040
273	MB3-273(*)	10.395	10.075	.490	9.140
276	MB3-276(*)	10.495	10.175	.490	9.240
279	MB3-279(*)	10.595	10.275	.490	9.340
282	MB3-282(*)	10.695	10.375	.490	9.440
285	MB3-285(*)	10.795	10.475	.490	9.540
288	MB3-288(*)	10.895	10.575	.490	9.640
291	MB3-291(*)	10.995	10.675	.490	9.740
294	MB3-294(*)	11.095	10.775	.490	9.840
297	MB3-297(*)	11.195	10.875	.490	9.940
300	MB3-300(*)	11.295	10.975	.490	10.040

\*See How to Order, pages 3, 4 and 5.

# Low Mating Force

## mother board connector

### 4 row contact arrangements

Number of Contacts	MB Number*	A Max.	B	C Max.	G Min.
040	MB4-040(*)	2.295	1.975	.590	1.040
044	MB4-044(*)	2.395	2.075	.590	1.140
048	MB4-048(*)	2.495	2.175	.590	1.240
052	MB4-052(*)	2.595	2.275	.590	1.340
056	MB4-056(*)	2.695	2.375	.590	1.440
060	MB4-060(*)	2.795	2.475	.590	1.540
064	MB4-064(*)	2.895	2.575	.590	1.640
068	MB4-068(*)	2.995	2.675	.590	1.740
072	MB4-072(*)	3.095	2.775	.590	1.840
076	MB4-076(*)	3.195	2.875	.590	1.940
080	MB4-080(*)	3.295	2.975	.590	2.040
084	MB4-084(*)	3.395	3.075	.590	2.140
088	MB4-088(*)	3.495	3.175	.590	2.240
092	MB4-092(*)	3.595	3.275	.590	2.340
096	MB4-096(*)	3.695	3.375	.590	2.440
100	MB4-100(*)	3.795	3.475	.590	2.540
104	MB4-104(*)	3.895	3.575	.590	2.640
108	MB4-108(*)	3.995	3.675	.590	2.740
112	MB4-112(*)	4.095	3.775	.590	2.840
116	MB4-116(*)	4.195	3.875	.590	2.940
120	MB4-120(*)	4.295	3.975	.590	3.040
124	MB4-124(*)	4.395	4.075	.590	3.140
128	MB4-128(*)	4.495	4.175	.590	3.240
132	MB4-132(*)	4.595	4.275	.590	3.340
136	MB4-136(*)	4.695	4.375	.590	3.440
140	MB4-140(*)	4.795	4.475	.590	3.540
144	MB4-144(*)	4.895	4.575	.590	3.640
148	MB4-148(*)	4.995	4.675	.590	3.740
152	MB4-152(*)	5.095	4.775	.590	3.840
156	MB4-156(*)	5.195	4.875	.590	3.940
160	MB4-160(*)	5.295	4.975	.590	4.040
164	MB4-164(*)	5.395	5.075	.590	4.140
168	MB4-168(*)	5.495	5.175	.590	4.240
172	MB4-172(*)	5.595	5.275	.590	4.340
176	MB4-176(*)	5.695	5.375	.590	4.440
180	MB4-180(*)	5.795	5.475	.590	4.540
184	MB4-184(*)	5.895	5.575	.590	4.640
188	MB4-188(*)	5.995	5.675	.590	4.740
192	MB4-192(*)	6.095	5.775	.590	4.840
196	MB4-196(*)	6.195	5.875	.590	4.940
200	MB4-200(*)	6.295	5.975	.590	5.040
204	MB4-204(*)	6.395	6.075	.590	5.140
208	MB4-208(*)	6.495	6.175	.590	5.240
212	MB4-212(*)	6.595	6.275	.590	5.340
216	MB4-216(*)	6.695	6.375	.590	5.440
220	MB4-220(*)	6.795	6.475	.590	5.540

Number of Contacts	MB Number*	A Max.	B	C Max.	G Min.
224	MB4-224(*)	6.895	6.575	.590	5.640
228	MB4-228(*)	6.995	6.675	.590	5.740
232	MB4-232(*)	7.095	6.775	.590	5.840
236	MB4-236(*)	7.195	6.875	.590	5.940
240	MB4-240(*)	7.295	6.975	.590	6.040
244	MB4-244(*)	7.395	7.075	.590	6.140
248	MB4-248(*)	7.495	7.175	.590	6.240
252	MB4-252(*)	7.595	7.275	.590	6.340
256	MB4-256(*)	7.695	7.375	.590	6.440
260	MB4-260(*)	7.795	7.475	.590	6.540
264	MB4-264(*)	7.895	7.575	.590	6.640
268	MB4-268(*)	7.995	7.675	.590	6.740
272	MB4-272(*)	8.095	7.775	.590	6.840
276	MB4-276(*)	8.195	7.875	.590	6.940
280	MB4-280(*)	8.295	7.975	.590	7.040
284	MB4-284(*)	8.395	8.075	.590	7.140
288	MB4-288(*)	8.495	8.175	.590	7.240
292	MB4-292(*)	8.595	8.275	.590	7.340
296	MB4-296(*)	8.695	8.375	.590	7.440
300	MB4-300(*)	8.795	8.475	.590	7.540
304	MB4-304(*)	8.895	8.575	.590	7.640
308	MB4-308(*)	8.995	8.675	.590	7.740
312	MB4-312(*)	9.095	8.775	.590	7.840
316	MB4-316(*)	9.195	8.875	.590	7.940
320	MB4-320(*)	9.295	8.975	.590	8.040
324	MB4-324(*)	9.395	9.075	.590	8.140
328	MB4-328(*)	9.495	9.175	.590	8.240
332	MB4-332(*)	9.595	9.275	.590	8.340
336	MB4-336(*)	9.695	9.375	.590	8.440
340	MB4-340(*)	9.795	9.475	.590	8.540
344	MB4-344(*)	9.895	9.575	.590	8.640
348	MB4-348(*)	9.995	9.675	.590	8.740
352	MB4-352(*)	10.095	9.775	.590	8.840
356	MB4-356(*)	10.195	9.875	.590	8.940
360	MB4-360(*)	10.295	9.975	.590	9.040
364	MB4-364(*)	10.395	10.075	.590	9.140
368	MB4-368(*)	10.495	10.175	.590	9.240
372	MB4-372(*)	10.595	10.275	.590	9.340
376	MB4-376(*)	10.695	10.375	.590	9.440
380	MB4-380(*)	10.795	10.475	.590	9.540
384	MB4-384(*)	10.895	10.575	.590	9.640
388	MB4-388(*)	10.995	10.675	.590	9.740
392	MB4-392(*)	11.095	10.775	.590	9.840
396	MB4-396(*)	11.195	10.875	.590	9.940
400	MB4-400(*)	11.295	10.975	.590	10.040

\*See How to Order, pages 3, 4 and 5.

# Low Mating Force daughter board connector

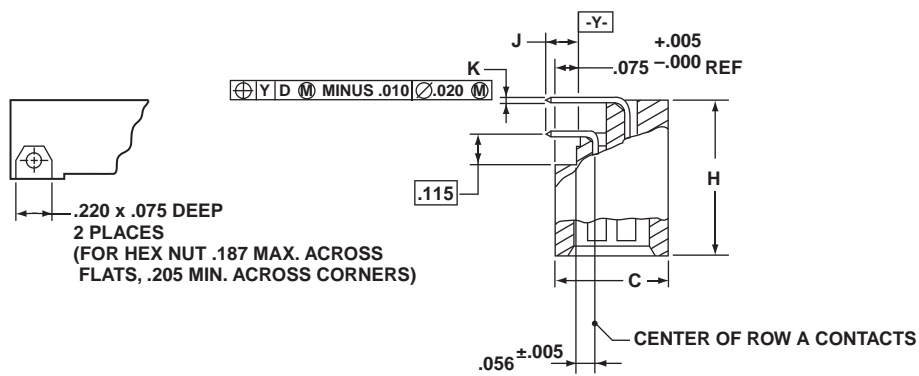
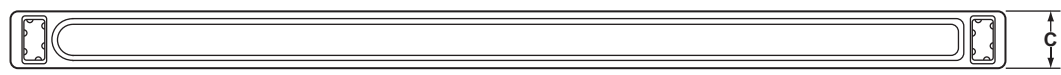
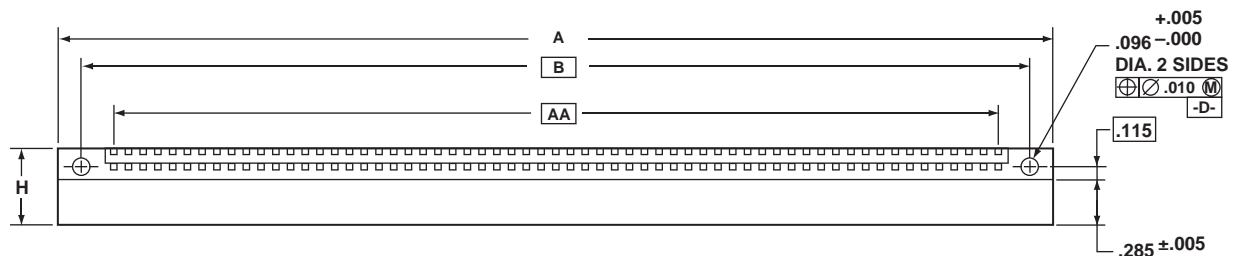
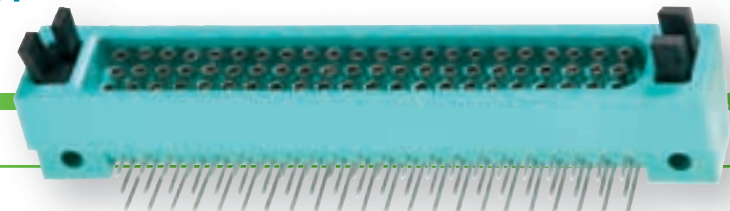

### MATES WITH MB AND PC SERIES CONNECTORS

Notes:  
When mating with MB or PC connector, a total of .035 inch minimum radial pilot is available for connector body alignment.

All dimensions for reference only.  
Polarization keys are not supplied as part of DB Connector Series assemblies. See Accessories How to Order, page 5 and further description, page 24.

□ Designates Basic Dimension

Contact Data				
Description	Termination Style Letter	Arrangement Row	J ±.020	K ±.002
Round PCB Stud, 90° Solder Termination	P	A	.085	.021 Dia.
	P	B	.085	.021 Dia.
	P	C	.085	.021 Dia.
	P	D	.085	.021 Dia.
	P-(705)	A	.120	.021 Dia.
	P-(705)	B	.120	.021 Dia.
	P-(705)	C	.120	.021 Dia.
	P-(705)	D	.120	.021 Dia.
	P-(709)	A	.300	.021 Dia.
	P-(709)	B	.300	.021 Dia.
P-(709)	C	.300	.021 Dia.	
P-(709)	D	.300	.021 Dia.	

NOTE: Other variations available - see pages 4 and 5, or consult Amphenol Aerospace.



# Low Mating Force daughter board connector 2 row contact arrangements

Number of Contacts	DB Number*	A Max.	B	C Max.	H Max.	AA
020	DB2-020P	1.680	1.350	.375	.545	.900
022	DB2-022P	1.780	1.450	.375	.545	1.000
024	DB2-024P	1.880	1.550	.375	.545	1.100
026	DB2-026P	1.980	1.650	.375	.545	1.200
028	DB2-028P	2.080	1.750	.375	.545	1.300
030	DB2-030P	2.180	1.850	.375	.545	1.400
032	DB2-032P	2.280	1.950	.375	.545	1.500
034	DB2-034P	2.380	2.050	.375	.545	1.600
036	DB2-036P	2.480	2.150	.375	.545	1.700
038	DB2-038P	2.580	2.250	.375	.545	1.800
040	DB2-040P	2.680	2.350	.375	.545	1.900
042	DB2-042P	2.780	2.450	.375	.545	2.000
044	DB2-044P	2.880	2.550	.375	.545	2.100
046	DB2-046P	2.980	2.650	.375	.545	2.200
048	DB2-048P	3.080	2.750	.375	.545	2.300
050	DB2-050P	3.180	2.850	.375	.545	2.400
052	DB2-052P	3.280	2.950	.375	.545	2.500
054	DB2-054P	3.380	3.050	.375	.545	2.600
056	DB2-056P	3.480	3.150	.375	.545	2.700
058	DB2-058P	3.580	3.250	.375	.545	2.800
060	DB2-060P	3.680	3.350	.375	.545	2.900
062	DB2-062P	3.780	3.450	.375	.545	3.000
064	DB2-064P	3.880	3.550	.375	.545	3.100
066	DB2-066P	3.980	3.650	.375	.545	3.200
068	DB2-068P	4.080	3.750	.375	.545	3.300
070	DB2-070P	4.180	3.850	.375	.545	3.400
072	DB2-072P	4.280	3.950	.375	.545	3.500
074	DB2-074P	4.380	4.050	.375	.545	3.600
076	DB2-076P	4.480	4.150	.375	.545	3.700
078	DB2-078P	4.580	4.250	.375	.545	3.800
080	DB2-080P	4.680	4.350	.375	.545	3.900
082	DB2-082P	4.780	4.450	.375	.545	4.000
084	DB2-084P	4.880	4.550	.375	.545	4.100
086	DB2-086P	4.980	4.650	.375	.545	4.200
088	DB2-088P	5.080	4.750	.375	.545	4.300
090	DB2-090P	5.180	4.850	.375	.545	4.400
092	DB2-092P	5.280	4.950	.375	.545	4.500
094	DB2-094P	5.380	5.050	.375	.545	4.600
096	DB2-096P	5.480	5.150	.375	.545	4.700
098	DB2-098P	5.580	5.250	.375	.545	4.800
100	DB2-100P	5.680	5.350	.375	.545	4.900
102	DB2-102P	5.780	5.450	.375	.545	5.000
104	DB2-104P	5.880	5.550	.375	.545	5.100
106	DB2-106P	5.980	5.650	.375	.545	5.200
108	DB2-108P	6.080	5.750	.375	.545	5.300
110	DB2-110P	6.180	5.850	.375	.545	5.400

Number of Contacts	DB Number*	A Max.	B	C Max.	H Max.	AA
112	DB2-112P	6.280	5.950	.375	.545	5.500
114	DB2-114P	6.380	6.050	.375	.545	5.600
116	DB2-116P	6.480	6.150	.375	.545	5.700
118	DB2-118P	6.580	6.250	.375	.545	5.800
120	DB2-120P	6.680	6.350	.375	.545	5.900
122	DB2-122P	6.780	6.450	.375	.545	6.000
124	DB2-124P	6.880	6.550	.375	.545	6.100
126	DB2-126P	6.980	6.650	.375	.545	6.200
128	DB2-128P	7.080	6.750	.375	.545	6.300
130	DB2-130P	7.180	6.850	.375	.545	6.400
132	DB2-132P	7.280	6.950	.375	.545	6.500
134	DB2-134P	7.380	7.050	.375	.545	6.600
136	DB2-136P	7.480	7.150	.375	.545	6.700
138	DB2-138P	7.580	7.250	.375	.545	6.800
140	DB2-140P	7.680	7.350	.375	.545	6.900
142	DB2-142P	7.780	7.450	.375	.545	7.000
144	DB2-144P	7.880	7.550	.375	.545	7.100
146	DB2-146P	7.980	7.650	.375	.545	7.200
148	DB2-148P	8.080	7.750	.375	.545	7.300
150	DB2-150P	8.180	7.850	.375	.545	7.400
152	DB2-152P	8.280	7.950	.375	.545	7.500
154	DB2-154P	8.380	8.050	.375	.545	7.600
156	DB2-156P	8.480	8.150	.375	.545	7.700
158	DB2-158P	8.580	8.250	.375	.545	7.800
160	DB2-160P	8.680	8.350	.375	.545	7.900
162	DB2-162P	8.780	8.450	.375	.545	8.000
164	DB2-164P	8.880	8.550	.375	.545	8.100
166	DB2-166P	8.980	8.650	.375	.545	8.200
168	DB2-168P	9.080	8.750	.375	.545	8.300
170	DB2-170P	9.180	8.850	.375	.545	8.400
172	DB2-172P	9.280	8.950	.375	.545	8.500
174	DB2-174P	9.380	9.050	.375	.545	8.600
176	DB2-176P	9.480	9.150	.375	.545	8.700
178	DB2-178P	9.580	9.250	.375	.545	8.800
180	DB2-180P	9.680	9.350	.375	.545	8.900
182	DB2-182P	9.780	9.450	.375	.545	9.000
184	DB2-184P	9.880	9.550	.375	.545	9.100
186	DB2-186P	9.980	9.650	.375	.545	9.200
188	DB2-188P	10.080	9.750	.375	.545	9.300
190	DB2-190P	10.180	9.850	.375	.545	9.400
192	DB2-192P	10.280	9.950	.375	.545	9.500
194	DB2-194P	10.380	10.050	.375	.545	9.600
196	DB2-196P	10.480	10.150	.375	.545	9.700
198	DB2-198P	10.580	10.250	.375	.545	9.800
200	DB2-200P	10.680	10.350	.375	.545	9.900

\*See How to Order, pages 3, 4 and 5

# Low Mating Force daughter board connector 3 row contact arrangements

Number of Contacts	DB Number*	A Max.	B	C Max.	H Max.	AA
030	DB3-030P	1.680	1.350	.475	.645	.900
033	DB3-033P	1.780	1.450	.475	.645	1.000
036	DB3-036P	1.880	1.550	.475	.645	1.100
039	DB3-039P	1.980	1.650	.475	.645	1.200
042	DB3-042P	2.080	1.750	.475	.645	1.300
045	DB3-045P	2.180	1.850	.475	.645	1.400
048	DB3-048P	2.280	1.950	.475	.645	1.500
051	DB3-051P	2.380	2.050	.475	.645	1.600
054	DB3-054P	2.480	2.150	.475	.645	1.700
057	DB3-057P	2.580	2.250	.475	.645	1.800
060	DB3-060P	2.680	2.350	.475	.645	1.900
063	DB3-063P	2.780	2.450	.475	.645	2.000
066	DB3-066P	2.880	2.550	.475	.645	2.100
069	DB3-069P	2.980	2.650	.475	.645	2.200
072	DB3-072P	3.080	2.750	.475	.645	2.300
075	DB3-075P	3.180	2.850	.475	.645	2.400
078	DB3-078P	3.280	2.950	.475	.645	2.500
081	DB3-081P	3.380	3.050	.475	.645	2.600
084	DB3-084P	3.480	3.150	.475	.645	2.700
087	DB3-087P	3.580	3.250	.475	.645	2.800
090	DB3-090P	3.680	3.350	.475	.645	2.900
093	DB3-093P	3.780	3.450	.475	.645	3.000
096	DB3-096P	3.880	3.550	.475	.645	3.100
099	DB3-099P	3.980	3.650	.475	.645	3.200
102	DB3-102P	4.080	3.750	.475	.645	3.300
105	DB3-105P	4.180	3.850	.475	.645	3.400
108	DB3-108P	4.280	3.950	.475	.645	3.500
111	DB3-111P	4.380	4.050	.475	.645	3.600
114	DB3-114P	4.480	4.150	.475	.645	3.700
117	DB3-117P	4.580	4.250	.475	.645	3.800
120	DB3-120P	4.680	4.350	.475	.645	3.900
123	DB3-123P	4.780	4.450	.475	.645	4.000
126	DB3-126P	4.880	4.550	.475	.645	4.100
129	DB3-129P	4.980	4.650	.475	.645	4.200
132	DB3-132P	5.080	4.750	.475	.645	4.300
135	DB3-135P	5.180	4.850	.475	.645	4.400
138	DB3-138P	5.280	4.950	.475	.645	4.500
141	DB3-141P	5.380	5.050	.475	.645	4.600
144	DB3-144P	5.480	5.150	.475	.645	4.700
147	DB3-147P	5.580	5.250	.475	.645	4.800
150	DB3-150P	5.680	5.350	.475	.645	4.900
153	DB3-153P	5.780	5.450	.475	.645	5.000
156	DB3-156P	5.880	5.550	.475	.645	5.100
159	DB3-159P	5.980	5.650	.475	.645	5.200
162	DB3-162P	6.080	5.750	.475	.645	5.300
165	DB3-165P	6.180	5.850	.475	.645	5.400

Number of Contacts	DB Number*	A Max.	B	C Max.	H Max.	AA
168	DB3-168P	6.280	5.950	.475	.645	5.500
171	DB3-171P	6.380	6.050	.475	.645	5.600
174	DB3-174P	6.480	6.150	.475	.645	5.700
177	DB3-177P	6.580	6.250	.475	.645	5.800
180	DB3-180P	6.680	6.350	.475	.645	5.900
183	DB3-183P	6.780	6.450	.475	.645	6.000
186	DB3-186P	6.880	6.550	.475	.645	6.100
189	DB3-189P	6.980	6.650	.475	.645	6.200
192	DB3-192P	7.080	6.750	.475	.645	6.300
195	DB3-195P	7.180	6.850	.475	.645	6.400
198	DB3-198P	7.280	6.950	.475	.645	6.500
201	DB3-201P	7.380	7.050	.475	.645	6.600
204	DB3-204P	7.480	7.150	.475	.645	6.700
207	DB3-207P	7.580	7.250	.475	.645	6.800
210	DB3-210P	7.680	7.350	.475	.645	6.900
213	DB3-213P	7.780	7.450	.475	.645	7.000
216	DB3-216P	7.880	7.550	.475	.645	7.100
219	DB3-219P	7.980	7.650	.475	.645	7.200
222	DB3-222P	8.080	7.750	.475	.645	7.300
225	DB3-225P	8.180	7.850	.475	.645	7.400
228	DB3-228P	8.280	7.950	.475	.645	7.500
231	DB3-231P	8.380	8.050	.475	.645	7.600
234	DB3-234P	8.480	8.150	.475	.645	7.700
237	DB3-237P	8.580	8.250	.475	.645	7.800
240	DB3-240P	8.680	8.350	.475	.645	7.900
243	DB3-243P	8.780	8.450	.475	.645	8.000
246	DB3-246P	8.880	8.550	.475	.645	8.100
249	DB3-249P	8.980	8.650	.475	.645	8.200
252	DB3-252P	9.080	8.750	.475	.645	8.300
255	DB3-255P	9.180	8.850	.475	.645	8.400
258	DB3-258P	9.280	8.950	.475	.645	8.500
261	DB3-261P	9.380	9.050	.475	.645	8.600
264	DB3-264P	9.480	9.150	.475	.645	8.700
267	DB3-267P	9.580	9.250	.475	.645	8.800
270	DB3-270P	9.680	9.350	.475	.645	8.900
273	DB3-273P	9.780	9.450	.475	.645	9.000
276	DB3-276P	9.880	9.550	.475	.645	9.100
279	DB3-279P	9.980	9.650	.475	.645	9.200
282	DB3-282P	10.080	9.750	.475	.645	9.300
285	DB3-285P	10.180	9.850	.475	.645	9.400
288	DB3-288P	10.280	9.950	.475	.645	9.500
291	DB3-291P	10.380	10.050	.475	.645	9.600
294	DB3-294P	10.480	10.150	.475	.645	9.700
297	DB3-397P	10.580	10.250	.475	.645	9.800
300	DB3-300P	10.680	10.350	.475	.645	9.900

\*See How to Order, pages 3, 4 and 5

# Low Mating Force

## daughter board connector

### 4 row contact arrangements

Number of Contacts	DB Number*	A Max.	B	C Max.	H Max.	AA
040	DB4-040P	1.680	1.350	.575	.745	.900
044	DB4-044P	1.780	1.450	.575	.745	1.000
048	DB4-048P	1.880	1.550	.575	.745	1.100
052	DB4-052P	1.980	1.650	.575	.745	1.200
056	DB4-056P	2.080	1.750	.575	.745	1.300
060	DB4-060P	2.180	1.850	.575	.745	1.400
064	DB4-064P	2.280	1.950	.575	.745	1.500
068	DB4-068P	2.380	2.050	.575	.745	1.600
072	DB4-072P	2.480	2.150	.575	.745	1.700
076	DB4-076P	2.580	2.250	.575	.745	1.800
080	DB4-080P	2.680	2.350	.575	.745	1.900
084	DB4-084P	2.780	2.450	.575	.745	2.000
088	DB4-088P	2.880	2.550	.575	.745	2.100
092	DB4-092P	2.980	2.650	.575	.745	2.200
096	DB4-096P	3.080	2.750	.575	.745	2.300
100	DB4-100P	3.180	2.850	.575	.745	2.400
104	DB4-104P	3.280	2.950	.575	.745	2.500
108	DB4-108P	3.380	3.050	.575	.745	2.600
112	DB4-112P	3.480	3.150	.575	.745	2.700
116	DB4-116P	3.580	3.250	.575	.745	2.800
120	DB4-120P	3.680	3.350	.575	.745	2.900
124	DB4-124P	3.780	3.450	.575	.745	3.000
128	DB4-128P	3.880	3.550	.575	.745	3.100
132	DB4-132P	3.980	3.650	.575	.745	3.200
136	DB4-136P	4.080	3.750	.575	.745	3.300
140	DB4-140P	4.180	3.850	.575	.745	3.400
144	DB4-144P	4.280	3.950	.575	.745	3.500
148	DB4-148P	4.380	4.050	.575	.745	3.600
152	DB4-152P	4.480	4.150	.575	.745	3.700
156	DB4-156P	4.580	4.250	.575	.745	3.800
160	DB4-160P	4.680	4.350	.575	.745	3.900
164	DB4-164P	4.780	4.450	.575	.745	4.000
168	DB4-168P	4.880	4.550	.575	.745	4.100
172	DB4-172P	4.980	4.650	.575	.745	4.200
176	DB4-176P	5.080	4.750	.575	.745	4.300
180	DB4-180P	5.180	4.850	.575	.745	4.400
184	DB4-184P	5.280	4.950	.575	.745	4.500
188	DB4-188P	5.380	5.050	.575	.745	4.600
192	DB4-192P	5.480	5.150	.575	.745	4.700
196	DB4-196P	5.580	5.250	.575	.745	4.800
200	DB4-200P	5.680	5.350	.575	.745	4.900
204	DB4-204P	5.780	5.450	.575	.745	5.000
208	DB4-208P	5.880	5.550	.575	.745	5.100
212	DB4-212P	5.980	5.650	.575	.745	5.200
216	DB4-216P	6.080	5.750	.575	.745	5.300
220	DB4-220P	6.180	5.850	.575	.745	5.400

Number of Contacts	DB Number*	A Max.	B	C Max.	H Max.	AA
224	DB4-224P	6.280	5.950	.575	.745	5.500
228	DB4-228P	6.380	6.050	.575	.745	5.600
232	DB4-232P	6.480	6.150	.575	.745	5.700
236	DB4-236P	6.580	6.250	.575	.745	5.800
240	DB4-240P	6.680	6.350	.575	.745	5.900
244	DB4-244P	6.780	6.450	.575	.745	6.000
248	DB4-248P	6.880	6.550	.575	.745	6.100
252	DB4-252P	6.980	6.650	.575	.745	6.200
256	DB4-256P	7.080	6.750	.575	.745	6.300
260	DB4-260P	7.180	6.850	.575	.745	6.400
264	DB4-264P	7.280	6.950	.575	.745	6.500
268	DB4-268P	7.380	7.050	.575	.745	6.600
272	DB4-272P	7.480	7.150	.575	.745	6.700
276	DB4-276P	7.580	7.250	.575	.745	6.800
280	DB4-280P	7.680	7.350	.575	.745	6.900
284	DB4-284P	7.780	7.450	.575	.745	7.000
288	DB4-288P	7.880	7.550	.575	.745	7.100
292	DB4-292P	7.980	7.650	.575	.745	7.200
296	DB4-296P	8.080	7.750	.575	.745	7.300
300	DB4-300P	8.180	7.850	.575	.745	7.400
304	DB4-304P	8.280	7.950	.575	.745	7.500
308	DB4-308P	8.380	8.050	.575	.745	7.600
312	DB4-312P	8.480	8.150	.575	.745	7.700
316	DB4-316P	8.580	8.250	.575	.745	7.800
320	DB4-320P	8.680	8.350	.575	.745	7.900
324	DB4-324P	8.780	8.450	.575	.745	8.000
328	DB4-328P	8.880	8.550	.575	.745	8.100
332	DB4-332P	8.980	8.650	.575	.745	8.200
336	DB4-336P	9.080	8.750	.575	.745	8.300
340	DB4-340P	9.180	8.850	.575	.745	8.400
344	DB4-344P	9.280	8.950	.575	.745	8.500
348	DB4-348P	9.380	9.050	.575	.745	8.600
352	DB4-352P	9.480	9.150	.575	.745	8.700
356	DB4-356P	9.580	9.250	.575	.745	8.800
360	DB4-360P	9.680	9.350	.575	.745	8.900
364	DB4-364P	9.780	9.450	.575	.745	9.000
368	DB4-368P	9.880	9.550	.575	.745	9.100
372	DB4-372P	9.980	9.650	.575	.745	9.200
376	DB4-376P	10.080	9.750	.575	.745	9.300
380	DB4-380P	10.180	9.850	.575	.745	9.400
384	DB4-384P	10.280	9.950	.575	.745	9.500
388	DB4-388P	10.380	10.050	.575	.745	9.600
392	DB4-392P	10.480	10.150	.575	.745	9.700
396	DB4-396P	10.580	10.250	.575	.745	9.800
400	DB4-400P	10.680	10.350	.575	.745	9.900

\*See How to Order, pages 3, 4 and 5

# Low Mating Force input/output connector

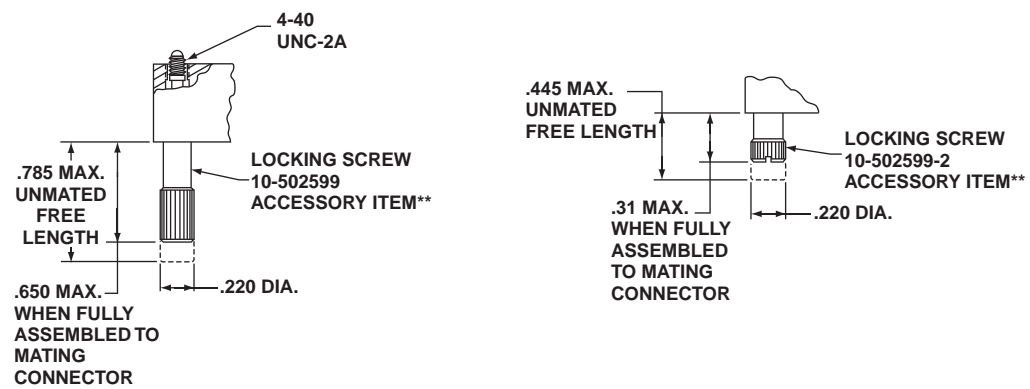
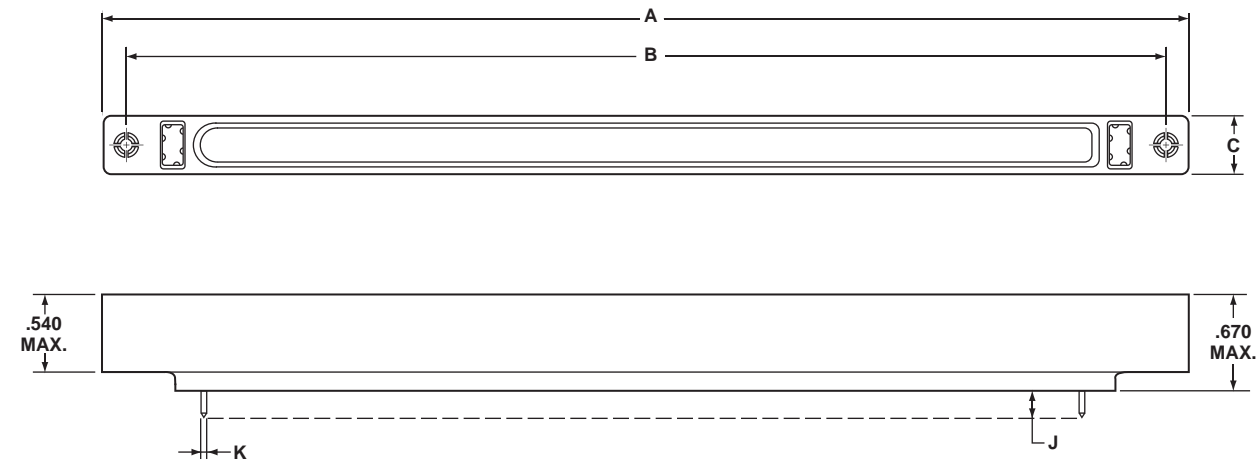

## MATES WITH MB AND PC SERIES CONNECTORS

### Notes:

When mating with MB or PC connector, a total of .022 inch minimum radial pilot is available for connector body alignment.

All dimensions for reference only.

Crimp contact, wire well size 22D, supplied with IO Connector Series assemblies. Optional noble metal termination plating available. See How to Order, page 5.

Polarization keys are not supplied as part of IO Connector Series assemblies. See Accessories How to Order, page 5 and further description, page 24.

\*\* Locking Screws are not supplied as part of IO Connector Series assemblies. See Accessories How to Order, page 5 and further description, page 29.

Description	Contact Data		
	Termination Style Letter	J ±.020	K ±.002
Rear Removable Crimp Contact	C	N/A	N/A
Round PCB Stud Solder Termination	P	.145	.021
	P-(713)	.060	.021
	P-(709)	.335	.021

NOTE: Other variations available - see pages 4 and 5, or consult Amphenol Aerospace.

# Low Mating Force input/output connector 2 row contact arrangements

Number of Contacts	IO Number*	A Max.	B	C Max.
020	IO2-020(*)	2.295	1.975	.390
022	IO2-022(*)	2.395	2.075	.390
024	IO2-024(*)	2.495	2.175	.390
026	IO2-026(*)	2.595	2.275	.390
028	IO2-028(*)	2.695	2.375	.390
030	IO2-030(*)	2.795	2.475	.390
032	IO2-032(*)	2.895	2.575	.390
034	IO2-034(*)	2.995	2.675	.390
036	IO2-036(*)	3.095	2.775	.390
038	IO2-038(*)	3.195	2.875	.390
040	IO2-040(*)	3.295	2.975	.390
042	IO2-042(*)	3.395	3.075	.390
044	IO2-044(*)	3.495	3.175	.390
046	IO2-046(*)	3.595	3.275	.390
048	IO2-048(*)	3.695	3.375	.390
050	IO2-050(*)	3.795	3.475	.390
052	IO2-052(*)	3.895	3.575	.390
054	IO2-054(*)	3.995	3.675	.390
056	IO2-056(*)	4.095	3.775	.390
058	IO2-058(*)	4.195	3.875	.390
060	IO2-060(*)	4.295	3.975	.390
062	IO2-062(*)	4.395	4.075	.390
064	IO2-064(*)	4.495	4.175	.390
066	IO2-066(*)	4.595	4.275	.390
068	IO2-068(*)	4.695	4.375	.390
070	IO2-070(*)	4.795	4.475	.390
072	IO2-072(*)	4.895	4.575	.390
074	IO2-074(*)	4.995	4.675	.390
076	IO2-076(*)	5.095	4.775	.390
078	IO2-078(*)	5.195	4.875	.390
080	IO2-080(*)	5.295	4.975	.390
082	IO2-082(*)	5.395	5.075	.390
084	IO2-084(*)	5.495	5.175	.390
086	IO2-086(*)	5.595	5.275	.390
088	IO2-088(*)	5.695	5.375	.390
090	IO2-090(*)	5.795	5.475	.390
092	IO2-092(*)	5.895	5.575	.390
094	IO2-094(*)	5.995	5.675	.390
096	IO2-096(*)	6.095	5.775	.390
098	IO2-098(*)	6.195	5.875	.390
100	IO2-100(*)	6.295	5.975	.390
102	IO2-102(*)	6.395	6.075	.390
104	IO2-104(*)	6.495	6.175	.390
106	IO2-106(*)	6.595	6.275	.390
108	IO2-108(*)	6.695	6.375	.390
110	IO2-110(*)	6.795	6.475	.390

Number of Contacts	IO Number*	A Max.	B	C Max.
112	IO2-112(*)	6.895	6.575	.390
114	IO2-114(*)	6.995	6.675	.390
116	IO2-116(*)	7.095	6.775	.390
118	IO2-118(*)	7.195	6.875	.390
120	IO2-120(*)	7.295	6.975	.390
122	IO2-122(*)	7.395	7.075	.390
124	IO2-124(*)	7.495	7.175	.390
126	IO2-126(*)	7.595	7.275	.390
128	IO2-128(*)	7.695	7.375	.390
130	IO2-130(*)	7.795	7.475	.390
132	IO2-132(*)	7.895	7.575	.390
134	IO2-134(*)	7.995	7.675	.390
136	IO2-136(*)	8.095	7.775	.390
138	IO2-138(*)	8.195	7.875	.390
140	IO2-140(*)	8.295	7.975	.390
142	IO2-142(*)	8.395	8.075	.390
144	IO2-144(*)	8.495	8.175	.390
146	IO2-146(*)	8.595	8.275	.390
148	IO2-148(*)	8.695	8.375	.390
150	IO2-150(*)	8.795	8.475	.390
152	IO2-152(*)	8.895	8.575	.390
154	IO2-154(*)	8.995	8.675	.390
156	IO2-156(*)	9.095	8.775	.390
158	IO2-158(*)	9.195	8.875	.390
160	IO2-160(*)	9.295	8.975	.390
162	IO2-162(*)	9.395	9.075	.390
164	IO2-164(*)	9.495	9.175	.390
166	IO2-166(*)	9.595	9.275	.390
168	IO2-168(*)	9.695	9.375	.390
170	IO2-170(*)	9.795	9.475	.390
172	IO2-172(*)	9.895	9.575	.390
174	IO2-174(*)	9.995	9.675	.390
176	IO2-176(*)	10.095	9.775	.390
178	IO2-178(*)	10.195	9.875	.390
180	IO2-180(*)	10.295	9.975	.390
182	IO2-182(*)	10.395	10.075	.390
184	IO2-184(*)	10.495	10.175	.390
186	IO2-186(*)	10.595	10.275	.390
188	IO2-188(*)	10.695	10.375	.390
190	IO2-190(*)	10.795	10.475	.390
192	IO2-192(*)	10.895	10.575	.390
194	IO2-194(*)	10.995	10.675	.390
196	IO2-196(*)	11.095	10.775	.390
198	IO2-198(*)	11.195	10.875	.390
200	IO2-200(*)	11.295	10.975	.390

\*See How to Order, pages 3, 4 and 5

# Low Mating Force input/output connector 3 row contact arrangements

Number of Contacts	IO Number*	A Max.	B	C Max.
030	IO3-030(*)	2.295	1.975	.490
033	IO3-033(*)	2.395	2.075	.490
036	IO3-036(*)	2.495	2.175	.490
039	IO3-039(*)	2.595	2.275	.490
042	IO3-042(*)	2.695	2.375	.490
045	IO3-045(*)	2.795	2.475	.490
048	IO3-048(*)	2.894	2.575	.490
051	IO3-051(*)	2.995	2.675	.490
054	IO3-054(*)	3.095	2.775	.490
057	IO3-057(*)	3.195	2.875	.490
060	IO3-060(*)	3.295	2.975	.490
063	IO3-063(*)	3.395	3.075	.490
066	IO3-066(*)	3.495	3.175	.490
069	IO3-069(*)	3.595	3.275	.490
072	IO3-072(*)	3.695	3.375	.490
075	IO3-075(*)	3.795	3.475	.490
078	IO3-078(*)	3.895	3.575	.490
081	IO3-081(*)	3.995	3.675	.490
084	IO3-084(*)	4.095	3.775	.490
087	IO3-087(*)	4.195	3.875	.490
090	IO3-090(*)	4.295	3.975	.490
093	IO3-093(*)	4.395	4.075	.490
096	IO3-096(*)	4.495	4.175	.490
099	IO3-099(*)	4.595	4.275	.490
102	IO3-102(*)	4.695	4.375	.490
105	IO3-105(*)	4.795	4.475	.490
108	IO3-108(*)	4.895	4.575	.490
111	IO3-111(*)	4.995	4.675	.490
114	IO3-114(*)	5.095	4.775	.490
117	IO3-117(*)	5.195	4.875	.490
120	IO3-120(*)	5.295	4.975	.490
123	IO3-123(*)	5.395	5.075	.490
126	IO3-126(*)	5.495	5.175	.490
129	IO3-129(*)	5.595	5.275	.490
132	IO3-132(*)	5.695	5.375	.490
135	IO3-135(*)	5.795	5.475	.490
138	IO3-138(*)	5.895	5.575	.490
141	IO3-141(*)	5.995	5.675	.490
144	IO3-144(*)	6.095	5.775	.490
147	IO3-147(*)	6.195	5.875	.490
150	IO3-150(*)	6.295	5.975	.490
153	IO3-153(*)	6.395	6.075	.490
156	IO3-156(*)	6.495	6.175	.490
159	IO3-159(*)	6.595	6.275	.490
162	IO3-162(*)	6.695	6.375	.490
165	IO3-165(*)	6.795	6.475	.490

Number of Contacts	IO Number*	A Max.	B	C Max.
168	IO3-168(*)	6.895	6.575	.490
171	IO3-171(*)	6.995	6.675	.490
174	IO3-174(*)	7.095	6.775	.490
177	IO3-177(*)	7.195	6.875	.490
180	IO3-180(*)	7.295	6.975	.490
183	IO3-183(*)	7.395	7.075	.490
186	IO3-186(*)	7.495	7.175	.490
189	IO3-189(*)	7.595	7.275	.490
192	IO3-192(*)	7.695	7.375	.490
195	IO3-195(*)	7.795	7.475	.490
198	IO3-198(*)	7.895	7.575	.490
201	IO3-201(*)	7.995	7.675	.490
204	IO3-204(*)	8.095	7.775	.490
207	IO3-207(*)	8.195	7.875	.490
210	IO3-210(*)	8.295	7.975	.490
213	IO3-213(*)	8.395	8.075	.490
216	IO3-216(*)	8.495	8.175	.490
219	IO3-219(*)	8.595	8.275	.490
222	IO3-222(*)	8.695	8.375	.490
225	IO3-225(*)	8.795	8.475	.490
228	IO3-228(*)	8.895	8.575	.490
231	IO3-231(*)	8.995	8.675	.490
234	IO3-234(*)	9.095	8.775	.490
237	IO3-237(*)	9.195	8.875	.490
240	IO3-240(*)	9.295	8.975	.490
243	IO3-243(*)	9.395	9.075	.490
246	IO3-246(*)	9.495	9.175	.490
249	IO3-249(*)	9.595	9.275	.490
252	IO3-252(*)	9.695	9.375	.490
255	IO3-255(*)	9.795	9.475	.490
258	IO3-258(*)	9.895	9.575	.490
261	IO3-261(*)	9.995	9.675	.490
264	IO3-264(*)	10.095	9.775	.490
267	IO3-267(*)	10.195	9.875	.490
270	IO3-270(*)	10.295	9.975	.490
273	IO3-273(*)	10.395	10.075	.490
276	IO3-276(*)	10.495	10.175	.490
279	IO3-279(*)	10.595	10.275	.490
282	IO3-282(*)	10.695	10.375	.490
285	IO3-285(*)	10.795	10.475	.490
288	IO3-288(*)	10.895	10.575	.490
291	IO3-291(*)	10.995	10.675	.490
294	IO3-294(*)	11.095	10.775	.490
297	IO3-297(*)	11.195	10.875	.490
300	IO3-300(*)	11.295	10.975	.490

\*See How to Order, pages 3, 4 and 5

# Low Mating Force input/output connector 4 row contact arrangements

Number of Contacts	IO Number*	A Max.	B	C Max.
040	IO4-040(*)	2.295	1.975	.590
044	IO4-044(*)	2.395	2.075	.590
048	IO4-048(*)	2.495	2.175	.590
052	IO4-052(*)	2.595	2.275	.590
056	IO4-056(*)	2.695	2.375	.590
060	IO4-060(*)	2.795	2.475	.590
064	IO4-064(*)	2.895	2.575	.590
068	IO4-068(*)	2.995	2.675	.590
072	IO4-072(*)	3.095	2.775	.590
076	IO4-076(*)	3.195	2.875	.590
080	IO4-080(*)	3.295	2.975	.590
084	IO4-084(*)	3.395	3.075	.590
088	IO4-088(*)	3.495	3.175	.590
092	IO4-092(*)	3.595	3.275	.590
096	IO4-096(*)	3.695	3.375	.590
100	IO4-100(*)	3.795	3.475	.590
104	IO4-104(*)	3.895	3.575	.590
108	IO4-108(*)	3.995	3.675	.590
112	IO4-112(*)	4.095	3.775	.590
116	IO4-116(*)	4.195	3.875	.590
120	IO4-120(*)	4.295	3.975	.590
124	IO4-124(*)	4.395	4.075	.590
128	IO4-128(*)	4.495	4.175	.590
132	IO4-132(*)	4.595	4.275	.590
136	IO4-136(*)	4.695	4.375	.590
140	IO4-140(*)	4.795	4.475	.590
144	IO4-144(*)	4.895	4.575	.590
148	IO4-148(*)	4.995	4.675	.590
152	IO4-152(*)	5.095	4.775	.590
156	IO4-156(*)	5.195	4.875	.590
160	IO4-160(*)	5.295	4.975	.590
164	IO4-164(*)	5.395	5.075	.590
168	IO4-168(*)	5.495	5.175	.590
172	IO4-172(*)	5.595	5.275	.590
176	IO4-176(*)	5.695	5.375	.590
180	IO4-180(*)	5.795	5.475	.590
184	IO4-184(*)	5.895	5.575	.590
188	IO4-188(*)	5.995	5.675	.590
192	IO4-192(*)	6.095	5.775	.590
196	IO4-196(*)	6.195	5.875	.590
200	IO4-200(*)	6.295	5.975	.590
204	IO4-204(*)	6.395	6.075	.590
208	IO4-208(*)	6.495	6.175	.590
212	IO4-212(*)	6.595	6.275	.590
216	IO4-216(*)	6.695	6.375	.590
220	IO4-220(*)	6.795	6.475	.590

Number of Contacts	IO Number*	A Max.	B	C Max.
224	IO4-224(*)	6.895	6.575	.590
228	IO4-228(*)	6.995	6.675	.590
232	IO4-232(*)	7.095	6.775	.590
236	IO4-236(*)	7.195	6.875	.590
240	IO4-240(*)	7.295	6.975	.590
244	IO4-244(*)	7.395	7.075	.590
248	IO4-248(*)	7.495	7.175	.590
252	IO4-252(*)	7.595	7.275	.590
256	IO4-256(*)	7.695	7.375	.590
260	IO4-260(*)	7.795	7.475	.590
264	IO4-264(*)	7.895	7.575	.590
268	IO4-268(*)	7.995	7.675	.590
272	IO4-272(*)	8.095	7.775	.590
276	IO4-276(*)	8.195	7.875	.590
280	IO4-280(*)	8.295	7.975	.590
284	IO4-284(*)	8.395	8.075	.590
288	IO4-288(*)	8.495	8.175	.590
292	IO4-292(*)	8.595	8.275	.590
296	IO4-296(*)	8.695	8.375	.590
300	IO4-300(*)	8.795	8.475	.590
304	IO4-304(*)	8.895	8.575	.590
308	IO4-308(*)	8.995	8.675	.590
312	IO4-312(*)	9.095	8.775	.590
316	IO4-316(*)	9.195	8.875	.590
320	IO4-320(*)	9.295	8.975	.590
324	IO4-324(*)	9.395	9.075	.590
328	IO4-328(*)	9.496	9.175	.590
332	IO4-332(*)	9.595	9.275	.590
336	IO4-336(*)	9.695	9.375	.590
340	IO4-340(*)	9.795	9.475	.590
344	IO4-344(*)	9.895	9.575	.590
348	IO4-348(*)	9.995	9.675	.590
352	IO4-352(*)	10.095	9.775	.590
356	IO4-356(*)	10.195	9.875	.590
360	IO4-360(*)	10.295	9.975	.590
364	IO4-364(*)	10.395	10.075	.590
368	IO4-368(*)	10.495	10.175	.590
372	IO4-372(*)	10.595	10.275	.590
376	IO4-376(*)	10.695	10.375	.590
380	IO4-380(*)	10.795	10.475	.590
384	IO4-384(*)	10.895	10.575	.590
388	IO4-388(*)	10.995	10.675	.590
392	IO4-392(*)	11.095	10.775	.590
396	IO4-396(*)	11.195	10.875	.590
400	IO4-400(*)	11.295	10.975	.590

\*See How to Order, pages 3, 4 and 5

# Low Mating Force PC connector

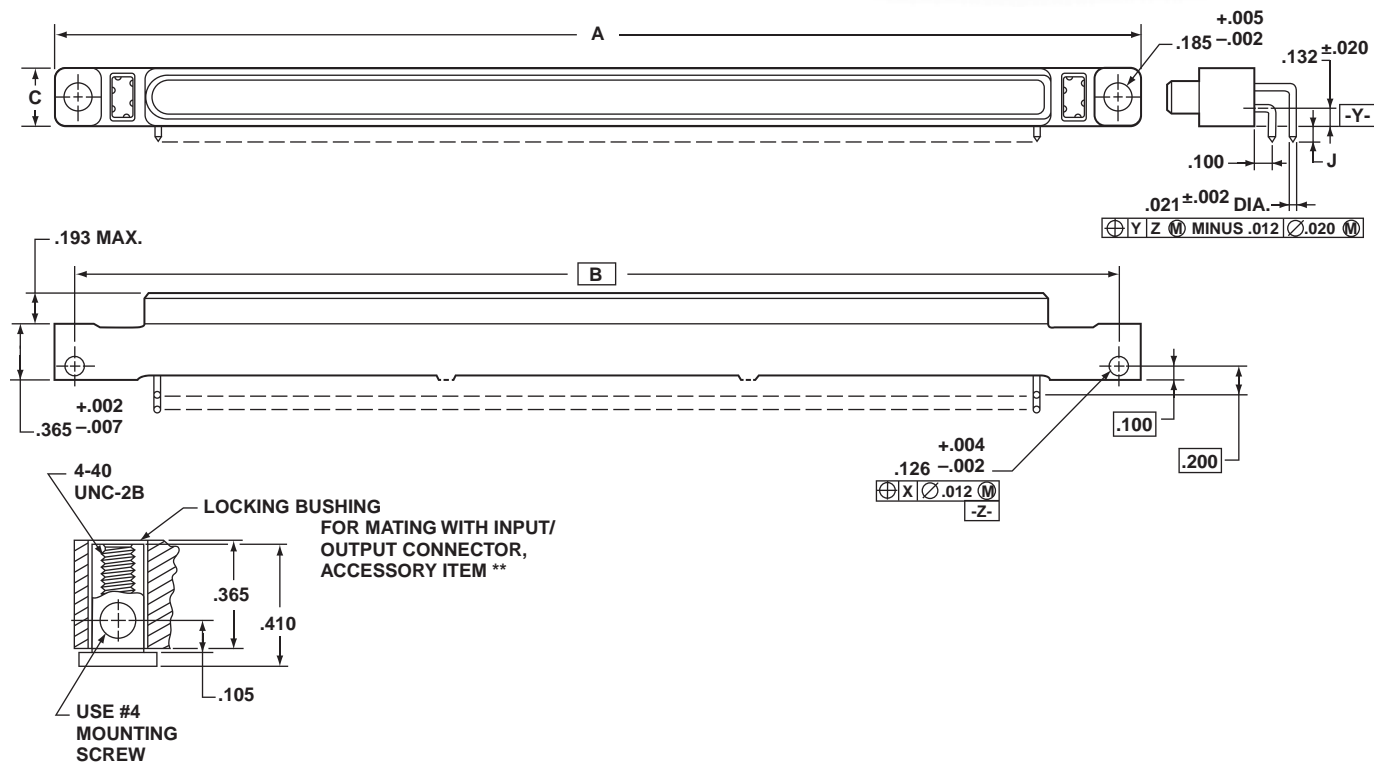

### MATES WITH DB AND IO SERIES CONNECTORS

Notes:  
 When mating with DB connector, a total of .035 inch minimum radial pilot is available for connector body alignment.  
 All dimensions for reference only.  
 Polarization keys are not supplied as part of PC Connector Series assemblies. See Accessories How to Order, page 5 and further description, page 24.  
 \*\* Locking bushings are not supplied as part of PC Connector Series assemblies. See Accessories How to Order, page 5, and further description, page 28.

Contact Data			
Description	Termination Style Letter	Arrangement Row	J +.035 - .025
Round PCB Stud, 90° Solder Termination	P	A	.095
	P	B	.095
	P	C	.095
	P	D	.095
	P-(714)	A	.150
	P-(714)	B	.150
	P-(714)	C	.150
	P-(714)	D	.150

NOTE: Other variations available - see pages 4 and 5, or consult Amphenol Aerospace.



# Low Mating Force PC connector 2 row contact arrangements

Number of Contacts	PC Number*	A Max.	B	C Max.
020	PC2-020P	2.295	1.975	.390
022	PC2-022P	2.395	2.075	.390
024	PC2-024P	2.495	2.175	.390
026	PC2-026P	2.595	2.275	.390
028	PC2-028P	2.695	2.375	.390
030	PC2-030P	2.795	2.475	.390
032	PC2-032P	2.895	2.575	.390
034	PC2-034P	2.995	2.675	.390
036	PC2-036P	3.095	2.775	.390
038	PC2-038P	3.195	2.875	.390
040	PC2-040P	3.295	2.975	.390
042	PC2-042P	3.395	3.075	.390
044	PC2-044P	3.495	3.175	.390
046	PC2-046P	3.595	3.275	.390
048	PC2-048P	3.695	3.375	.390
050	PC2-050P	3.795	3.475	.390
052	PC2-052P	3.895	3.575	.390
054	PC2-054P	3.995	3.675	.390
056	PC2-056P	4.095	3.775	.390
058	PC2-058P	4.195	3.875	.390
060	PC2-060P	4.295	3.975	.390
062	PC2-062P	4.395	4.075	.390
064	PC2-064P	4.495	4.175	.390
066	PC2-066P	4.595	4.275	.390
068	PC2-068P	4.695	4.375	.390
070	PC2-070P	4.795	4.475	.390
072	PC2-072P	4.895	4.575	.390
074	PC2-074P	4.995	4.675	.390
076	PC2-076P	5.095	4.775	.390
078	PC2-078P	5.195	4.875	.390
080	PC2-080P	5.295	4.975	.390
082	PC2-082P	5.395	5.075	.390
084	PC2-084P	5.495	5.175	.390
086	PC2-086P	5.595	5.275	.390
088	PC2-088P	5.695	5.375	.390
090	PC2-090P	5.795	5.475	.390
092	PC2-092P	5.895	5.575	.390
094	PC2-094P	5.995	5.675	.390
096	PC2-096P	6.095	5.775	.390
098	PC2-098P	6.195	5.875	.390
100	PC2-100P	6.295	5.975	.390
102	PC2-102P	6.395	6.075	.390
104	PC2-104P	6.495	6.175	.390
106	PC2-106P	6.595	6.275	.390
108	PC2-108P	6.695	6.375	.390
110	PC2-110P	6.795	6.475	.390

Number of Contacts	PC Number*	A Max.	B	C Max.
112	PC2-112P	6.895	6.575	.390
114	PC2-114P	6.995	6.675	.390
116	PC2-116P	7.095	6.775	.390
118	PC2-118P	7.195	6.875	.390
120	PC2-120P	7.295	6.975	.390
122	PC2-122P	7.395	7.075	.390
124	PC2-124P	7.495	7.175	.390
126	PC2-126P	7.595	7.275	.390
128	PC2-128P	7.695	7.375	.390
130	PC2-130P	7.795	7.475	.390
132	PC2-132P	7.895	7.575	.390
134	PC2-134P	7.995	7.675	.390
136	PC2-136P	8.095	7.775	.390
138	PC2-138P	8.195	7.875	.390
140	PC2-140P	8.295	7.975	.390
142	PC2-142P	8.395	8.075	.390
144	PC2-144P	8.495	8.175	.390
146	PC2-146P	8.595	8.275	.390
148	PC2-148P	8.695	8.375	.390
150	PC2-150P	8.795	8.475	.390
152	PC2-152P	8.895	8.575	.390
154	PC2-154P	8.995	8.675	.390
156	PC2-156P	9.095	8.775	.390
158	PC2-158P	9.195	8.875	.390
160	PC2-160P	9.295	8.975	.390
162	PC2-162P	9.395	9.075	.390
164	PC2-164P	9.495	9.175	.390
166	PC2-166P	9.595	9.275	.390
168	PC2-168P	9.695	9.375	.390
170	PC2-170P	9.795	9.475	.390
172	PC2-172P	9.895	9.575	.390
174	PC2-174P	9.995	9.675	.390
176	PC2-176P	10.095	9.775	.390
178	PC2-178P	10.195	9.875	.390
180	PC2-180P	10.295	9.975	.390
182	PC2-182P	10.395	10.075	.390
184	PC2-184P	10.495	10.175	.390
186	PC2-186P	10.595	10.275	.390
188	PC2-188P	10.695	10.375	.390
190	PC2-190P	10.795	10.475	.390
192	PC2-192P	10.895	10.575	.390
194	PC2-194P	10.995	10.675	.390
196	PC2-196P	11.095	10.775	.390
198	PC2-198P	11.195	10.875	.390
200	PC2-200P	11.295	10.975	.390

\*See How to Order, pages 3, 4 and 5

# Low Mating Force PC connector 3 row contact arrangements

Number of Contacts	PC Number*	A Max.	B	C Max.
030	PC3-030P	2.295	1.975	.490
033	PC3-033P	2.395	2.075	.490
036	PC3-036P	2.495	2.175	.490
039	PC3-039P	2.595	2.275	.490
042	PC3-042P	2.695	2.375	.490
045	PC3-045P	2.795	2.475	.490
048	PC3-048P	2.895	2.575	.490
051	PC3-051P	2.995	2.675	.490
054	PC3-054P	3.095	2.775	.490
057	PC3-057P	3.195	2.875	.490
060	PC3-060P	3.295	2.975	.490
063	PC3-063P	3.395	3.075	.490
066	PC3-066P	3.495	3.175	.490
069	PC3-069P	3.595	3.275	.490
072	PC3-072P	3.695	3.375	.490
075	PC3-075P	3.795	3.475	.490
078	PC3-078P	3.895	3.575	.490
081	PC3-081P	3.995	3.675	.490
084	PC3-084P	4.095	3.775	.490
087	PC3-087P	4.195	3.875	.490
090	PC3-090P	4.295	3.975	.490
093	PC3-093P	4.395	4.075	.490
096	PC3-096P	4.495	4.175	.490
099	PC3-099P	4.595	4.275	.490
102	PC3-102P	4.695	4.375	.490
105	PC3-105P	4.795	4.475	.490
108	PC3-108P	4.895	4.575	.490
111	PC3-111P	4.995	4.675	.490
114	PC3-114P	5.095	4.775	.490
117	PC3-117P	5.195	4.875	.490
120	PC3-120P	5.295	4.975	.490
123	PC3-123P	5.395	5.075	.490
126	PC3-126P	5.495	5.175	.490
129	PC3-129P	5.595	5.275	.490
132	PC3-132P	5.695	5.375	.490
135	PC3-135P	5.795	5.475	.490
138	PC3-138P	5.895	5.575	.490
141	PC3-141P	5.995	5.675	.490
144	PC3-144P	6.095	5.775	.490
147	PC3-147P	6.195	5.875	.490
150	PC3-150P	6.295	5.975	.490
153	PC3-153P	6.395	6.075	.490
156	PC3-156P	6.495	6.175	.490
159	PC3-159P	6.595	6.275	.490
162	PC3-162P	6.695	6.375	.490
165	PC3-165P	6.795	6.475	.490

Number of Contacts	PC Number*	A Max.	B	C Max.
168	PC3-168P	6.895	6.575	.490
171	PC3-171P	6.995	6.675	.490
174	PC3-174P	7.095	6.775	.490
177	PC3-177P	7.195	6.875	.490
180	PC3-180P	7.295	6.975	.490
183	PC3-183P	7.395	7.075	.490
186	PC3-186P	7.495	7.175	.490
189	PC3-189P	7.595	7.275	.490
192	PC3-192P	7.695	7.375	.490
195	PC3-195P	7.795	7.475	.490
198	PC3-198P	7.895	7.575	.490
201	PC3-201P	7.995	7.675	.490
204	PC3-204P	8.095	7.775	.490
207	PC3-207P	8.195	7.875	.490
210	PC3-210P	8.295	7.975	.490
213	PC3-213P	8.395	8.075	.490
216	PC3-216P	8.495	8.175	.490
219	PC3-219P	8.595	8.275	.490
222	PC3-222P	8.695	8.375	.490
225	PC3-225P	8.795	8.475	.490
228	PC3-228P	8.895	8.575	.490
231	PC3-231P	8.995	8.675	.490
234	PC3-234P	9.095	8.775	.490
237	PC3-237P	9.195	8.875	.490
240	PC3-240P	9.295	8.975	.490
243	PC3-243P	9.395	9.075	.490
246	PC3-246P	9.495	9.175	.490
249	PC3-249P	9.595	9.275	.490
252	PC3-252P	9.695	9.375	.490
255	PC3-255P	9.795	9.475	.490
258	PC3-258P	9.895	9.575	.490
261	PC3-261P	9.995	9.675	.490
264	PC3-264P	10.095	9.775	.490
267	PC3-267P	10.195	9.875	.490
270	PC3-270P	10.295	9.975	.490
273	PC3-273P	10.395	10.075	.490
276	PC3-276P	10.495	10.175	.490
279	PC3-279P	10.595	10.275	.490
282	PC3-282P	10.695	10.375	.490
285	PC3-285P	10.795	10.475	.490
288	PC3-288P	10.895	10.575	.490
291	PC3-291P	10.995	10.675	.490
294	PC3-294P	11.095	10.775	.490
297	PC3-297P	11.195	10.875	.490
300	PC3-300P	11.295	10.975	.490

\*See How to Order, pages 3, 4 and 5

# Low Mating Force PC connector 4 row contact arrangements

Number of Contacts	PC Number*	A Max.	B	C Max.
040	PC4-040P	2.295	1.975	.590
044	PC4-044P	2.395	2.075	.590
048	PC4-048P	2.495	2.175	.590
052	PC4-052P	2.595	2.275	.590
056	PC4-056P	2.695	2.375	.590
060	PC4-060P	2.795	2.475	.590
064	PC4-064P	2.895	2.575	.590
068	PC4-068P	2.995	2.675	.590
072	PC4-072P	3.095	2.775	.590
076	PC4-076P	3.195	2.875	.590
080	PC4-080P	3.295	2.975	.590
084	PC4-084P	3.395	3.075	.590
088	PC4-088P	3.495	3.175	.590
092	PC4-092P	3.595	3.275	.590
096	PC4-096P	3.695	3.375	.590
100	PC4-100P	3.795	3.475	.590
104	PC4-104P	3.895	3.575	.590
108	PC4-108P	3.995	3.675	.590
112	PC4-112P	4.095	3.775	.590
116	PC4-116P	4.195	3.875	.590
120	PC4-120P	4.295	3.975	.590
124	PC4-124P	4.395	4.075	.590
128	PC4-128P	4.495	4.175	.590
132	PC4-132P	4.595	4.275	.590
136	PC4-136P	4.695	4.375	.590
140	PC4-140P	4.795	4.475	.590
144	PC4-144P	4.895	4.575	.590
148	PC4-148P	4.995	4.675	.590
152	PC4-152P	5.095	4.775	.590
156	PC4-156P	5.195	4.875	.590
160	PC4-160P	5.295	4.975	.590
164	PC4-164P	5.395	5.075	.590
168	PC4-168P	5.495	5.175	.590
172	PC4-172P	5.595	5.275	.590
176	PC4-176P	5.695	5.375	.590
180	PC4-180P	5.795	5.475	.590
184	PC4-184P	5.895	5.575	.590
188	PC4-188P	5.995	5.675	.590
192	PC4-192P	6.095	5.775	.590
196	PC4-196P	6.195	5.875	.590
200	PC4-200P	6.295	5.975	.590
204	PC4-204P	6.395	6.075	.590
208	PC4-208P	6.495	6.175	.590
212	PC4-212P	6.595	6.275	.590
216	PC4-216P	6.695	6.375	.590
220	PC4-220P	6.795	6.475	.590

Number of Contacts	PC Number*	A Max.	B	C Max.
224	PC4-224P	6.895	6.575	.590
228	PC4-228P	6.995	6.675	.590
232	PC4-232P	7.095	6.775	.590
236	PC4-236P	7.195	6.875	.590
240	PC4-240P	7.295	6.975	.590
244	PC4-244P	7.395	7.075	.590
248	PC4-248P	7.495	7.175	.590
252	PC4-252P	7.595	7.275	.590
256	PC4-256P	7.695	7.375	.590
260	PC4-260P	7.795	7.475	.590
264	PC4-264P	7.895	7.575	.590
268	PC4-268P	7.995	7.675	.590
272	PC4-272P	8.095	7.775	.590
276	PC4-276P	8.195	7.875	.590
280	PC4-280P	8.295	7.975	.590
284	PC4-284P	8.395	8.075	.590
288	PC4-288P	8.495	8.175	.590
292	PC4-292P	8.595	8.275	.590
296	PC4-296P	8.695	8.375	.590
300	PC4-300P	8.795	8.475	.590
304	PC4-304P	8.895	8.575	.590
308	PC4-308P	8.995	8.675	.590
312	PC4-312P	9.095	8.775	.590
316	PC4-316P	9.195	8.875	.590
320	PC4-320P	9.295	8.975	.590
324	PC4-324P	9.395	9.075	.590
328	PC4-328P	9.495	9.175	.590
332	PC4-332P	9.595	9.275	.590
336	PC4-336P	9.695	9.375	.590
340	PC4-340P	9.795	9.475	.590
344	PC4-344P	9.895	9.575	.590
348	PC4-348P	9.995	9.675	.590
352	PC4-352P	10.095	9.775	.590
356	PC4-356P	10.195	9.875	.590
360	PC4-360P	10.295	9.975	.590
364	PC4-364P	10.395	10.075	.590
368	PC4-368P	10.495	10.175	.590
372	PC4-372P	10.595	10.275	.590
376	PC4-376P	10.695	10.375	.590
380	PC4-380P	10.795	10.475	.590
384	PC4-384P	10.895	10.575	.590
388	PC4-388P	10.995	10.675	.590
392	PC4-392P	11.095	10.775	.590
396	PC4-396P	11.195	10.875	.590
400	PC4-400P	11.295	10.975	.590

\*See How to Order, pages 3, 4 and 5

# Low Mating Force Connector Accessories

## polarization keys

General information follows on this page and the next three pages for assembling connector accessories with Amphenol® Low Mating Force B<sup>3</sup> Brush Contact Connectors.\* Provided are suggestions for proper connector installation that will help to maintain connector straightness after equipment assembly.

Low mating force connector bodies are intentionally designed to be non-rigid to facilitate application variables such as compliance to printed circuit boards, fixtures and card cages, vibration and shock exposure, thermal excursions and differential expansion characteristics. Users may employ installation procedures that will provide mating surface straightness of these non-rigid bodies within 0.010 inch to ensure maximum connector performance.

Generally, no external board support structures are required with B<sup>3</sup> brush contact connectors as long as the mounting surface offers sufficient rigidity. However, longer installations should consider external support to prevent excessive flexing of the connector/printed circuit board assembly.

### POLARIZATION KEYS

Polarization Keys, 10-285422-2 are accessory items, ordered separately for MB, DB, IO and PC Series Low Mating Force Connectors. If used, 4 keys are required per connector half. See page 5 for ordering information.

Examples at right show key locations for mating connector halves. The number or letter designations on all mating connectors are arranged so that the projecting keys on one relate to the same numbers or letters on the other. With the numbers or letters matching, the connector will mate.

#### TYPICAL CODE SEQUENCE

B, H-1, 5  
4 Different possibilities  
at each position = 256



DAUGHTER BOARD CONNECTOR WITH POLARIZATION KEYS

\* Installation Instructions for B<sup>3</sup> Low Mating Force Connectors had formerly been covered in publication L-1220. This has been discontinued and all installation instructions are covered here on pages 24-29.

### CONNECTOR ACCESSORIES THAT ARE USED WITH B<sup>3</sup> BRUSH CONNECTORS INCLUDE:

- Locking screws for I/O connector mounting to board
- Locking/mounting bushings:
  - for PC connector mounting to board or mating to I/O connector
  - for MB connector mounting to board or mating to I/O connector
- Polarization keys for each style connector provide up to 256 different key locations for alternate keying
- Test Probe kits for ensuring that contacts are properly wired within a connector and to prevent damage to brush contacts during probing.

For How to Order Accessories see page 5.

B<sup>3</sup> brush PC style connectors are shipped with PC tail combs that not only protect the tails during shipment, but aid the person assembling the connectors to boards to align the contacts.

Refer to page 2 of this catalog for illustration of the connector styles and how they mate.

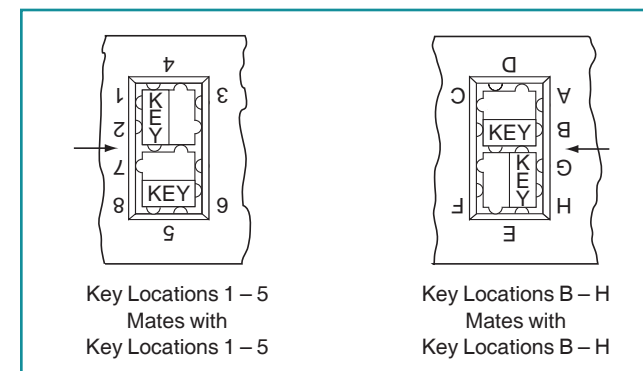

KEY LOCATIONS  
MOTHER BOARD OR PC CONNECTORS

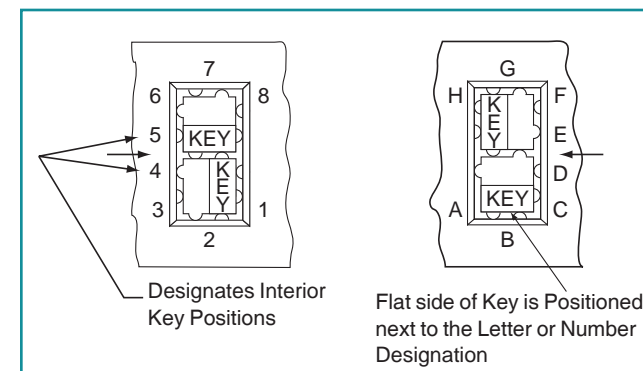

KEY LOCATIONS  
DAUGHTER BOARD OR INPUT/OUTPUT CONNECTORS

# Low Mating Force Connector Accessories

## test probe kit

In order to insure that contacts are properly wired within a connector, a Test Probe Kit is needed (Part number to order is 11-10400-22). This kit is especially designed to prevent damage to brush contacts during probing. It consists of a plastic holder, insert, and two contacts, usable for either Mother Board or Daughter Board applications. It is recommended that the user buy two kits, if using connectors of two genders. The kits are not convertible after assembly.

### Instructions:

**DB-IO Test Probe -** Slide the insert back over the wire and crimp contact on. Follow crimping procedure below. Then snap the insert and contact assembly into the holder.

**MB-PC Test probe -** Slide holder over wire and then crimp contact. Follow crimping procedure below. Slide the insert on the contact and seat it against the shoulder. Slide the holder forward and snap it onto the insert.

**Crimping Procedure:** Using accepted industry procedures, strip wire end to be terminated 1/8 to 5/32 inch. Care should be taken not to nick wire strands. Assemble the M22520/2-01 crimp tool and the M22520/2-27 positioner, and place tool selector in correct setting for wire size. Selected wire size must not have an insulation diameter more than .062 for MB-PC and not more than .038 for DB/IO.

AWG	22	24	26	28
SEL	5	4	3	2

Insert stripped wire end into contact wire well. Strands should be visible in wire well inspection hole. Bottom contact and wire assembly in positioner, and close handles of crimp tool to complete crimp. Handles will not open unless full crimping cycle has been completed.

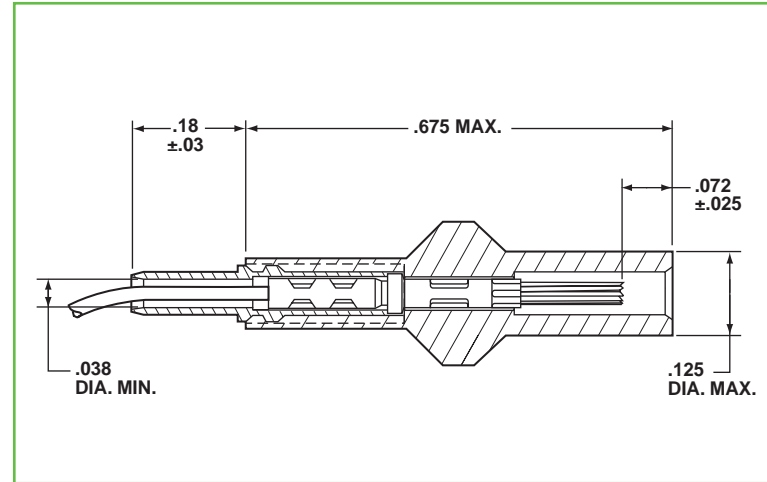

DAUGHTER BOARD - INPUT/OUTPUT TEST PROBE

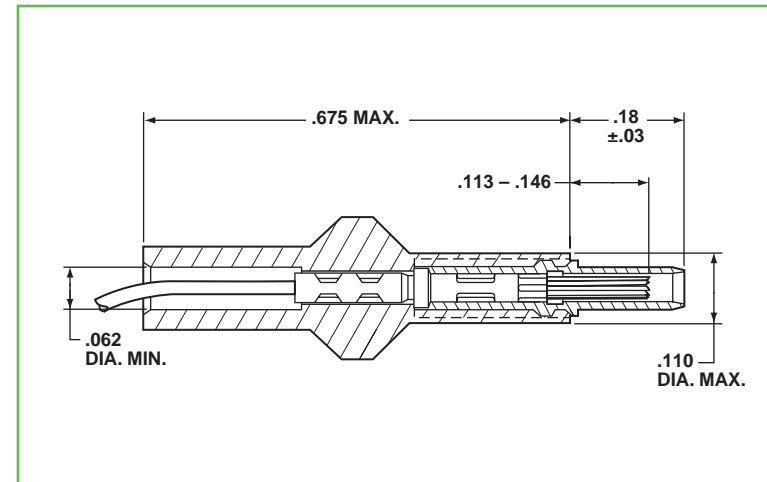

MOTHER BOARD - PC TEST PROBE

# Low Mating Force Connector Installation

## BRUSH CONNECTORS USER APPLICATION INFORMATION

The Brush B<sup>3</sup> connector is a highly sophisticated, innovative low mating force device designed to provide a multiplicity or highly redundant number of contact sites for high density, high performance applications. Contact resistance is stable and low, approximately 1/3 lower than the most widely available contemporary two piece printed circuit card connector type. To maximize the B<sup>3</sup> connector capability and assure the greatest potential reliability, several guidelines should be followed.

Ideally, connectors should be fully mated and not used as a packaging system tolerance absorber. Full mating occurs when the two molded thermoplastic contact housings (connector bodies) touch, plug skirt to receptacle shoulder over the entire length of the connector. However, manufacturing tolerances and user installation procedures must be considered and can be expected to prevent the "ideal" situation.

Connector bodies were intentionally designed to be non-rigid as permanent flexibility is necessary to allow compliance to user printed circuit cards, fixtures and card cages. Vibration and shock exposure, thermal excursions, contact repairability, and differential expansion characteristics further dictate the desirability of flexible connectors.

Amphenol drawing call-outs of part flatness to a 0.010 inch FIM (Total Indicator Reading - Full Indicator Movement) over the mating surface length is to be interpreted as in an "as used" condition. Rigid mounting of Mother Board (plug) parts to frames, multi-layer printed circuit boards or back panels should consider the need for the 0.010 inch maximum condition after soldering or solderless wrapping procedures.

Normal Mother Board parts in an unrestrained, unused condition may exceed the "as used" 0.010 inch reading at normal ambient or storage environments. Thermal cycling may further aggravate or adjust the condition. These parts present a profile from flat to a "smile" appearance when viewed from the side with the mating surface uppermost. (For example, see photo above). Normal positioning of this part on the Mother Board with slight restraint through use of mounting hardware or standard mounting bolts will automatically allow part compliance to the flatness condition of the board. Slight restraint is urged to allow for differential thermal expansion compensation during preheating and soldering operations. Final torquing or permanent fastening should be effected after cool down and thermal neutralization. Normal solderless wrapping procedures could ignore the differential expansion consideration.

Daughter Board connectors present the same flat to "smile" profile in a free state with the mating surface downward. The relief shelf can be used as a reference or guide when used with a straight edged Daughter Board or printed circuit board "page". Once proper positioning is verified and contact tails are solder fixed to the plated through holes, straightness will be permanently retained.

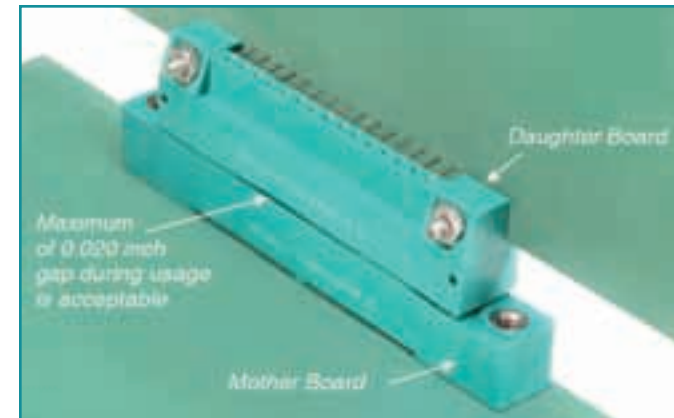

DAUGHTER BOARD AND MOTHER BOARD FULLY MATED CONDITION

Users are urged to monitor the quality of connector installation to optimize the mating of connectors.

During usage and when mated the worst case condition of the "as used" 0.010 inch maximum reading of both the plug and receptacle moldings of 0.020 inch. This condition is well within the B<sup>3</sup> product mated performance goals as our minimum effective electrical contact engagement has greater than a 100% safety factor. Users are urged to monitor the quality of connector installation to optimize the mating of connectors.

Input/Output connectors also normally exhibit a flat to "smile" profile with the mating surface downward. This "smile" condition self corrects once mated with the Mother Board counterpart and accessory locking screws are fastened. Again, checking for the 0.020 inch maximum gap is urged as a quality control monitor of user application techniques.

Amphenol has attempted to design in the ultimate for connector compliancy and self-correction during normal user installation procedures. The connector capabilities and inherent reliability rely in part on practical user procedures and application considerations. Refer to pages 27 - 29 for other installation instructions. And, refer to page 2 for correct mating of low mating force connectors. Amphenol board level engineers and product specialists are available to assist the user with application recommendations and processing guidance. Give us a call at 607-563-5011 and ask for board level technical assistance if further information is needed.

# Low Mating Force Connector Installation

## MOTHER BOARD CONNECTOR

MB connectors that are mounted on printed circuit boards should be installed on the board and held somewhat loosely, yet assuring all connector molding standoff pads contact the surface of the board, prior to soldering. There are several methods for attaching the MB connector to the board.

Inserting locking/mounting bushings with an arbor press is shown in the top photo at right. Locking/mounting bushing accessory, two per connector, may be inserted into 0.185 inch diameter CSK holes at each end of the front of a MB connector body. (Part number to order locking/mounting bushing is 10-41196-3). Using a light arbor press or similar device, firmly press the knurled section of the bushing into the lower 0.122 inch diameter hole until the front of the bushing is flush with, or slightly below, the front surface of the MB connector. Refer to Figure 1 at right.

Make sure the bushing and hole axis are properly aligned. Avoid excessive force which may crack the back surface of the MB connector body.

The back of the locking/mounting bushing has a 4-40 UNC-2A THD to mount the connector. Fasten the connector with a suitable washer and nut. The front of the locking/mounting bushing has a 4-40 UNC-2B THD which will mate with the locking screw accessory of an IO connector.

### Alternate Mounting Variations for Mother Board Connector

A clinch nut (such as all ESN A 79NCFMA2-26 or equivalent) may be pressed from the front, knurled end first, through the 0.185 diameter CSK into the 0.122 inch diameter hole at each end of the connector. An appropriate length 2-56 UNC-3A screw, washer, and nut may be used to mount the connector. Mounting forces should be applied to the bushing toward the rear of the connector. (See Figure 2 below)

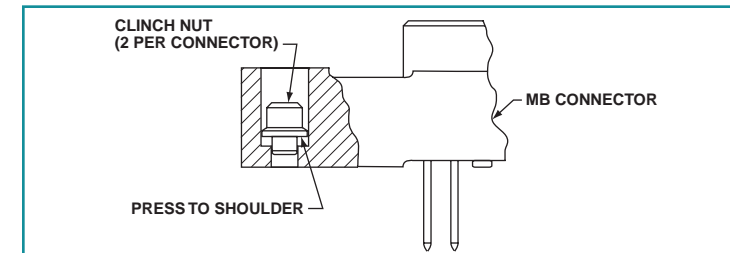

FIGURE 2: MB CONNECTOR WITH CLINCH NUT MOUNTING

When a Daughter Board is mated, use a 4-40 screw of appropriate length with a suitable washer under the head. Insert the screw from the front of the connector through the 0.185 inch diameter CSK into the 0.122 inch diameter hole at each end of the connector and fasten with a suitable washer and nut. (Refer to Figure 3 below). Torque to 5.5 pound-inch maximum after soldering operation has been completed.

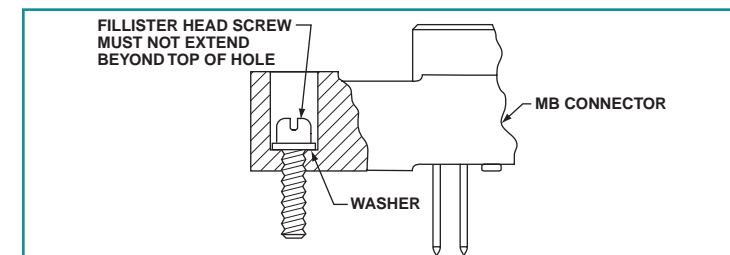

FIGURE 3: MB CONNECTOR WITH SCREW MOUNTING



LOCKING/MOUNTING BUSHING ACCESSORY INSERTED INTO MB CONNECTOR BODY

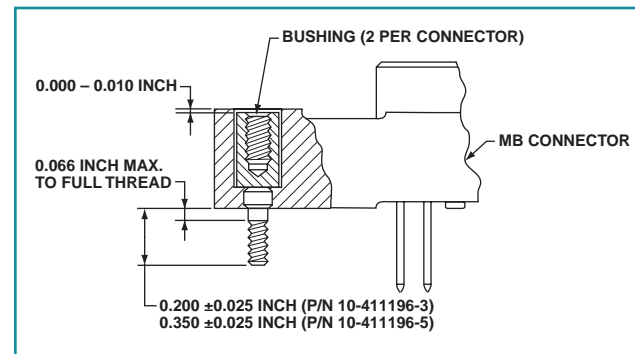

FIGURE 1: ASSEMBLY OF LOCKING/MOUNTING BUSHING INTO MB CONNECTOR

If MB connectors are to be wave soldered to printed circuit boards, the boards should be fixtured to maintain assembly straightness prior to and during the wave soldering process. (Refer to Figure 4 below).

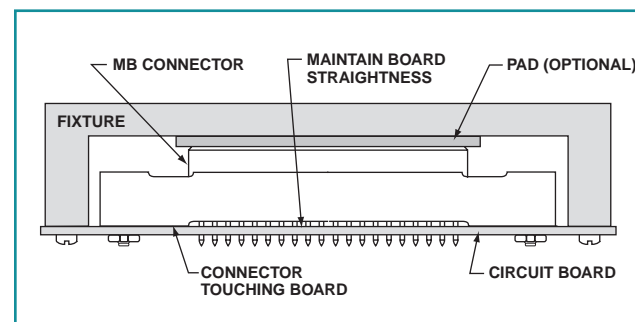

FIGURE 4: TYPICAL FIXTURE FOR SOLDERING MB CONNECTORS

# Low Mating Force Connector Installation

## DAUGHTER BOARD CONNECTOR

DB connectors should be loosely held on the printed circuit board prior to and during wave soldering. Care must be taken to ensure that the board does not bow away from the center of the connector during the soldering process. Also, especially on long length daughter board connectors, care must be taken that the connector does not bow on the circuit board. (Refer to Figure 5.)

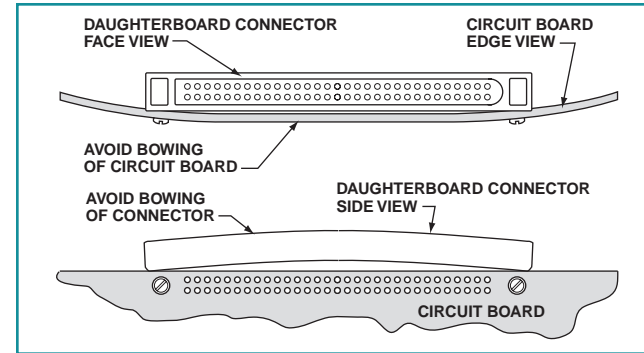

FIGURE 5: AVOID BOWING OF CIRCUIT BOARD AND/OR CONNECTOR WHEN ASSEMBLING DB CONNECTOR

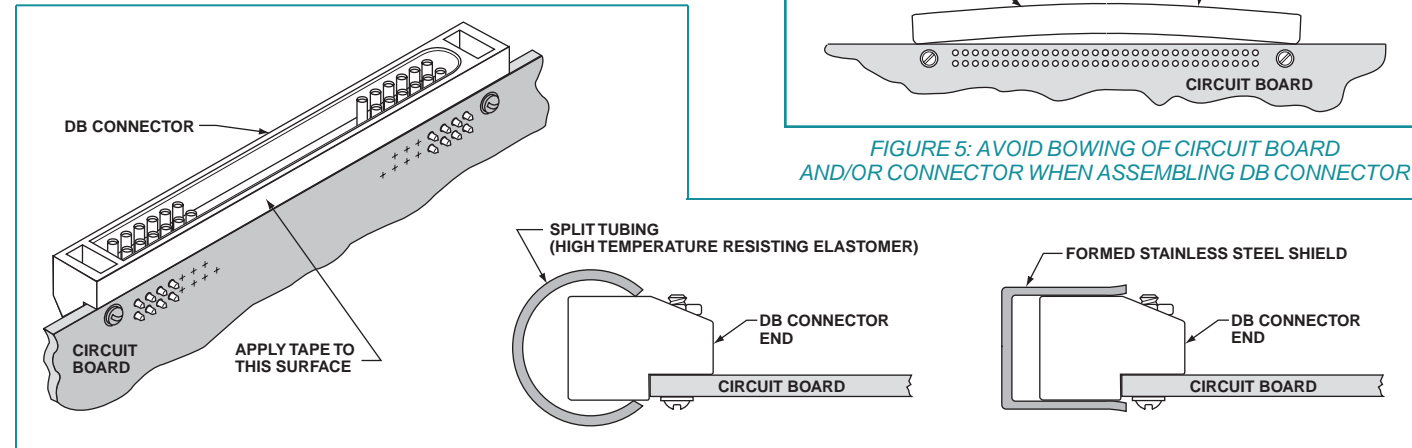

FIGURE 6: THREE TYPICAL MASKING APPLICATIONS FOR SOLDERING DB CONNECTORS

After soldering, mounting screws should be properly torqued.

For cosmetic purposes, the board side of the DB connector can be masked prior to wave soldering to protect it from heat exposure and solder wash. Acceptable masking may be accomplished with split tubing, stainless steel, or Mystik Tape #7010 or #7367. (Refer to Figure 6).

Printed wiring boards with DB connectors attached should be inserted into the housing until firmly seated. If possible, visual observation of the MB/DB mated condition is recommended. The fully mated condition occurs when the DB connector skirt bottoms on the MB or PC connector shoulder along the full length. (Refer to Figure 7).

Printed circuit boards should be supported in card guides and locked in position when connectors are fully mated.

## PC CONNECTOR

The PC connector should be loosely attached to the printed circuit board prior to any soldering of contacts.

Locking bushing accessory, two per connector, may be inserted from the back of a PC connector body into large mounting holes at each end. See photo at right. Part number to order locking bushing accessory for PC connectors is 10-411196-4. The 0.126 inch diameter cross holes in the locking bushing must be aligned with the 0.126 inch diameter cross hole in the PC connector body. These holes accept a 4-40 UNC-2A screw which should be long enough to allow mounting to the board. Fasten with a suitable washer and nut, making sure an appropriate washer is also under the head. The front of the locking bushing has a 4-40 UNC-2B thread which will mate with the locking bushing accessory of an IO connector.

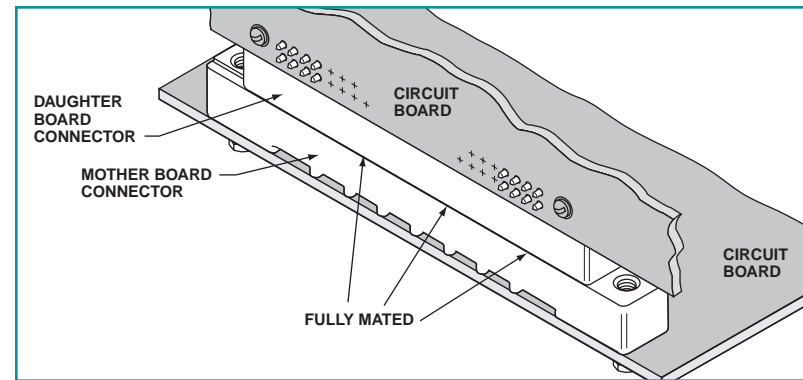

FIGURE 7: MB CONNECTOR & DB CONNECTOR IN FULLY MATED CONDITION



LOCKING BUSHING ACCESSORY INSERTED INTO PC CONNECTOR BODY



# Low Mating Force Connector Installation

## PC CONNECTOR, CONT.

The mounting surface to which the connector is applied should not extend forward of the shoulder of the PC connector. If the mounting surface does extend beyond the shoulder, a shim (minimum 0.005 inch thick) must be inserted between the connector body and the mounting surface. (Refer to Figure 8). After soldering, mounting screws should be properly torqued. Fixturing of the PC connector and mounting surface may be desirable to assure straightness after wave soldering.

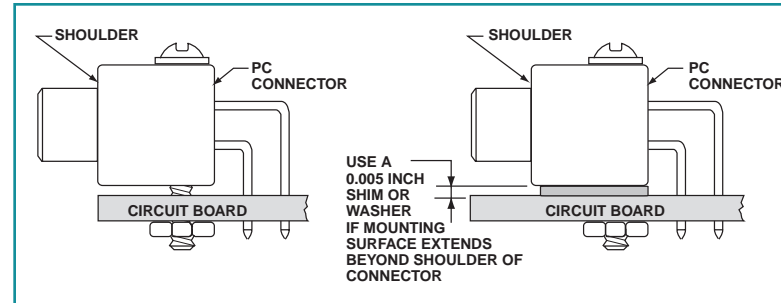
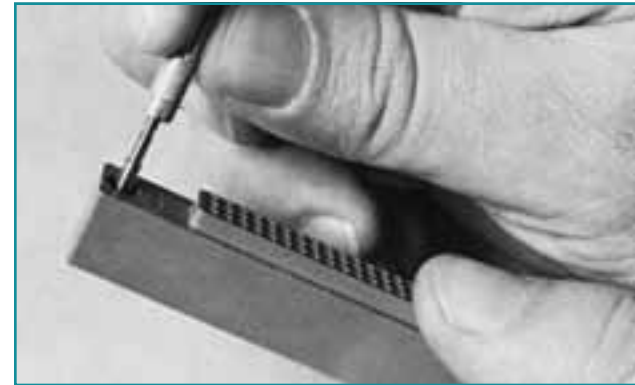

FIGURE 8: PC CONNECTOR MOUNTING

## INPUT/OUTPUT CONNECTOR

Use of mating hardware, such as locking screws, is recommended with I/O connectors. See photo at right. Locking screw accessory, two per connector, may be inserted into the large holes at each end of the back of an IO connector body. Part number to order locking screw accessory is 10-411196-4. By hand, press the locking screw firmly down into the cavity until it reaches a positive stop. The locking screw is then captivated in the retention system of the cavity. The front of the locking screw has a 4-40 UNC-2A thread which will mate with the locking bushing accessories of MB or PC connectors. (Refer to Figure 9 for I/O locking screw dimensions).

Should it be necessary to remove the captivated locking screw accessory, push the screw as far forward as possible. Using vise grip pliers to grasp the threaded end and pliers to hold the knurled end, apply torque until the locking screw breaks in two. Each half will then drop out.



LOCKING SCREW ACCESSORY INSERTED INTO I/O CONNECTOR BODY

## Alternate Mounting Variation for Input/Output Connectors

For fixed mounting, a 6-32 thread forming screw, type AB (MS5186) may be inserted through the mounting member and into the holes at each end of the connector body from the back. The screws must be used with suitable washers and must be of sufficient length to penetrate the connector body 0.350 inch. Care must be taken not to over-tighten the screws.

Visual observation of the mating of the MB connector to the I/O connector or the PC connector to the I/O connector is recommended. The fully mated condition occurs when the I/O connector skirt bottoms on the MB or PC shoulder along the full length. (Refer to Figure 10).

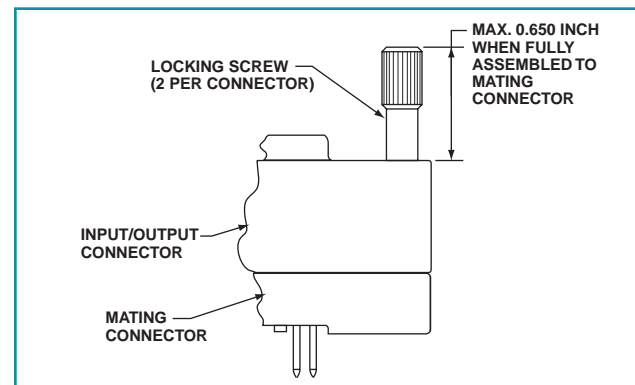

FIGURE 9: I/O LOCKING SCREW DIMENSIONS

Printed circuit boards containing PC connectors that are mating with I/O connectors should utilize a holding device that is capable of locking the board in place to prevent back-off during use.

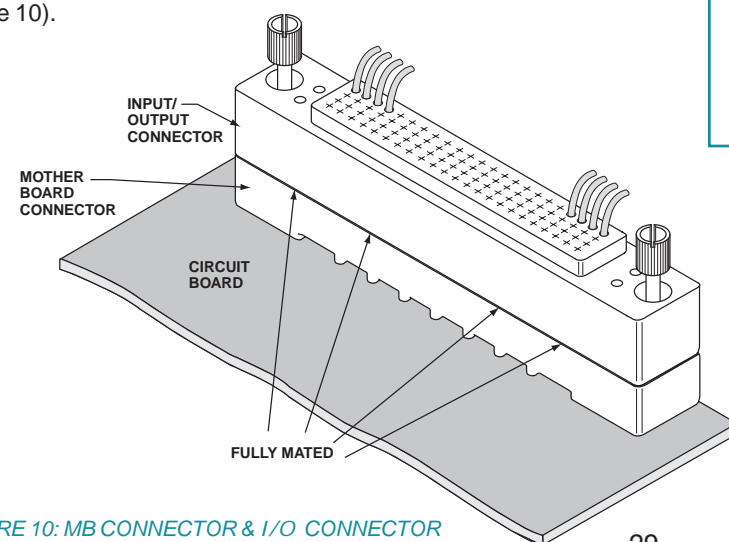

FIGURE 10: MB CONNECTOR & I/O CONNECTOR FULLY MATED CONDITION

# Low Mating Force Connector

## Smaller Sizes with .100 X .100 Sq. Inch Grid

### design flexibility

To meet more customer needs and provide more design flexibility, Amphenol expanded their low mating force connector family with smaller contact count connectors (sizes with less than standard 10 contacts per row). These are available with as few as 10 brush contacts per connector and up to 36 brush contacts per connector. The arrangements are in the same .100 X .100 square inch grid pattern as standard low mating force connectors. They are offered in mother board, daughter board, input/output and printed circuit styles. (Shown on this page and the following page). For how to order information please consult Amphenol Aerospace.



LOW MATING FORCE CONNECTORS IN SMALLER SIZES

#### Mother Board Connector

Number of Contacts	Contact Pattern	A Max.	B	C Max.
10	2 Row X 5	1.795	1.475	.390
12	2 Row X 6	1.895	1.575	.390
14	2 Row X 7	1.995	1.675	.390
15	3 Row X 5	1.795	1.475	.490
16	2 Row X 8	2.095	1.775	.390
18	2 Row X 9	2.195	1.875	.390
	3 Row X 6	1.895	1.575	.490
20	4 Row X 5	1.795	1.475	.590
21	3 Row X 7	1.995	1.675	.490
	3 Row X 8	2.095	1.775	.490
24	4 Row X 6	1.895	1.575	.590
27	3 Row X 9	2.195	1.875	.490
28	4 Row X 7	1.995	1.675	.590
32	4 Row X 8	2.095	1.775	.590
36	4 Row X 9	2.195	1.875	.590

E Tail Length ±.020
.148
.180
.335

#### Mother Board Connector

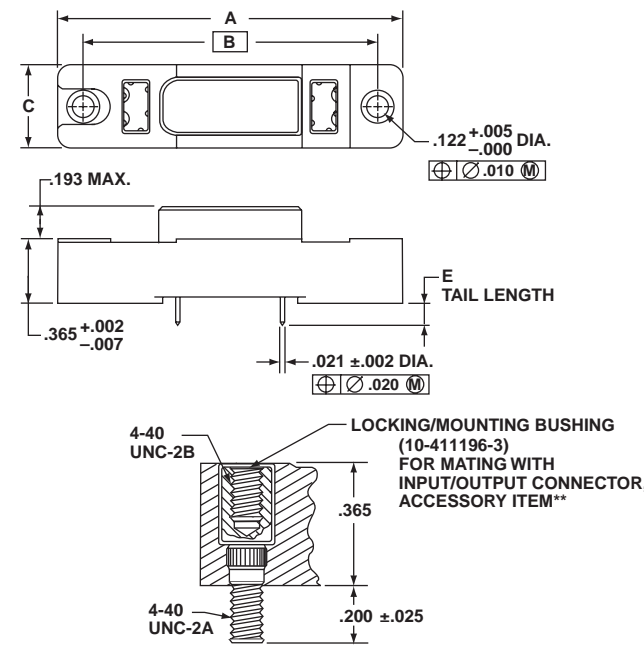

\*\* Accessory item supplied separately. See Accessory How to Order page 5 and page 27 for alternate mounting methods.

#### Daughter Board Connector

Number of Contacts	Contact Pattern	A Max.	B	C Max.	D Max.
10	2 Row X 5	1.180	.850	.375	.545
12	2 Row X 6	1.280	.950	.375	.545
14	2 Row X 7	1.380	1.050	.375	.545
15	3 Row X 5	1.180	.850	.475	.645
16	2 Row X 8	1.480	1.150	.375	.545
18	2 Row X 9	1.580	1.250	.375	.545
	3 Row X 6	1.280	.950	.475	.645
20	4 Row X 5	1.180	.850	.575	.745
21	3 Row X 7	1.380	1.050	.475	.645
24	3 Row X 8	1.480	1.150	.475	.645
	4 Row X 6	1.280	.950	.575	.745
27	3 Row X 9	1.580	1.250	.475	.645
28	4 Row X 7	1.380	1.050	.575	.745
32	4 Row X 8	1.480	1.150	.575	.745
36	4 Row X 9	1.580	1.250	.575	.745

E Tail Length ±.020
.085
.120
.300

#### Daughter Board Connector

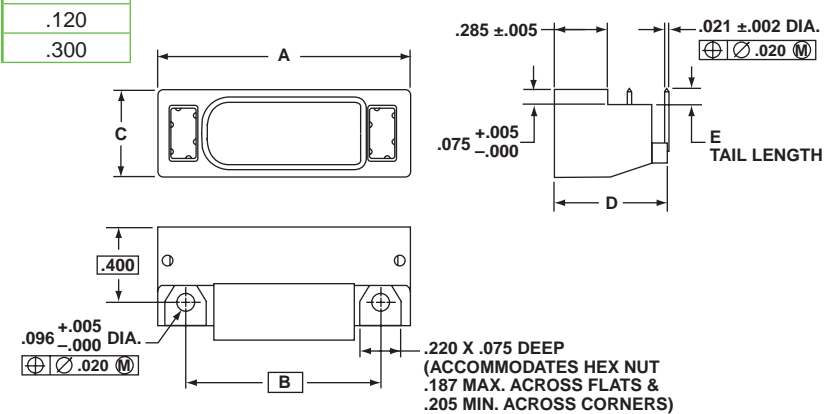

# Low Mating Force Connector

## Smaller Sizes, cont.

design flexibility

### Input/Output Connector

Number of Contacts	Contact Pattern	A Max.	B	C Max.
10	2 Row X 5	1.795	1.475	.390
12	2 Row X 6	1.895	1.575	.390
14	2 Row X 7	1.995	1.675	.390
15	3 Row X 5	1.795	1.475	.490
16	2 Row X 8	2.095	1.775	.390
18	2 Row X 9	2.195	1.875	.390
	3 Row X 6	1.895	1.575	.490
20	4 Row X 5	1.795	1.475	.590
21	3 Row X 7	1.995	1.675	.490
24	3 Row X 8	2.095	1.775	.490
	4 Row X 6	1.895	1.575	.590
27	3 Row X 9	2.195	1.875	.490
28	4 Row X 7	1.995	1.675	.590
32	4 Row X 8	2.095	1.775	.590
36	4 Row X 9	2.195	1.875	.590

Contact Type	K Dia. ±.020	E Tail Length ±.020
Rear Removable Crimp Contact	N/A	N/A
Round PCB Stud Solder Termination	.021	.145
	.021	.335

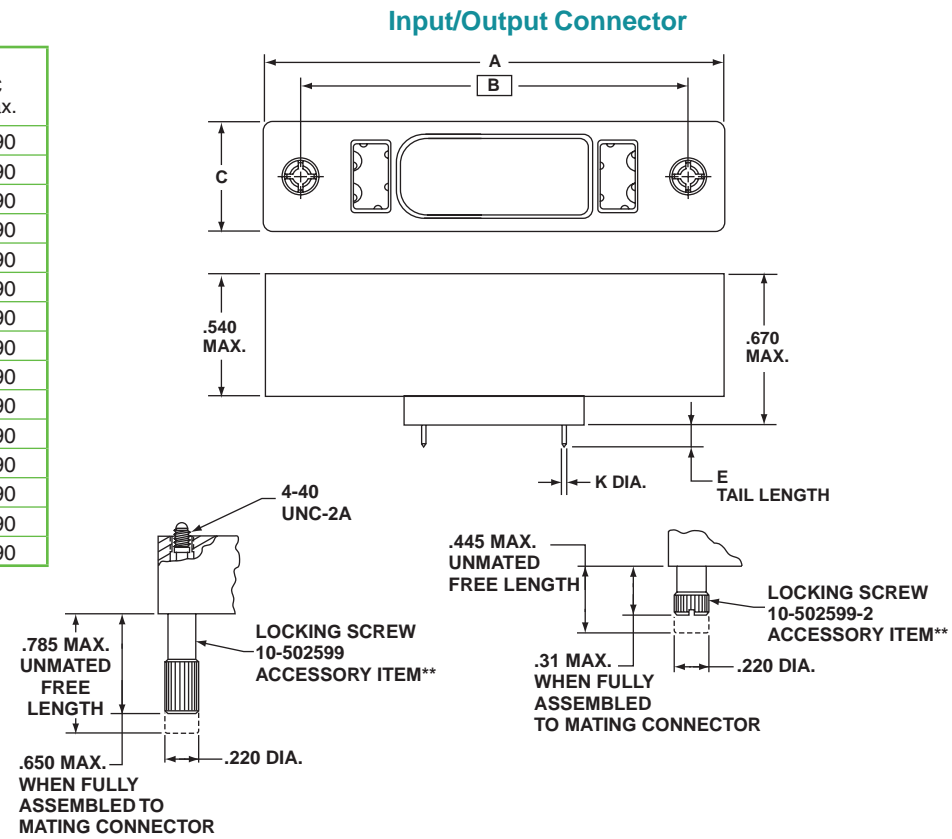

### Printed Circuit Connector

Number of Contacts	Contact Pattern	A Max.	B	C Max.	D Max.
10	2 Row X 5	1.180	.850	.375	.545
12	2 Row X 6	1.280	.950	.375	.545
14	2 Row X 7	1.380	1.050	.375	.545
15	3 Row X 5	1.180	.850	.475	.645
16	2 Row X 8	1.480	1.150	.375	.545
18	2 Row X 9	1.580	1.250	.375	.545
	3 Row X 6	1.280	.950	.475	.645
20	4 Row X 5	1.180	.850	.575	.745
21	3 Row X 7	1.380	1.050	.475	.645
24	3 Row X 8	1.480	1.150	.475	.645
	4 Row X 6	1.280	.950	.575	.745
27	3 Row X 9	1.580	1.250	.475	.645
28	4 Row X 7	1.380	1.050	.575	.745
32	4 Row X 8	1.480	1.150	.575	.745
36	4 Row X 9	1.580	1.250	.575	.745

E Tail Length ±.020
.095
.150

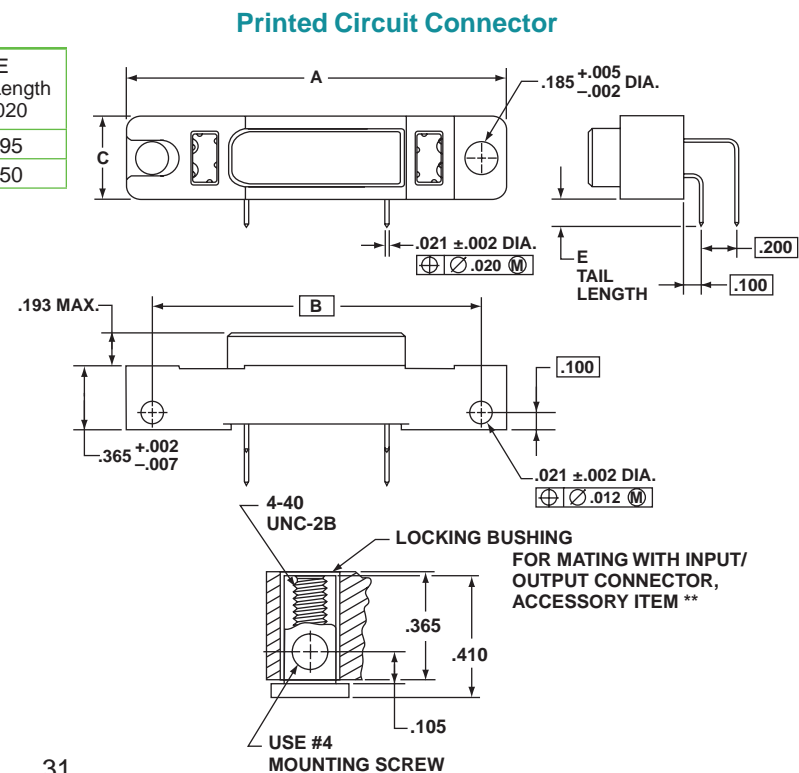

\*\* Accessory item supplied separately. See Accessory How to Order page 5 and page 27 for alternate mounting methods.

# Hybrid Configurations with Contact Options

## signal, power, coax or fiber optics

The B<sup>3</sup> Brush contact is the standard contact for Low mating force connectors due to its low mating force, stable electrical performance and extended service life. Design flexibility is expanded with the ability to add combinations of other types of contacts: signal, power, high speed coax or fiber optic termini; in one high density hybrid connector.

Power, shielded coax or twinax contacts, in combination with Brush signal contacts are available in configurations of the following (see next page for illustrations):

- A single row of size 16 power or coax or twinax contacts with 2 rows of brush contacts
- A single row of size 12 power or coax or twinax contacts with 3 rows of brush contacts
- A double row of size 16 power or coax or twinax contacts with 4 rows of brush contacts

Power and coax contacts are standard MIL-DTL-38999 Series II type. Consult Amphenol board level product marketing (800-678-0141) for assistance with available hybrid configurations.

NOTE: Power and coax contacts and fiber optic termini are not provided with the connector and must be purchased separately.

### POWER STRIP CONNECTORS

Amphenol's Power Strip connectors were developed for use as a dedicated power interface between module cards and backplanes. These connectors use the same insert bodies as Amphenol low mating force connectors, but have power contacts rather than brush contacts. Cavities allow for size 16 or 12 power contacts. Or, coax/twinax contacts can also be used in these size 16 or 12 cavities.

### HYBRID BRUSH CONNECTORS WITH FIBER OPTIC TERMINI

Amphenol's superiority and breadth of product offering is demonstrated in its capability for packaging fiber termini and the Brush contact in a printed circuit board rectangular connector. Fiber optic MIL-PRF-29504 termini size 16 and HD20 can be used as well as the 90° termini style with optical performance the same as when used in cylindrical connectors.

For more information on Amphenol fiber optic connectors and termini, see the Fiber Optic section of Amphenol's Combined Circular Interconnects catalog on-line at [www.amphenol-aerospace.com](http://www.amphenol-aerospace.com).



COMBINATION OF BRUSH CONTACTS & SHIELDED CONTACTS

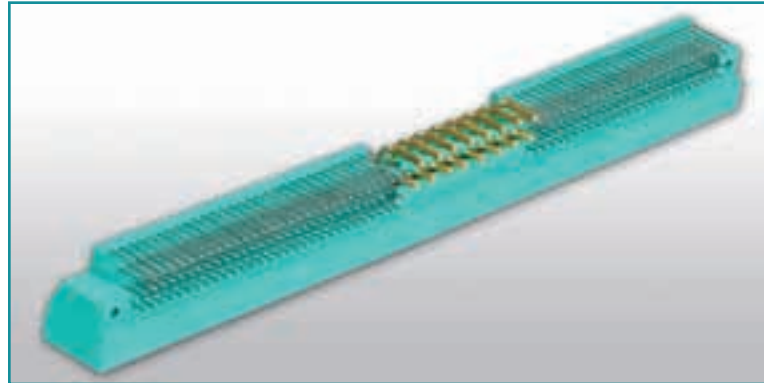

CONNECTOR WITH BRUSH CONTACTS & SIZE 16 POWER PIN CONTACTS



POWER STRIP RECTANGULARS WITH SIZE 16 POWER CONTACTS

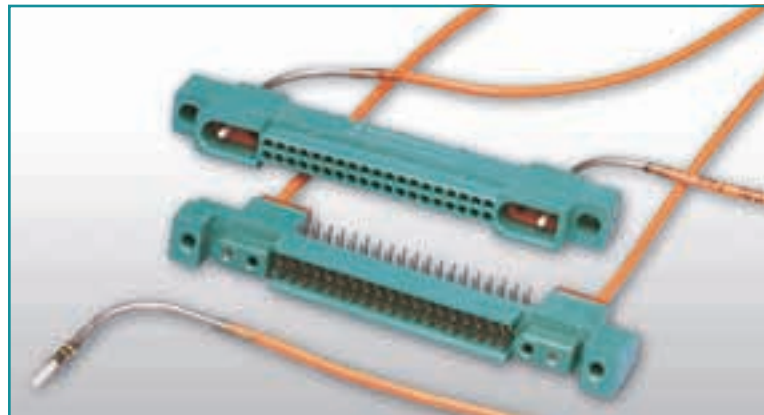

COMBINATION OF BRUSH CONTACTS & MS29504 FIBER OPTIC TERMINI

# Custom Hybrid Designs, Small Color-Coded Brush Connectors design flexibility

The following shows a few hybrid configuration connectors that have been developed. Consult Amphenol Aerospace for assistance in solving design problems and for part numbers that will provide the proper combination of these hybrid configurations to meet your specific connector application requirements.

**Hybrid: 30 B<sup>3</sup> brush contacts,  
6 size 12 power/coax/twinax contacts**

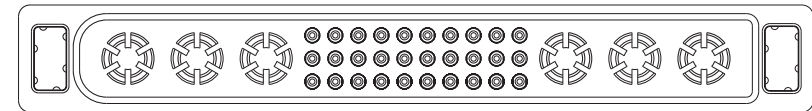

**Hybrid: 40 B<sup>3</sup> brush contacts, 16 size 16 power/coax/twinax contacts**

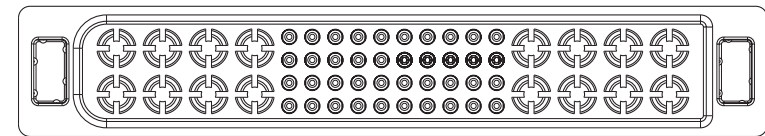

**Hybrid: 30 B<sup>3</sup> brush contacts, 10 size 12 power/coax/twinax contacts**

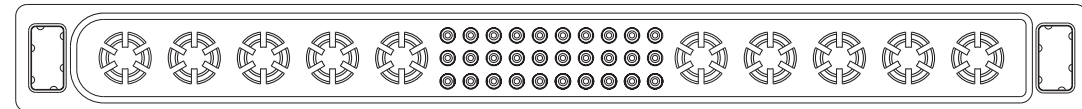

**Hybrid: 15 B<sup>3</sup> Brush contacts, 4 size 12 power/coax/twinax contacts**

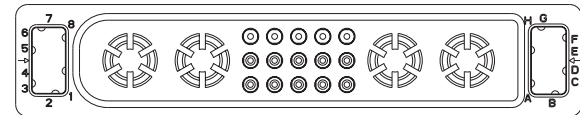

**Hybrid: 10 B<sup>3</sup> brush contacts, 4 size 16 power/coax/twinax contacts**

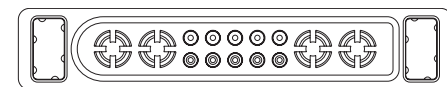

**Hybrid: 40 B<sup>3</sup> Brush contacts,  
4 size 16 power/coax/twinax contacts**

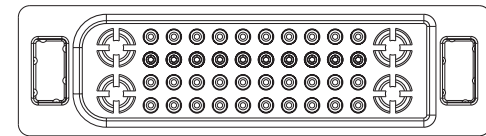

Amphenol can meet innovative connector solutions with custom designs. Our board level engineers can work with customers who need special contact arrangements or special sized inserts.

The special hybrid connector shown at right was developed for the Vetronics System on a military tank. This custom shape insert design houses a combination of contact types, a sealing grommet and it has special mounting/locking screws.

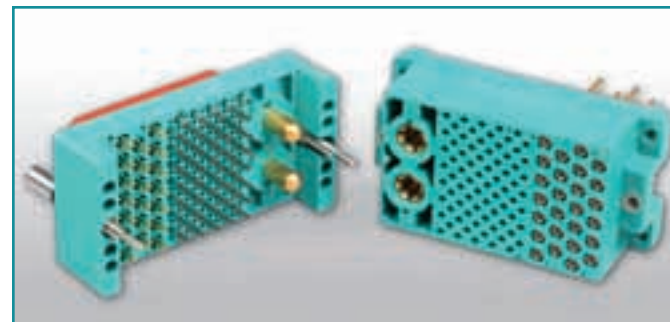

HYBRID CUSTOM CONNECTOR WITH  
75 BRUSH DIGITAL CONTACTS,  
26 SIZE 16 POWER CONTACTS & 2 SIZE 04 POWER CONTACTS

## SMALL COLOR-CODED BRUSH CONTACT CONNECTORS DESIGNED FOR MEDICAL INSTRUMENTATION

Amphenol has responded to the needs of the medical industry by offering even smaller inserts with brush contacts. These small profile, but highly reliable interconnects, are ideal for medical and test equipment such as patient monitoring systems. Color coding of these connectors was a market-driven requirement for frequent plugging and unplugging on equipment, so Amphenol provides these small sized brush connectors in a variety of color materials.



SMALL COLOR-CODED BRUSH CONNECTORS WITH AS  
FEW AS 5 CONTACTS PER CONNECTOR

# Other Brush Contact Rectangular Connectors

## Docking Connectors

with (.0787 inch X .100 inch) staggered grid spacing

### BRUSH CONTACT CONNECTORS MAKE THE IDEAL CHOICE FOR FREQUENT DOCKING APPLICATIONS

When frequent docking to charge and transfer data is a necessity, the brush contact system offers high performance of over 100,000 mating cycles. This long contact life without degradation in performance provides customers with reliability in frequent docking applications such as:

- Handheld GPS units
- Handheld radios
- Rugged computers
- Controllers
- Scanners
- Accessories
- Cellular phones

#### Performance

Durability: . . . . . Up to 100,000 mating cycles  
 Insertion/Extraction Force: . . . . . 1.5 ounce typical per contact  
 Operating Temperature: . . . . . -65° to 125°C  
 Current Rating: . . . . . Up to 5 amperes (termination dependent)  
 Hot swap 1 ampere maximum (load dependent)

Data Rate  
 (Select connectors only): . . . . . Configurable for 3.125 Gbps differential signal  
 Insulation Resistance: . . . . . 5 gigohms minimum  
 Dielectric Withstanding  
 Voltage: . . . . . 750 volts @ sea level minimum  
 250 volts @ 70,000 feet elevation min.  
 Solderability: . . . . . MIL-STD-202, method 208  
 Salt Fog: . . . . . 48 hours IAW MIL-STD-1344, method 1002, type II  
 Humidity: . . . . . IAW MIL-STD-1344, method 1002, type II  
 Vibration: . . . . . 4 hours in each of 3 mutually perpendicular axes IAW MIL-STD-1344, method 2004, test condition G  
 Shock: . . . . . 1 shock along each of three mutually perpendicular axes IAW MIL-STD-1344, method 2004, test condition G

#### Features

Radial Misalignment: . . . . . Capable of correcting up to a .040" initial radial misalignment  
 Angular Misalignment: . . . . . Capable of mating with up to a 4° initial angular misalignment  
 Polarization: . . . . . "D" shaped interface  
 Color: . . . . . Standard is black, variety of other colors are available

#### Materials

Insulator: . . . . . Glass-filled thermoplastic molding  
 Contact: Wire . . . . . Beryllium copper per ASTM B197; finish is gold per ASTM B488 over nickel per AMS-QQ-N-290  
 Holder . . . . . Brass similar to UNS C33500; finish is gold per MIL-G-45204 or tin-lead per MIL-P-81728 or tin per MIL-T-10727 (RoHS compliant)  
 Sleeve: . . . . . Stainless steel per AMS-5514, passivated IAW QQ-P-35 (DB and I/O connectors only)

For more information, including how to order, consult Amphenol Aerospace. Call 800-678-0141 and ask for Amphenol board level product marketing for assistance.



Amphenol offers Docking Connectors in a compact size, with tighter spaced custom brush contacts (.0787 inch x .100 inch staggered grid spacing).

#### Mother Board Docking Connector

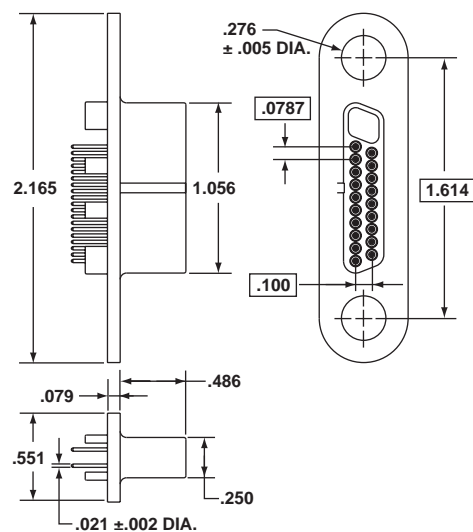

#### Daughter Board Docking Connector

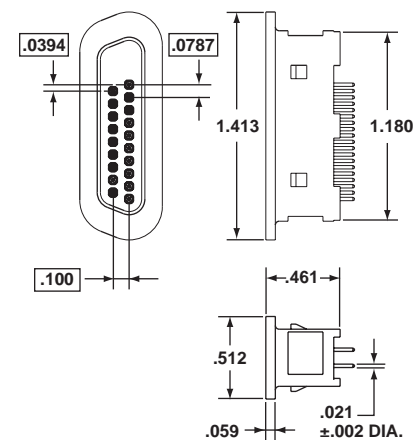

# Other Brush Contact Rectangular Connectors

## HDB<sup>3</sup> High Density Brush Series - tighter (.070 in. X .060 in.) staggered grid spacing

### HDB<sup>3</sup> CONNECTORS

The new connector series of brush connectors incorporates an even higher density contact pattern and lower mated height than Amphenol's standard low mating force rectangular connectors. These HDB<sup>3</sup> connectors utilize the same durable and reliable B<sup>3</sup> brush contact, but in a tighter .070 inch X .060 inch staggered grid spacing. They offer the advantage of a higher density pattern in a compact-height connector that will take up less board space; thus saving cost over adding additional connectors to meet power requirements. HDB<sup>3</sup> connector styles include mother board, daughter board, input/output and a stacker style. For how to order information of the HDB<sup>3</sup> see Amphenol brochure SL-402\* online at [www.amphenol-aerospace.com](http://www.amphenol-aerospace.com).



When more contact density is required, the HDB<sup>3</sup> High Density Series with .070 inch X .060 inch staggered grid spacing is the solution.

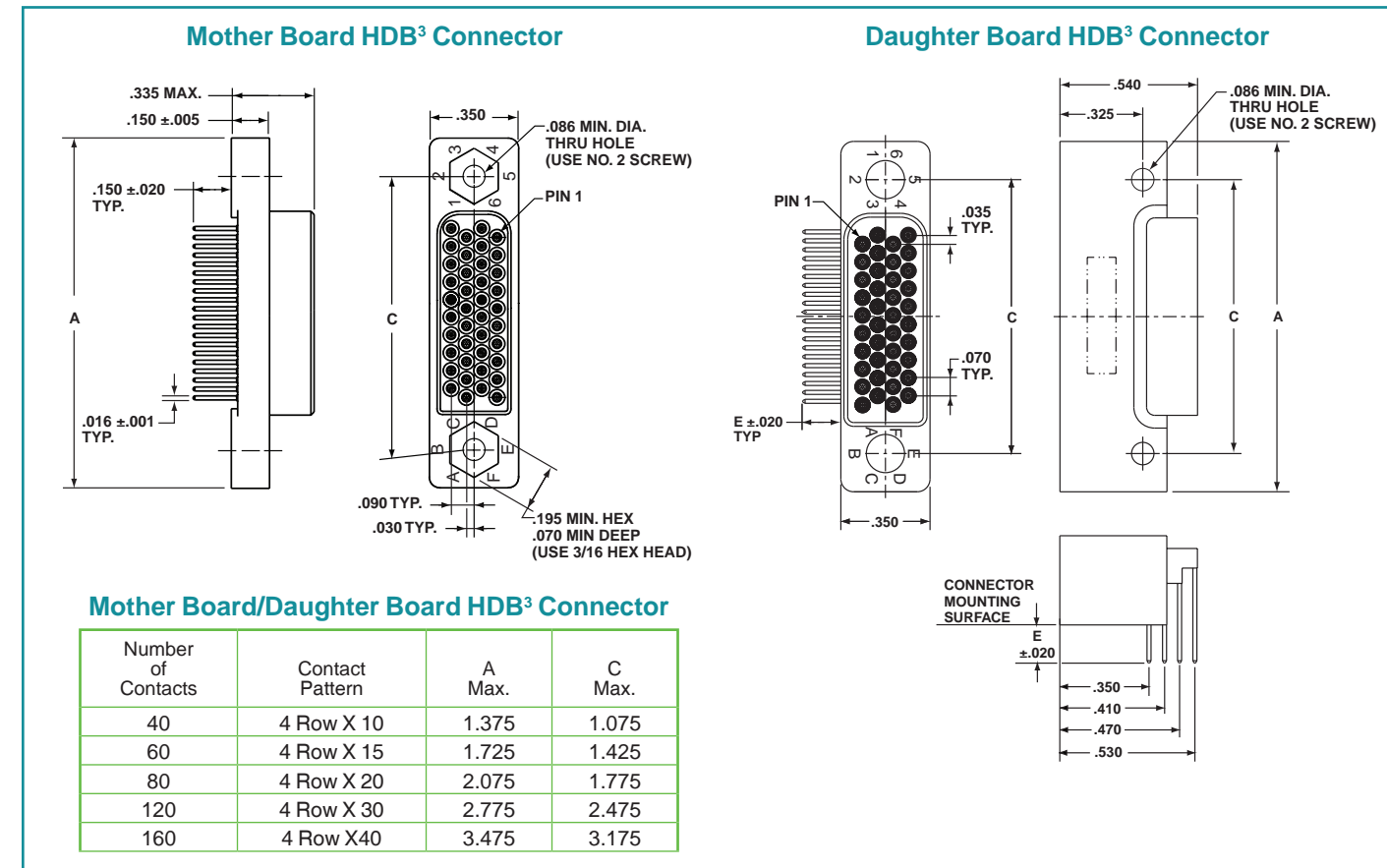

\* Also in SL-402 brochure are other HDB<sup>3</sup> style connectors: input/output style, stacker and high speed configurations.

Please note, the new Amphenol Combined Rectangular Products catalog, 12-R1, will combined 12-035 (this catalog) and HDB3 product covered in SL-402, along with other Amphenol rectangular interconnect products. Ask for the new combined Amphenol Rectangular Interconnect Products catalog; available Jan. 2011

# Other Brush Contact Rectangular Connectors

## HSB<sup>3</sup> High Density Series with 3.125 Gb/s High Speed data rate

### HSB<sup>3</sup> CONNECTORS

The HSB<sup>3</sup> is a further new development of the higher density HDB<sup>3</sup> connector series. The HSB<sup>3</sup> offers higher speed as well as higher density. Benefits include:

- Allows data rates up to 3.125 Gb/s via 100 ohm matched impedance differential pairs
- Uses partially populated HDB<sup>3</sup> mother board and daughter board inserts. See HSB<sup>3</sup> arrangements below.

For more information refer to Amphenol® brochure SL-402, on-line at [www.amphenol-aerospace.com](http://www.amphenol-aerospace.com). or call 800-678-0141 and ask for Amphenol board level product marketing for assistance.



HSB<sup>3</sup> HIGH DENSITY/HIGH SPEED BRUSH CONNECTOR

### HSB<sup>3</sup> Insert Arrangements

As viewed from front face of Daughter Board Connector

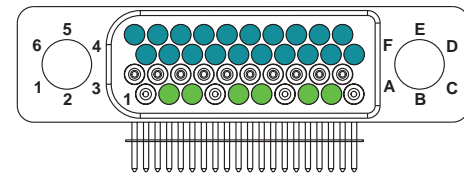

40 Pin Body with 3 Differential Pair, 20 Signal Contacts

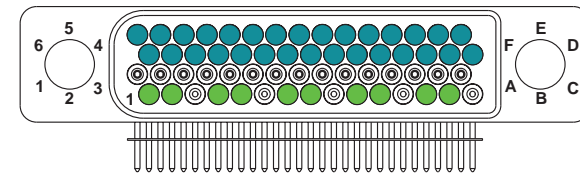

60 Pin Body with 5 Differential Pair, 30 Signal Contacts

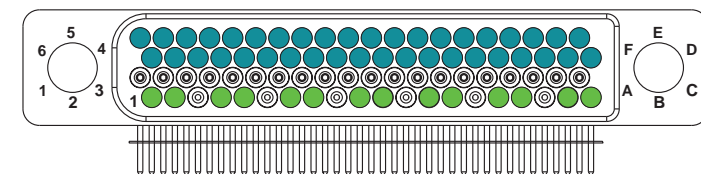

80 Pin Body with 7 Differential Pair, 40 Signal Contacts

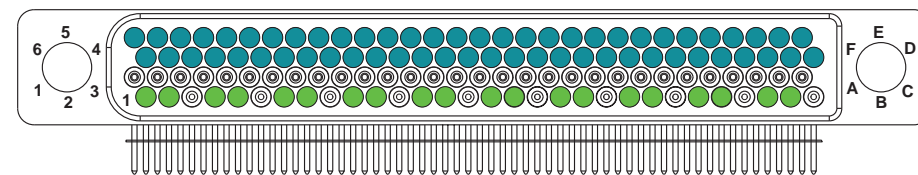

120 Pin Body with 10 Differential Pair, 60 Signal Contacts

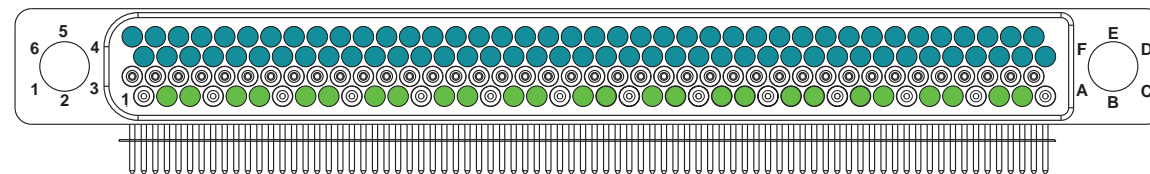

160 Pin Body with 13 Differential Pair, 80 Signal Contacts

#### KEY

-   100 Ohm Differential Pair Contacts  
(100 Ohm Differential contact pairs capable of 3.125 Gb/s data rates)
-  Empty Contact Cavity
-  Standard Digital, Low Speed Signal Contacts



# Other Brush Contact Rectangular Connectors

## Ruggedized, Non-Floating Brush Rack and Panel Connectors

This new connector series utilizes Amphenol's durable and reliable B<sup>3</sup> contact system in a rugged, non-floating Rack and Panel connector. Included in this series are digital and power/digital "hybrid" insert arrangements.

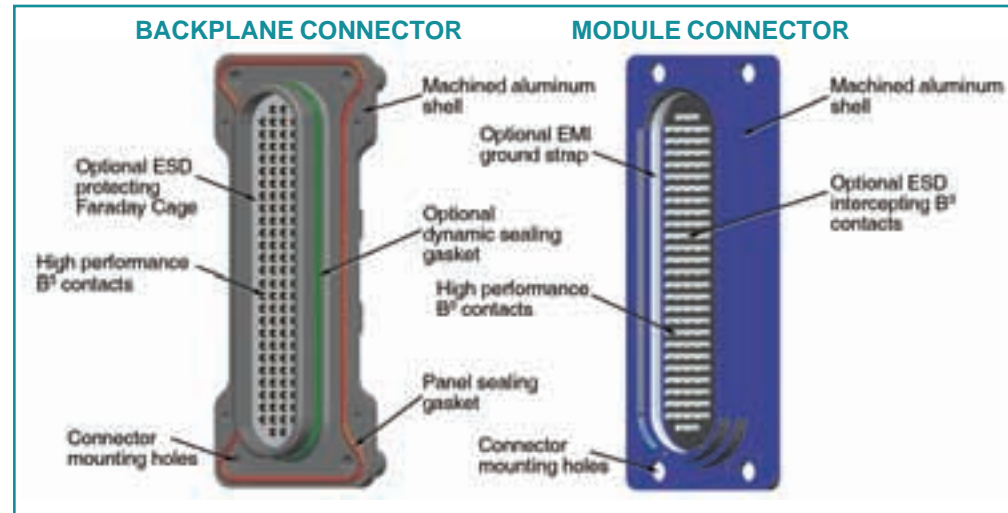

Standard Ruggedized, Non-floating Brush Rack and Panel Connector Features include:

- 126 high performance B<sup>3</sup> brush contacts
- 0.100 inch x 0.100 inch square grid footprint
- Environmentally sealed at connector interface with mated (optional feature)
- Environmentally sealed connector mounting interface
- EMI protection is available at mounting surfaces and connector interface
- ESD protection is available - allows use of Class 3 hardened chips (4KV max. voltage)

Standard Ruggedized Brush Rack and Panel Connector Performance:

- Durability: 500 mating cycles
- Insertion/Extraction Force: 7 lbs. typical
- Operating Temp.: -60° to +125°C
- Current Rating: 3 amperes  
Hot swap 1 ampere maximum (load dependant) - non ESD protected version
- Insulation Resistance: 1 goghm minimum
- Dielectric Withstanding Voltage: 500V, 60 Hz RMS @ sea level  
300V, 60 Hz RMS @ 15,000 ft. elevation
- Solderability: J-STD-004, -005 & -006
- Salt Fog: EIA-364-26B, test condition B
- Humidity: EIA-364-31B, test method III
- Vibration: EIA-364-28B, test condition III
- Shock: EIA-364-27B, test condition G

Hybrid arrangements are available as shown in top photo at right, that utilize a combination of brush contacts and high power RADSOK® contacts. The photo shows a 74 signal and 6 power configuration. For other hybrid arrangements and assistance on how to order this product, consult Amphenol Aerospace.



HYBRD RUGGEDIZED, NON-FLOATING RACK & PANEL CONNECTOR  
(8 RADSOK® HIGH POWER CONTACTS, 72 BRUSH CONTACTS)



2 BAY SHELL CONFIGURATION RUGGEDIZED, NON-FLOATING RACK AND PANEL CONNECTOR  
(126 BRUSH CONTACTS PER BAY)

# Other Brush Contact Rectangular Connectors

## LRM (Line Replaceable Modules)

### AMPHENOL CONTINUES TO DEVELOP INTERCONNECTS THAT MEET THE DEMANDS OF THE AVIONICS INDUSTRY

Starting with the development of the B<sup>3</sup> contact, incorporated into the low mating force PCB connectors, the LRM line replaceable module followed as the avionics high density rectangular interconnect solution. LRM interconnects are combinations of module and backplane inserts, in one bay, two bay, three bay or more configurations. LRM products are used on major programs of aircraft and military vehicles.

This page and the next briefly describe the LRM family of connectors. For complete information please see Amphenol® High Performance Line Replaceable Module (LRM) Interconnects catalog, 12-037.\*

The Brush contact has superior performance in LRM interconnects due to its low mating force, stable electrical performance and extended life. Other LRM features include:

- Backplane versatility: available with through-hole solder posts or with compliant pins for solderless applications
- Wide range of PCB/heat sink accommodations with standard surface mount tails or flex termination
- Polarization keys - up to 4096 possible keying positions
- Superior intermittency-free performance under vibration
- Dielectric withstanding voltage: Staggered grid and GEN-X styles: 100 volts at sea level (due to the incorporation of ESD shield)
- Temperature range: suitable for vapor phase soldering; normal operating temp. is -65°C to +125°C
- Current rating: 3.0A derated to 1.5A typical (dependant on loading)

### LRM CONNECTORS WITH STAGGERED GRID

- Provides higher contact density for high speed integrated circuitry in SEM-E and custom form factors
- 180 contact insert pattern grid in 8 rows: 0.100 inch spacing along the row with 0.050 inch between rows, rows offset 0.050 inch
- Options include various shell designs to accommodate a wide range of PC board/heat sink combinations
- Solder tail, wire wrap or compliant contact availability
- Amphenol ESD (Electrostatic Discharge) protection: Utilization of the Faraday Cage principal to shunt electrostatic discharge events to the conductive enclosure on which the connector is mounted, thus never allowing the high voltage, high current discharge event to reside on any contacts.
- Designed for level 2 (flight line) maintenance
- Provides routing channels for backplane

### LRM CONNECTORS WITH STAGGERED GRID AIRFLOW-THRU CONTACT PATTERN

- Accommodate standard B<sup>3</sup> tails in staggered pattern, but with increased spacing in the center, and also provide more airflow cooling of inserts; for use with wider boards, up to 0.425 inch



STAGGERED GRID LRM CONNECTORS

180 Brush contacts in a Staggered Grid module insert mounted to a PC Board

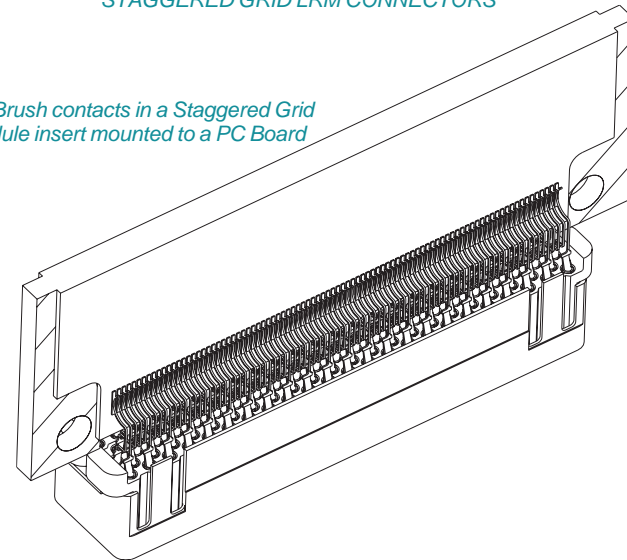

GEN-X GRID LRM CONNECTOR

### LRM CONNECTORS WITH GEN-X GRID

- Even higher contact density than staggered grid and improved electrical performance
- All the feature of the 180 contact pattern, including ESD protection
- Available in SEM-E and custom form factors
- 236 contact pattern grid in 8 rows: 0.075 inch spacing along the row with 0.060 inch between rows, rows offset 0.0375 inch

\* Amphenol LRM Catalog, 12-037, is on-line at [www.amphenol-aerospace.com](http://www.amphenol-aerospace.com). Please note that Amphenol's New Combined Rectangular Catalog (available Jan. 2011) will include LRM interconnects. Call Amphenol Aerospace (800-678-0141) for more information.

# Other Brush Contact Rectangular Connectors

## LRM Hybrids and High Speed LRM Gigastak & Digastak Inserts

### LRM OPTIONAL HYBRID DESIGNS

- Custom combinations of digital contacts and fiber optic termini. Optical performance of fiber optic termini within LRM connectors are the same as termini used in cylindrical connectors.\*\* Insertion losses range from .3dB to <1.5dB depending upon launch conditions, fiber NA, fiber size and the type of termination. LRM connectors are available with fiber optic termini in the following configurations:
  - Modified MIL-PRF-29504/4, /5, MIL-PRF-14 & MIL-PF-15 termini - size 16, straight and 90 degree styles
  - MT ferrule (2-24 fiber lines per ferrule)
  - Hybrid arrangements with fiber optic and other contact types
- LRM inserts with RF contacts
- LRM power supply modules with 270VDC sections which are capable of providing corona-free operation at 100,000 ft.
- Designs with high speed shielded contacts - coax, triax, twinax, differential twinax, and quadrx contacts
- Combinations of power contact, standard brush, high power, differential pair brush and fiber optic termini
- New designs that utilizes the RADSOK® high amperage socket contact with inserts. The RADSOK® design is a socket cylinder within the female contact which has several equally spaced longitudinal beams twisted into a hyperbolic shape. As the male pin is inserted, axial members in the female half deflect, imparting high current flow across the connection with minimal voltage loss. This twisted hyperbolic grid ensures a large coaxial, face-to-face surface area engagement.
- Incorporation of flex circuits for more versatility of PC board terminations
- Custom shells with multiple bay configurations
- Backplane shell grounding capabilities



LRM INTERCONNECTS (SHOWN FROM TOP TO BOTTOM):

- LRM Backplane, 2 bays of staggered B<sup>3</sup> brush contacts and inserts for size 12 coax contacts
- LRM Module with Fiber Optic MT ferrules in one insert and B<sup>3</sup> Brush in a differential pair insert
- LRM inserts with PC tails
- LRM mating Module and Backplane with MT-PRF-29504 Fiber optic termini and B<sup>3</sup> Brush contacts

### HIGH SPEED LRM GIGASTAK AND DIGASTAK INSERTS

More and more speed is needed in today's interconnection products. Amphenol has recently developed a new family of high speed LRM connectors that are capable of achieving data rates in excess of 6.25 Gbps via 100 ohm matched impedance differential pairs. Each insert arrangement has been optimized through strategic placement of signal and ground contacts for the perfect balance of impedance control and cross talk mitigation for a given data rate. As an enhancement over the standard LRM, this new series offers a unique solderless termination to module cards via Amphenol Intercon's cStack technology.



HIGH SPEED LRM GIGASTAK AND DIGASTAK INSERTS

\*\* For more information on Amphenol fiber optic connectors and termini, see the Fiber Optic section of Amphenol's Combined Circular Interconnects catalog, on-line at [www.amphenol-aerospace.com](http://www.amphenol-aerospace.com).

# Other Amphenol Rectangular Connectors

## Total packaging with Amphenol Printed Circuit Boards, Rectangular and Cylindrical Connectors

### BOARD LEVEL CONNECTORS WITH QUADRAX CONTACTS

Amphenol leads in the electrical connector arena in offering a wide range of interconnects that provide high speed transmission and operate in high frequency conditions. The photo at right shows a board level connector with 4 size 8 quadrax compliant contacts. This will accommodate a backplane of .125 inch min. thickness. Consult Amphenol Aerospace for more information.



BOARD LEVEL CONNECTOR WITH COMPLIANT PIN QUADRAX CONTACTS

### VIPER® INTERCONNECTS

Amphenol Backplane Systems (ABS) developed the VIPER interconnect platform to provide a ruggedized and high density modular connector solution that can scale to higher bandwidths; from 80 Mbps to over 10 Gpbs. Features and benefits of the VIPER include:

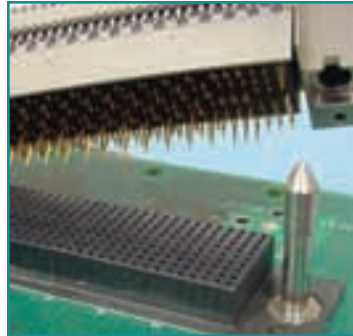

VIPER® CONNECTORS

- Designed for 10+ Gbps data rate performance
- 100 ohm impedance for differential pair in a 1.8mm x 1.35mm grid
- Press-fit termination compliant pins
- Backplane modules available in 8 & 16 row increments, 1.8mm x 1.8mm grid
- Fully footprint-compatible with VITA 46 & VITA 48 standards
- ESD protection

Consult Amphenol Backplane Systems for more information.  
Phone: 603-883-5100

### AMPHENOL PRINTED CIRCUIT BOARD CAPABILITIES

Amphenol Printed Circuits' capabilities are among the world's broadest and most advanced, delivering consistent quality and reliability for demanding high bandwidth systems and mission critical applications. Designs of printed circuit boards are available from Amphenol APC with a wide variety of materials, formation types, panel sizes and layer counts.

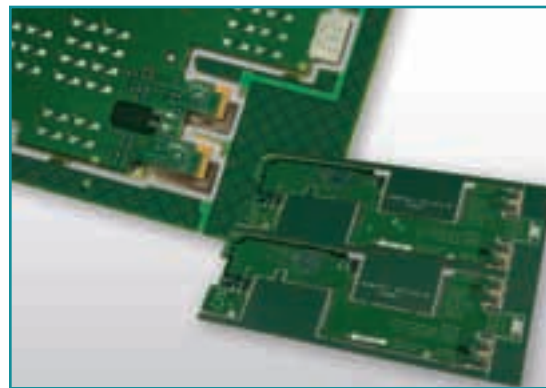

AMPHENOL PRINTED CIRCUIT BOARDS

### AMPHENOL FLEX CIRCUIT ASSEMBLIES

Amphenol Printed Circuits' capabilities also includes the design and manufacture of flex circuits used to attach cylindrical and rectangular connectors to PCB boards. Sculptured® Flexible Circuits with built-in terminations eliminate the failures associated with crimped or soldered-on contacts. Flex geometrically fits tight space requirements and eliminates the need to purchase and attach individual pins or connectors.

Consult APC, Amphenol Printed Circuits, for more information on printed circuit boards and flex assemblies. Phone: 603-324-4500



FLEX CIRCUITRY WITH RECTANGULAR CONNECTORS

### INTEGRATED SYSTEM PACKAGING

Amphenol can provide system solutions - everything you need inside and outside the box: Interconnect products, printed circuit boards, backplane assemblies, heat-sinks and metal enclosures. Amphenol also provides value added assembly including bussing; full system assembly including chassis build and sub-system integration and testing. The breadth of Amphenol's products and the proven expertise of being a world-wide interconnect product leader makes Amphenol the premier choice for system-level packaging. For more information on integrated systems, call:

Amphenol Aerospace at 800-678-0141  
Amphenol Backplane Systems at 888-318-3553

An example integrated system box, shown at right, includes the following Amphenol interconnect products:

- Circulars: D38999 cylindrical connectors with MT fiber optics, RJ Field connectors
- Rectangulars: LRM interconnects, NAFI connectors, UHD connectors
- Rectangulars: ARINC 600 connectors, Micro-D Subminiature connectors
- Rectangulars: HDB3 high density brush contact connectors
- Backplane Systems, Flex Circuitry, metal enclosure

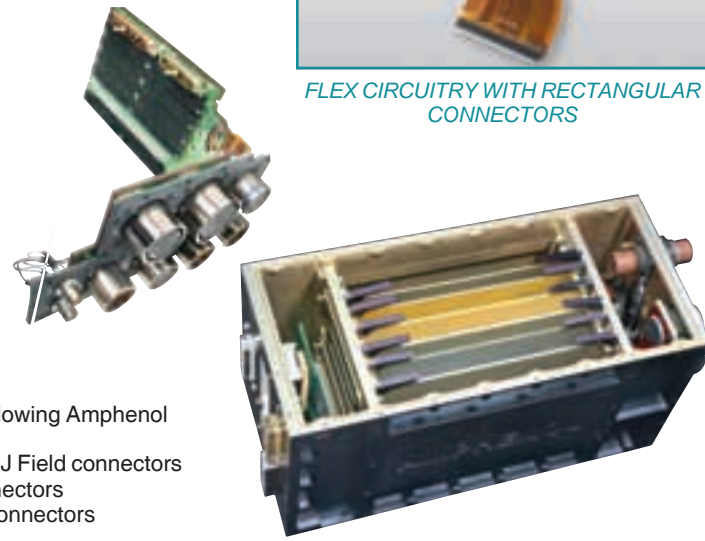

AMPHENOL INTEGRATED SYSTEMS

## X-ON Electronics

Largest Supplier of Electrical and Electronic Components

*Click to view similar products for [Rectangular MIL Spec Connectors](#) category:*

*Click to view products by [Amphenol](#) manufacturer:*

Other Similar products are found below :

[006-1169-16](#) [CSR31343-0001-00000](#) [CSR31346-0001-A0001](#) [CSR31899-0001-00000](#) [CSR31900-0001-A0001](#) [CTJ-3D-05](#) [CTS-S16/16](#)  
[M55302/57A36X](#) [M55302/58-A70Y](#) [65002-062](#) [65008-D08](#) [CY4602-000](#) [732-8020-01](#) [732-8021-02 B](#) [77058-22-55PN](#) [81542-20](#)  
[86.030.0053.0](#) [1241346-1](#) [RM252-020-311-2900](#) [DMC-M 08-16 SNE](#) [1589051-4](#) [BACC65CAMA](#) [BACC65CAMN](#) [BACC65CP1PN](#)  
[BACI10BC1220PN](#) [18023-9](#) [HSB-D4S03DM222X](#) [2217548-1](#) [891-009-15SA2-BRT1T](#) [SIM2S100A](#) [1604996-2](#) [SMD25PN90L-4055](#)  
[1925036-4](#) [220A012-25225-0](#) [22628-10-6P-791](#) [CSR31343-0001-A0001](#) [CSR31899-0001-A0001](#) [CSR31900-0001-00000](#) [33526M11-08PD](#)  
[RE04-212S](#) [CTD160E01F-6148](#) [CTJ112E03B](#) [CTJ122E02D-8000](#) [CTJ-3D-12](#) [CTJ920E06N-513](#) [CTJ920E12N-513](#) [CTL-16-090](#) [CTR06-](#)  
[5100SY](#) [M55302/63A20H](#) [M55302/66-30H](#)