

REVISIONS					
REV	ECO	DESCRIPTION	DATE	BY	APPR
B1	-	RELEASE NEW DWG FORMAT	Jul.15,2014	Tod	Tommy
B2	-	UPDATE THE DURABILITY	Jun.27,2015	Drack	Tommy
B3	-	UPDATED	04DEC15	MRF	Tommy

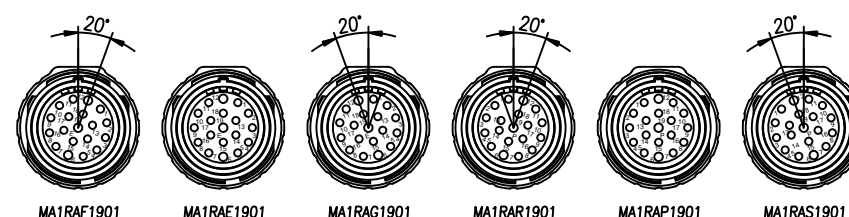
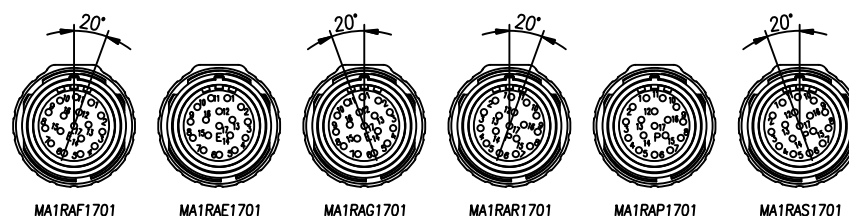
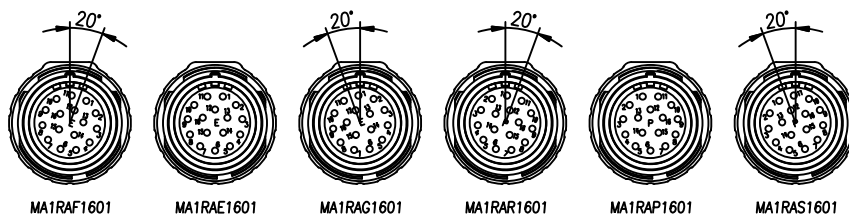
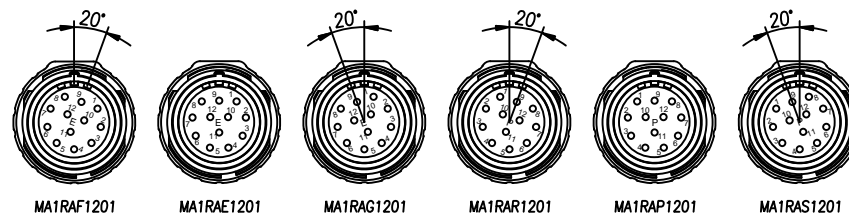
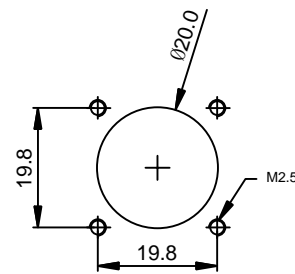
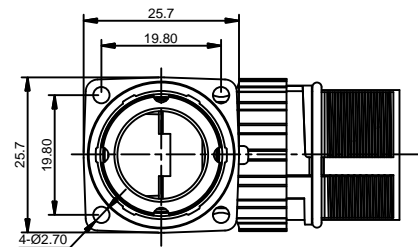
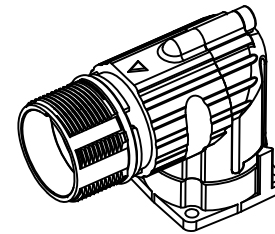
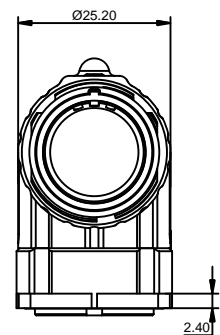
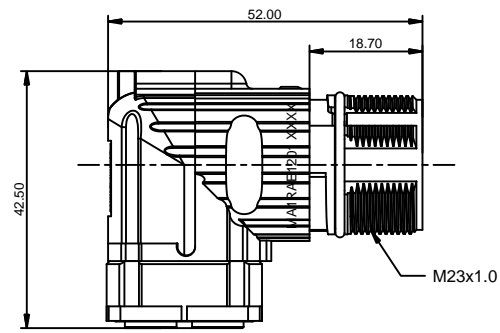

REV	ECO	DESCRIPTION	DATE	BY	APPR
-		MA1RAS1901	M23, RECP, R/A, ROT, 19POS, P TYPE, KEYED "S"		27
-		MA1RAR1901	M23, RECP, R/A, ROT, 19POS, P TYPE, KEYED "R"		26
-		MA1RAP1901	M23, RECP, R/A, ROT, 19POS, P TYPE		25
-		MA1RAG1901	M23, RECP, R/A, ROT, 19POS, E TYPE, KEYED "G"		24
-		MA1RAF1901	M23, RECP, R/A, ROT, 19POS, E TYPE, KEYED "F"		23
-		MA1RAE1901	M23, RECP, R/A, ROT, 19POS, E TYPE		22
-		MA1RAS1701	M23, RECP, R/A, ROT, 17POS, P TYPE, KEYED "S"		21
-		MA1RAR1701	M23, RECP, R/A, ROT, 17POS, P TYPE, KEYED "R"		20
-		MA1RAP1701	M23, RECP, R/A, ROT, 17POS, P TYPE		19
-		MA1RAG1701	M23, RECP, R/A, ROT, 17POS, E TYPE, KEYED "G"		18
-		MA1RAF1701	M23, RECP, R/A, ROT, 17POS, E TYPE, KEYED "F"		17
-		MA1RAE1701	M23, RECP, R/A, ROT, 17POS, E TYPE		16
-		MA1RAS1601	M23, RECP, R/A, ROT, 16POS, P TYPE, KEYED "S"		15
-		MA1RAR1601	M23, RECP, R/A, ROT, 16POS, P TYPE, KEYED "R"		14
-		MA1RAP1601	M23, RECP, R/A, ROT, 16POS, P TYPE		13
-		MA1RAG1601	M23, RECP, R/A, ROT, 16POS, E TYPE, KEYED "G"		12
-		MA1RAF1601	M23, RECP, R/A, ROT, 16POS, E TYPE, KEYED "F"		11
-		MA1RAE1601	M23, RECP, R/A, ROT, 16POS, E TYPE		10
-		MA1RAS1201	M23, RECP, R/A, ROT, 12POS, P TYPE, KEYED "S"		9
-		MA1RAR1201	M23, RECP, R/A, ROT, 12POS, P TYPE, KEYED "R"		8
-		MA1RAP1201	M23, RECP, R/A, ROT, 12POS, P TYPE		7
-		MA1RAG1201	M23, RECP, R/A, ROT, 12POS, E TYPE, KEYED "G"		6
-		MA1RAF1201	M23, RECP, R/A, ROT, 12POS, E TYPE, KEYED "F"		5
-		MA1RAE1201	M23, RECP, R/A, ROT, 12POS, E TYPE		4
QUANTITY	PART NUMBER	DESCRIPTION	ITEM		

MATERIALS LIST

UNLESS OTHERWISE SPECIFIED 1) All dimensions are in metric(mm). 2) Tolerances are as follows: 1 PL DEC ±0.30 2 PL DEC ±0.15 3 PL DEC ±0.08 3) Note reference =	SIGNATURES DRAWN: Drack CHECKED: ENGINEER: APPROVAL:	DATE Jun.27,2015	<h1>Amphenol</h1> <p>Sine Systems - www.amphenol-sine.com 44724 Morley Drive Clinton Township, MI 48036</p>		
MATERIAL SPECIFICATIONS:	CUSTOMER:				
PROCESS SPECIFICATIONS:	THIS DRAWING IS SUPPLIED FOR INFORMATION ONLY. DESIGN FEATURES, SPECIFICATIONS AND PERFORMANCE DATA SHOWN HEREON ARE THE PROPERTY OF THE AMPHENOL CORPORATION. NO RIGHTS OF REPRODUCTION ARE IMPLIED. ALL DIMENSIONS ARE SUBJECT TO NORMAL MANUFACTURING VARIATIONS.		SIZE B C-	DWG NO. MA1Rxxx01	REVISION B3
NEXT ASSY:	SCALE: NONE	C-MA1Rxxx01	SHEET 1	OF 1	

NOTES: UNLESS OTHERWISE SPECIFIED

- MATERIAL:
INSULATION INSERT: PA66,UL94 V0
SEAL: VITON
HOUSING BODY: ZINC DIE CAST, NICKEL PLATED
- SPECIFICATIONS:
2.1 CURRENT RATING: 10 AMPS - 12 POSITION
9 AMPS - 16 POSITION
9 AMPS - 17 POSITION
7 AMPS - 19 POSITION
2.2 VOLTAGE RATING: 160V AC/DC - 12 POSITION
125V AC/DC - 16 POSITION
125V AC/DC - 17 POSITION
63V AC/DC - 19 POSITION
2.3 OPERATING TEMPERATURE: -20°C TO +130°C
2.4 DIELECTRIC WITHSTANDING VOLTAGE: LESS THAN 2 MILLIAMPS CURRENT LEAKAGE @ 2500 VOLTS AC.
2.5 DEGREE OF PROTECTION: IP67 (MATED CONDITION)
2.6 DEGREE OF POLLUTION: 3 PER UL840
2.7 OVERVOLTAGE CATEGORY: III PER UL840
2.8 MATING CYCLE DURABILITY: >500 CYCLES
2.9 RoHS COMPLIANT
- ALL DIMENSIONS ARE FOR REFERENCE USE ONLY.

TITLE: M23 RECEPTACLE, ANGLED, ROTATABLE, THREADED
DWG NO: MA1Rxxx01
REV: B3
SH: 1
OF: 1

X-ON Electronics

Largest Supplier of Electrical and Electronic Components

Click to view similar products for [amphenol manufacturer](#):

Other Similar products are found below :

[CTV06RGQF-17-52P](#) [CTVPS00RGF-23-6P-LC](#) [GC835TY2S](#) [CF-509621-29P](#) [BF8-1218-31SV-Y70](#) [TVP00RGW-23-6SA\(LC\)](#)
[RNJ27CI1535P014](#) [10-553998-139](#) [21-033388-031](#) [10-507142-843](#) [GTS06G-32-7S](#) [GTC06-36-78PX-023](#) [ACC02E28-51S-003-B30-LC](#)
[TV06RL-13-35SD-LC](#) [TV06RL-13-35SD](#) [TV06RL-13-98SD-LC](#) [TV06RL-13-98SD](#) [GTC08AF32-15SX-B30-LC](#) [GTC06G32-76PZ](#)
[TVP00RW-23-53AD](#) [100-007-213-002-001](#) [5M30-61](#) [FSPP-103-00-004](#) [360031](#) [10-037090-161](#) [10-541504-001](#) [10-580902-409](#) [TV97RW-](#)
[9-9S\(S15\)](#) [TVPS00RGF-9-5P-LC](#) [TVPS00RGF-9-5PA-LC](#) [TVP00RGQW-21-75P-LC](#) [TV06RW-25-90AE](#) [97-3108B16S-5PW-417](#) [PT06J20-](#)
[24SW](#) [97-3108B16S-4PY-417](#) [97-3108B16S-4PX-417](#) [97-3108B16S-5PY-417](#) [97-3108B16S-4PW-417](#) [CS-DSDMDB37MF-025](#) [97-](#)
[3108B16S-5PZ-417](#) [TV06RW-25-46AE](#) [TVS07RF-21-16AA](#) [TVS07RF-21-39BA](#) [60261626SNCOND1](#) [SE00TVW09](#) [CF-5A9013-04N](#) [CF-](#)
[6A4615-06N](#) [GTS01-22-22PX-025-116](#) [GTS01-22-22P-025-116](#) [GTS01-22-22P-116](#)