

REVISIONS					
REV	ECO	DESCRIPTION	DATE	BY	APPR
B1	-	RELEASE NEW DWG FORMAT	03/14/14	Drack	Tommy
B2	-	UPDATE THE DURABILITY	May.21,2015	Drack	Tommy
B3	-	UPDATED	04DEC15	MRF	Tommy
B4	-	UPDATED NUT	20APR16	MRF	Tommy

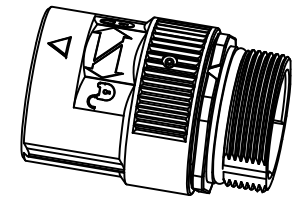
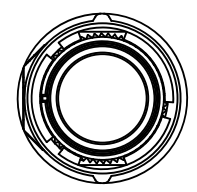
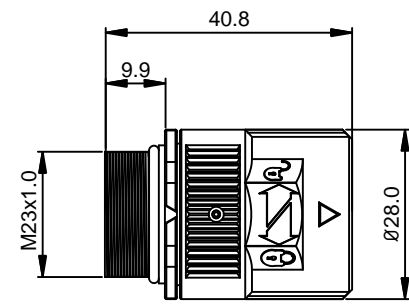

REV	ECO	DESCRIPTION	DATE	BY	APPR
-		MA2CAS1900	M23, PLUG, ST, 19POS, P TYPE, KEYED "S"		27
-		MA2CAR1900	M23, PLUG, ST, 19POS, P TYPE, KEYED "R"		26
-		MA2CAP1900	M23, PLUG, ST, 19POS, P TYPE		25
-		MA2CAG1900	M23, PLUG, ST, 19POS, E TYPE, KEYED "G"		24
-		MA2CAF1900	M23, PLUG, ST, 19POS, E TYPE, KEYED "F"		23
-		MA2CAE1900	M23, PLUG, ST, 19POS, E TYPE		22
-		MA2CAS1700	M23, PLUG, ST, 17POS, P TYPE, KEYED "S"		20
-		MA2CAR1700	M23, PLUG, ST, 17POS, P TYPE, KEYED "R"		19
-		MA2CAP1700	M23, PLUG, ST, 17POS, P TYPE		18
-		MA2CAG1700	M23, PLUG, ST, 17POS, E TYPE, KEYED "G"		17
-		MA2CAF1700	M23, PLUG, ST, 17POS, E TYPE, KEYED "F"		16
-		MA2CAE1700	M23, PLUG, ST, 17POS, E TYPE		15
-		MA2CAS1600	M23, PLUG, ST, 16POS, P TYPE, KEYED "S"		13
-		MA2CAR1600	M23, PLUG, ST, 16POS, P TYPE, KEYED "R"		12
-		MA2CAP1600	M23, PLUG, ST, 16POS, P TYPE		11
-		MA2CAG1600	M23, PLUG, ST, 16POS, E TYPE, KEYED "G"		10
-		MA2CAF1600	M23, PLUG, ST, 16POS, E TYPE, KEYED "F"		9
-		MA2CAE1600	M23, PLUG, ST, 16POS, E TYPE		8
-		MA2CAS1200	M23, PLUG, ST, 12POS, P TYPE, KEYED "S"		6
-		MA2CAR1200	M23, PLUG, ST, 12POS, P TYPE, KEYED "R"		5
-		MA2CAP1200	M23, PLUG, ST, 12POS, P TYPE		4
-		MA2CAG1200	M23, PLUG, ST, 12POS, E TYPE, KEYED "G"		3
-		MA2CAF1200	M23, PLUG, ST, 12POS, E TYPE, KEYED "F"		2
-		MA2CAE1200	M23, PLUG, ST, 12POS, E TYPE		1

QUANTITY	PART NUMBER	DESCRIPTION	ITEM
----------	-------------	-------------	------

MATERIALS LIST			
UNLESS OTHERWISE SPECIFIED		SIGNATURES	DATE
1) All dimensions are in metric(mm).		DRAWN: Drack	May.21,2015
2) Tolerances are as follows:		CHECKED:	
1 PL DEC ±0.30		ENGINEER:	
2 PL DEC ±0.15		APPROVAL:	
3 PL DEC ±0.08		CUSTOMER:	
3) Note reference =		THIS DRAWING IS SUPPLIED FOR INFORMATION ONLY. DESIGN FEATURES, SPECIFICATIONS AND PERFORMANCE DATA SHOWN HEREON ARE THE PROPERTY OF THE AMPHENOL CORPORATION. NO RIGHTS OF REPRODUCTION ARE IMPLIED. ALL DIMENSIONS ARE SUBJECT TO NORMAL MANUFACTURING VARIATIONS.	
MATERIAL SPECIFICATIONS:		SIZE: B C- DWG NO: MA2CAxxx00 REVISION: B4	
PROCESS SPECIFICATIONS:		SCALE: NONE C-MA2CAxxx00 SHEET 1 OF 1	
NEXT ASSY:			

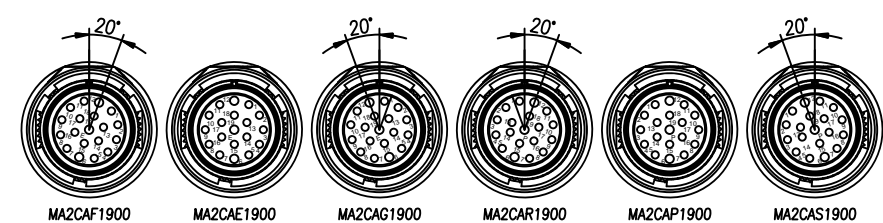
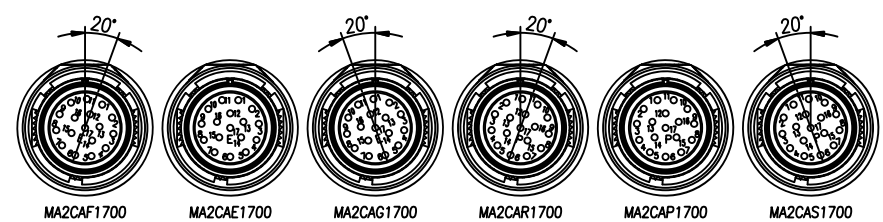
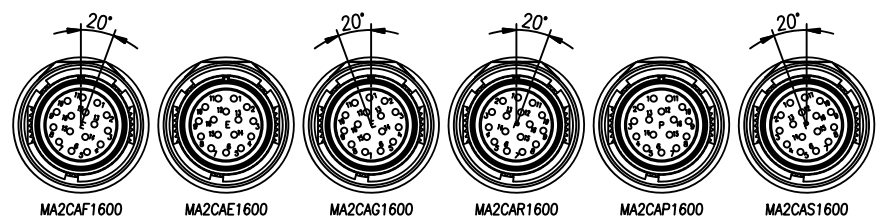
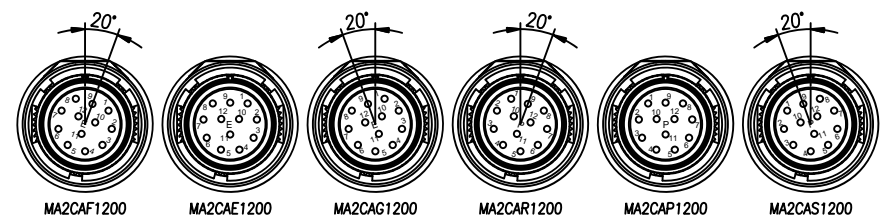

- NOTES: UNLESS OTHERWISE SPECIFIED
- MATERIAL:
 - INSULATION INSERT: PA66,UL94 V0
 - SEAL: VITON
 - HOUSING BODY: ZINC DIE CAST, NICKEL PLATED
 - COUPLING NUT: ZINC DIE CAST, NICKEL PLATED
 - SPECIFICATIONS:
 - CURRENT RATING: 10 AMPS - 12 POSITION
9 AMPS - 16 POSITION
9 AMPS - 17 POSITION
7 AMPS - 19 POSITION
 - VOLTAGE RATING: 160V AC/DC - 12 POSITION
125V AC/DC - 16 POSITION
125V AC/DC - 17 POSITION
63V AC/DC - 19 POSITION
 - OPERATING TEMPERATURE: -20°C TO +130°C
 - DIELECTRIC WITHSTANDING VOLTAGE: LESS THAN 2 MILLIAMPS CURRENT LEAKAGE @ 2500 VOLTS AC.
 - DEGREE OF PROTECTION: IP67 (MATED CONDITION)
 - DEGREE OF POLLUTION: 3 PER UL840
 - OVERVOLTAGE CATEGORY: III PER UL840
 - MATING CYCLE DURABILITY: >500 CYCLES
 - RoHS COMPLIANT
 - ALL DIMENSIONS ARE FOR REFERENCE USE ONLY.

TITLE: M23 PLUG, STRAIGHT, CHECKMATE
 DWG NO: MA2CAxxx00
 REV: B4
 SH: 1
 OF: 1

X-ON Electronics

Largest Supplier of Electrical and Electronic Components

Click to view similar products for [Circular Metric Connectors](#) category:

Click to view products by [Amphenol](#) manufacturer:

Other Similar products are found below :

[1424048](#) [1021212](#) [600X518037X](#) [6STD09SAM99B70X](#) [6STD15PCR99B70A](#) [1200910002](#) [1203580030](#) [1200700064](#) [1200700263](#)
[1200700416](#) [1200730102](#) [1200770002](#) [1-2823588-2](#) [130203-0054](#) [1300140026](#) [1300150099](#) [1-3637-600-5205](#) [1545399](#) [1594331](#) [1600413](#)
[1612606](#) [1612618](#) [1614660](#) [1A4000-348](#) [21036836414](#) [2823064-1](#) [1610759](#) [1R3006A20M005](#) [41-01016](#) [41-40011](#) [41-40017](#) [42-00006](#) [42-](#)
[01015](#) [4-22279-4](#) [4-22281-1](#) [4-22284-9](#) [43-00002](#) [43-00113](#) [43-00130](#) [43-01028](#) [43-01034](#) [43-01090](#) [43-01203](#) [43-01209](#) [43-01335](#)
[CA06EA2219S](#) [CA3101ER2214P](#) [CA3106R14S-7S-F80-A95](#) [41-40005](#) [41-40013](#)