

CONSISTENT PRODUCT RELIABILITY

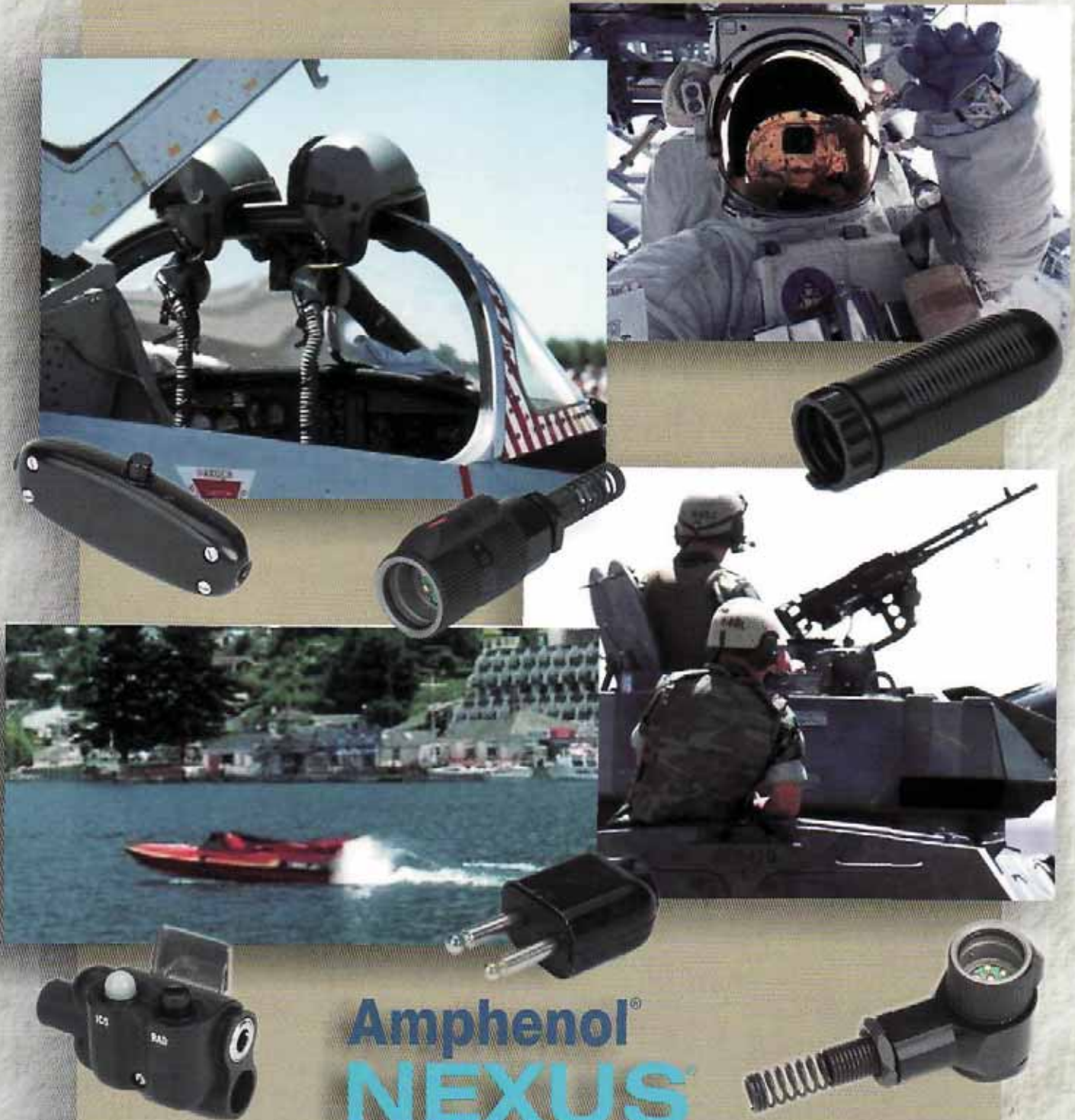

Amphenol[®]
NEXUS
Technologies

- ✓ Audio Frequency Plugs & Jacks
- ✓ Push-Button Switches
- ✓ Miniature Series

PROBLEM SOLVER.

NEXUS, Incorporated was established in 1961 and was purchased by Amphenol Corporation in July, 2008. Amphenol NEXUS Technologies offers design and production of superior quality audio plugs, jacks and momentary push-button switches.

Nexus Connectors:

- specified in OEM headset applications where “breakaway-style” audio connectors are required
- the standard in military/commercial communication headset markets

Nexus Switches:

- strong, “tactile-feedback” feature
- designed for applications that require durable, reliable and cost-effective switching

Applications:

- Military
- Commercial Aviation Electronics
- Medical Products
- Telecommunications
- Simulation Controls
- Auto Racing
- Powerboat Racing
- Farm Equipment



OMJ-101

PROBLEM: Our customer wanted to overmold a miniature 2-pin jack, but due to the special shape of the contacts, was unable to do this.

SOLUTION: We used stamping and molding processes and were able to deliver a solution that met their needs.



117 Series

PROBLEM: A company had our 7 pin full size environmentally sealed connector in mind when they approached us seeking a smaller version to fit their applications.

SOLUTION: We were able to reduce the size by 50% and also maintain the same properties as the larger version.



SOLVED.

TP-120

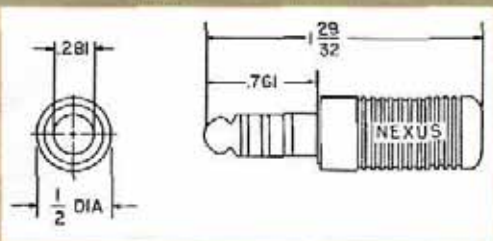

Four Conductor Telephone Plug

Mates with Nexus Series TJ-120, TJ-102, TJT-102, TJS-102, and TJ-101 jacks. One piece nickel plated brass contacts are integrally molded into plastic body.

TP-120-5

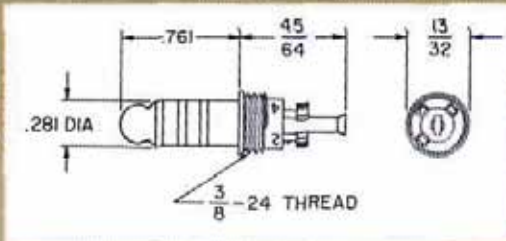

Four Conductor Telephone Plug

Mates with Nexus Series TJ-120, TJ-102, TJT-102, TJS-102, and TJ-101 jacks. For custom molding directly to cable. Same as TP-120-7 but strain relief clip omitted.

TP-120-7

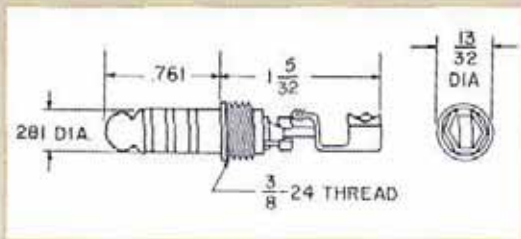

Four Conductor Telephone Plug

Mates with Nexus Series TJ-120, TJ-102, TJT-102, TJS-102, and TJ-101 jacks. For custom molding directly to cable. Same as TP-120 but without plastic shell.

TJ-120

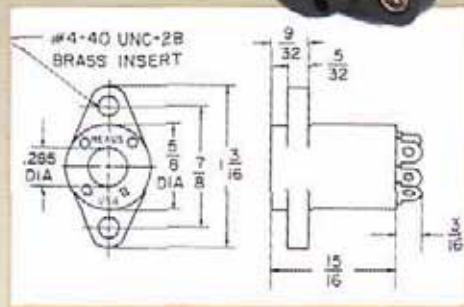

Flanged Rear-Mounted Jack

Mates with Nexus Series TP-120, TP-101, TP-102, and TPSJ-101 plugs. Nickel plated beryllium contacts are anchored in a phenolic body.

CUSTOM SPECS We have the capabilities to make custom variations to meet your specific needs. Call us for the latest design solutions that we offer!



**TJG-120 and
TJS-120**

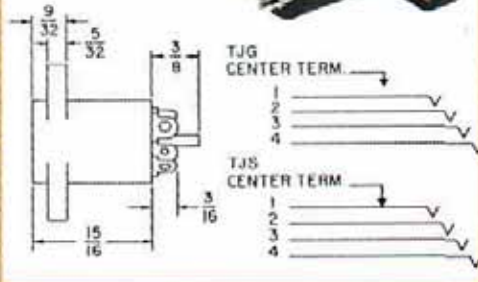

Flanged Rear-Mounted Jacks with Switches
Mates with Nexus Series TP-120, TP-101 and TP-102 plugs. A fifth contact has been added to the TJ-120 design in a normally open circuit with the No. 1 contact to make the TJG-120. Insertion of a four conductor plug closes the No. 1-5 contact circuit. The TJS-120 is the same as TJG-120 except the fifth, or switching contact is normally in a closed circuit with the No. 1 contact. Insertion of a four conductor plug opens the No. 1-5 contact circuit.

TJT-120

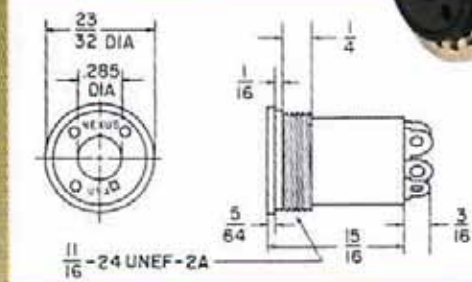

Threaded Front-Mounted Jack
Mates with Nexus Series TP-120, TP-101 and TP-102 plugs. Same material and construction as the TJ-120. Jack housing is threaded for front mounting by screwing into threaded mounting hole or by inserting into front of panel and securing with nut and lockwasher from behind. Please specify nut and lock washer when ordering.

**TJGT-120 and
TJST-120**

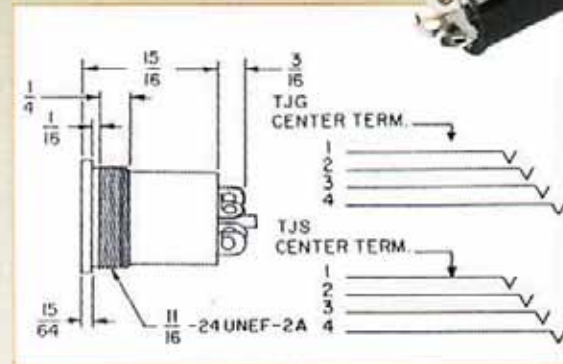

Threaded Front-Mounted Jack With Switches
Mates with Nexus Series TP-120, TP-101 and TP-102 plugs. A fifth contact has been added to the TJT-120 design in a normally open circuit with the No. 1 contact to make the TJGT-120. Insertion of a four conductor plug closes the No. 1-5 contact circuit. The TJST-120 is the same as TJGT-120 except the fifth or switching contact is in a normally closed circuit with the No. 1 contact. Insertion of a four conductor plug opens the No. 1-5 contact circuit.

Standard plugs and jacks are available for prompt shipment.

Suggested wiring sequences for telephone plugs and jacks are as follows:
For binaural headsets, wire the connector

- Contact #1 Microphone, high
- Contact #2 Left earphone
- Contact #3 Microphone, low
- Contact #4 Right earphone
- Contact #5 Earphones, low

For monaural headsets, wire the connector:

- Contact #1 Microphone, high
- Contact #2 Earphones, high
- Contact #3 Microphone, low
- Contact #4 Earphones, low

**Amphenol®
NEXUS®
Technologies**

TP-101
(U-174/U,
M9177/2-1)

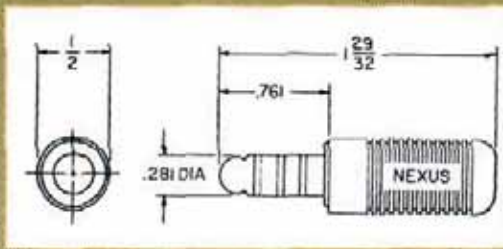

Four Conductor Telephone Plug
Mates with Nexus Series TJ-120, TJ-102, TJT-102, TJS-102, and TJ-101 jacks. One piece metal contacts integrally molded into glass filled nylon plastic.

TPSJ-101

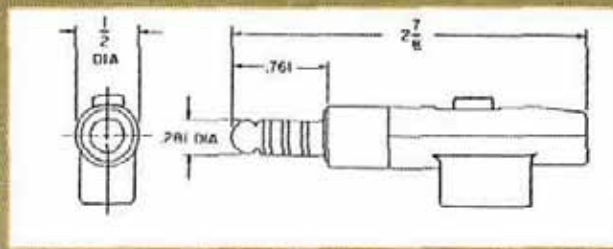

Plug-Switch-Jack Combination
Mates with Nexus Series TJ-120, TJ-102 and TJ-101 jacks. The jack section of the connector mates with a MP-101 plug. Provides the design and electrical characteristics of the TP-101, combined with a manually operated DPDT slide switch and integral two conductor microphone jack.

TP-102
(U-93A/U,
M0177/1-1)

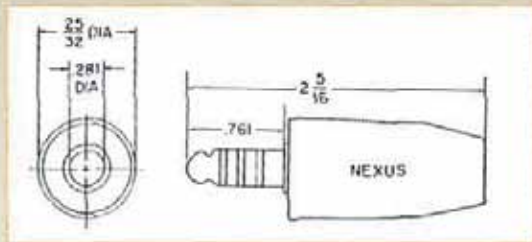

Four Conductor Telephone Plug
Mates with Nexus Series TJ-120, TJ-102, TJT-102, TJS-102, and TJ-101 jacks. Nickel plated brass contacts molded into plastic body. It accommodates larger diameter cable than the TP-101 or TP-120.

TJ-102
(U-92A/U,
M9177/3-1)

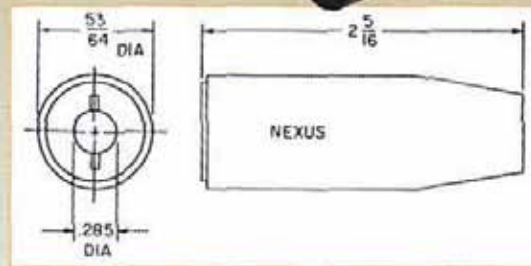

Four Conductor Telephone Jack
Mates with Nexus Series TP-120, TP-101, TPSJ-101 and TP-102 plugs. Nickel plated beryllium contacts are anchored in a glass filled nylon body.

PROBLEM SOLVER.

Customer Support • Engineering
Design Consulting • Quality Assurance



Amphenol®
NEXUS®
Technologies

Tel: 203-327-7300

Fax: 203-324-7623

www.nexus.com

email: salesinfo@nexus.com

Ruggedized Commercial & Military Telephone Plugs & Jacks - Four Conductor

TJT-102
(M9177/4-1)

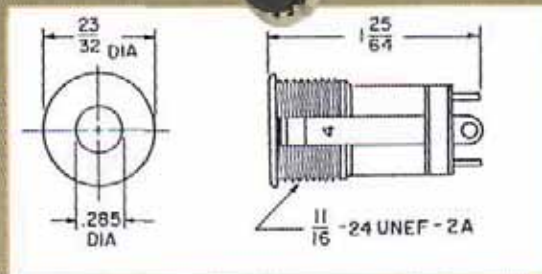

Four Conductor Telephone Jack
Mates with Nexus Series TP-120, TP-101 and TP-102 plugs. A panel mounted version of the TJ-102.

TJ-101

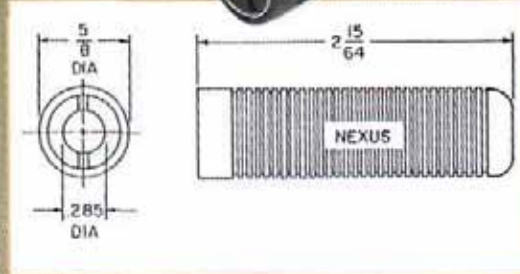

Four Conductor Telephone Jack
Mates with Nexus Series TP-120, TP-101, TPSJ-101 and TP-102 plugs. Nickel plated beryllium copper contacts molded into plastic body.

TJS-102
(U-94/U,
M9177/5-2)

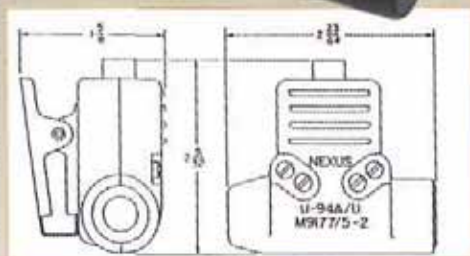

Telephone Jack Switch
Mates with Nexus Series TP-120, TP-101 and TP-102 plugs. Combines a jack similar to TJ-102 with a momentary contact push-button switch and a clothing clip.



Amphenol NEXUS Facilities and Equipment Include:

- CNC Machining
- Thermoset and Thermoplastic Molding Machines
- Stamping Presses
- Numerous Assembly Fixtures
- Heat Treating Equipment
- CAD (Computer Aided Design)
- Tool Room, Testing Lab, Clean Room
- And other Special Proprietary Processes that are designed to manufacture dependable quality products.

Amphenol®
NEXUS
Technologies

TP-105
(U-384/U,
M642/14-01)

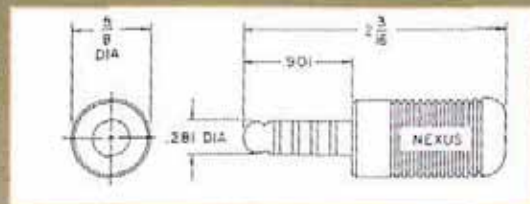

Five Conductor Telephone Plug

Mates with Nexus Series TJ-105 and TJT-125 jacks. One piece metal contacts integrally molded into red plastic body.

TJ-105
(U385/U,
M641/22-01)

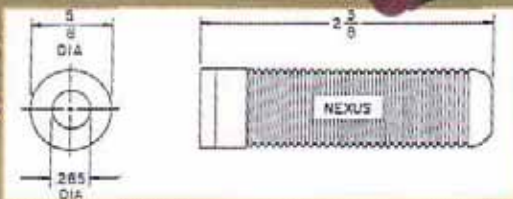

Five Conductor Telephone Jack

Mates with TP-105 plug. Nickel plated beryllium copper contacts molded into red plastic body.

TJT-125

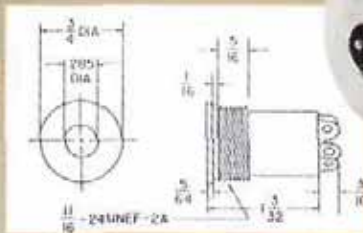

Threaded, Front-Mounted Five Conductor Telephone Jack

Mates with Nexus TP-105 plug. Similar material and construction as TJT-120 jack, but providing 5 contacts. Jack housing is threaded for front-mounting by screwing into mounting hole or by inserting into front of panel and securing by nut and lockwasher from behind. Threaded mounting is contact No. 5.

TJT-105

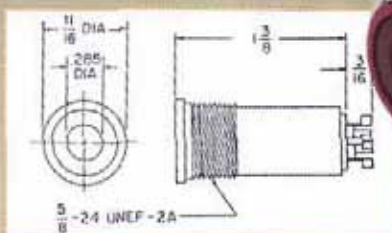

Threaded, Front-Mounted Five Conductor Telephone Jack

Mates with TP-105 plug. Jack housing is threaded for front-mounting by screwing into mounting hole or by inserting into front of panel and securing by nut and lockwasher from behind. All five contact terminations from rear of jack, threaded mounting is not a contact. Nickel plated beryllium copper contacts molded into red plastic body.

TJS-105

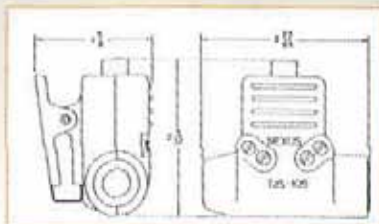

Five Conductor Telephone Jack Switch

Mates with Nexus TP-105 plug. Combines a jack similar to TJ-105 with a momentary contact push-button switch and a clothing clip.

For more information
visit our website
www.nexus.com

All Products
Proudly
Made in U.S.A.



Amphenol®
NEXUS®
Technologies

Your supplier for the complete family of M55116. Please specify cable size -0 through -5.

AP-125
(M55116/1)

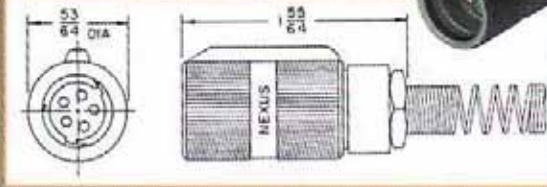

Five Conductor

Wire strain relief, crimp sleeve terminals. Rigid contacts. AP-126 (M55116/2) is the same as the above except with six contacts.

AP-136

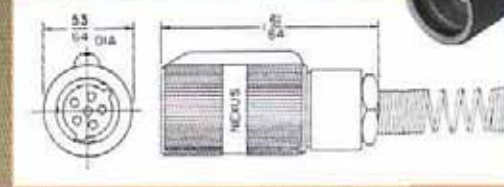

Shielded Six Conductor

Same as AP-126 with provision to terminate shielded cable crimp style. AP-135 is the same as above except it has five contacts. Use AP-176 and AP-175 for solder type contacts.

AP-105
(U-182 B/U)

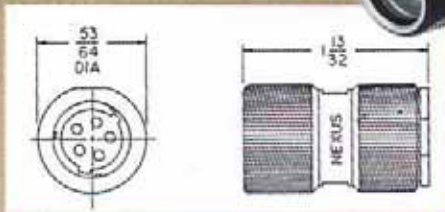

Five Conductor

Mates with U-183/U and U-288/U. Use with molded rubber strain relief. AP-106 is the same as above except it has six contacts.

AP-115
(U-229 B/U)

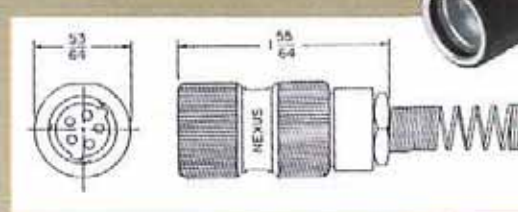

Five Conductor

Mates with U-183/U and U-288/U. Coil spring strain relief. AP-116 is the same as above except it has six contacts.

AP-145M



Five Conductor

Wire strain relief, crimp sleeve terminals with rigid contacts. The AP-146M is the same as above except it has six contacts.

AP-186
(A3167702-2)

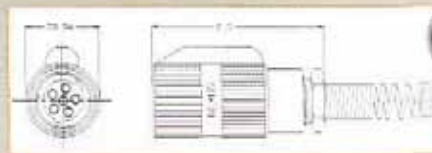

Six Conductor

Wire strain relief, crimp sleeve terminals with rigid contacts.

AP-145 (M55116/3)

Five Conductor

Wire strain relief, solder cup terminals.

AP-155 (M55116/5)

Five Conductor

Molded strain relief, crimp sleeve terminals.

AP-165 (M55116/7)

Five Conductor

Molded strain relief, solder cup terminals.

AP-146 (M55116/4)

Six Conductor

Wire strain relief, solder cup terminals.

AP-156 (M55116/6)

Six Conductor

Molded strain relief, crimp sleeve terminals.

AP-166 (M55116/8)

Six Conductor

Molded strain relief, solder cup terminals.

Amphenol
NEXUS
Technologies

AJ-145
(M55116/9)

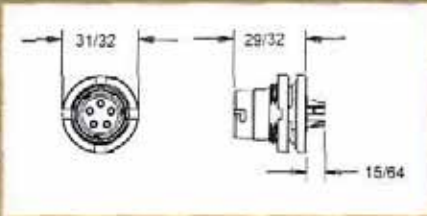

Five Conductor

Panel mount receptacle with spring loaded contacts. Connector includes Nut and O-ring.

AJ-146
(M55116/10)

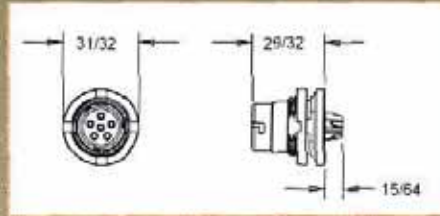

Six Conductor

Panel mount receptacle with spring loaded contacts. Connector includes Nut and O-ring.

AJ-155
(M55116/11)

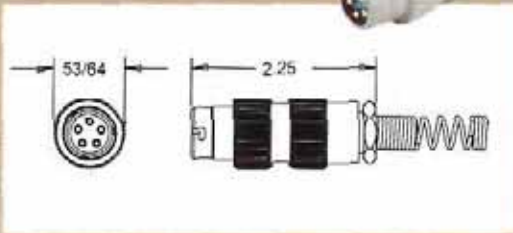

Five Conductor

In-line receptacle with crimp sleeve contacts. Connector includes Wire Cable Strain. AJ-165 (M55116/13) is the same as the above except with solder-cup contacts.

AJ-156
(M55116/12)

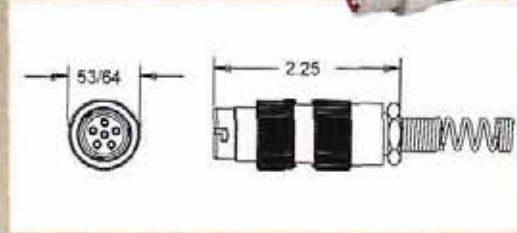

Six Conductor

In-line receptacle with crimp sleeve contacts. Connector includes Wire Cable Strain. AJ-166 (M55116/14) is the same as the above except with solder-cup contacts.

PROBLEM SOLVER.

Your supplier
for the complete family
of M55116.

Amphenol Nexus Technologies has capabilities to supply the complete family of M55116. We are qualified for all slash numbers (/1 through /14) and all dashes (-0 through -5). We are also able to manufacture special modifications of the above connectors including filtered and shielded versions.

AP-136RA



Six Conductor

We re-designed our in-line six pin shielded conductor and added a 90° angle back-end to the connector to redirect the wires. The wire location can be indexed 180°.

Amphenol®
NEXUS®
Technologies

NEW PRODUCTS

MAJ-16-00

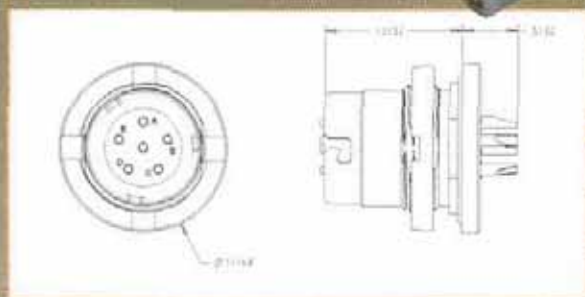

Six Conductor

Panel mount receptacle with spring loaded contacts. Connector includes Nut and O-ring. Mates with MAP-56-30.

MAJ-17-00

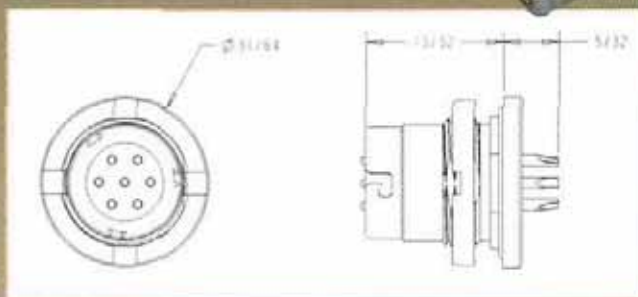

Seven Conductor

Panel mount receptacle with spring loaded contacts. Connector includes Nut and O-ring. Mates with MAP-57-30.

MAP-56-30



Six Conductor

In-line male connector. Mates with MAJ-16-00.

MAP-57-30



Seven Conductor

In-line male connector. Mates with MAJ-17-00.

Connectors shown are set-up with a back shell for .250" cable. We also have the capabilities to accommodate smaller or larger size cable diameters to fit your needs.

**Your Supplier for
Mini Ruggedized Commercial
& Military Audio Plugs
Six and Seven Conductors**

Amphenol Nexus Technologies is proud to announce it's latest six and seven conductor miniature connectors. These connectors are made to exacting specifications of MIL-M55116. We are also able to manufacture special modifications including filtered, shielded, and PC tail contacts. Ensuring that you get a perfect fit, we can make modifications to your specific needs. These connectors meet all electrical and waterproofing requirements and most of the mechanical requirements of M55116.

**Amphenol®
NEXUS®
Technologies**

Tel: 203-327-7300 Fax: 203-324-7623 www.nexus.com email: salesinfo@nexus.com

TP-106

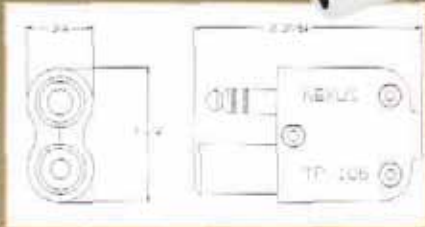

Telephone Plug Bixial Shielded Six Conductor

Mates with Nexus Series TJ-106, TJS-106 and TJSS-106 jacks.

TJ-106

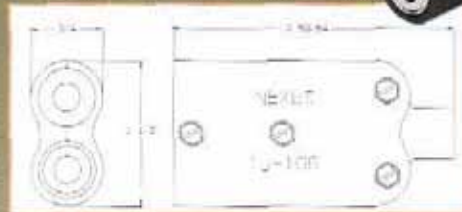

Telephone Jack Bixial Shielded Six Conductor

Mates with Nexus TP-106 plug.

TJ-106PM

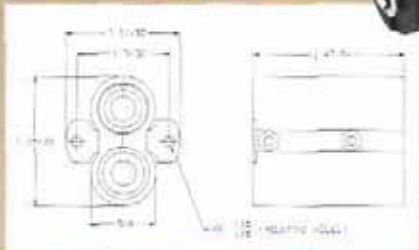

Telephone Jack Bixial Shielded Six Conductor Panel Mount

Mates with Nexus TP-106 plug.

TP-108

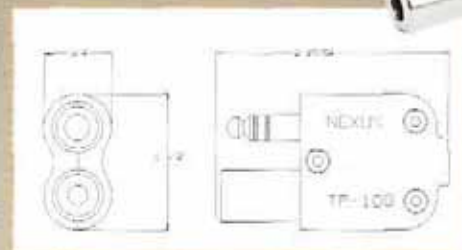

Telephone Plug Bixial Shielded Eight Conductor

Mates with Nexus TJ-108, TJS-108, and TJSS-108 jacks.

TJ-108

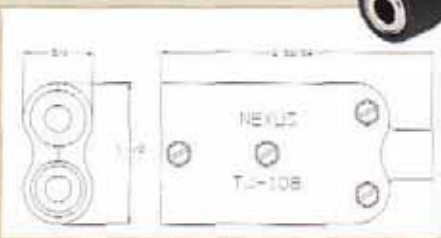

Telephone Plug Bixial Shielded Eight Conductor

Mates with Nexus TP-108 plug.

TJ-108PM

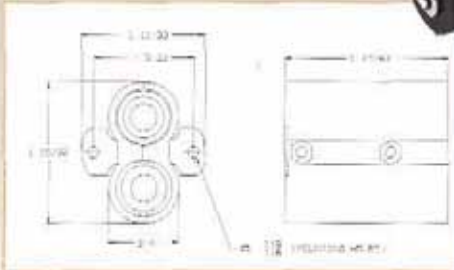

Telephone Jack Bixial Shielded Eight Conductor Panel Mount

Mates with Nexus TP-108 plug.

Amphenol®
NEXUS™
Technologies

TJS-106

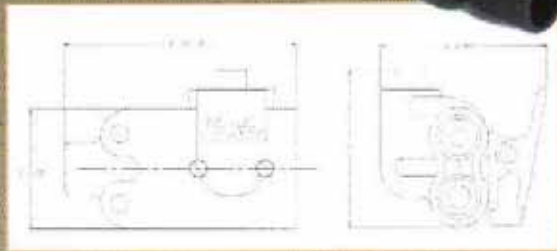

Telephone Jack Switch Bixial Shielded Six Conductor
Mates with TP-106 plug.

TJSS-106

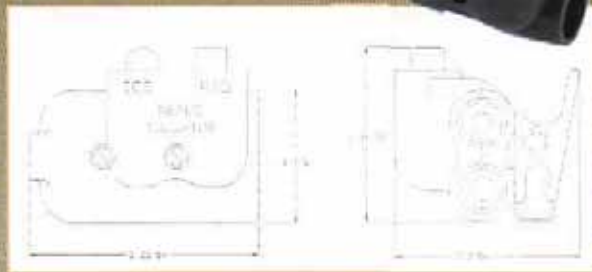

Telephone Jack, Two Switches Bixial Shielded, Six Conductor
Mates with Nexus Series TP-106 plug.

TJS-108

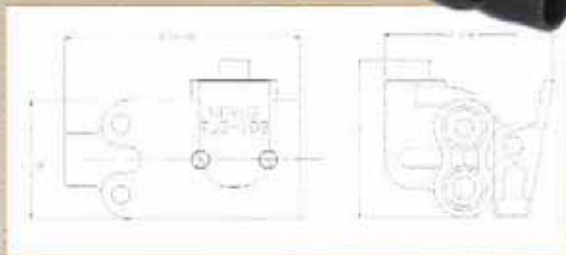

Telephone Jack Switch Bixial Shielded Eight Conductor
Mates with Nexus TP-108 plug.

TJSS-108

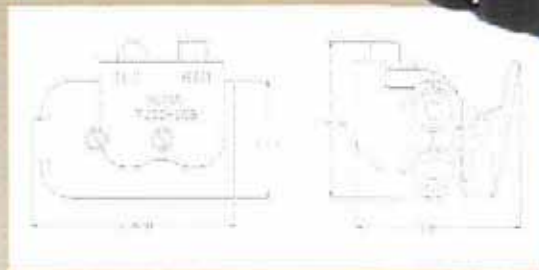

Telephone Jack, Two Switches Bixial Shielded, Eight Conductor
Mates with Nexus TP-108 plug.

PROBLEM SOLVER.

Amphenol Nexus Technologies developed these connectors at the request of our customer to meet special project requirements of Tempest. We have the engineering capability to design connectors and electro-mechanical devices to meet special applications. We welcome your inquiries!

Amphenol®
NEXUS®
Technologies

MP-101
(U-173/U)

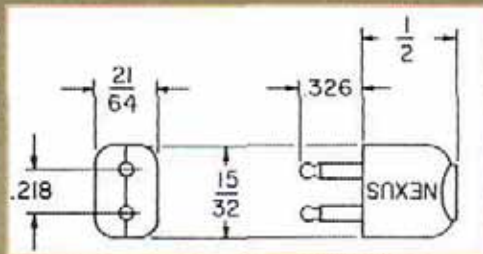

Two Pin Microphone Plug

Mates with Nexus MJ-101, MJ-102, MJ-122, MJ-132, MJ-112, and TPSJ-101 two conductor jacks.
Nickel plated beryllium copper contacts assemble into nylon body.

MJ-101
(U-172/U)

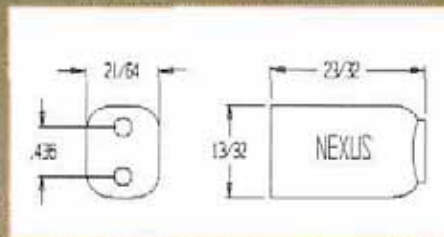

Two Conductor Microphone Jack

Mates with Nexus MP-101 two conductor plug.
Nickel plated beryllium copper contacts assemble into nylon body.

MJ-102
(U-179A/U)

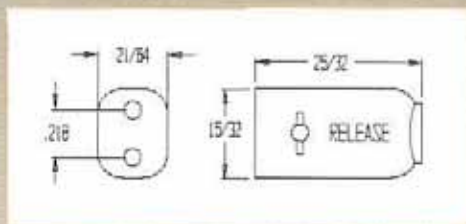

Two Conductor Microphone Locking Jack

Mates with Nexus MP-101 two conductor plug.
Similar to MJ-101 jack in electrical and material characteristics, but with spring-actuated locking design and manual button release.

MJ-112

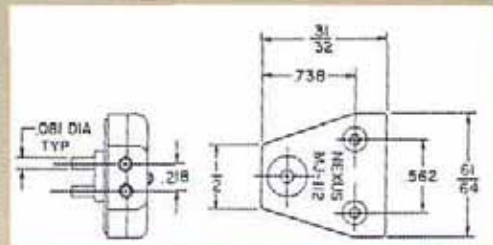

Two Conductor Microphone Jack

Mates with Nexus MP-101 two conductor plug.
Special oxygen mask connector, nickel plated beryllium copper contacts, spring-actuated locking design and manual button release. Assembled in ABS body.



MOLDING

Amphenol®
NEXUS®
Technologies

MJ-122
(JJ-055)

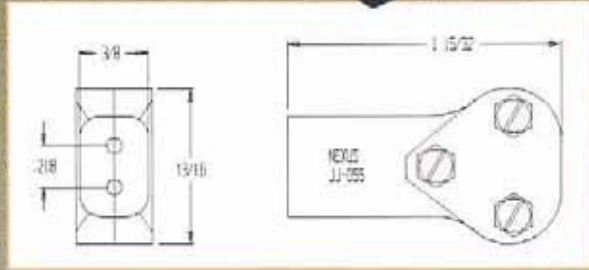

Two Conductor Microphone Jack
Mates with PJ-291, PJ-292 and Nexus MP-101 two conductor plugs. Nickel plated beryllium copper contacts assemble into glass filled nylon body.

MJ-132
(JJ-055)

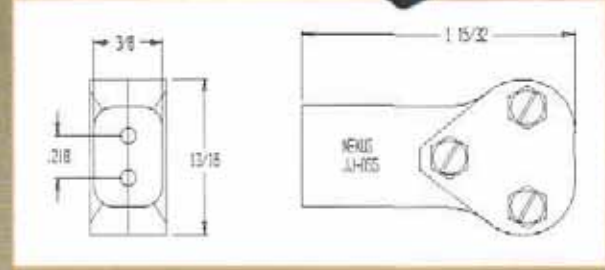

Two Conductor Microphone Jack
Identical to MJ-122 except used with smaller diameter cable.



CUSTOMER SERVICE

PROBLEM SOLVERS.

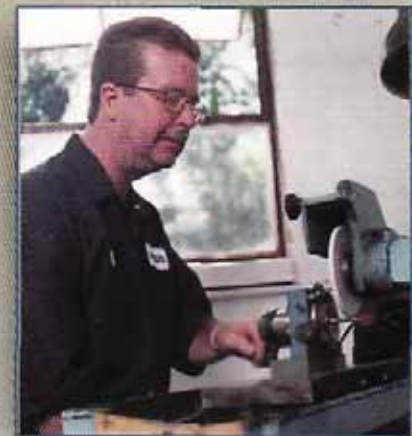

IN-HOUSE TOOLING



TESTING LAB

Amphenol®
NEXUS®
Technologies

MP-103

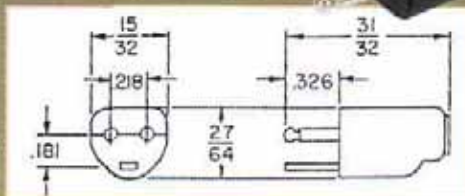

Microphone Plug, Three Conductor
Mates with Nexus MJ-103 microphone jack three conductor. Nickel plated beryllium copper and brass contacts assemble into nylon body.

MJ-103

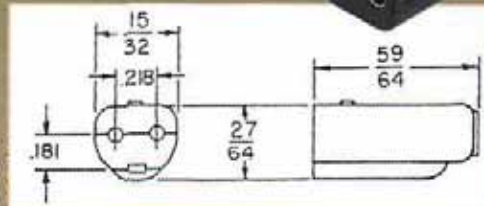

Microphone Locking Jack, Three Conductor
Mates with Nexus MP-103 microphone plug, three conductor. Nickel plated beryllium copper contacts, spring actuated locking design iwth manual button release, assemble into nylon body.

MJ-113

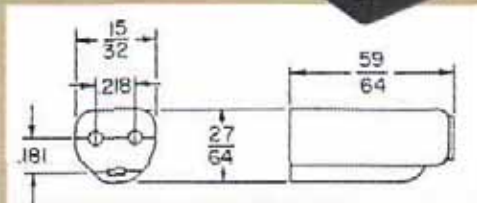

Microphone Jack, Three Conductor
Mates with Nexus MP-103 microphone plug, three conductor. Same as MJ-103 but without locking contacts. Nickel plated beryllium contacts assemble into nylon body.

MJ-123

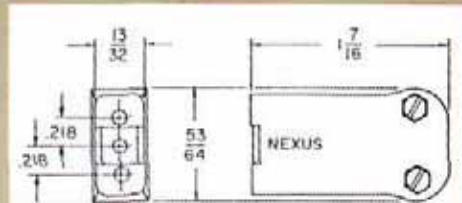

Three Conductor Jack
Special three conductor jack, nickel plated contacts assemble into nylon body.

MJS-103

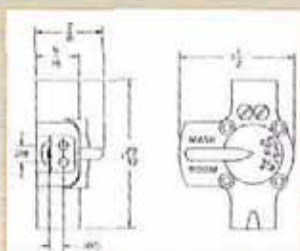

Microphone Jack Switch
Functions as a selector switch to choose either a boom microphone or a gasmask microphone by use of the switch lever. Mating connectors are two Nexus MP-103 plugs and one MJ-103 locking jack. This switch will also function with Nexus MP-102 and MJ-102 if the third circuit is not required.

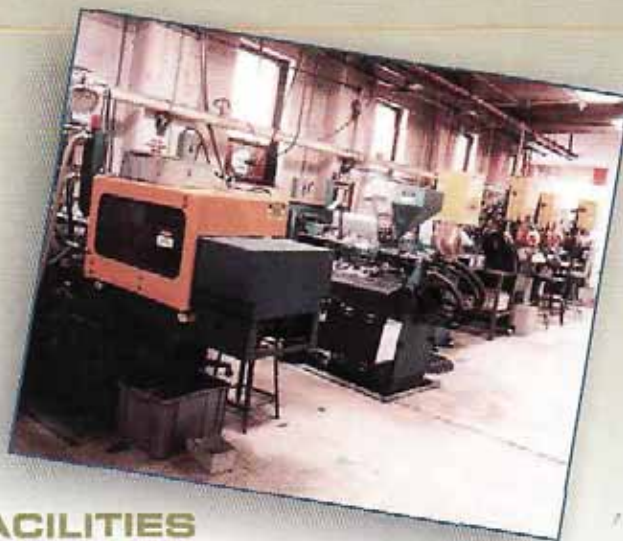

**FACILITIES
LOCATED IN
STAMFORD, CONNECTICUT,
USA**

**Amphenol®
NEXUS®
Technologies**

AP-107

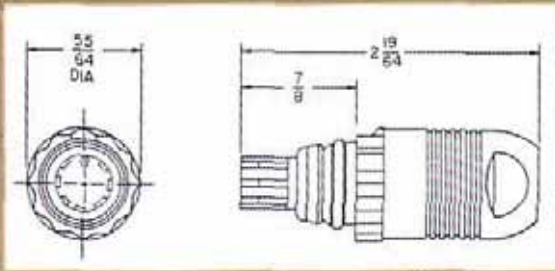

Seven Conductor, Watertight Breakaway Plug
 Mates with Nexus AJ-107 jack. A field replaceable connector designed to function in extremely severe environments.

AJ-107

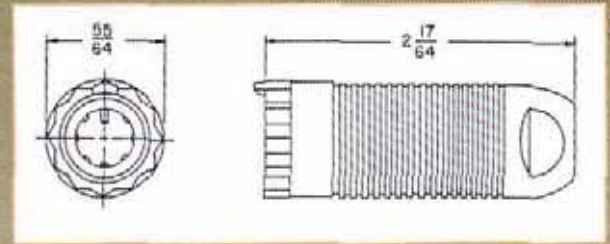

Seven Conductor, Watertight Breakaway Jack
 Mates with Nexus AP-107 plug. Designed to meet severe environmental conditions. This connector is field replaceable.

HARNESS DATA

NEXUS PART NUMBER	CABLE HOLDER		CABLE SEAL	CABLE (6 CONDUCTOR) WITH SHIELD
	PART NUMBER	FIGURE BELOW		
AP-107XL AJ-107XL	AP-107-3BXL AJ-107-3GXL	A	AP-107-27	.275 D/A .233 MIL-C-3885
AP-107XLS AJ-107XLS	AP-107-3BXLS AJ-107-3BXLS	B	AP-107-27	 MIL-C-3885
AP-107 AJ-107	AP-107-3B AJ-107-3G	C	CUSTOMER MOLDS STRAIN RELIEF, THEN USES AP-107-27	.172 D/A .158 MIL-C-55668
AP-107A AJ-107A	AP-107-3B AJ-107-3G	C	AP-107-31	

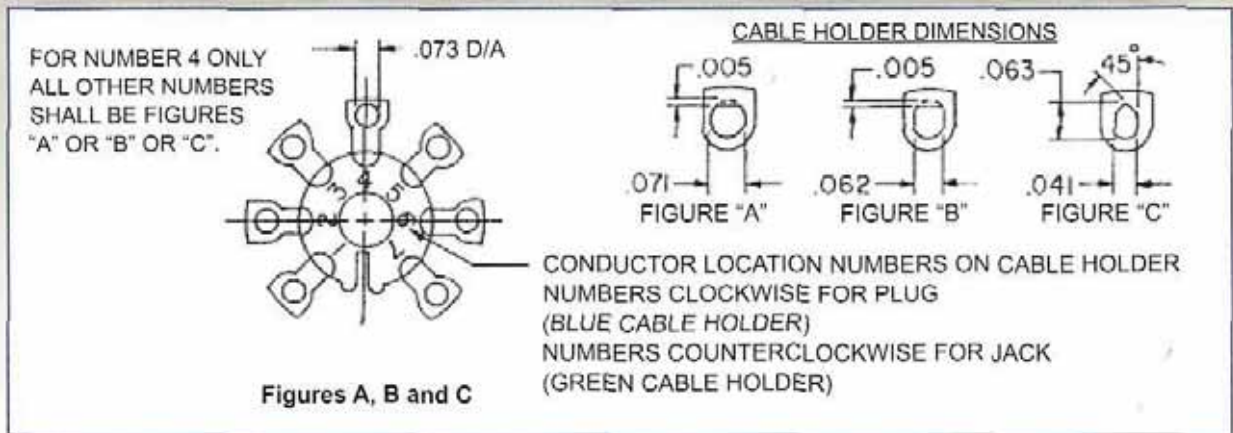

AP-107DR

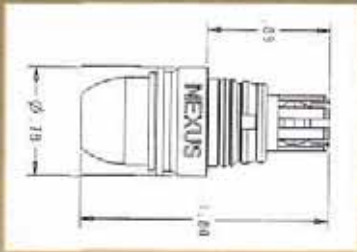

Over-moldable, Seven Conductor, Waterproof Plug

Mates with Nexus AJ-107DR jack. Snap on cap and insulation piercing terminals.

AJ-107DR



Over-moldable, Seven Conductor, Waterproof Jack

Mates with Nexus AP-107DR plug. Snap on cap and insulation piercing terminals.

AP-107DRS

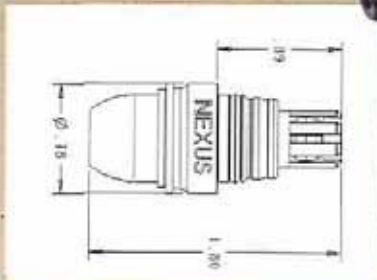

Over-moldable, Seven Conductor, Shielded Waterproof Plug

Mates with Nexus AJ-107DRS jack. Patented shielding back shell design. Snap on cap and insulation piercing terminals.

AJ-107DRS

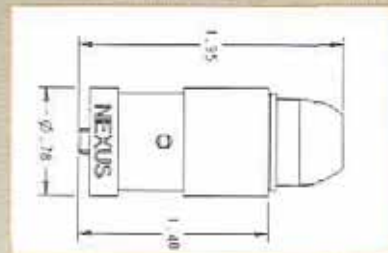

Over-moldable, Seven Conductor, Shielded Watertight Breakaway Jack

Mates with Nexus AP-107DRS plug. Patented shielding back shell design. Snap on cap and insulation piercing terminals.

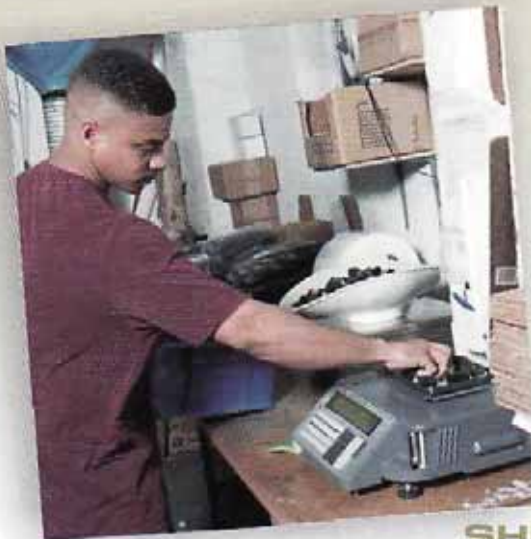

SHIPPING
DEPARTMENT

Amphenol®
NEXUS®
Technologies

Tel: 203-327-7300

Fax: 203-324-7623

www.nexus.com

email: salesinfo@nexus.com

AP-107BR

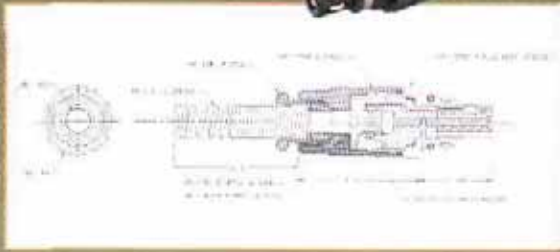

Seven Conductor, Waterproof Plug
Mates with Nexus AJ-107BR jack. Wire strain relief and solder terminals.

AJ-107BR

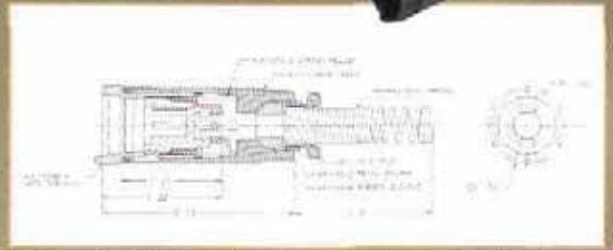

Seven Conductor, Waterproof Jack
Mates with Nexus AP-107BR plug. Wire strain relief and solder terminals.

AP-107BRS

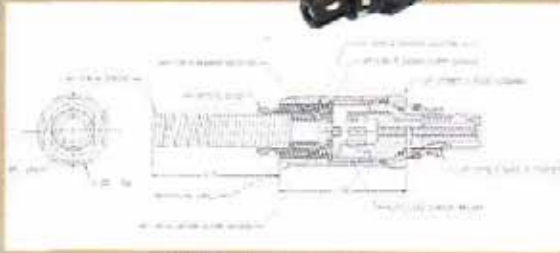

Seven Conductor, Shielded Waterproof Plug
Mates with Nexus AJ-107BRS jack. Wire strain relief and solder terminals. Termination method is similar to the AP-136.

AJ-107BRS

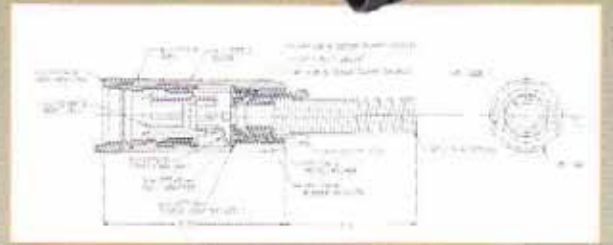

Seven Conductor, Shielded Waterproof Jack
Mates with Nexus AP-107BRS plug. Wire strain relief and solder terminals. Termination method is similar to the AP-136.

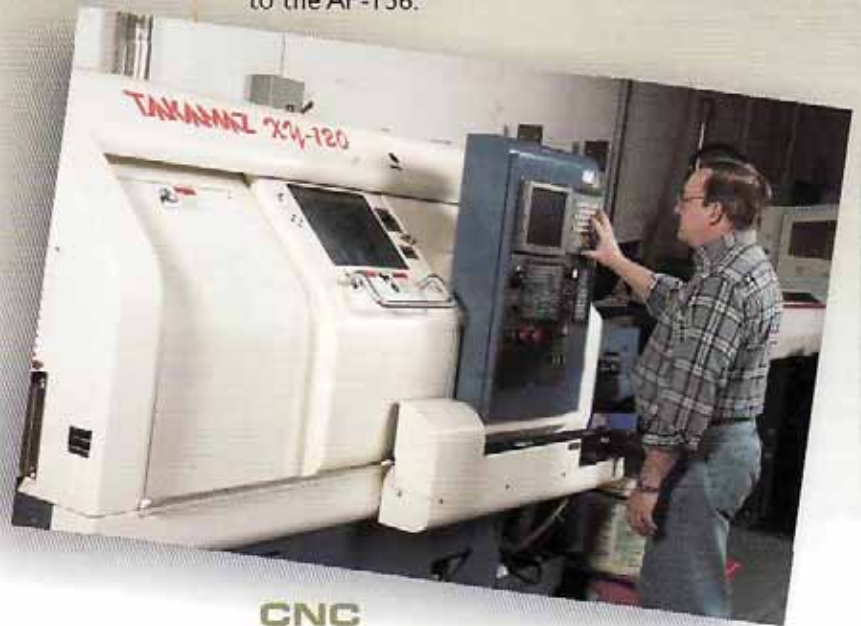

CNC
MACHINING

Amphenol®
NEXUS®
Technologies

AP-1170M

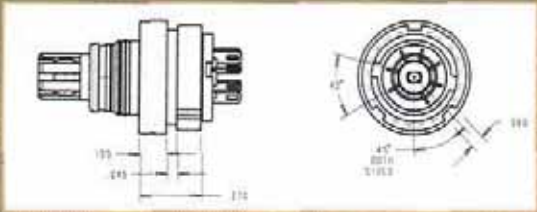

Seven Conductor, Miniature Waterproof Plug
Over mold version, solder terminals, mates with all versions of the AJ-117.

AJ-1170M

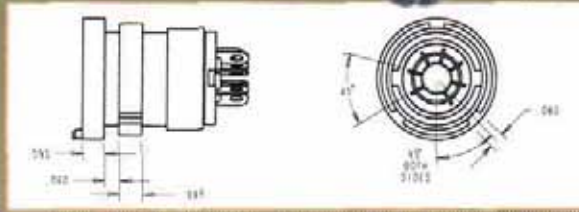

Seven Conductor, Miniature Waterproof Jack
Over mold version, solder terminals, mates with all versions of the AP-117.

AP-117BR

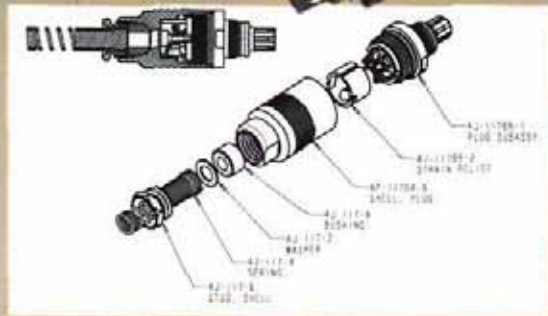

Seven Conductor, Miniature Waterproof Plug
Wire strain relief and solder terminals, .148" max cable diameter, mates with all versions of the AJ-117.

AJ-117BR

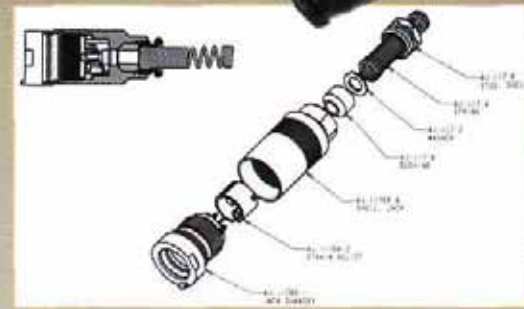

Seven Conductor, Miniature Waterproof Jack
Wire strain relief and solder terminals, .148" max cable diameter, mates with all versions of the AP-117.

AP-117BRXL

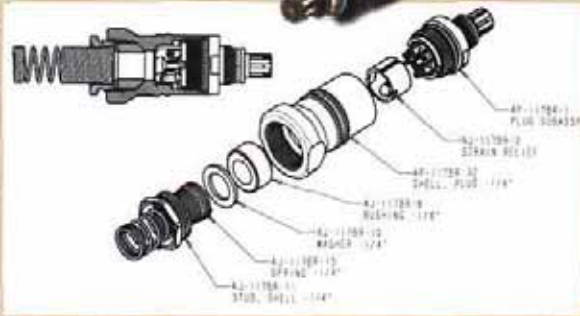

Seven Conductor, Miniature Waterproof Plug
Wire strain relief and solder terminals, .250" max cable diameter, mates with all versions of the AJ-117.

AJ-117BRXL



Seven Conductor, Miniature Waterproof Jack
Wire strain relief and solder terminals, .250" max cable diameter, mates with all versions of the AP-117.

Amphenol®
NEXUS
Technologies

AP-117LR-AL

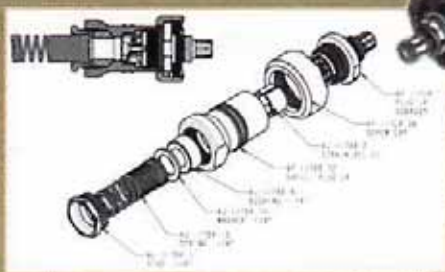

Seven Conductor, Miniature Waterproof Plug
 With locking ring, wire strain relief and solder terminals, .250" max cable diameter, mates with AJ-117LR-AL.

AJ-117LR-AL

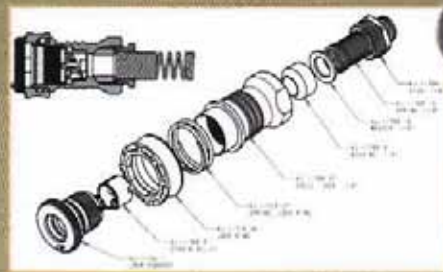

Seven Conductor, Miniature Waterproof Jack
 With locking ring, wire strain relief and solder terminals, .250" max cable diameter, mates with AP-117LR-AL.

AP-117PLR

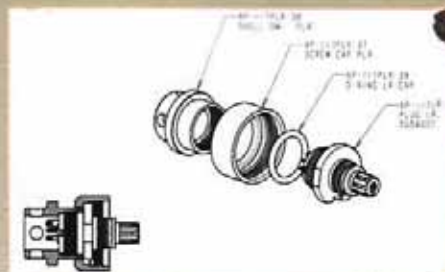

Seven Conductor, Miniature Waterproof Plug
 Over mold plug with locking ring, solder terminals, mates with AJ-117PLR.

AJ-117PLR

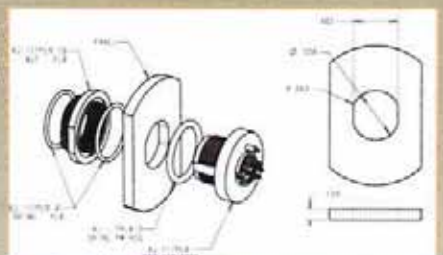

Seven Conductor, Miniature Waterproof Jack
 Rear mount panel mount with locking ring, solder terminals, mates with AP-117PLR.

AJ-117PM

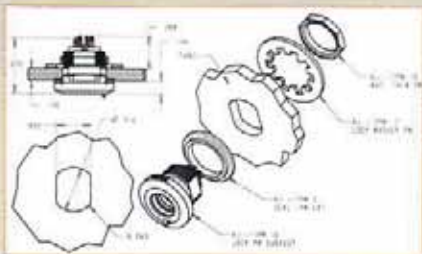

Seven Conductor, Miniature Waterproof Jack
 Front mount panel mount solder terminals, mates with all versions of the AP-117. Nut and lockwasher are included.

AJ-117PMDC



Seven Conductor, Miniature Waterproof Jack
 Rear mount panel mount solder terminals, mates with all versions of the AP-117.

Amphenol[®]
NEXUS[®]
 Technologies

AP-1100M

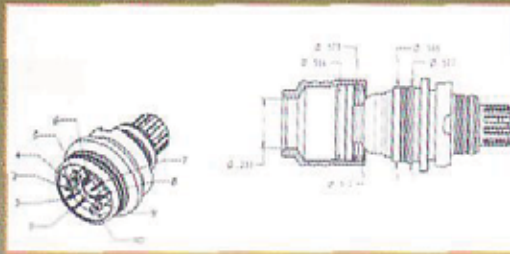

Ten Conductor, Miniature Waterproof Plug
Over mold version, solder terminals, mates with AJ-1100M.

AJ-1100M

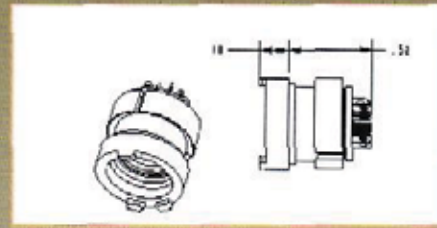

Ten Conductor, Miniature Waterproof Jack
Over mold version, solder terminals, mates AP-1100M.

AP-1100MS

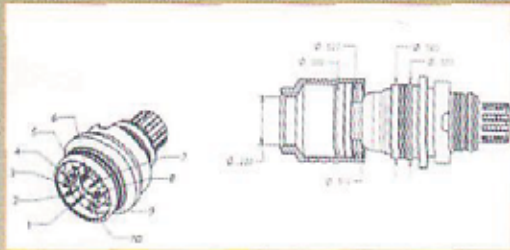

Ten Conductor, Miniature Waterproof Plug
Shielded version of AP-1100M. Mates with AJ-1100MS.

AJ-1100MS

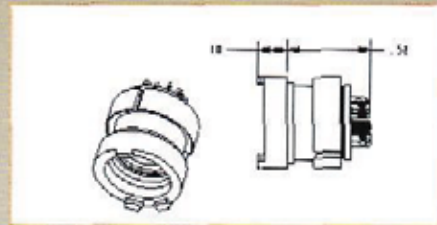

Ten Conductor, Miniature Waterproof Jack
Shielded version of AJ-1100M. Mates with AP-1100MS.



ASSEMBLY



**IN-HOUSE
CNC MACHINING**

Amphenol®
NEXUS
Technologies

Tel: 203-327-7300

Fax: 203-324-7623

www.nexus.com

email: salesinfo@nexus.com

MS-105

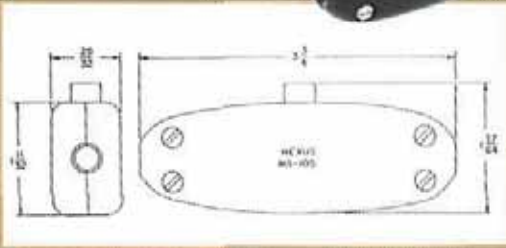

In-Line Multi-Purpose Switch

An in-line push button switch that is adaptable to a number of arrangements.

SS-401
(7064938)

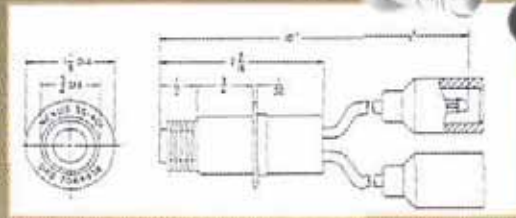

Push-Button Bellows Switch, Watertight

Used in areas requiring a watertight push-button switch exposed to extreme environmental conditions. Approved by U.S. Army Tank-Automotive Material Readiness Command.

MS-105CC

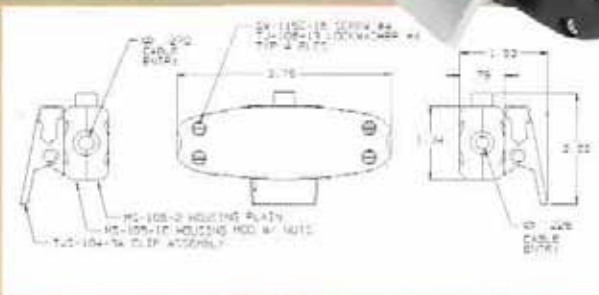

In-Line Multi-Purpose Switch with Clip

An in-line push button switch that is adaptable to a number of arrangements.



PROBLEM SOLVERS.

TJ-101PM

PROBLEM: The customer was looking for a panel mount 4-conductor jack that was sealed in the back. This seal will prevent water from leaking into the box.
SOLUTION: Utilizing a NEXUS in-line jack and a specially designed housing, we were able to solve the problem and provide a sample to their factory within one week.

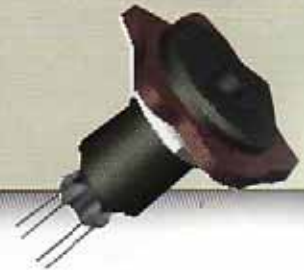

Amphenol®
NEXUS®
 Technologies

SPECIFICATIONS

AC Rating: 10 amps at 115 vac (Resistive load)
5 amps at 115 vac (Inductive load)
3 amps at 115 vac (Lamp load)

DC Rating: 10 amps at 28 vdc (Resistive load)
5 amps at 28 vdc (Inductive load)
3 amps at 28 vdc (Lamp load)

Type 7 Contact Arrangement: Ratings are one half amperage

Mechanical Life: 500,000 cycles

Action: Momentary snap or push-pull (as specified)

Plunger Travel: .085 inch (approx.)

Operating Force:
Ser. 20 & 30 3 to 5 pounds momentary
1/2 to 2 pounds push-pull
Ser. 22 & 32 2 to 3 pounds

Weight: 050 pound maximum

Case: Aluminum alloy, 2001 - T3, anodized in accordance with MIL-A-8625

Plunger: Glass filled nylon

Body: Diallyl phthalate in accordance with MIL-M-14

Terminals: Threaded 2-56 NC-2B

Terminal Hardware: Solder-type wire terminals, with terminal mounting screws and lockwashers, supplied with each switch

Mounting: Basic switch supplied with 1/2-32 UN-2B nut and internal tooth lockwasher. Switch with mounting adapter C, F, G or H supplied with 5/8-24 UNEF-2B nut and internal tooth lockwasher.

Special: Additional types of mounting, button styles, colors, and other variations are available on special order.

CONTACT ARRANGEMENTS BUTTON STYLES	(1) SPNO SINGLE POLE NORMALLY OPEN	(2) SPNC SINGLE POLE NORMALLY CLOSED	(3) Z-CIRCUIT CAN BE JUMPERED FOR SPDT	(4) 3-TERMINAL SINGLE POLE NORMALLY OPEN	(5) 3-TERMINAL SINGLE POLE NORMALLY CLOSED	(6) SPDT SINGLE POLE DOUBLE THROW	(7) DPST-NO DOUBLE POLE SINGLE THROW NORMALLY OPEN																				
	<p>1. SWITCHES WITHOUT ADAPTERS — The button height dimension shown for both Series 300 switches is taken from top of rubber boot to top of button. Button numbers 1, 3 (push-pull), and 5 is for the Series 300 dustproof switches. The only button available for Series 200 switches is the Number 2. The button height dimension shown is taken from the top of the housing to the top of the button.</p> <table border="1" style="width: 100%; border-collapse: collapse; text-align: center;"> <tr> <td style="width: 15%;">Switches Without Adapters (See Note 1)</td> <td></td> <td></td> <td></td> <td></td> <td>With Adapter</td> <td>With Adapter No. 8</td> </tr> <tr> <td></td> <td>No. 1</td> <td>No. 2</td> <td>No. 3</td> <td>No. 5</td> <td>No. 6</td> <td></td> </tr> <tr> <td>Switches With Adapters (See Note 2)</td> <td></td> <td></td> <td></td> <td></td> <td></td> <td></td> </tr> </table>							Switches Without Adapters (See Note 1)					With Adapter	With Adapter No. 8		No. 1	No. 2	No. 3	No. 5	No. 6		Switches With Adapters (See Note 2)					
Switches Without Adapters (See Note 1)					With Adapter	With Adapter No. 8																					
	No. 1	No. 2	No. 3	No. 5	No. 6																						
Switches With Adapters (See Note 2)																											
<p>2. SWITCHES WITH ADAPTERS — The button height dimension shown for both series of switches is taken from top of adapter to top of button. Button numbers 1, 3 (push-pull), and 5 is for the Series 300 dustproof switches. Buttons 2, 6 and 8 are for the Series 200 standard switches.</p>																											

Amphenol[®]
NEXUS[®]
Technologies

How To Order

SWITCH SERIES

- 20 - Standard momentary or push-pull switches
- 22 - Standard switches with 2-pound operating force
- 30 - Dustproof momentary or push-pull switches
- 32 - Dustproof switches with 2-pound operating force

ADAPTER TYPE

- O - Basic switch (no adapter)
- A - Switch with MIL type A adapter
- B - Switch with MIL type B adapter
- C - Switch with MIL type C adapter
- E - Switch with MIL type E adapter
- F - Switch with MIL type F adapter
- G - Switch with MIL type G adapter
- H - Switch with MIL type H adapter

ADAPTER COLOR

- B - Standard color, black
- R - Red
- C - Clear metal (aluminum)
- O - Without adapter

CONTACT ARRANGEMENTS

- 1 - SPN Single pole, normally open
- 2 - SPNC Single pole, normally closed
- 3 - 2-CIR Two circuit
- 4 - 3-TNO Three terminal, normally open
- 5 - 3-TNCT Three terminal, normally closed
- 6 - SPDT Single pole, double throw
- 7 - DPSTD Double pole, single throw, normally open

BUTTON STYLE

Numbers 1 through 8, see Button Styles on page 16.

BUTTON COLOR

- B - Standard color, black
- R - Red
- G - Gray
- W - White

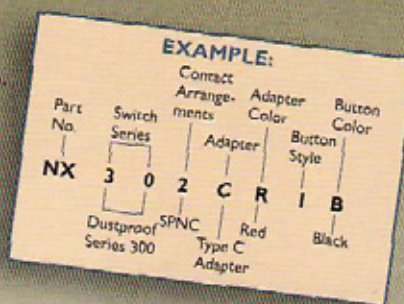

For switches with configurations and characteristics covered by MILS-S-8805/3, use the following table to convert from MIL to NEXUS part numbers. Order the NEXUS switch number shown in BOLD FACE below the MS25089 number. For white buttons, substitute W for B in the NEXUS part number.

CONVERSION TABLE - MIL-S-8805/3 TYPE NUMBERS AND NEXUS EQUIVALENTS

MOUNTING	SWITCH ACTION	BUTTON COLOR	CONTACT 1	CONTACT 2	CONTACT 3	CONTACT 4	CONTACT 5
A	MOMENTARY	Black	MS25089-1A NX301AB1B	MS25089-2A NX302AB1B	MS25089-3A NX303AB1B	MS25089-4A NX304AB1B	MS25089-5A NX305AB1B
		Red	MS25089-1AR NX301AR1R	MS25089-2AR NX302AR1R	MS25089-3AR NX303AR1R	MS25089-4AR NX304AR1R	MS25089-5AR NX305AR1R
B	MOMENTARY	Black	MS25089-1B NX301BB1B	MS25089-2B NX302BB1B	MS25089-3B NX303BB1B	MS25089-4B NX304BB1B	MS25089-5B NX305BB1B
		Red	MS25089-1BR NX301BB1R	MS25089-2BR NX302BB1R	MS25089-3BR NX303BB1R	MS25089-4BR NX304BB1R	MS25089-5BR NX305BB1R
C	MOMENTARY	Black	MS25089-1C NX301CB1B	MS25089-2C NX302CB1B	MS25089-3C NX303CB1B	MS25089-4C NX304CB1B	MS25089-5C NX305CB1B
		Red	MS25089-1CR NX301CB1R	MS25089-2CR NX302CB1R	MS25089-3CR NX303CB1R	MS25089-4CR NX304CB1R	MS25089-5CR NX305CB1R
	PUSH-PULL	Black	MS25089-1C-1 NX301CB3B	MS25089-2C-1 NX302CB3B	MS25089-3C-1 NX303CB3B		
		Red	MS25089-1CR-1 NX301CB3R	MS25089-2CR-1 NX302CB3R	MS25089-3CR-1 NX303CB3R		
E	MOMENTARY	Black	MS25089-1E NX301EB1B	MS25089-2E NX302EB1B	MS25089-3E NX303EB1B	MS25089-4E NX304EB1B	MS25089-5E NX305EB1B
		Red	MS25089-1ER NX301EB1R	MS25089-2ER NX302EB1R	MS25089-3ER NX303EB1R	MS25089-4ER NX304EB1R	MS25089-5ER NX305EB1R
F	MOMENTARY	Black	MS25089-1F NX301FB1B	MS25089-2F NX302FB1B	MS25089-3F NX303FB1B	MS25089-4F NX304FB1B	MS25089-5F NX305FB1B
		Red	MS25089-1FR NX301FB1R	MS25089-2FR NX302FB1R	MS25089-3FR NX303FB1R	MS25089-4FR NX304FB1R	MS25089-5FR NX305FB1R
	PUSH-PULL	Black	MS25089-1F-1 NX301FB3B	MS25089-2F-1 NX302FB3B	MS25089-3F-1 NX303FB3B		
		Red	MS25089-1FR-1 NX301FB3R	MS25089-2FR-1 NX302FB3R	MS25089-3FR-1 NX303FB3R		
G	MOMENTARY	Black	MS25089-1G NX301GB1B	MS25089-2G NX302GB1B	MS25089-3G NX303GB1B	MS25089-4G NX304GB1B	MS25089-5G NX305GB1B
		Red	MS25089-1GR NX301GB1R	MS25089-2GR NX302GB1R	MS25089-3GR NX303GB1R	MS25089-4GR NX304GB1R	MS25089-5GR NX305GB1R
	PUSH-PULL	Black	MS25089-1G-1 NX301GB3B	MS25089-2G-1 NX302GB3B	MS25089-3G-1 NX303GB3B		
		Red	MS25089-1GR-1 NX301GB3R	MS25089-2GR-1 NX302GB3R	MS25089-3GR-1 NX303GB3R		
H	MOMENTARY	Black	MS25089-1H NX301HB1B	MS25089-2H NX302HB1B	MS25089-3H NX303HB1B	MS25089-4H NX304HB1B	MS25089-5H NX305HB1B
		Red	MS25089-1HR NX301HB1R	MS25089-2HR NX302HB1R	MS25089-3HR NX303HB1R	MS25089-4HR NX304HB1R	MS25089-5HR NX305HB1R
	PUSH-PULL	Black	MS25089-1H-1 NX301HB3B	MS25089-2H-1 NX302HB3B	MS25089-3H-1 NX303HB3B		
		Red	MS25089-1HR-1 NX301HB3R	MS25089-2HR-1 NX302HB3R	MS25089-3HR-1 NX303HB3R		

Amphenol®
NEXUS®
Technologies

Amphenol Nexus
50 Sunnyside Avenue
P.O. Box 10177
Stamford, CT 06904-2177
Phone: 203-327-7300
Fax: 203-324-7623
E-mail: salesinfo@nexus.com
Web: www.nexus.com

Amphenol Corporation
Amphenol Aerospace
Amphenol Industrial
Amphenol Commercial Air
40-60 Delaware Avenue,
Sidney, NY 13898-1395
Phone: 607-563-5011 1-800-678-0141
Fax: 607-563-5157
www.amphenol-aerospace.com
www.amphenol-industrial.com

Amphenol Corporation
Amphenol Aerospace
2010 Corporate Ridge
Mid.lean, VA 22101
Phone: 1-800-878-0141

OTHER AMPHENOL DIVISIONS
Amphenol Backplane Systems
18 Cellina Avenue
Nashua, NH 03063
Phone: 888-318-3553
Fax: 603-883-0171
Web: www.amphenol.abs.com

Amphenol Canada
605 Milner Ave.
Toronto, Ontario M1B 5X6
Phone: 416-291-4401
Fax: 416-292-0647
Web: www.amphenolcanada.com

Amphenol PCD
72 Cherry Hill Drive
Beverly, MA 01915
Phone: 978-824-3400
Fax: 978-927-1513
Web: www.amphenolpcd.com
E-mail: mllaero@amphenolpcd.com

Amphenol Printed Circuits
91 Northeastern Boulevard
Nashua, NH 03062
Phone: 603-324-4500
Fax: 603-324-4717
Web: www.amphenol-lcs.com

SV Microwave
RF Connectors & Components,
an Amphenol Company
2400 Centrepark West Drive,
Suite 100
West Palm Beach, FL 33409
Phone: 561-840-1800
Fax: 561-844-8551
E-mail: sales@svmicro.com
Web: www.svmicrowave.com

DISTRIBUTORS
Corporate Headquarters
Alphabetical Listing

ARROW ELECTRONICS
7459 S. Lima Street
Englewood, CO 80112-5816
Phone: 800-833-3557
Fax: 800-562-3642
Web: www.arrow.com

AVNET
2211 47th Street
Phoenix, AZ 85034
Phone: 800-332-8638
Web: www.avnet.com

TTI INC.
2441 Northeast Pkwy.
Fort Worth, TX 76106
Phone: 800-225-5884
Fax: 817-740-9494
Web: www.ttiinc.com

INTERNATIONAL DISTRIBUTOR
PAMBRY ELECTRONICS LTD.
Pambry House
Units 7 & 8
Ventura Centre
Ventura Place
Upton Industrial Estate
Upton, Poole
Dorset BH16 5SW, United Kingdom
Phone: +44 (0)1202 624910
Fax: +44 (0)1202 632452
Email: sales@pambry.co.uk

Europe
ENGLAND
Amphenol Limited
Thanet Way, Whitstable
Kent CT5 3JF, United Kingdom
Phone: (44-1-227) 773200
Fax: (44-1-227) 276571
E-mail: info@amphenol.co.uk

INTERNATIONAL
Latin America
ARGENTINA
Amphenol Argentina
Avenida Callao 930
2nd floor Office B Plaza
C1023AAP Buenos Aires, Argentina
Phone: (54 11) 48 15 68 86
Fax: (54 11) 48 14 57 79
E-mail: www.@amphenol.com.ar

BRAZIL
Amphenol do Brasil Ltda.
Rua Diogo Moreira 132
20 Ander, Rooms 2001-2-3
CEP 05423-010
Sao Paulo - SP, Brazil
Phone: (55-11) 3815.1003
Fax: (55-11) 3815.1629
E-mail: vendas@amphenol.com.br

MEXICO
Amphenol Mexico
Prolongacion Reforma 61-6 B2
Col. Paseo de las Lomas
C.P. 01330 Mexico D.F., Mexico
Phone: (52-55) 5258.9984
Fax: (52-55) 5081.6890
E-mail: www.@amphenolmexico.com

FRANCE
Amphenol Socapex
Promenade de l'Arve, Bp29
Thyez 74311 948 Cedex, France
Phone: (33-4) 50892800
Fax: (33-4) 50862975
Web: www.amphenol-socapex.com

FRANCE
Amphenol-Air LB
29, Voie d'Y Vois
F-08110 Blagny, France
Phone: (33-3) 2422-7849
Fax: (33-3) 2422-1319
Web: www.amphenol-airlb.fr

GERMANY
Amphenol-Air LB GmbH
Am Kleinbahnhof 4
D-66740 SaarLouis, Germany
Phone: (49-6831) 981-00
Fax: (49-6831) 9810-30
Web: www.amphenol-airlb.com

ITALY & REST OF EUROPE
Amphenol Italia S.p.A.
Via Barbaiana 5
20020 Lainate (Milano), Italy
Phone: 39-02-932541
Fax: 39-02-9325444
E-mail: info@amphenol-it.com

Middle East / Africa
ISRAEL
Bar-Tec Ltd.
3 Hagavish St., P.O.B. 279
Kfir-Barkan Bldg., East Industrial Zone
Kfar Sava 44102, Israel
Phone: (972-9) 764.4100
Fax: (972-9) 7674324
E-mail: sales@bar-tec.com
Web: www.bar-tec.com

SOUTH AFRICA
Amphenol South Africa
30 Impala Road
2196 Sandton - Chislehurst
South Africa
Phone: (27-11) 783-9517
Fax: (27-11) 783-9519
E-mail: amphenol_africa@osi.com
Web: www.amphenol.co.za

TURKEY
Amphenol Turkiye
Ayazaga Meh. Meydan Sk. No. 28
Beybi Giz Plaza, Kat. 263496
Maslak/Istanbul
Phone: 90 (212) 335 25 01
Fax: 990 (212) 335 25 00
E-mail: saracoglu@amphenol.com.tr
Web: www.amphenol.com.tr

Asia / Pacific
AUSTRALIA
Amphenol Australia LTD
2 Flveways Blvd, Keysborough
Melbourne, Victoria 3173 Australia
Phone: 613 8796 8888
Fax: 613 8796 8801
E-mail: www.@amphenol.com.au

RUSSIA
Amphenol Russia Office
8 Yaroslavskaja Str.
Floor 2129164 Moscow, Russia
Phone: 7495 937 6341
Fax: 7495 937 6319
E-mail: russia@amphenol.com

INDIA
Amphenol Interconnect India Pvt. Ltd.
105 Bhosari Industrial Area
Pune, 411 026, India
Phone: (91-20) 27120 462
Fax: (91-20) 27129 158
E-mail: sales@amphenol-in.com

JAPAN
Amphenol Japan Mill/Aero & Industrial
471-1, Deba, Ritto-city
Shiga 520-3041, Japan
Phone: 81-77-553-8501
Fax: 81-77-551-2200

Notice: Specifications are subject to change without notice. Contact your nearest Amphenol Corporation Sales Office for the latest specifications. All statements, information and data given herein are believed to be accurate and reliable but are presented without guarantee, warranty, or responsibility of any kind expressed or implied. Statements or suggestions concerning possible use of our products are made without representation or warranty that any such use is free of patent infringement and are not recommendations to infringe any patent. The user should not assume that all safety measures are indicated or that other measures may not be required. Specifications are typical and may not apply to all connectors.

Amphenol[®]
NEXUS[®]
Technologies

Tel: 203-327-7300 Fax: 203-324-7623 www.nexus.com email: salesinfo@nexus.com

PROBLEM SOLVER.



That's how our customers think of us . . . as their exclusive *Problem Solver*. With our prompt customer response, the Amphenol Nexus Technologies team can redesign your old product to meet your current custom needs.

Customer Support Team.

Most quotes are turned around the same day allowing you the opportunity to submit your budgets on time.

Design Consulting Team.

With in-house 3-D design capabilities, solutions can be on your desk in three days.

Engineering Team.

Our CNC machining, tooling, stamping, molding and kitting capabilities support our engineering expertise and allows delivery of prototypes promptly.

Quality Assurance Team.

We make sure that the materials requested meet the product's environmental specifications for reliability and endurance whether your product utilizes domestic or international compliance.

We are available to meet with your staff and bring our consulting capabilities right to your facility. Building on our strength of decades of engineering experience, our team can solve technical problems by designing around your specific needs.

Our role as *Problem Solvers* is based on our strong commitment to reliability and teamwork. We are proud to state that all of our products are 100% American made.



Amphenol[®]
NEXUS[®]
Technologies

www.nexus.com

Proudly
Made in U.S.A.



**STRONG
COMMITMENT
TO RELIABILITY
& TEAMWORK.**



**Amphenol[®]
NEXUS[®]
Technologies**

Telephone: 203-327-7300 Fax: 203-324-7623 Email: salesinfo@nexus.com
www.nexus.com

50 Sunnyside Avenue
P.O. Box 10177
Stamford, Connecticut 06904-2177, USA

X-ON Electronics

Largest Supplier of Electrical and Electronic Components

Click to view similar products for [Phone Connectors](#) category:

Click to view products by [Amphenol](#) manufacturer:

Other Similar products are found below :

[M444B](#) [6J1041A](#) [R4F](#) [E12BPKG](#) [ECP4PKG](#) [161-3502L-E](#) [MT333X](#) [171-0350-EX](#) [171-101A-EX](#) [171-3325-EX](#) [176S](#) [NC3MG-V](#)
[NYS228G](#) [P10834](#) [P2380](#) [P2381X](#) [P2411X](#) [P2412](#) [P2724](#) [JM2PB-AU BULK](#) [9144](#) [S2674](#) [280L](#) [163-156N-2-E](#) [163-158N-2-E](#) [171-3308-](#)
[EX](#) [171-3500-E](#) [2501FT](#) [CMT335](#) [M10662](#) [330Q](#) [RJ5VI-S](#) [40116](#) [TM1R-AU](#) [TM2PBMJ-AU](#) [TM2PJ-AU](#) [TM2PJ-AU BULK](#) [4803.1351](#)
[49201](#) [49205](#) [TS3PBJ-AU](#) [TS3PBMJ-AU](#) [TT32BX](#) [54B](#) [40112](#) [40205](#) [XMT332B](#) [52170017-331](#) [570](#) [NM3](#)