

NMEA 2000 Connector

Range Overview

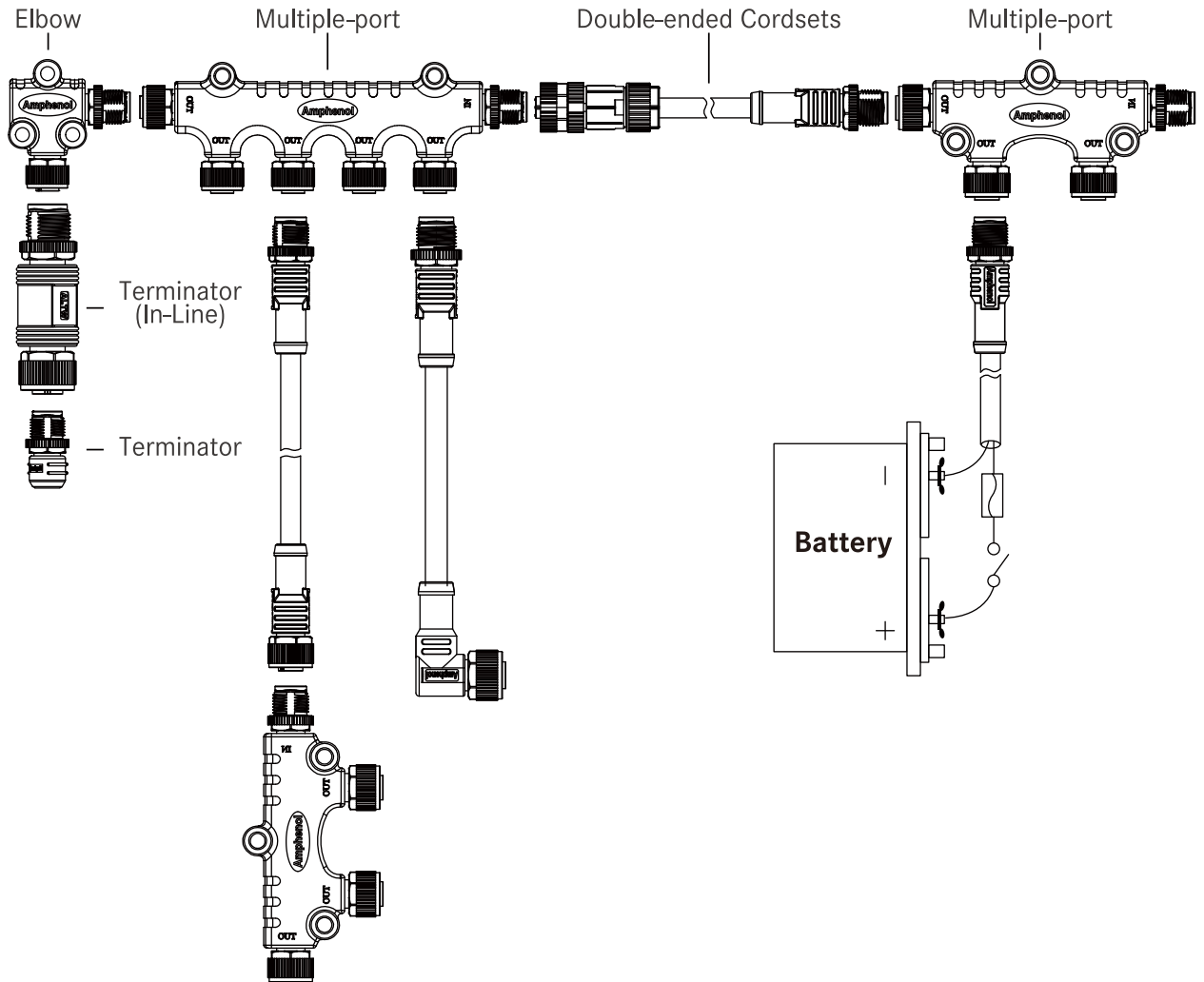

About NMEA 2000

Amphenol LTW Technology expands its coverage targeting the marine industry that features the NMEA 2000 standard.

The NMEA 2000 standard contains the requirements of a serial data communications network to inter-connect marine electronic equipment on

vessels. It is multi-master and self-configuring, and there is no central network controller. Equipment designed to this standard will have the ability to share data, including commands and status with other compatible equipment over a status with other compatible equipment over a single channel.

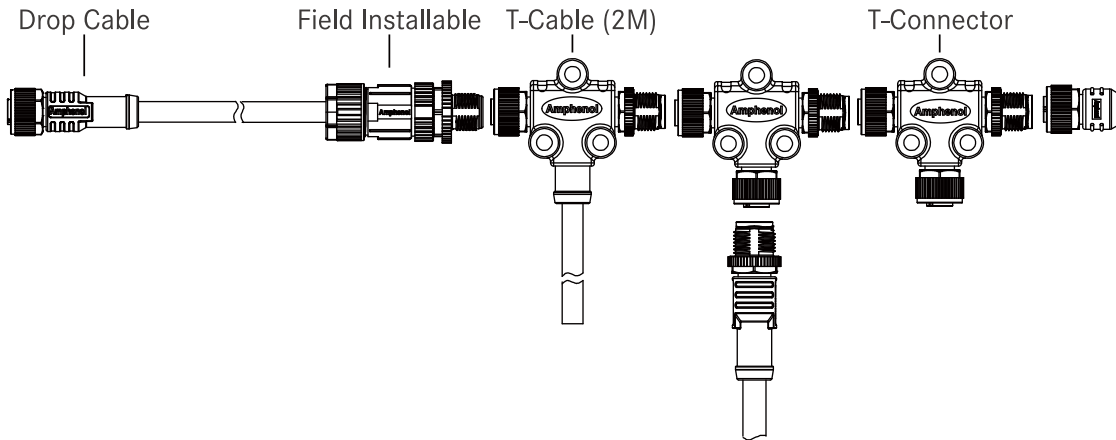

> Items (Mini to Micro)

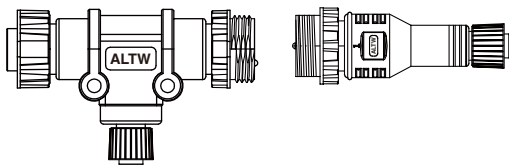

T-Adaptor
° P13-17

I-Adaptor
° P13-17

> Items for devices

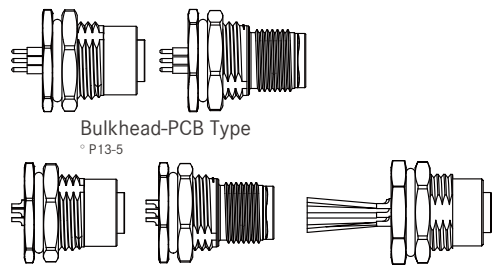

Bulkhead-PCB Type
° P13-5

Bulkhead-Solder Type
° P13-6

> Items for power source

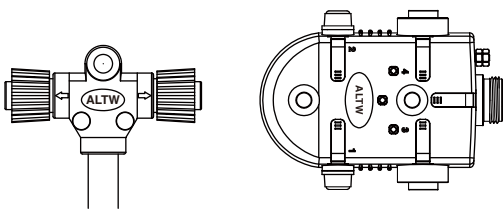

<Micro>
T-cable
° P13-11

<Mini>
Power Tap Tee
° P13-20

> More Selection

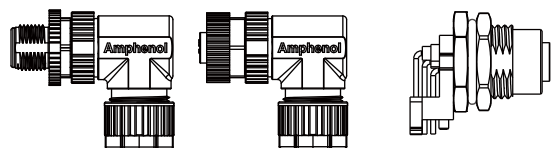

Field Installable
° P13-9

Bulkhead
(Right Angle)
° P13-7

[Note] Design and specification are subject to change without notice.

Specification

| | |
|------------------------------|--|
| Identifications | Micro (AWG: 22 AWG, 24 AWG) Mini (AWG: 18 AWG, 15AWG) |
| Description | <p>Micro: Bulkhead (With Wire / Double-ended / Right Angle) Cable (Drop Line / Double-ended Cordset / T-Cable) Field Installable Network Terminator (Single-ended / In-line) Adaptor (T-Adaptor / Elbow) Multi-port Waterproof Cap</p> <p>Mini: Bulkhead (Double-ended) Cable (Drop Line / Double-ended Cordset / T-Cable) Field Installable Network Terminator (Single-ended) Adaptor (T-Adaptor / Elbow) Power Tap Tee Waterproof Cap</p> <p>Mini to Micro: Adaptor (T-Adaptor / I-Adaptor)</p> |
| Current Rating / Data | Micro: 4A Mini: 8A |
| Material | Contacts: Copper Alloy, Gold Plated Contacts Holder: PA |
| Waterproof Rating | IP67~68 |
| Temperature Range | Receptacle: -40°C ~ 85°C Overmolded with Cable: -20°C ~ 80°C Field Installable: Nylon+GF: -40°C ~ 105°C PU: -20°C ~ 85°C * Higer working temperature upon request. |

Contact Configuration

| | Micro-C | Mini-C |
|------|----------|----------|
| | 4A | 8A |
| | FF or MM | FF or MM |
| 4Pin | | |
| 5Pin | | |

△ 4A
○ 8A

Number of Contacts:
e.g. 2 contacts (02)

Connector (Housing) Gender:
Male(M) or Female(F)

Contact Gender:
Male(M) or Female(F)

More to Choose:

- Solder (S)
- Solder Cup



- Screw In (B)



Cabling Information

Micro

NMEA Approved

(A): (24#* 1P+AL) + (22#* 1P+AL) + Drain + Mylar + Braid

(B): (16#* 1P+AL) + (20# * 1P+AL) +D +AL +Braid

Conforming

(A): (24#* 1P+AL) + (22#* 1P+AL) + Drain + AL + Braid

(B): (22#* 1P+AL) + (18#* 1P+AL) + Drain + AL + Braid

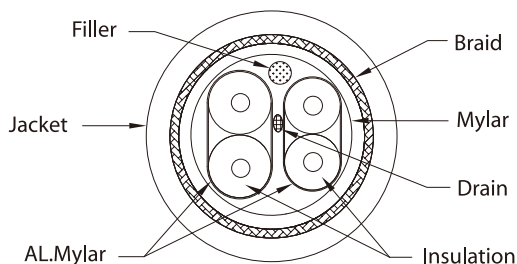

Mini

NMEA Approved

(C): (18#* 1P+AL) + (15#* 1P+AL) + Drain + Braid

Conforming

(C): (18#* 1P+AL) + (16#* 1P+AL) + Drain + AL+Braid

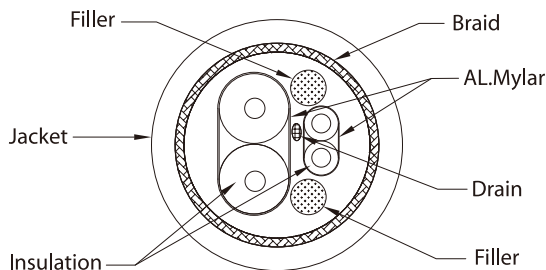

[Note] Design and specification are subject to change without notice.

Find Our Standard Products

Micro > Bulkhead (Double-ended)

| | | | |
|--|-----------|---|--|
| <ul style="list-style-type: none"> • 5 Contacts • Screw Thread • Unmated IP68 | | <p>18 (Hexagon) For Panel thickness Max 8.5mm</p> <p>Unit: mm</p> | |
| Type | Connector | Part Number (Female Connector / Female Contacts) | |
| Certified NMEA 2000 (4A, 60V) | | UMC-000505-0FM-BS001 | |
| None-Certified NMEA 2000 (4A, 60V) | | MC-000505-0FM-BS001 | |

Micro > Bulkhead (Straight) > PCB Type

| | | | |
|---|-----------|---|---|
| <ul style="list-style-type: none"> • 5 Contacts • Screw Thread • For Device Side • PCB Pin (180°) • Unmated IP68 | | <p>Metal</p> <p>Maximum Panel Thickness: 4.5mm</p> <p>OD: 15.4</p> <p>13.6</p> <p>Plastic</p> <p>Maximum Panel Thickness: 4.5mm</p> <p>OD: 15.4</p> <p>13.6</p> <p>Unit: mm</p> | <p>Metal</p> <p>Maximum Panel Thickness: 4.5mm</p> <p>OD: 15.4</p> <p>13.6</p> <p>Plastic</p> <p>Maximum Panel Thickness: 4.5mm</p> <p>OD: 15.4</p> <p>13.6</p> <p>Unit: mm</p> |
| Type | Connector | Part Number (Male Connector / Male Contacts) | Part Number (Female Connector / Female Contacts) |
| Certified NMEA 2000 (4A, 60V) | Metal | HMC-05PMMP-SF8001 | HMC-05PFFP-SF8001 |
| | Plastic | HPC-05PMMP-SF8001 | HPC-05PFFP-SF8001 |

Micro > Bulkhead (Straight) > Solder Type

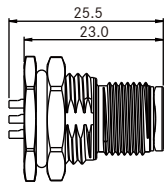
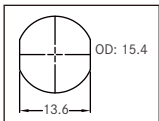
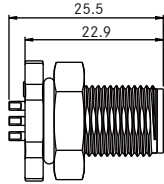
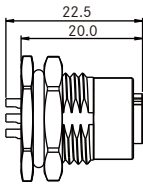
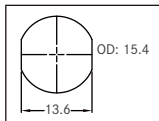
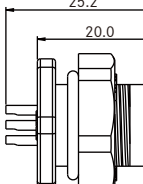
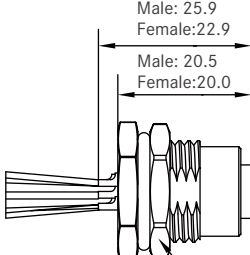
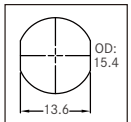
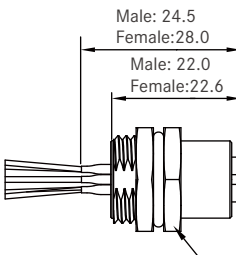
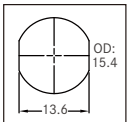
| | | | | | |
|--|----------------|--|--|--|--|
| <ul style="list-style-type: none"> • 5 Contacts • Screw Thread • For Device Side • Solder Pin (180°) • Unmated IP68 | | <p>Certified</p> <p>Metal</p>  <p>25.5 23.0</p> <p>Maximum Panel Thickness: 4.5mm</p>  <p>OD: 15.4 13.6</p> <p>Plastic</p>  <p>25.5 22.9</p> | | <p>Certified</p> <p>Metal</p>  <p>22.5 20.0</p> <p>Maximum Panel Thickness: 4.5mm</p>  <p>OD: 15.4 13.6</p> <p>Plastic</p>  <p>25.2 20.0</p> | |
| | | <p>None-Certified</p>  <p>Male: 25.9 Female: 22.9 Male: 20.5 Female: 20.0</p>  <p>OD: 15.4 13.6</p> <p>18 (Hexagon)</p> | | <p>None-Certified</p>  <p>Male: 24.5 Female: 28.0 Male: 22.0 Female: 22.6</p>  <p>OD: 15.4 13.6</p> <p>18 (Hexagon)</p> | |
| | | | | <p>Unit: mm</p> | |
| | | <p>Connector</p> | | <p>Part Number (Male Connector / Male Contacts)</p> | |
| <p>Certified NMEA 2000 (4A, 60V)</p> | <p>Metal</p> | <p>HMC-05PMMS-SF8001</p> | | <p>HMC-05PFFS-SF8001</p> | |
| | <p>Plastic</p> | <p>HPC-05PMMS-SF8001</p> | | <p>HPC-05PFFS-SF8001</p> | |
| <p>None-Certified NMEA 2000 (4A, 60V)</p> | <p>Metal</p> | <p>MC-05PMMS-S 8 8001</p> | | <p>MC-05PFFS-S 8 8001</p> | |

8 Front Fastened (F) or Rear Fastened (H)

[Note] Design and specification are subject to change without notice.

Micro > Bulkhead (Right Angle)

| <ul style="list-style-type: none"> • 5 Contacts • Screw Thread • For device side • Unmated IP68 / Mated IP67 | | <p>* IP 68 (Unmated)</p> <p>Male (29.5) Female (29.0) Male (20.5) Female (20.0)</p> | | <p>* IP 67 (Mated)</p> <p>Male (24.8) Female (25.5) Male (16.2) Female (16.9)</p> <p>Unit: mm</p> | |
|--|-----------|---|---|---|--|
| Type | Connector | Part Number (Male Connector / Male Contacts) | Part Number (Female Connector / Female Contacts) | | |
| None - Certified NMEA 2000 (4A, 60V) | Metal | 12-05PMMR-SF7001 | 12-05PMMR-SF7001 | | |
| | Plastic | 12P-05PMMR-SF8001 | 12P-05PMMR-SF8001 | | |

Micro > Cable > Drop Line

| <ul style="list-style-type: none"> • 5 Contacts • Screw Thread • For Power Tap Connection • Mated IP68 • Current Rating <ul style="list-style-type: none"> - Connector: 4A - Cable: 3A | | | | <p>Unit: mm</p> | |
|--|-----------|---|---|-----------------|--|
| Type | Connector | Part Number (Male Connector / Male Contacts) | Part Number (Female Connector / Female Contacts) | | |
| Certified NMEA 2000 (3A, 60V) | Metal | HMC-05BMMM-SL8A <u>XX</u> * | HMC-05BFFM-SL8A <u>XX</u> * | | |
| | Plastic | UMC-05BMMM-SL8A <u>XX</u> * | - | | |
| None - Certified NMEA 2000 (3A, 60V) | Metal | MC-05BMMM-SL8A <u>XX</u> * | MC-05BFFM-SL8A <u>XX</u> * | | |
| | | MC-05BMMM-SL8B <u>XX</u> * | MC-05BFFM-SL8B <u>XX</u> * | | |
| | Plastic | MCP-05BMMM-SL8A <u>XX</u> * | MCP-05BFFM-SL8A <u>XX</u> * | | |
| | | MCP-05BMMM-SL8B <u>XX</u> * | MCP-05BFFM-SL8B <u>XX</u> * | | |

*XX: Cable length available in 1M (01), 2M (02), 5M (05), 10M (10).

Micro > Power Cable

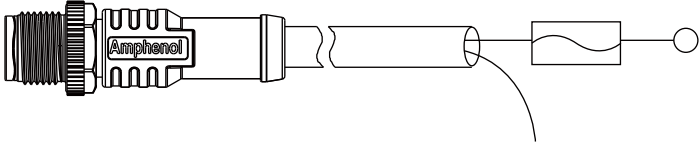
| | | | | | | | | |
|--|--|---|---|----------------------------------|--|-----------------------------|--|--|
| <ul style="list-style-type: none"> • 5 Contacts • Screw Thread • For Powering NMEA 2000 Network System • Mated IP68 • Current Rating <ul style="list-style-type: none"> - Connector: 4A - Cable: 3A (With 3A Fuse) |  | Unit: mm | | | | | | |
| <table border="1" style="width: 100%; border-collapse: collapse;"> <tr> <td style="width: 20%; text-align: center;">Type</td> <td style="text-align: center;">Connector</td> <td style="text-align: center;">Part Number (Male Connector / Male Contacts)</td> </tr> <tr> <td style="text-align: center;">Certified NMEA 2000 (3A, 60V)</td> <td></td> <td style="text-align: center;">HPC-05CMMM-SL8A<u>XX</u>*</td> </tr> </table> | Type | Connector | Part Number (Male Connector / Male Contacts) | Certified NMEA 2000 (3A, 60V) | | HPC-05CMMM-SL8A <u>XX</u> * | | |
| Type | Connector | Part Number (Male Connector / Male Contacts) | | | | | | |
| Certified NMEA 2000 (3A, 60V) | | HPC-05CMMM-SL8A <u>XX</u> * | | | | | | |

*XX: Cable length available in 1M (01), 2M (02), 5M (05), 10M (10).

Micro > Cable > Double-ended Cordset

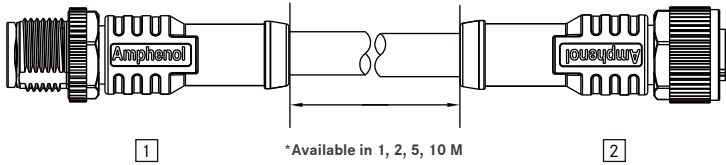
| | | |
|--|---|-----------------------------|
| <ul style="list-style-type: none"> • 5 contacts • Screw Thread • For Power Tap Connection • Mated IP68 • Current Rating <ul style="list-style-type: none"> - Connector: 4A - Cable: 3A |  | *Available in 1, 2, 5, 10 M |
| *Cable 22+24+B PVC | | |

| Connector | | End 1 | End 2 | End 1 | End 2 | End 1 | End 2 |
|---|---------|-----------------------------|-------|-----------------------------|-------|--------------------------------|-------|
| | | Type | | Type | | Type | |
| Type | | Male | | Female | | Male | |
| Type | | Male | | Female | | Female | |
| Certified NMEA 2000 (3A, 60V) | Metal | - | - | - | - | HMC-000505-0MF-CSA <u>XX</u> * | |
| | Plastic | - | - | - | - | UMC-000505-0MF-CS <u>XX</u> * | |
| None - Certified NMEA 2000 (3A, 60V) | Metal | MC-000505-0MM-C <u>XX</u> * | | MC-000505-0FF-C <u>XX</u> * | | MC-000505-0MF-CS <u>XX</u> * | |
| | Plastic | PC-000505-0MM-C <u>XX</u> * | | PC-000505-0FF-C <u>XX</u> * | | PC-000505-0MF-CS <u>XX</u> * | |

*XX: Cable length available in 1 (01), 2 (02), 5 (05), 10 (10)M.

[Note] Design and specification are subject to change without notice.

Micro > Power Cable (Double Ends)

| | | | |
|---|---------|-----------------------|--------|
| <ul style="list-style-type: none"> • 5 Contacts • Screw Thread • For Powering NMEA 2000 Network System • Mated IP68 • Current Rating <ul style="list-style-type: none"> - Connector: 4A - Cable: 3A | | | |
| Connector Type | | End 1 | End 2 |
| | | Male | Female |
| Certified NMEA 2000 (3A, 60V) | Plastic | HPC-000505-0MF-DSAXX* | |

*XX: Cable length available in 1 (01), 2 (02), 5 (05), 10 (10)M.

Micro > Field Installable (Right Angle)

| | | | |
|---|--|---|--|
| <ul style="list-style-type: none"> • 5 contacts • Screw Thread • Screw-in Contacts • Mated IP67 | | | |
| Connector Type | | Part Number (Male Connector / Male Contacts) | Part Number (Female Connector / Female Contacts) |
| | | Certified NMEA 2000 (4A, 60V) | Metal HMC-05BMMB-SR7001 (Ø4.5 ~Ø6.0mm; 14AWG Max.) Plastic HPC-05BMMB-SR7001 (Ø4.5 ~Ø6.0mm; 14AWG Max.) |
| None - Certified NMEA 2000 (4A, 60V) | | Metal 12-05BMMB-SR7001 (Ø4.5 ~Ø6.0mm; 18AWG Max.) | 12-05BFFB-SR7001 (Ø4.5 ~Ø6.0mm; 18AWG Max.) |
| | | Plastic 12P-05BMMB-SR7001 (Ø4.5 ~Ø6.0mm; 18AWG Max.) | 12P-05BFFB-SR7001 (Ø4.5 ~Ø6.0mm; 18AWG Max.) |

Unit: mm

▾ Micro > Field Installable (Straight)

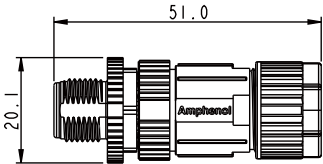
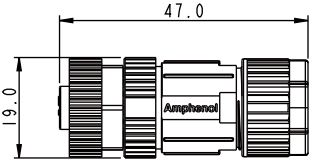
| <ul style="list-style-type: none"> • 5 contacts • Screw Thread • Screw-in Contacts • Mated IP67 | |  | |  | |
|---|---------|---|--|--|--|
| | | Unit: mm | | | |
| Connector | | Part Number (Male Connector / Male Contacts) | | Part Number (Female Connector / Female Contacts) | |
| Type | Metal | UMC-05BMMB-SL7001 (Ø4.5 ~ Ø7.5mm; 18AWG Max.) | | UMC-05BFFB-SL7001 (Ø4.5 ~ Ø7.5mm; 18AWG Max.) | |
| | Plastic | HMC-05BMMB-SL7001 (Ø4.5 ~ Ø6.0mm; 14AWG Max.) | | HMC-05BFFB-SL7001 (Ø4.5 ~ Ø6.0mm; 14AWG Max.) | |
| None - Certified NMEA 2000 (4A, 60V) | Metal | 12-05BMMB-SL7001 (Ø4.5 ~ Ø6.0mm; 18AWG Max.) | | 12-05BFFB-SL7001 (Ø4.5 ~ Ø6.0mm; 18AWG Max.) | |
| | Plastic | 12P-05BMMB-SL7001 (Ø4.5 ~ Ø6.0mm; 18AWG Max.) | | 12P-05BFFB-SL7001 (Ø4.5 ~ Ø6.0mm; 18AWG Max.) | |

【Note】 Design and specification are subject to change without notice.

Micro > Cable > T-Cable

| <ul style="list-style-type: none"> • 5 contacts • Screw Thread • For Power Tap Connection • Mated IP68 • Current Rating <ul style="list-style-type: none"> - Connector: 4A - Cable: 3A | | | | | | | | | |
|--|---------|-----------|--|----------------------|----------------------|----------|-------|-----------------------|--------|
| | | | | | | Unit: mm | | | |
| Type | | Connector | | End 1 | End 2 | End 1 | End 2 | End 1 | End 2 |
| | | | | Male | | Female | | Male | Female |
| Certified NMEA 2000 (3A, 60V) | Metal | | | - | - | | | UMC-050500-FM0-TSAXX* | |
| | Plastic | | | - | - | | | HMC-050500-FM0-TSAXX* | |
| None - Certified NMEA 2000 (3A, 60V) | Metal | | | MC-050500-MM0-TSBXX* | MC-050500-FF0-TSBXX* | | | MC-050500-FM0-TSBXX* | |
| | Plastic | | | PC-050500-MM0-TSBXX* | PC-050500-FF0-TSBXX* | | | PC-050500-FM0-TSBXX* | |

*XX: Cable length available in 1 (01), 2 (02), 5 (05), 10 (10)M.

Micro > Network Terminator > Terminator

| <ul style="list-style-type: none"> • 5 contacts • Screw Thread • With 120Ω Resistor • Mated IP68 | | | | | | | |
|--|---------|-----------|--|---|--|---|--|
| | | | | | | Unit: mm | |
| Type | | Connector | | Part Number (Male Connector / Male Contacts) | | Part Number (Female Connector / Female Contacts) | |
| | | | | | | | |
| Certified NMEA 2000 (3A, 60V) | Metal | | | HMC-05BMMT-SL8001 | | HMC-05BFFT-SL8001 | |
| | Plastic | | | HMCP-05BMMT-SL8001 | | HMCP-05BFFT-SL8001 | |

Micro > Network Terminator > Terminator

| | | | |
|--|---------|---|---|
| <ul style="list-style-type: none"> • 5 contacts • Screw Thread • With 120Ω Resistor • Mated IP68 | | | |
| Connector | | Part Number (Male Connector / Male Contacts) | Part Number (Female Connector / Female Contacts) |
| Certified NMEA 2000 (3A, 60V) | Metal | UMC-05BMMT-SL8001 | UMC-05BFFT-SL8001 |
| None - Certified NMEA 2000 (3A, 60V) | Metal | MC-05BMMT-SL8001 | MC-05BFFT-SL8001 |
| | Plastic | MCP-05BMMT-SL8001 | MCP-05BFFT-SL8001 |

Micro > Network Terminator > Terminator (In-Line)

| | | | | | |
|--|---------|----------------------|--------|---------------------|--------|
| <ul style="list-style-type: none"> • 5 contacts • Screw Thread • With 120Ω Resistor • Mated IP68 | | | | | |
| Connector | | End 1 | End 2 | End 1 | End 2 |
| Type | | Male | Female | Male | Female |
| Certified NMEA 2000 (4A, 60V) | Metal | HMC-000505-0MF-IS001 | | - | |
| | Plastic | HPC-000505-0MF-IS001 | | - | |
| None - Certified NMEA 2000 (4A, 60V) | Metal | | - | MC-000505-0MF-IS001 | |

[Note] Design and specification are subject to change without notice.

∟ Micro > Adaptor > T-Adaptor

| | | | |
|--|---------|---|--|
| <ul style="list-style-type: none"> • 5 contacts • Screw Thread • Mated IP68 | | | |
| | | Unit: mm | |
| Connector Type | | End 1 (Female Connector / Female Contacts) | |
| | | End 2 (Male Connector / Male Contacts) | |
| | | End 3 (Female Connector / Female Contacts) | |
| Certified NMEA 2000 (4A, 60V) | Metal | HMC-050505-FMF-TS001 | |
| | | UMC-050505-FMF-TS001 | |
| | Plastic | HPC-050505-FMF-TS001 | |

∟ Micro > Adaptor > Elbow (L-Adaptor)

| | | | |
|--|---------|---|---|
| <ul style="list-style-type: none"> • 5 contacts • Screw Thread • Mated IP68 | | | |
| | | Unit: mm | |
| Connector Type | | Part Number (Male Connector / Male Contacts) | Part Number (Female Connector / Female Contacts) |
| | | | |
| Certified NMEA 2000 (4A, 60V) | Metal | HMC-000505-0FM-ES001 | |
| | Plastic | HPC-000505-0FM-ES001 | |
| None - Certified NMEA 2000 (4A, 60V) | Metal | MC-000505-0FM-ES001 | |

Micro > Multi-port T-Adaptor

| | | | |
|--|-----------|---|---|
| <ul style="list-style-type: none"> • 5 contacts • Screw Thread • Mated IP68 | | | |
| | | Unit: mm | |
| Type | Connector | End 1 (Female Connector / Female Contacts) | End 1 (Female Connector / Female Contacts) |
| | | End 2 (Female Connector / Female Contacts) | End 2 (Female Connector / Female Contacts) |
| | | End 3 (Female Connector / Female Contacts) | End 3 (Female Connector / Female Contacts) |
| | | End 4 (Male Connector / Male Contacts) | End 4 (Female Connector / Female Contacts) |
| | | - | End 5 (Female Connector / Female Contacts) |
| | | - | End 6 (Male Connector / Male Contacts) |
| Certified NMEA 2000 (4A, 60V) | Metal | E-555500-FFFM00-S001 | E-555555-FFFFFM-S001 |
| | Plastic | H-555500-FFFM00-S001 | H-555555-FFFFFM-S001 |
| None - Certified NMEA 2000 (4A, 60V) | Metal | P-555500-FFFM00-S001 | P-555555-FFFFFM-S001 |
| | | S-555500-FFFM00-S001 | S-555500-FFFM00-S001 |

【Note】 Design and specification are subject to change without notice.

Micro > Multi-port > Box

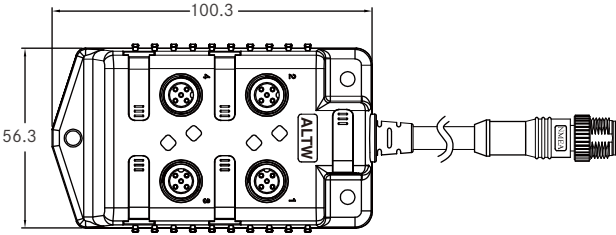
| | |
|--------------------------------------|--|
| • Unmated IP68 |  |
| | Unit: mm |
| Type | Part Number |
| None - Certified NMEA 2000 (4A, 30V) | S-555500-FFFF00-SBXX* |
| Certified NMEA 2000 (4A, 30V) | E-555500-FFFF00-SAXX* |

* XX: Cable length available from 01 ~ 99m

Micro > Waterproof Cap

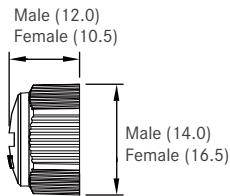
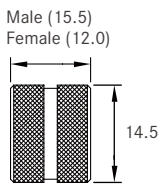
| | | | | <p>* Plastic</p>  | <p>* Metal</p>  |
|-------|--------------------------------------|--------------|---------------|--|--|
| | | | | Unit: mm | |
| Size | Mating Pair | Mating Style | Mating Gender | Part Number | |
| Micro | Receptacle | Screw Thread | Male | CAP-WBDMSPB2 | |
| | Receptacle and Overmolded with Cable | | Male | CAP-WBDMSMA1 (Plastic) | |
| | | | Male | CAP-WBDMSMA2 (Metal) | |
| | | | Female | CAP-WBDFSMA1 (Plastic) | |
| | | | Female | CAP-WBDFSMA2 (Metal) | |

Mini > Bulkhead (Double-ended)

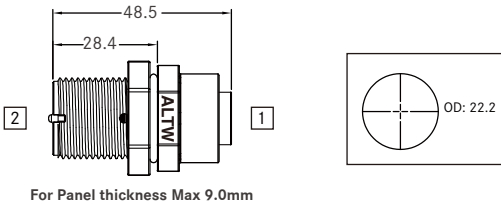
| | |
|---|---|
| <p>• Unmated IP68</p>  <p style="text-align: right;">Unit: mm</p> | |
| <p>Connector Type</p> | <p>Connector 1 (Female Connector / Female Contacts)</p> |
| | <p>Connector 2 (Male Connector / Male Contacts)</p> |
| <p>None - Certified NMEA 2000 (8A, 60V)</p> | <p>MN-000505-0FM-BS001</p> |
| <p>Certified NMEA 2000 (8A, 60V)</p> | <p>UMN-000505-0FM-BS001</p> |

Mini > Cable > Drop Line

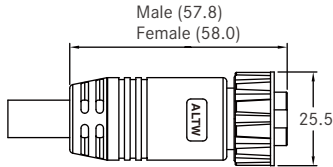
| | | |
|---|---|---|
| <p>• Mated IP68</p>  <p style="text-align: right;">Unit: mm</p> | | |
| <p>Type</p> | <p>Part Number (Male Connector / Male Contacts)</p> | <p>Part Number (Female Connector / Female Contacts)</p> |
| <p>None - Certified NMEA 2000 (8A, 30V)</p> | <p>MN-05AMMM-SL8CXX*</p> | <p>MN-05AFFM-SL8CXX*</p> |
| <p>Certified NMEA 2000 (8A, 60V)</p> | <p>UMN-05AMMM-SL8CXX*</p> | <p>-</p> |

*XX: Cable length available in 1 (01), 2 (02), 5 (05), 10 (10)M.

[Note] Design and specification are subject to change without notice.

↳ Mini > Cable > Double-ended Cordset

| | | |
|--|---|-------------------------------------|
| <ul style="list-style-type: none"> • Mated IP68 | | <p>* Available in 1, 2, 5, 10 M</p> |
| Connector Type | Connector 1 (Male Connector / Male Contacts) | |
| | Connector 2 (Female Connector / Female Contacts) | |
| None - Certified NMEA 2000 (8A, 30V) | MN-000505-0MF-CSCXX* | |
| Certified NMEA 2000 (8A, 60V) | UMN-000505-0MF-CSCXX* | |

*XX: Cable length available in 1 (01), 2 (02), 5 (05), 10 (10)M.

↳ Mini > Field Installable

| | | | |
|---|---|---|------------------------|
| <ul style="list-style-type: none"> • Screw-in Contacts • Mated IP68 | | <p>* Conforming to NMEA</p> | <p>* NMEA approved</p> |
| Type | Part Number (Male Connector / Male Contacts) | Part Number (Female Connector / Female Contacts) | |
| None - Certified NMEA 2000 (8A, 60V) | MN-05BMMB-SL7001 | MN-05BFFB-SL7001 | |
| Certified NMEA 2000 (8A, 60V) | UMN-05BMMB-SL7001 | UMN-05BFFB-SL7001 | |

Unit: mm

* Recommended Cable Information:
 - None-Certified: Ø8 ~ Ø11mm; 15AWG Max.
 - Certified NMEA 2000: Ø8 ~ Ø12.2mm; 15AWG Max.

Mini > T-Cable

| | | |
|--|---|----------|
| <ul style="list-style-type: none"> • Mated IP68 | | |
| | | Unit: mm |
| Connector Type | Connector 1 (Female Connector / Female Contacts) | |
| | Connector 2 (Male Connector / Male Contacts) | |
| None - Certified NMEA 2000 (8A, 30V) | MN-050500-FM0-TSCXX* | |

*XX: Cable length available in 1 (01), 2 (02), 5 (05), 10 (10)M.

Mini > Network Terminator

| | | | | |
|--|---|---|---|----------|
| <ul style="list-style-type: none"> • With 120Ω Resistor • Mated IP68 | <ul style="list-style-type: none"> * Conforming to NMEA * Signal function LED | | <ul style="list-style-type: none"> * NMEA approved | |
| | | | | Unit: mm |
| Type | Part Number (Male Connector / Male Contacts) | Part Number (Female Connector / Female Contacts) | | |
| None - Certified NMEA 2000 (8A, 250V) | MNL-05BMMT-SL8001 | MNL-05BFFT-SL8001 | | |
| Certified NMEA 2000 (8A, 250V) | UMN-05AMMT-SL8001 | UMN-05AFFT-SL8001 | | |

[Note] Design and specification are subject to change without notice.

∟ Mini > T-Adaptor

| | | | |
|--|---|-----------------------------|--|
| <p>• Mated IP68</p> | | | |
| | | Unit: mm | |
| <p>Connector</p> <p>Type</p> | <p>Connector 1 (Female Connector / Female Contacts)</p> | | |
| | <p>Connector 2 (Male Connector / Male Contacts)</p> | | |
| | <p>Connector 3 (Female Connector / Female Contacts)</p> | | |
| <p>None-Certified NMEA 2000 (8A, 300V)</p> | | <p>MN-050505-FMF-TS001</p> | |
| <p>Certified NMEA 2000 (8A, 300V)</p> | | <p>UMN-050505-FMF-TS001</p> | |

∟ Mini > Adaptor > Elbow (L-Adaptor)

| | | | |
|--|---|----------------------------|--|
| <p>• Mated IP68</p> | | | |
| | | Unit: mm | |
| <p>Connector</p> <p>Type</p> | <p>Connector 1 (Female Connector / Female Contacts)</p> | | |
| | <p>Connector 2 (Male Connector / Male Contacts)</p> | | |
| <p>None-Certified NMEA 2000 (8A, 300V)</p> | | <p>MN-000505-0FM-ES001</p> | |

Mini > Power Tap Tee

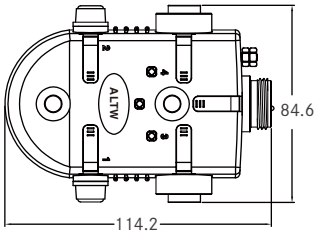
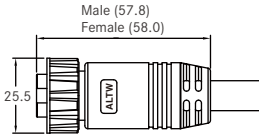
| | | |
|---|---|---|
| <ul style="list-style-type: none"> • With replaceable fuse • Mated IP68 |  | <p>Recommended Mating Pair MN-04AFFM-SL8DXX</p> <p>Male (57.8) Female (58.0)</p>  <p>*XX: Cable length available in 1(01), 2(02), 5(05), 10(10)M.</p> <p>Unit: mm</p> |
| <p>Connector</p> <p>Type</p> | Connector 1 (Male Connector / Male Contacts) | |
| | Connector 2 (Female Connector / Female Contacts) | |
| | Connector 3 (Female Connector / Female Contacts) | |
| None-Certified NMEA 2000 (8A, 250V) | N-455000-MFF000-S001 | |
| Certified NMEA 2000 (8A, 250V) | U-455000-MFF000-S001 | |

Mini > Waterproof Cap

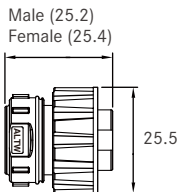
| | | | | |
|--|---|--------------|---------------|--------------|
| <ul style="list-style-type: none"> • 5 Contacts • Screw Thread • Mated IP68 |  <p>Male (25.2) Female (25.4)</p> <p>Unit: mm</p> | | | |
| Size | Mating Pair | Mating Style | Mating Gender | Part Number |
| Mini | Receptacle and Overmolded with Cable | Screw Thread | Female | CAP-WMNMSMA1 |
| | | | Male | CAP-WMNFSA1 |

[Note] Design and specification are subject to change without notice.

↳ Mini to Micro > T-Adaptor

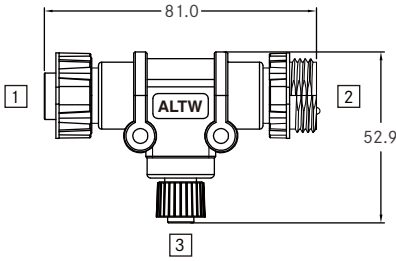
| | | | |
|--|---|---|--|
| <p>• Mated IP68</p> | |  <p style="text-align: right;">Unit: mm</p> | |
| <p>Connector</p> | <p>Connector 1 (Female Connector / Female Contacts)</p> | | |
| | <p>Connector 2 (Male Connector / Male Contacts)</p> | | |
| | <p>Connector 3 (Female Connector / Female Contacts)</p> | | |
| <p>Type</p> | | | |
| <p>None- Certified NMEA 2000 (4A, 60V)</p> | <p>NC-050505-FMF-TS001</p> | | |
| <p>Certified NMEA 2000 (4A, 60V)</p> | <p>UNC-050505-FMF-TS001</p> | | |

↳ Mini to Micro > I-Adaptor

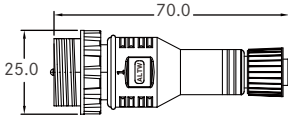
| | | | |
|--|----------------------------|--|--|
| <p>• Mated IP68</p> | |  <p style="text-align: right;">Unit: mm</p> | |
| <p>Type</p> | <p>Part Number</p> | | |
| <p>None- Certified NMEA 2000 (4A, 60V)</p> | <p>NC-000505-0MF-IS001</p> | | |

X-ON Electronics

Largest Supplier of Electrical and Electronic Components

Click to view similar products for [Sensor Cables / Actuator Cables](#) category:

Click to view products by [Amphenol](#) manufacturer:

Other Similar products are found below :

[60963](#) [60964](#) [703000D02F2002](#) [703001D02F0602](#) [703001D02F300](#) [704000D02F120](#) [773032K02F030](#) [802027107404-1](#) [802027213811-1](#)
[804001A09M150](#) [805001A09M0502](#) [84914-0235](#) [84914-0237](#) [885030A09M020](#) [8R4J30E03C3003](#) [1200651332](#) [1200651713](#) [1200660844](#)
[1200660845](#) [1200661173](#) [1200680071](#) [1200720053](#) [1200720081](#) [1200720099](#) [1200720217](#) [1200800231](#) [1200860125](#) [1200870123](#)
[1200980102](#) [1200650267](#) [1200650298](#) [1200660183](#) [1200660782](#) [1200660849](#) [1200661295](#) [1200661297](#) [1200661342](#) [1200661343](#)
[1200670080](#) [1200670220](#) [1200680331](#) [1200720252](#) [1200730184](#) [1200860344](#) [1200870359](#) [1200870643](#) [1200980008](#) [1200980031](#)
[1210502211](#) [1210400542](#)