



# Look No Further...

## Specifically made for all your: Gigabit Ethernet, HDMI, USB 2.0/3.0 Needs!

Amphenol Aerospace now offers a connector series that can be used for all of your multi-media needs. This series is capable of running Gigabit Ethernet, USB 2.0/USB 3.0, HDMI and 10 Gigabit Ethernet when specified and designated to a specific configuration. MRC is a micro-miniature connector ideal for Commercial, Industrial and Military Communication Systems. Its compact size combined with its IP67 performance rating makes it ideal for the harshest environmental situations.

The MRC flange mounting plugs are supplied with rigid contacts that are flat to the front surface of the connector. This feature allows it to be used in applications such as ruggedized displays, radios, and routers that have potential to come in contact with dirt and sand during use. The MRC can be easily cleaned by simply wiping off debris whereas standard pin and socket style connectors tend to be more difficult to remove debris once it has been compacted in the contacts.

The MRC cable assemblies feature connectors with spring loaded contacts and two coupling styles (Push/Pull and Push w/ ¼ turn lock). Both of these coupling styles mate with the standard flange mounting plug. Cable assemblies are available in various lengths and can either be supplied as double ended with MRC connectors on both ends or with standard COTS RJ45, USB, HDMI connections on one end. Additional cable materials and connector configuration are available; please consult our product team with your requirements.



## MRC Series Specifications

CURRENT RATING	2.5 AMPS Max Per Contact
PROTOCOLS SUPPORTED	Gigabit Ethernet, USB 2.0/3.0, 10 Gigabit Ethernet, & HDMI
DURABILITY	2000 Mating Cycles
UNMATING FORCE	4lb. Min
TEMPERATURE RANGE	-65° to 100° C (cable rating)

## Materials & Finishes

SHELLS	Aluminum Alloy
CONTACTS	Copper Alloy, Gold Plated
INSULATORS	Polyphenylene Sulfide (PPS), Teflon
CANTED COIL SPRING	Stainless Steel, Gold Plated

For further information, contact our product specialist, Catalin Brandas at 607-563-5665 or [cbrandas@amphenol-aao.com](mailto:cbrandas@amphenol-aao.com).

*Amphenol's New Multi-Media Ruggedized Connectors are Ideal for Communication Systems in Harsh Environments.*





# Chassis Mount Plug - How to Order

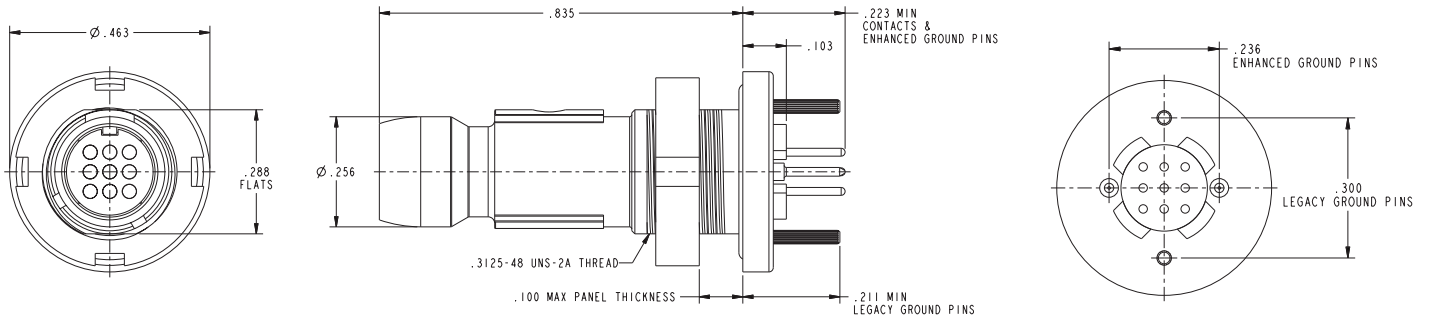

## 9 Pin

1. Series	2. Shell Style	3. Service Class	4. Alternate Keying Position	Grounding Pins
MRC9	7	C	N	G

SERIES	
MRC9	9 Pin MRC Connector

SHELL STYLE	
7	PC Jam Nut Panel Mount Plug
2	PC Square Flange

SERVICE CLASS	
Finish	
C	OD Cadmium
E	Electroless Nickel
D	Durmalon
Z	Black Zinc Nickel
G	Green Zinc Nickel
B	Black Electroless Nickel

KEYING		
Key Position	AB°	AC°
N	120	210
A	150	210
B	95	210
C	120	275
D	150	275

GROUNDING PINS	
Omit	Legacy Ground Pins
G	Enhanced Ground Pin
N	Non-grounded

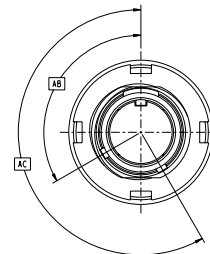
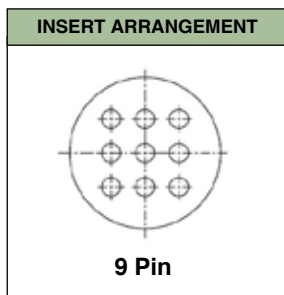



# Ethernet Cable Assemblies - How to Order

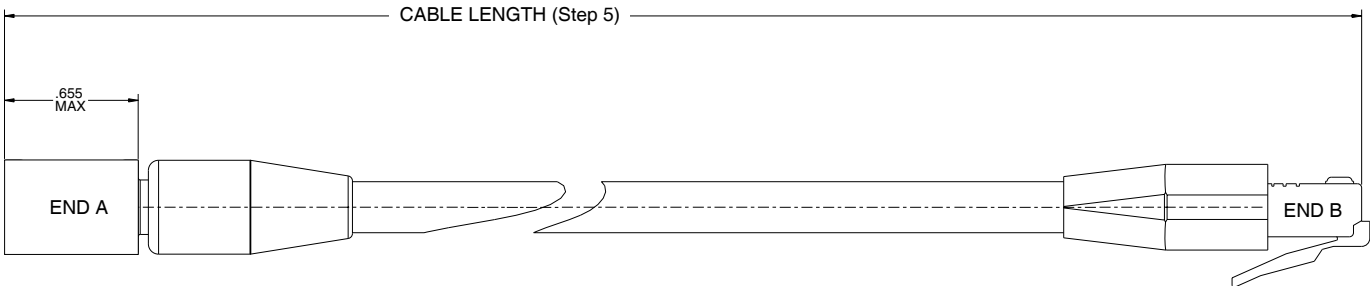

1. Series	2. Cable Side A	3. Service Class	4. Alternate Keying Position (Side A)	5. Cable Length in Inches	6. Cable Side B
MRC9	1	C	N	24	EM

SERIES	
MRC9	9 Pin MRC Connector

SERVICE CLASS	
Finish	
C	OD Cadmium
E	Electroless Nickel
D	Durmalon
Z	Black Zinc Nickel
G	Green Zinc Nickel
B	Black Electroless Nickel

**CABLE LENGTH**  
Determine the overall length of your cable from end to end in inches. For Ex. 24 = 24 Inches.

SHELL STYLE	
Connector Designator	Cable End A
1	Push-pull Receptacle (Spring Contacts)
3	Twist-lock Receptacle (Spring Contacts)

KEYING		
Key Position	AB°	AC°
N	120	210
A	150	210
B	95	210
C	120	275
D	150	275

SHELL STYLE	
Connector Designator	Cable End B
EM	Ethernet RJ45 Male Cat 6
E1	Push-pull Receptacle (Spring Contacts)
E3	Twist-lock Receptacle (Spring Contacts)

Note: All cables supplied with Black PVC Jackets, LSZH and other cable jacket types available upon request. Please contact factory.

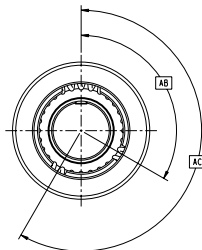



# Pig Tail Cable Assemblies - How to Order

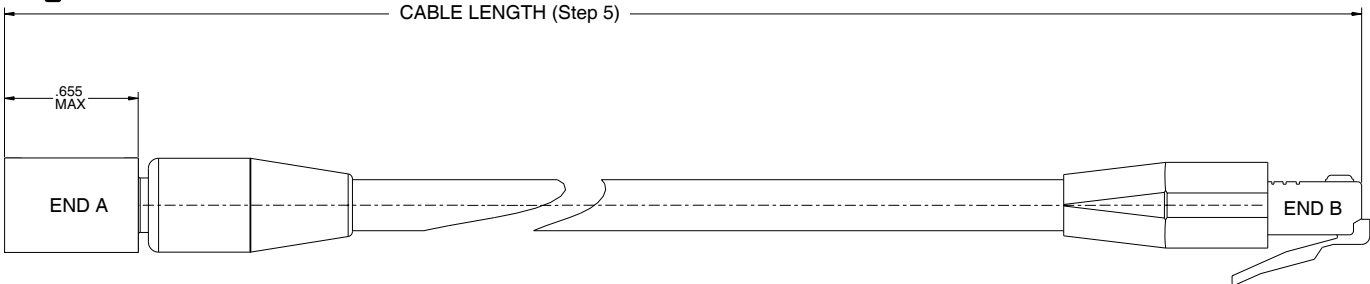

1. Series	2. Cable Side A	3. Service Class	4. Alternate Keying Position (Side A)	5. Cable Length in Inches	6. Cable Side B
MRC9	1	C	N	24	P

SERIES	
MRC9	9 Pin MRC Connector

SERVICE CLASS	
Finish	
C	OD Cadmium
E	Electroless Nickel
D	Duralon
Z	Black Zinc Nickel
G	Green Zinc Nickel
B	Black Electroless Nickel

**CABLE LENGTH**  
Determine the overall length of your cable from end to end in inches. For Ex. 24 = 24 Inches.

SHELL STYLE	
Connector Designator	Cable End A
1	Push-pull Receptacle (Spring Contacts)
3	Twist-lock Receptacle (Spring Contacts)

KEYING		
Key Position	AB°	AC°
N	120	210
A	150	210
B	95	210
C	120	275
D	150	275

SHELL STYLE	
Connector Designator	Cable End B
P	Pig Tail Wire
P1	Push-Pull Receptacle
P3	Twist-Lock Receptacle

Note: All cables supplied with Black PVC Jackets, LSZH and other cable jacket types available upon request. Please contact factory.

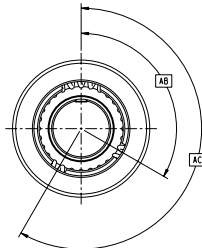



# USB 2.0/3.0 Cable Assemblies - How to Order

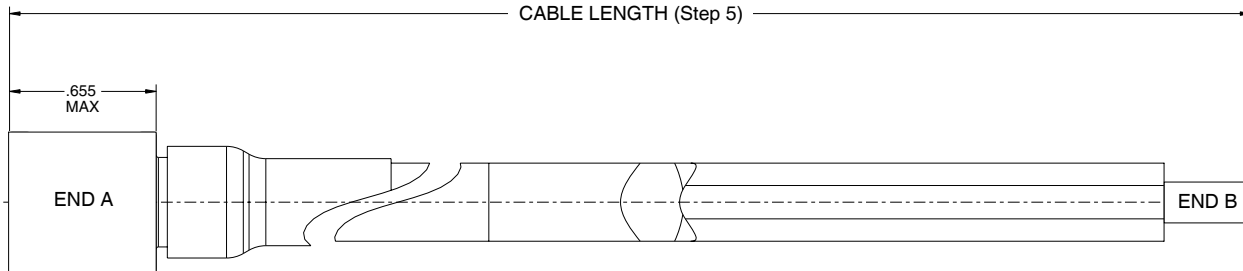

1. Series	2. Cable Side A	3. Service Class	4. Alternate Keying Position (Side A)	5. Cable Length in Inches	6. Cable Side B
MRC9	1	C	N	24	U1

SERIES	
MRC9	9 Pin MRC Connector

SERVICE CLASS	
Finish	
C	OD Cadmium
E	Electroless Nickel
D	Durmalon
Z	Black Zinc Nickel
G	Green Zinc Nickel
B	Black Electroless Nickel

**CABLE LENGTH**  
Determine the overall length of your cable from end to end in inches. For Ex. 24 = 24 Inches.

SHELL STYLE	
Connector Designator	Cable End A
1	Push-pull Receptacle (Spring Contacts)
3	Twist-lock Receptacle (Spring Contacts)

KEYING		
Key Position	AB°	AC°
N	120	210
A	150	210
B	95	210
C	120	275
D	150	275

SHELL STYLE	
Connector Designator	Cable End B
U1	USB 2.0 Type A Male
U2	USB 2.0 Type A Micro B Male
U3	USB 3.0 Type A Male
U4	USB 3.0 Type A Female
U5	USB 3.0 Type A Micro B
U6	Push-pull Receptacle (Spring Contacts)
U7	Twist-lock Receptacle (Spring Contacts)

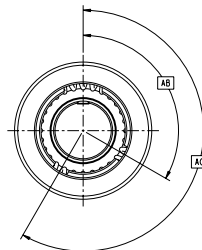

Note: All cables supplied with Black PVC Jackets, LSZH and other cable jacket types available upon request. Please contact factory.



# HDMI Chassis Mount Plug - How to Order

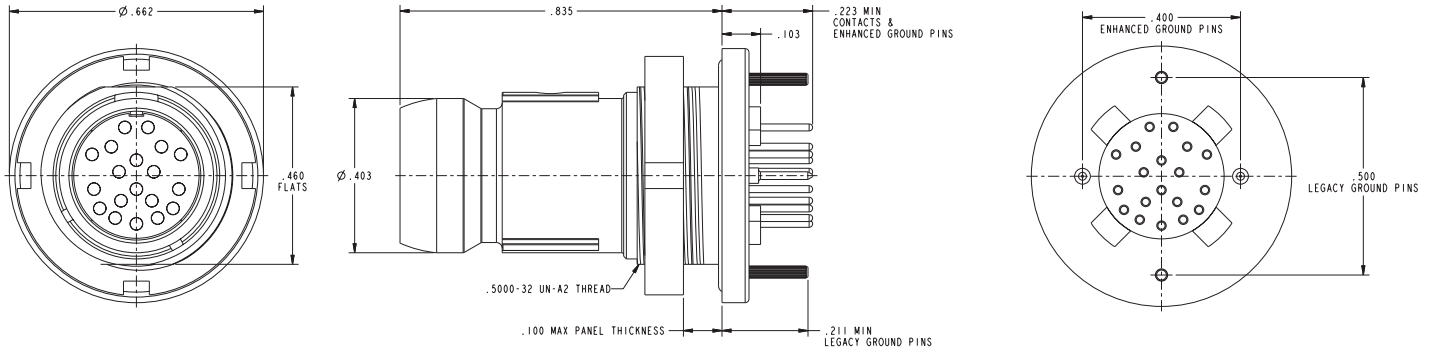

19 Pin

1. Series	2. Shell Style	3. Service Class	4. Alternate Keying Position	Grounding Pins
MRC19	7	C	N	G

SERIES	
MRC19	19 Pin MRC Connector

SHELL STYLE	
7	PC Jam Nut Panel Mount Plug
2	PC Square Flange

SERVICE CLASS	
	Finish
C	OD Cadmium
E	Electroless Nickel
D	Durmalon
Z	Black Zinc Nickel
G	Green Zinc Nickel
B	Black Electroless Nickel

KEYING		
Key Position	AB°	AC°
N	120	210
A	150	210
B	95	210
C	120	275
D	150	275

GROUNDING PINS	
Omit	Legacy Ground Pins
G	Enhanced Ground Pins
N	Non-grounded

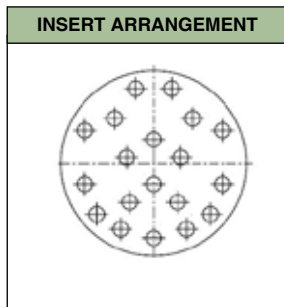

19 Pin

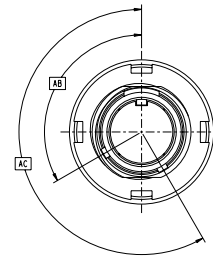



# HDMI Cable Assemblies - How to Order

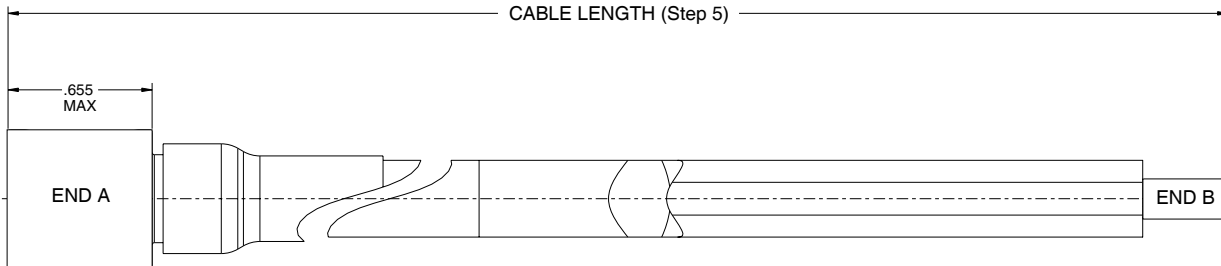

1. Series	2. Cable End A	3. Service Class	4. Alternate Keying Position (End A)	5. Cable Length in Inches	6. Cable End B
MRC19	1	C	N	24	H1

SERIES	
MRC19	19 Pin MRC Connector

SERVICE CLASS	
Finish	
C	OD Cadmium
E	Electroless Nickel
D	Durmalon
Z	Black Zinc Nickel
G	Green Zinc Nickel
B	Black Electroless Nickel

**CABLE LENGTH**  
Determine the overall length of your cable from end to end in inches. For Ex. 24 = 24 Inches.

SHELL STYLE	
Connector Designator	Cable End A
1	Push-pull Receptacle (Spring Contacts)
3	Twist-lock Receptacle (Spring Contacts)

KEYING		
Key Position	AB°	AC°
N	120	210
A	150	210
B	95	210
C	120	275
D	150	275

SHELL STYLE	
Connector Designator	Cable End B
H1	HDMI Male
H2	HDMI Male Mini
H3	Push-pull Receptacle (Spring Contacts)
H4	Twist-lock Receptacle (Spring Contacts)

Note: All cables supplied with Black PVC Jackets, LSZH and other cable jacket types available upon request. Please contact factory.

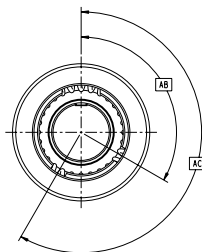



# Pig Tail Cable Assemblies - How to Order

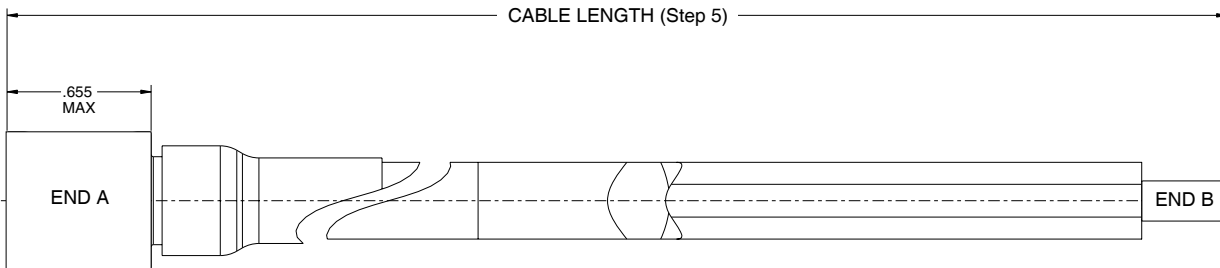

1. Series	2. Cable End A	3. Service Class	4. Alternate Keying Position (End A)	5. Cable Length in Inches	6. Cable End B
MRC19	1	C	N	24	P

SERIES	
MRC19	19 Pin MRC Connector

SERVICE CLASS	
Finish	
C	OD Cadmium
E	Electroless Nickel
D	Durmalon
Z	Black Zinc Nickel
G	Green Zinc Nickel
B	Black Electroless Nickel

**CABLE LENGTH**  
Determine the overall length of your cable from end to end in inches. For Ex. 24 = 24 Inches.

SHELL STYLE	
Connector Designator	Cable End A
1	Push-pull Receptacle (Spring Contacts)
3	Twist-lock Receptacle (Spring Contacts)

KEYING		
Key Position	AB°	AC°
N	120	210
A	150	210
B	95	210
C	120	275
D	150	275

SHELL STYLE	
Connector Designator	Cable End B
P	Pig Tail Wire
P1	Push-Pull Receptacle
P3	Twist-Lock Receptacle

Note: All cables supplied with Black PVC Jackets, LSZH and other cable jacket types available upon request. Please contact factory.

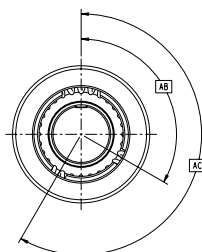





## Connector Options

### 1 - Push-pull Receptacle (Spring loaded Contacts)

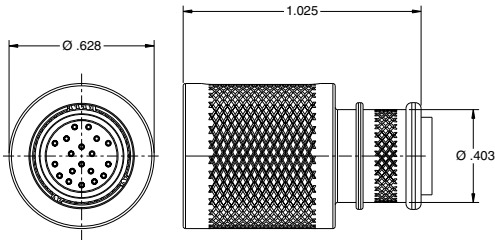
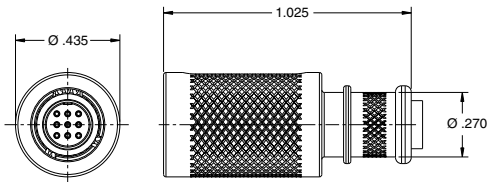

### 3 - Twist-lock Receptacle (Spring loaded Contacts)

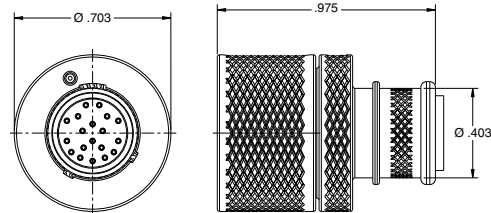
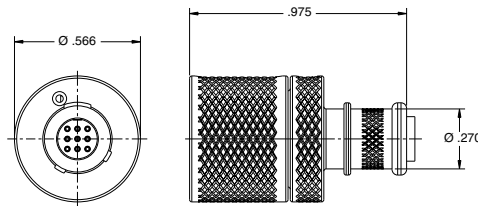

## MRC Solutions

The MRC panel mount connectors are also available with COTS connector assemblies. These assemblies allow the user to connect commercial cables inside their box or on the backside of a bulkhead. This type of assembly allows the user to ruggedize specific areas of the application while others can remain commercial. Please contact Amphenol with your requirements.



Notice: Specifications are subject to change without notice. Contact your nearest Amphenol Corporation Sales Office for the latest specifications. All statements, information and data given herein are believed to be accurate and reliable but are presented without guarantee, warranty, or responsibility of any kind, expressed or implied. Statements or suggestions concerning possible use of our products are made without representation or warranty that any such use is free of patent infringement and are not recommendations to infringe any patent. The user should assume that all safety measures are indicated or that other measures may not be required. Specifications are typical and may not apply to all connectors.

AMPHENOL is a registered trademark of Amphenol Corporation.

©2014 Amphenol Corporation Printed in U.S.A. REV 5/2014

**Amphenol**<sup>®</sup>  
Aerospace

Call 800-678-0141 or visit us at [www.amphenol-aerospace.com](http://www.amphenol-aerospace.com)

## X-ON Electronics

Largest Supplier of Electrical and Electronic Components

*Click to view similar products for [Modular Connectors](#) / [Ethernet Connectors](#) category:*

*Click to view products by [Amphenol](#) manufacturer:*

Other Similar products are found below :

[8949-H88/06BLKA/SN](#) [74441-0010/BKN](#) [MP1010RX-1000](#) [MP44RX-1000](#) [PHP-6P6C-5](#) [GAX-3-66](#) [GAX-8-62](#) [GDCX-PA-66-50](#) [GDCX-PN-64](#) [GDCX-PN-66](#) [GDCX-PN-66-50](#) [GDLX-A-66](#) [GDLX-N-66](#) [GDLX-S-66](#) [GDLX-S-88K](#) [GDTX-S-88-50](#) [GDX-PA-1010](#) [GLX-N-1010M-BLK](#) [GLX-S-88M-BLK](#) [GMX-N-1010](#) [GMX-S-1010](#) [GMX-S-66](#) [GMX-SMT4-N-88](#) [GPX-2-64](#) [GSGX-N-2-88](#) [GSGX-N-4-88](#) [GSX-NS2-88-3.05](#) [GSX-NS2-88-3.05-50](#) [GSX-NS-88-3.05-50](#) [GSX-NS-88-3.68](#) [PT-108A-8C-UL](#) [PT-J951-8C](#) [PTS-J531-8CS-50UL](#) [1-1775629-2](#) [A-2014-0-4](#) [GWLX-S-88-GR](#) [GWLX-S9-88-YG](#) [DC-1021-8-WH-6](#) [1300530003](#) [1324640-4](#) [RJ11FTVC2G](#) [RJ11FTVC2N](#) [RJFTVX2SA1G](#) [132764-001](#) [1413235](#) [MP88X-1000](#) [MPS88RX-5000](#) [MRJR-5481-0F2](#) [E5288-S000K3-L](#) [E5908-15A242-L](#)