

*So, you Want to Know Connectors . . . .*

## Amphenol's REFERENCE GUIDE to Cylindrical Connectors

*Learn the Amphenol Connector Language . . .*



L-1102-7

Printed 8/2008

# Amphenol

[www.amphenol-aerospace.com](http://www.amphenol-aerospace.com)  
[www.amphenol-industrial.com](http://www.amphenol-industrial.com)

This booklet is intended to be used as a ready reference to typical standard, miniature and subminiature cylindrical connector part numbers and terminology. Reading its brief pages will not make you a connector expert, but should guide you in becoming familiar with the product, in order to better serve our customers.

AAO, Amphenol Aerospace division of Amphenol Corporation, is the leading manufacturer of military aerospace interconnect products in the world. Brand names include Amphenol® and Pyle-National® and Matrix®.

AIO, Amphenol Industrial division of Amphenol Corporation, is a worldwide leader in the manufacture of industrial and powerbus interconnect products. Brand names include Amphenol® and Pyle-National®.

Note: Many of the connector products in this brochure were formerly known as "Bendix" products. These products are now manufactured and sold under the Amphenol® brand name. The name "Amphenol" will replace the name "Bendix" on products and literature in the future.

Amphenol operates a quality system that is third-party certified to ISO9001:2000 and AS9100.

For more information and for Amphenol catalogs online go to: [www.amphenol-aerospace.com](http://www.amphenol-aerospace.com) or [www.amphenol-industrial.com](http://www.amphenol-industrial.com).

Amphenol Corporation  
Amphenol Aerospace and  
Amphenol Industrial Operations  
40-60 Delaware Avenue  
Sidney, New York 13838-1395  
Phone: 800-678-0141 or 607-563-5011  
Fax: 607-563-5157

## Contents

### SECTION I

Nomenclature: Cylindrical Connectors ..... 1-3  
Basic Components

### SECTION II

Major MIL-Specifications by Type  
Standard, MIL-DTL-5015  
Amphenol 97 Series  
Heavy Duty, MIL-DTL-22992  
Proprietary Variations ..... 4-5  
MIL-DTL-5015 and 97 Series Part Number Breakdown  
MIL-DTL-22992 Part Number Breakdown

### SECTION III

Major MIL-Specifications by Type  
Miniature, MIL-DTL-26482 ..... 6-10  
MIL-DTL-26482 Part Number Breakdown  
Miniature Crimp, Solder Part Number Breakdown

### SECTION IV

Major MIL-Specifications by Type  
Subminiature, MIL-DTL-38999, MIL-DTL-27599 ..... 11-22  
Subminiature – JT/LJT, Tri-Start, SJT Features  
JT/LJT Part Number Breakdown and Specifications  
LJT-R/JT-R and Accessories Cross Reference List  
Tri-Start Series III Part Number Breakdown (metal,  
composite and Clutch-Lok)  
Tri-Start Specifications  
SJT Part Number Breakdown

### SECTION V

Cross Reference by MIL-Spec to Competitor's  
and Amphenol Part Numbers ..... 23-25  
Intermating Chart

### SECTION VI

Qualified Products List by Connector  
Specification ..... 26  
Amphenol®/Pyle®/Matrix® Quick Product Guide ..... 27-28

### SECTION VII

Know the Language ..... 29-31  
Basic Questions to Determine Connector Requirements ..... 32  
What Do You Need to Sell ..... Inside Back Cover  
Checklist  
Conclusion

NOTE: MIL-DTL-5015 supersedes MIL-C-5015  
MIL-DTL-22992 supersedes MIL-C-22992  
MIL-DTL-26482 supersedes MIL-C-26482  
MIL-DTL-38999 supersedes MIL-C-38999  
These MIL-spec numbers will be updated in catalogs as they are printed  
in the future.

# SECTION I

## Nomenclature: Cylindrical Connectors

### Basic Components

1. Shell (Houses Inserts & Contacts)
2. Insert (Dielectric Contact Insulator) Pin or Socket
3. Contact (Wire End Termination) (Electrical Engagement)
4. Coupling Nut
5. Accessories (Wire Seals, Cable Seals, Wire Support, etc.)

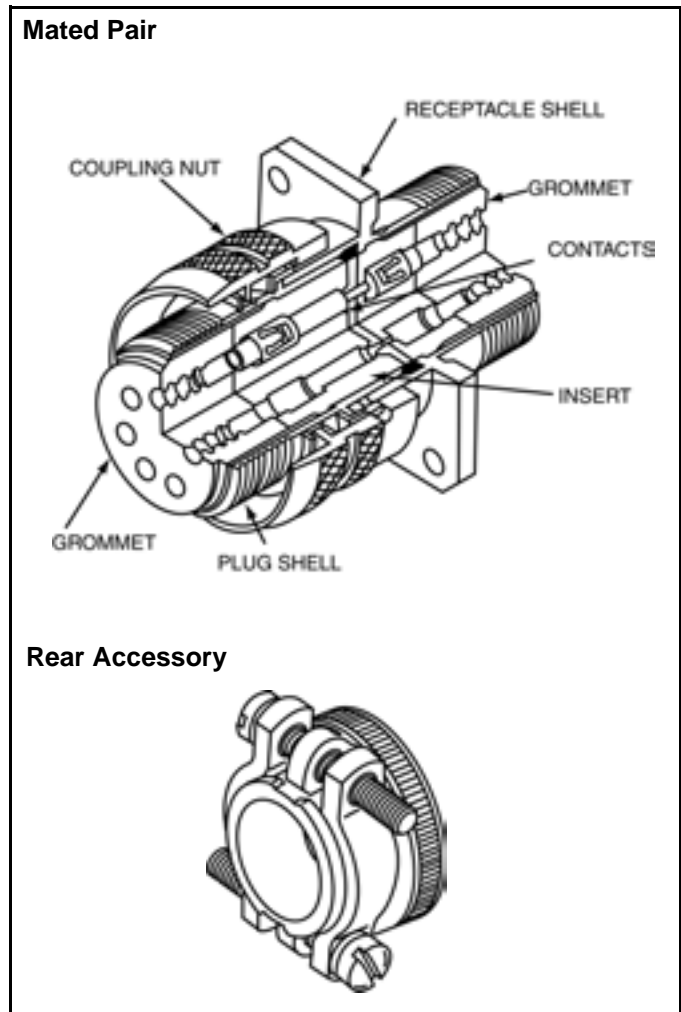
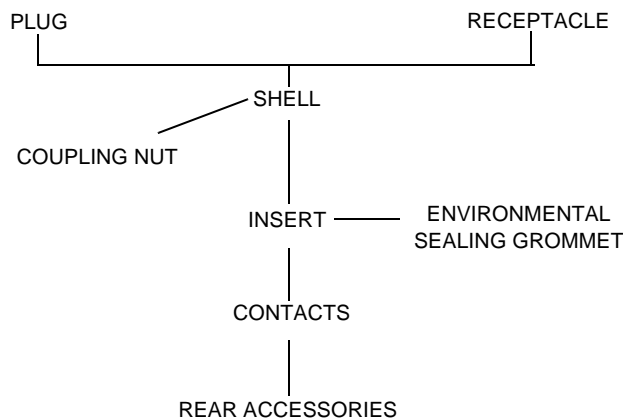

### Shell Styles

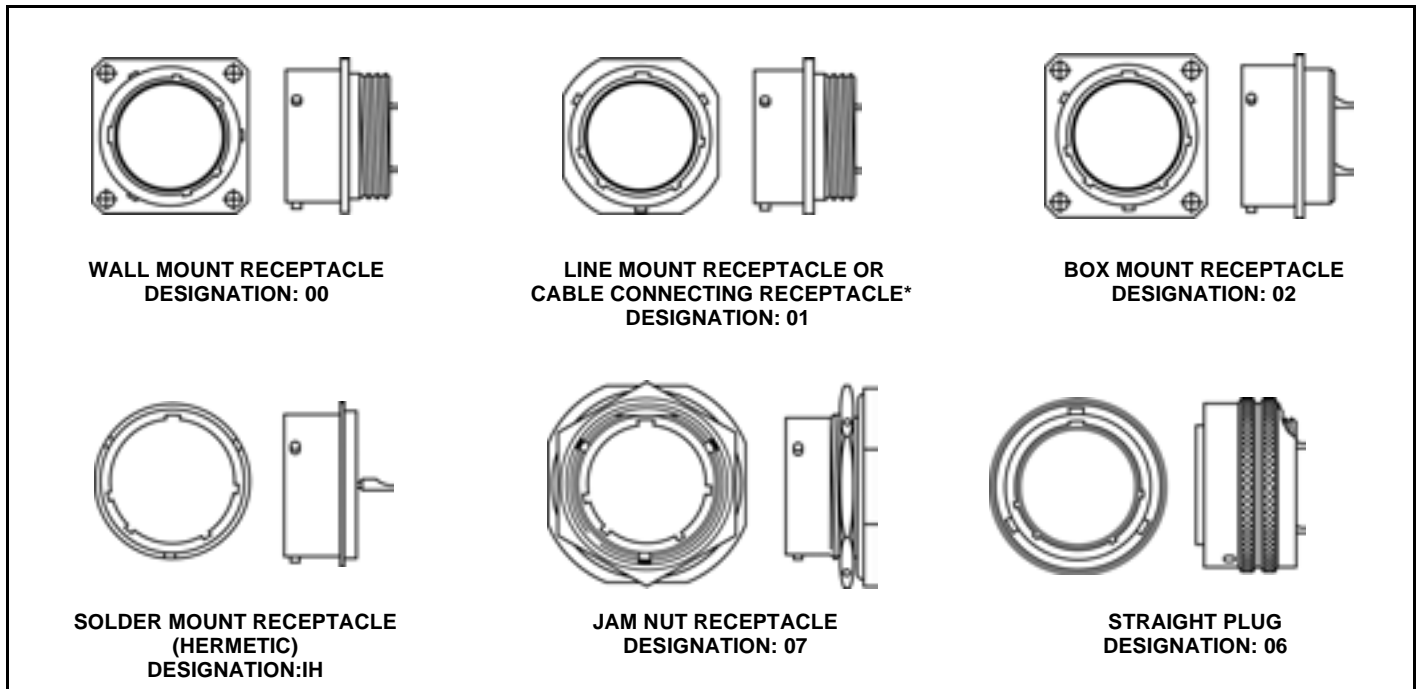

\* This connector style is sometimes referred to as a cable connecting "plug." It does, however, mate with either a straight or 90 degree plug.

# Nomenclature: Cylindrical Connectors and Contacts

## Shell Styles (Cont'd.)

### Coupling

Threaded, Bayonet

### Shell Sizes (Typical MIL-DTL-5015)

8S, 10S, 10SL, 12S, 12,  
14S, 14, 16S, 16, 18  
20, 22, 24, 28, 32, 36, 40, 44, 48

"S" designates short shell and short contacts

Shell size denotes mating thread diameter in 16ths of an inch. For example, a size 8 shell denotes 8/16 of an inch with a .5000-28 UNEF thread.

### Style Designation (PT)

| PLUG       | SHELL STYLES                              |
|------------|---|
| 06         | Straight                                  |
| 08         | Angle                                     |
| 09         | Flange Mount Receptacle                   |
| 05         | Straight, Less Rear Accessory             |
| RECEPTACLE | SHELL STYLES                              |
| 00         | Wall Mount                                |
| 01         | Cable Connecting or Line Mount Receptacle |
| 02         | Box Mount                                 |
| 03         | Wall Mount, Less Rear Accessory           |
| 04         | Line Mount, Less Rear Accessory           |
| 07         | Jam Nut                                   |
| IH         | Solder Mount Hermetic                     |

## Inserts

Insert  
(Pin or Socket)

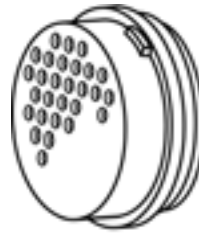

Insert & Grommet Assy.

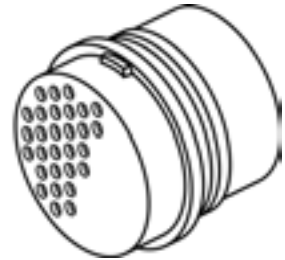

- Solder
- Crimp
- Metal Clip Retention
- Dielectric Retention

May include a soft front interfacial seal (Bonded) if dielectric is hard, and a rear sealing grommet separate or attached.

### Contact and Contact Termination Style

Pin – Crimp\*



Socket – Crimp\*



Pin – Solder

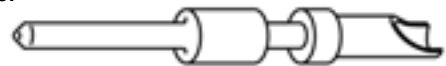

Socket – Solder



\*Crimp is removable

### Sizes by Wire Gauge, Examples:

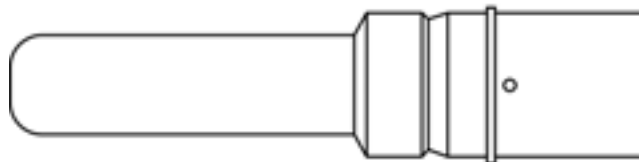

4/0 American Wire Gauge 4/0



22D American Wire Gauge 22-28

## Nomenclature: Cylindrical Connectors and Contacts, cont.

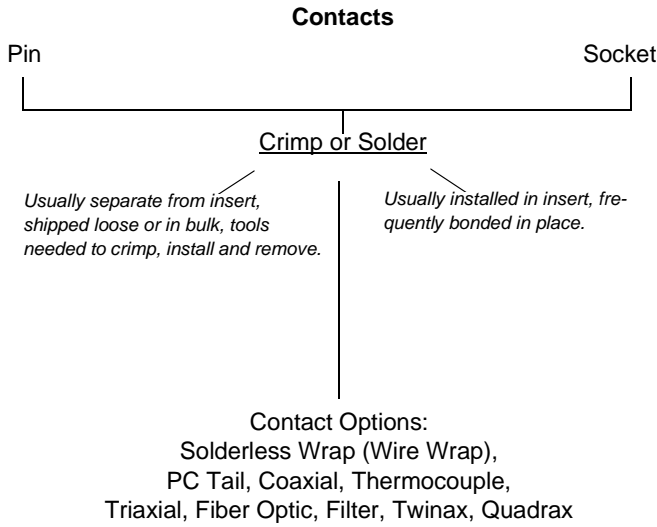

### Contact Sizes

| Contact Size        | 22D   | 22M   | 22    | 20    | 16    |
|---------------------|-------|-------|-------|-------|-------|
| American Wire Gauge | 22-28 | 24-28 | 22-26 | 20-24 | 16-20 |
| Wire Size (AWG)     |       |       |       |       |       |

| Contact Size        | 12    | 8    | 4   | 0   |
|---------------------|-------|------|-----|-----|
| American Wire Gauge | 12-14 | 8-10 | 4-6 | 0-2 |
| Wire Size (AWG)     |       |      |     |     |

### Accessories

- Adapters
  - straight, 90°, 75°
  - conduit, environmental, open wire bundle, EMI, etc.
- Compression ring – wire seal
- Clamp – cable sealing
- Stain relief – clamp, kellems grip
- Potting boot
  - straight, angle, universal

## Contact Versatility - Several types of Contacts can be designed into a Connector Shell

MIL-DTL-38999 connectors allow users to mix a variety of different power, signal, shielded, fiber optic and high speed contact styles within a common insert.

The insert arrangement below is an arrangement for Tri-Start MIL-DTL-38999 Series III connectors. It shows the variety of contacts that can be designed into a shell size 25. Typically, customers specify the contacts sizes and power they require and chose an existing arrangement that fits their needs. For special new configurations, engineering will design the arrangement of contacts to fit within material and performance criteria.

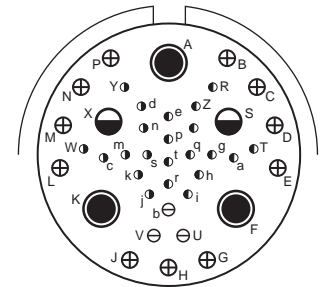

| Insert Arrangement | 25-41 |    |    |         |          |
|--------------------|-------|----|----|---------|----------|
| Number of Contacts | 22    | 3  | 11 | 2       | 3        |
| Contact Size       | 22D   | 20 | 16 | 12 Coax | 8 Twinax |



## Contacts and Fiber Optic Termini for Cylindrical Connectors

Amphenol's broad contact product range for Cylindrical Connectors includes:

- Standard 500 cycle and 1500 cycle, M39029 type power and signal contacts
- Crimp contacts for front or rear release connector applications
- Solder type, fixed contacts with cup or eyelet termination
- Thermocouple contacts
- RADSOK® sockets for high amperage power contacts
- Spring-loaded and push-pull types
- Filter contacts: Pi type tubular or Pi type planar for MF, HF, VHF, and UHF frequencies
- High frequency shielded coax, triax and twinax contacts
- High speed differential twinax and quadrax contacts
- For cylindrical connector attachment to Printed Circuit Boards:
  - PC tail contacts for signal and power applications, in coax, twinax, triax, differential twinax and quadrax designs
  - Compliant pin (Press fit) contacts
- Fiber optic Termini: MIL-T-29504 type or MT ferrules or ARINC 801 termini

# SECTION II

## Major MIL-Specifications by Type

- **Standard, MIL-DTL-5015**
  - **Amphenol 97 Series**
  - **Heavy Duty, MIL-DTL-22992**
  - **Proprietary Variations**
- Older larger series of connectors
  - Found on many pieces of military equipment and commercial applications
  - Mostly heavy current carrying connectors
  - Early types had only solder type contacts
  - Later revision to MIL Spec also added crimp type contacts
  - Amphenol supplies both the solder and crimp types to the MIL Spec
  - Amphenol supplies both solder and crimp versions under proprietary part numbers
  - Several variations of basic MIL-DTL-5015 and MIL-DTL-22992 types are available in the same and additional contact arrangements, such as the QWL, QWLD, 10-214000 Series, 10-244000 Series and others.
  - See Amphenol catalog sections:
    - MIL-DTL-5015 Cylindrical 12-020,
    - MIL-DTL-5015 Modifications 12-021,
    - Heavy Duty Cylindrical 12-052,
    - Commercial Aircraft Cylindrical 12-101,
    - 97 Series (MIL-DTL-5015 Proprietary) 12-022,
    - GT Series Bayonet 12-024.
  - Basic part number for MIL-DTL-5015 Series as supplied by Amphenol is MS310X A, C, E, F or R
  - MIL-DTL-5015 threaded coupling - 1 key/keyway shell polarization

| MIL-DTL-5015 Shell Styles |  |
|---------------------------|--|
| 3100                      | Wall Mount Receptacle                  |
| 3101                      | Cable Connecting Receptacle*           |
| 3102                      | Box Mount Receptacle                   |
| 3106                      | Straight Plug                          |
| 3108                      | 90° Plug                               |
| 3107                      | Quick Disconnect Plug (97 Series only) |

### Contact Sizes

| Contact Size                             | 16    | 12    | 8    | 4   | 0   |
|--|-------|-------|------|-----|-----|
| American Wire Gauge<br>Wire Size (AWG)** | 16-20 | 12-14 | 8-10 | 4-6 | 0-2 |

\* This connector style is sometimes referred to as a cable connecting "plug." It does, however, mate with either a straight or 90 degree plug.  
 \*\* Crimp adapter for small gauge wire is available, part number 10-074696-XXX.

## MIL-DTL-5015 Part Number

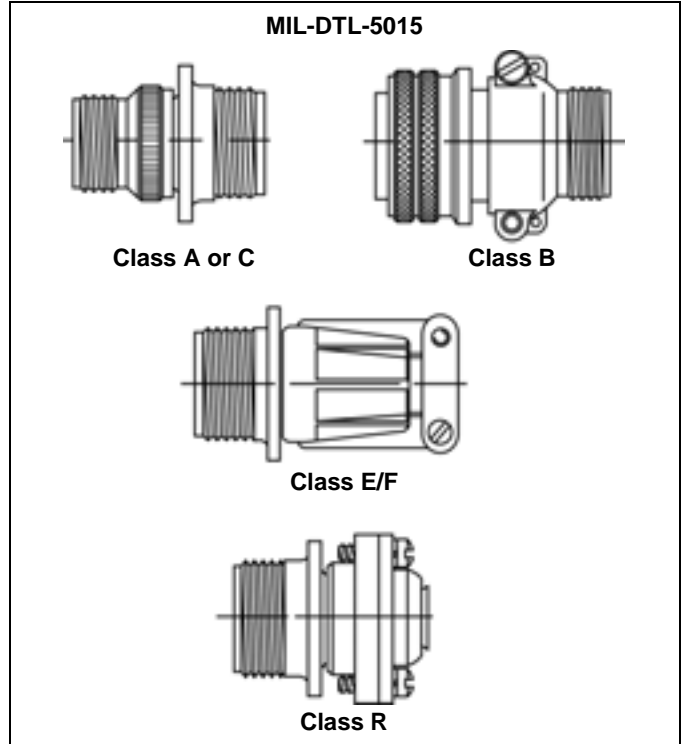
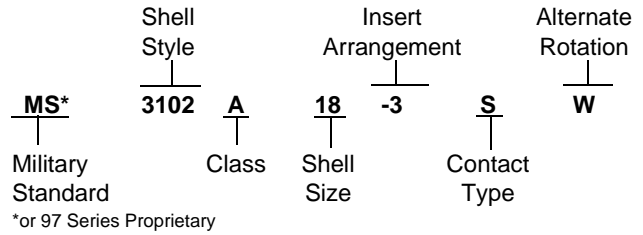

### Mating Halves

- Plugs: MS3106, MS3107, MS3108 or 97-3106, 97-3107, 97-3108
- Receptacles: MS3100, MS3102, MS3101, 97-3101, 97-3100, 97-3102

### Other Non-MIL-Mates, Flange Mounted

- Flange Mounted Plug: FP3106, 97-5105
- Thru-bulkhead Receptacle: TBF

See also 10-74XXX and 10-873XX in catalog section MIL-DTL-5015 Mods. for jam nut receptacles (Non-MIL)

### Alternate Positions of Insert Arrangements

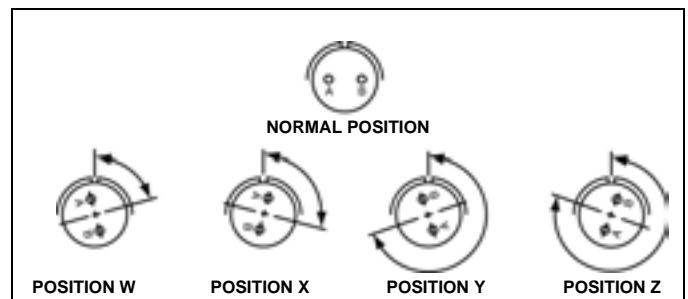

## Heavy Duty Cylindrical Connectors

- **Class L** - for the heaviest loads
  - Current range 40 to 200 amperes
  - Direct current or single/three phase, 60/400 Hertz alternating current
  - Automatic grounding for safety
- **QWLD** - for most power and control circuits
  - Military qualified connectors and commercial equivalents available
  - Increased shell size for greater durability than similar standard connectors
- **Class L and QWLD** have 5 key/keyway shell polarization and double stub thread coupling
- **QWL** – a more economical, compact heavy duty design for commercial power and control applications; single key shell polarization and double stub thread coupling

## MIL-DTL-22992 Series Connectors

### Classes C, R and L

#### Part Number Breakdown

The ordering procedure for QWLD MS-Approved Connectors is illustrated by part number MS17343R20N27PW as shown below:

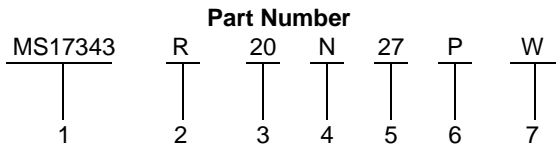

See code below:

1. MS Numbers
  - MS17343 designates wall mount receptacle
  - MS17344 designates straight plug
  - MS17345 designates cable connecting receptacle
  - MS17346 designates box mount receptacle
  - MS17347 designates jam nut receptacle with rear accessory threads (wall mount)
  - MS17348 designates jam nut receptacle (box mount)
2. Class
  - C designates pressurized; used where circuit integrity is protected by a pressure differential
  - R designates environmental; (see Heavy Duty Cylindrical catalog 12-052 for definition)
3. Shell Size
  - Available in shell sizes 12 through 44. See catalog 12-052 for dimensional data
4. Shell Finish
  - C for conductive or N for non-conductive
5. Insert Arrangement
  - Current MS insert arrangements are listed in catalog 12-052, Heavy Duty Cylindrical
6. Contact Type
  - “P” designates pin contacts; “S” for socket contacts

### 7. Alternate Insert Rotations:

Used to prevent cross-mating of connectors. Absence of a letter in this space indicates normal (0°) position of the insert. See catalog for alternate insert rotation illustrations.

See catalog 12-052 for proprietary equivalents such as 10-194XXX Series. Also see catalog 12-053 for QWL Series.

The ordering procedure for Class “L” Connectors is illustrated by part number MS90555C32412SY as shown below:

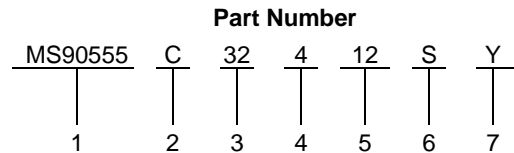

See code below:

### 1. MS Numbers

- MS90555 designates wall mount receptacle (power source)
- MS90556 designates straight plug
- MS90557 designates cable connecting receptacle without coupling ring
- MS90558 designates wall mount plug with coupling ring (equipment end)

### 2. Shell Finish

C (conductive) for AC or N (non-conductive) for DC circuits

### 3. Shell Size

Relates directly to current carrying capability

Size 28 – 40 amperes

Size 32 – 60 amperes

Size 44 – 100 amperes

Size 52 – 200 amperes

### 4. Main shell Key/keyway Position

N designates normal position. Three other positions (4, 5 and 6) of the main shell key/keyway prevent cross-mating or incompatible voltages. Refer to the individual connector style descriptions in catalog 12-052 for applicability.

### 5. Insert Arrangement

Determined by connector size (current carrying capability) and cable configuration to be accommodated. See catalog for insert arrangement pattern illustrations.

### 6. Contact Type

“P” designates pin contacts. “S” for socket contacts. MS90555 and MS90557 are supplied with socket contacts only. MS90556 and MS90558 are supplied with pin contacts only.

### 7. Alternate Insert Rotation

Used to prevent cross-mating of incompatible frequencies. Absence of a letter in this space indicates normal (0°) position of the insert. See catalog for individual insert arrangement description.

# SECTION III

## Major MIL-Specifications by Type

- Miniature, MIL-DTL-26482

### Miniature PT-Types MIL-DTL-26482

- Widely used smaller connectors
- Extensive use on military equipment including aircraft as well as commercial applications
- Available with either crimp or solder type contacts
- 3 point bayonet coupling
- Popular low cost series
- 5 Key/keyway shell polarization
- Amphenol supplies MIL-Spec types as well as proprietary versions
- MS311X or PT, solder type contacts (Series 1)
- MS312X or PT-SE, crimp type contacts (front release) (Series 1)
- MS347X or MB1, crimp type contacts (rear release) (Series 2)
- Modifications of Basic Series are:
  - PT-CE, crimp type contacts (front release) no MIL P/N, intermates with MS connectors
  - PC, double stub threaded coupling, bright cadmium plated, - (available with either crimp or solder contacts) no MIL P/N, does not intermate with PT types
  - SP, same as PT except wider flanges for back panel mounting, anodic coating, no MIL P/N, intermates with MS connectors
  - DC, same as PT except resistant to aircraft fluids, no MIL P/N, intermates with MS connectors
  - Other modifications and specials available
- For details on above series see Amphenol catalog sections:
  - “Miniature Cylindrical” 12-070
  - “Commercial Aircraft Cylindricals” 12-101.

MIL-DTL-26482 Series 2 is the same as MIL-DTL-83723 Series 1 and will intermate with all PT connectors. The Series features rear removable contacts – accessories are ordered separately. MIL-DTL-83723 Series 1 has been superseded by MIL-DTL-26482 Series 2.

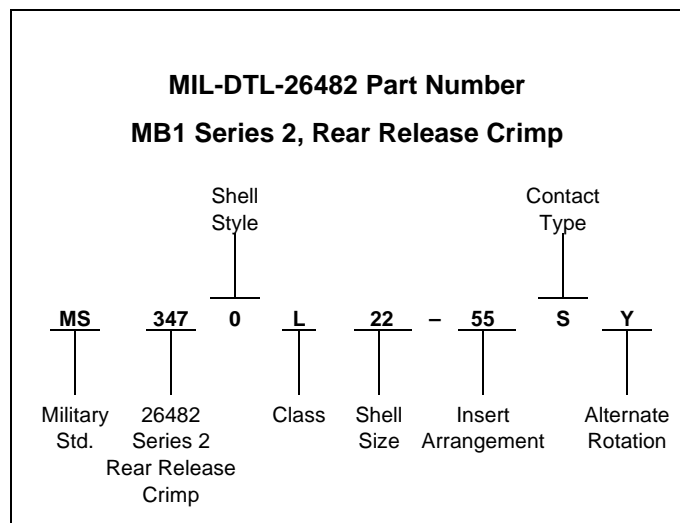
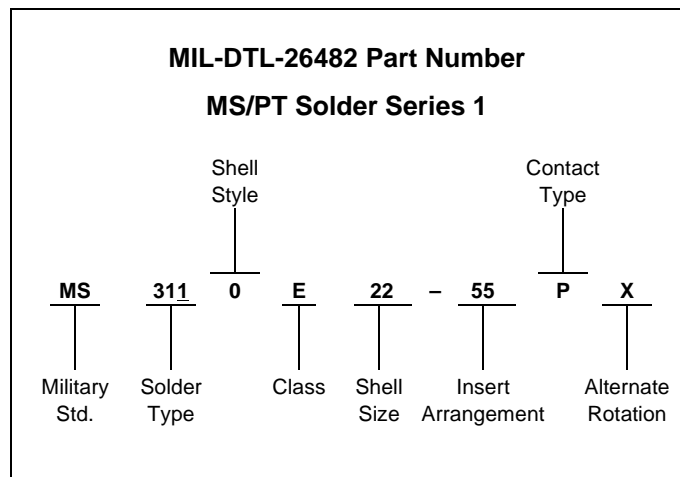
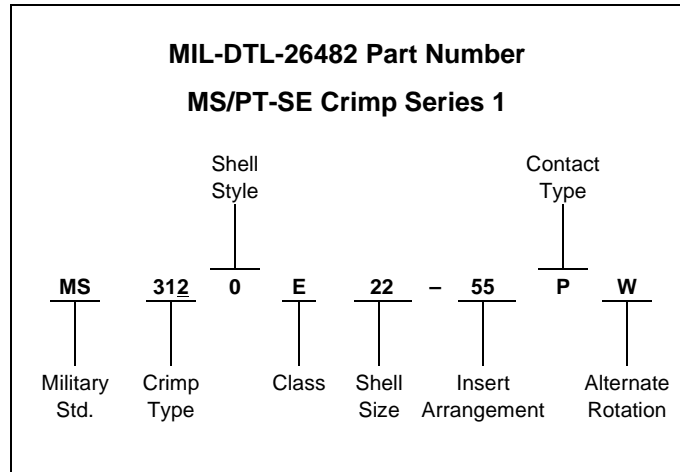



**How to Order BY MILITARY PART NUMBER**  
**MIL-DTL-26482 Series 2 Connectors**

|           |             |          |                       |          |          |
|-----------|-------------|----------|-----------------------|----------|----------|
| <u>MS</u> | <u>3470</u> | <u>W</u> | <u>12</u> – <u>10</u> | <u>P</u> | <u>W</u> |
| <u>1</u>  | <u>2</u>    | <u>3</u> | <u>4</u> <u>5</u>     | <u>6</u> | <u>7</u> |

1. Connector Type  
MS designates Military Standard
2. Connector Style  
3470 wall mounting receptacle with narrow flange  
3472 wall mounting receptacle with wide flange  
3471 cable connecting receptacle  
3474 jam nut receptacle  
3476 straight plug  
3475 straight plug with RFI grounding fingers
3. Service Class  
L aluminum shell, electroless nickel finish, fluid resistant insert  
A aluminum shell, black anodized finish, non-conductive fluid resistant insert  
W aluminum shell, olive drab cadmium plated, fluid resistant insert  
  
Note: For stainless steel shell, passivated, order by Amphenol®/Matrix® proprietary Class G.  
Class L inactivates older classes E and R (Ref. MIL-C-26482)
- 4., 5. Shell size and insert arrangement - See chart on page 9 and pattern drawings that follow.
6. Contact Types  
P designates pin  
S designates socket  
A designates less pins  
B designates less sockets  
  
Note: Use A & B only when other than a full complement of power contacts is to be installed.
7. Insert Rotation  
“W”, “X”, “Y”, “Z” designate that insert is rotated in its shell from normal position. No letter required for normal (no rotation) position.

**How to Order BY PROPRIETARY PART NUMBER**  
**MIL-DTL-26482 Series 2 Connectors**

|            |          |          |             |           |          |          |            |
|------------|----------|----------|-------------|-----------|----------|----------|------------|
| <u>MB1</u> | <u>0</u> | <u>W</u> | – <u>12</u> | <u>10</u> | <u>P</u> | <u>W</u> | <u>***</u> |
| <u>1</u>   | <u>2</u> | <u>3</u> | <u>4</u>    | <u>5</u>  | <u>6</u> | <u>7</u> | <u>8</u>   |

1. Connector Type  
MB1 designates Amphenol®/Matrix® Bayonet Coupling Connector
2. Connector Style  
0 wall mounting receptacle with narrow flange  
1 wall mounting receptacle with wide flange  
3 cable connecting receptacle  
4 jam nut receptacle  
6 straight plug  
8 straight plug with RFI grounding fingers
3. Service Class  
A aluminum shell, black anodize finish, non-conductive, fluid resistant insert  
R aluminum shell, electroless nickel finish, fluid resistant insert  
G stainless steel shell, passivated, fluid resistant insert  
W aluminum shell, cadmium plated, olive drab finish, fluid resistant insert
- 4., 5. Shell size and insert arrangement - See chart on page 9 and pattern drawings that follow.
6. Contact Types  
P designates pin  
S designates socket
7. Insert Rotation  
“W”, “X”, “Y”, “Z” designate that insert is rotated in its shell from normal position. No letter required for normal (no rotation) position.
8. Modification Number  
Consult Amphenol, Sidney, NY for information.  
For strain reliefs use the following modification codes:  
(189) E-nut M85049/31 configuration  
(190) Straight strain relief M85049/52 configuration  
(191) 90° strain relief M85049/51 configuration

For ordering information on accessories, such as protection caps and backshell hardware, contact Amphenol, Sidney, NY.

## Miniature Crimp Connectors Part Number Breakdown

### Proprietary Part Number Construction for Miniature Crimp Connectors

To more easily illustrate ordering procedures, part number PT00SE-20-41PW (SR) is shown as follows:

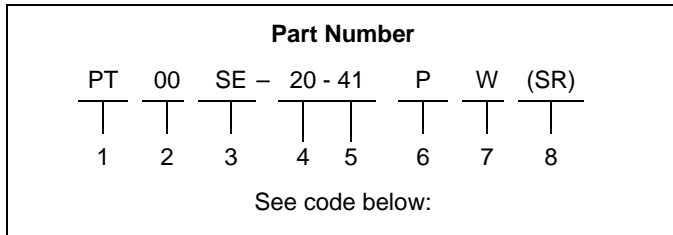

#### 1. Connector Family

PT designates standard olive drab cadmium plated Tri-Lock coupling connector

SP designates connector similar to PT except for anodic coating and larger flange and mounting holes for back panel mounting of receptacles

#### 2. Shell Style

"00" designates wall mount receptacle

"01" designates cable connecting receptacle

"02" designates box mount receptacle

"06" designates straight plug

"07" designates jam nut receptacle

"08" designates 90° plug

#### 3. Service Class

"SE" designates crimp, environmental (MIL-DTL-26482)

"SP" designates crimp, potted type (MIL-DTL-26482)

Both of the above are Amphenol proprietary versions of the MIL-DTL-26482 Series 1 crimp contact connector and offer 15 lbs. contact retention for size 20 contacts, 25 lbs. for size 16 contacts.

"CE" designates crimp, environmental

"CP" designates crimp, potted type

Both of the above are original Amphenol crimp connectors and offer 7 lbs. contact retention for size 20 contacts, 9 lbs. for size 16 contacts.

4. "20" designates shell size. Shell sizes available are 8 through 24.

5. "20-41" designates insert arrangement

6. "P" designates pin contacts; "S" for socket contacts

7. "W" designates that insert is rotated in its shell from the standard position to alternate position W. The basic rotations are W, X, Y, and Z. No letter required for normal (no rotation) position.

8. "SR" designates a strain relief clamp. Deviation suffixes would be inserted here. For example, (005) would indicate the metal parts (except contacts) would have anodic coating.

### Part Number Nomenclatures for MS/PT Crimp Connectors to MIL-DTL-26482 Specification

To more easily illustrate ordering procedures, part number MS3120E-20-41PW is broken down as follows:

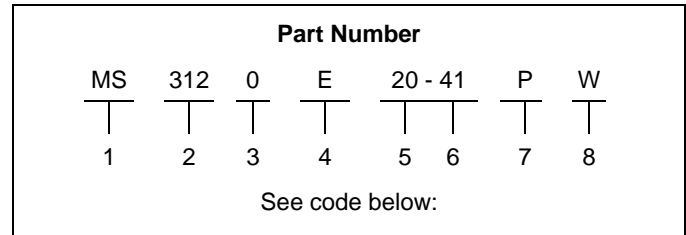

1. "MS" designates Military Standard

2. "312" designates basic family number for MIL-Spec 26482 crimp type

#### 3. Shell Style

"0" designates wall mount receptacle

"1" designates cable connecting receptacle

"2" designates box mount receptacle

"4" designates jam nut receptacle

"6" designates straight plug

"7" designates box mount receptacle with dual mounting holes

"8" designates wall mount receptacle with dual mounting holes

#### 4. Service Class

"E" designates environmental resisting connector

"F" designates environmental resisting connector with strain relief

"P" designates potted type with potting boot

5. "20" designates shell size. Shell sizes available are 8 through 24.

6. "20-41" designates insert arrangement

7. "P" designates pin contacts; "S" for socket contacts

8. "W" designates that the insert is rotated in its shell from the standard position to alternate position W. The basic rotations are W, X, Y, and Z. No letter required for normal (no rotation) position.

| Cross Reference - Commercial PT to Comparable Military MS Types |         |              |         |
|---|---------|--------------|---------|
| Amphenol P/N  | MS P/N  | Amphenol P/N | MS P/N  |
| PT00SE  | MS3120E | PT06SE(SR)   | MS3126F |
| PT01SE  | MS3121E | MF00SE(SR)   | MS3128F |
| PT02SE  | MS3122E | PT07SE(SR)   | MS3124F |
| PT06SE  | MS3126E | PT08SE(SR)   | None    |
| MF02SE  | MS3127E | PT00SP       | MS3120P |
| MF00SE  | MS3128E | PT01SP       | MS3121P |
| PT07SE  | MS3124E | PT02SP       | MS3122P |
| PT08SE  | None    | PT06SP       | MS3126P |
| PT00SE(SR)  | MS3120F | PT07SP       | MS3124P |
| PT01SE(SR)  | MS3121F |              |         |

## Miniature Solder Connectors Part Number Breakdown

### Part Number Nomenclature for Miniature Solder Connectors

To more easily illustrate ordering procedures, part number PT00A-20-41PW (SR) is shown as follows:

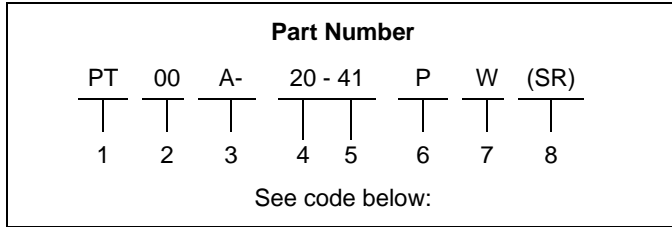

#### 1. Connector Family

PT designates standard olive drab cadmium plated Tri-Lock coupling connector. This is the Amphenol® proprietary version of the MIL-DTL-26482 solder contact connector.

PC designates a bright cadmium plated connector with double stub thread coupling

SP designates connector similar to PT except for anodic coating and larger flange and mounting holes for back panel mounting

#### 2. Shell Style

“00” designates wall mount receptacle

“01” designates cable connecting receptacle

“02” designates box mount receptacle

“06” designates straight plug

“07” designates jam nut receptacle

PTB designates thru-bulkhead receptacle

PTI designates solder mount receptacle

#### 3. Service Class

“A” designates general duty backshell

“C” designates pressurized receptacle

“E” designates environmental resisting with grommet and clamping nut

“J” designates clamp assembly for moisture proofing multi-jacketed cables, with strain relief

“P” designates potted with potting boot

“W” designates clamp assembly for moisture-proofing, multi-jacketed cables

“H” designates hermetic seal receptacle

4. “20” designates shell size. Shell sizes available are 6 through 24.

5. “20-41” designates insert arrangement

6. “P” designates pin contacts; “S” for socket contacts

7. “W” designates that insert is rotated in its shell from the standard position to alternate position W. The basic rotations are W, X, Y, and Z. No letter required for normal (no rotation) position.

8. “SR” designates a strain relief clamp. Deviation suffixes would be inserted here. For example, (005) would indicate the metal parts (except contacts) would have alumilite plating.

### Part Number Nomenclatures for MS/PT Solder Connectors to MIL-DTL-26482 Specification

To more easily illustrate ordering procedures, part number MS3110E20-41PW is shown as follows:

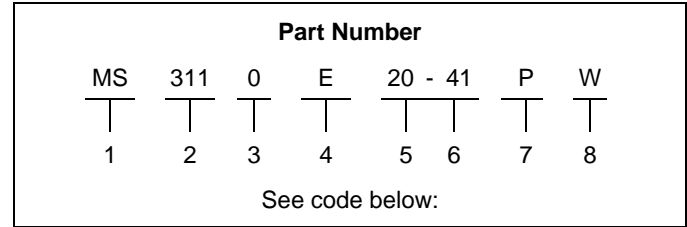

1. “MS” designates Military Standard

2. “311” designates basic family number for MIL-Spec 26482 solder type

#### 3. Shell Style

“0” designates wall mount receptacle

“1” designates cable connecting receptacle

“2” designates box mount receptacle

“4” designates jam nut receptacle

“6” designates straight plug

#### 4. Service Class

“E” designates environmental resisting connector with grommet and clamping nut

“F” designates environmental resisting connector with grommet and strain relief

“J” designates clamp assembly for moisture proofing multi-jacketed cables, with strain relief

“P” designates potted type with potting boot

5. “20” designates shell size. Shell sizes available are 8 through 24.

6. “20-41” designates insert arrangement

7. “P” designates pin contacts; “S” for socket contacts

8. “W” designates that the insert is rotated in its shell from the standard position to alternate position W. The basic rotations are W, X, Y, and Z. No letter required for normal (no rotation) position.

| Cross Reference - Commercial PT to Comparable Military MS Types |           |              |         |
|---|-----------|--------------|---------|
| Amphenol P/N  | MS P/N    | Amphenol P/N | MS P/N  |
| PT00A   | None      | PT00E(SR)    | MS3110F |
| PT01A   | None      | PT01E(SR)    | MS3111F |
| PT02A   | None      | PT06E(SR)    | MS3116F |
| PT06A   | None      | PT07E(SR)    | MS3114F |
| PT07A   | None      | PT00P        | MS3110P |
| PT00C   | None      | PT01P        | MS3111P |
| PT02C   | None      | PT02P        | None    |
| PT07C   | None      | PT06P        | MS3116P |
| PTB   | MS3119Ref | PT07P        | MS3114P |
| PT00E   | MS3110E   | PT00W        | None    |
| PT01E   | MS3111E   | PT01W        | None    |
| PT02E   | MS3112E   | PT06W        | None    |
| PT06E   | MS3116E   | PT02H        | None    |
| PT07E   | MS3114E   | PT07H        | MS3114H |
|   |           | PT1H         | MS3113H |

**Miniature Shell Styles**

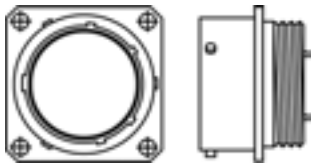

**Wall Mount Receptacle**

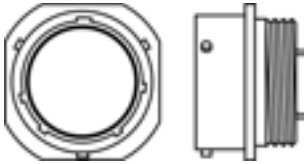

**Cable Connecting or Line Mount Receptacle\***

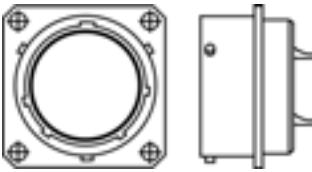

**Box Mount Receptacle**

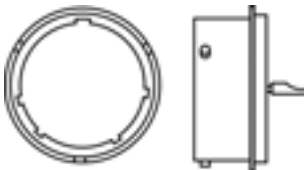

**Solder Mount Receptacle (Hermetic)**

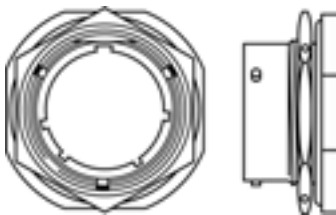

**Jam Nut Receptacle**

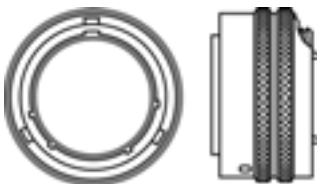

**Straight Plug**

Also see PTB - Thru-bulkhead, double-ended receptacle in Miniature Cylindrical catalog.

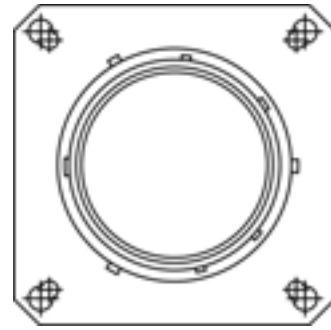

Wide Flange - Back Panel Mount:  
MS3127 Box Mount, MS3128 Wall Mount

**MIL-DTL-26482**



Class E

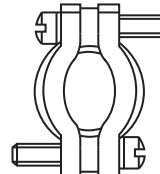

Class F

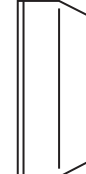

Class P

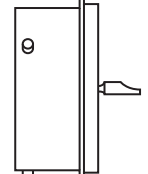

Class H

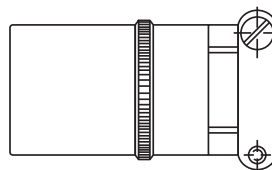

Class J

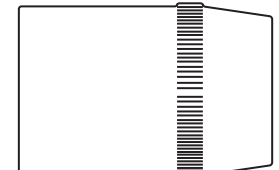

Class W  
(Non-MIL)

**Shell Sizes**

6, 8, 10, 12, 14, 16, 18, 20, 22, 24

**Contact Sizes**

|                                     |       |       |       |
|-------------------------------------|-------|-------|-------|
| Contact Size                        | 20    | 16    | 12    |
| American Wire Gauge Wire Size (AWG) | 20-24 | 16-20 | 12-14 |

\* This connector style is sometimes referred to as a cable connecting "plug." It does, however, mate with either a straight or 90 degree plug.

# SECTION IV

## Major MIL-Specifications by Type

- Subminiature, MIL-DTL-38999\*
- MIL-DTL-27599

### Subminiature - JT/LJT, Tri-Start, SJT

- Preferred for new design by the Military
- Greatest growth potential of all cylindricals
- "State of the Art" technology and performance
- MIL-DTL-27599 has molded-in solder type contacts
- MIL-DTL-38999 has rear release, crimp removable contacts
- SJT has features of both the JT and LJT and is a NATO preferred connector in Europe
- MIL-DTL-38999 Series I & II will not intermate
- MIL-DTL-27599 Series I & II will not intermate
- MIL-DTL-38999 and MIL-DTL-27599, Series I and II will intermate respectively
- For more information, see Amphenol catalog section:
  - 12-C1\*, Subminiature Cylindrical Connectors designed to MIL-DTL-38999 and MIL-DTL-27599
  - 12-C1\*, Tri-Start Connector - MIL-DTL-38999 Series III
  - 12-091, SJT - Proprietary MIL-DTL-38999 type
  - 12-130, High Frequency Contact Catalog

### MIL-DTL-27599

#### Series I (LJT-Solder)

- 100% scoop-proof
- Molded-in solder type contacts
- Options include PCB, wire wrap contacts
- High contact density (up to 128 contacts)
- Shell grounding fingers standard on all plugs
- Intermateable with MIL-DTL-38999 Series I
- Bayonet coupling
- 5 key/keyway polarization with 4 alternate keyings

#### Series II (JT-Solder)

- Low profile, light-weight, non-scoop-proof
- Molded-in solder type contacts
- Options include PCB, wire wrap contacts
- High contact density (up to 128 contacts)
- Shell grounding fingers available as option on plug
- Intermateable with MIL-DTL-38999 Series II
- Bayonet coupling
- 5 key/keyway polarization with 4 alternate keyings

### MIL-DTL-38999

#### Series I (LJT-R)

- 100% scoop-proof
- High density arrangements (up to 128 contacts)
- Contact sizes 12 through 22D plus size 16, 12, 8 coax, and size 8 twinax
- Bayonet coupling
- DOD preferred
- Corrosion resistant (500 hr. salt spray) finish available
- Removable crimp, PCB, wire wrap, twinax, and coax contacts available
- Options include Hermetics, Filters and Thermocouples
- 5 key/keyway polarization with 4 alternate keyings
- Shell grounding fingers are standard on all plug
- Triple-web grommet seal
- Available in a Fail Safe Lanyard Release plug: see Amphenol catalog 12-C1.

#### Series II (JT-R)

- High density arrangements (up to 128 contacts)
- Low silhouette, light-weight non-scoop-proof
- Bayonet coupling
- Contact sizes 12 through 22D plus size 16 & 12 coax
- 5 key/keyway polarization with 4 alternate keyings
- Removable crimp, PCB, wire wrap and coax contacts available
- Corrosion resistant (500 hr. salt spray) finish available
- Options include Hermetics, Filters and Thermocouples
- Shell grounding fingers on plugs are an option
- Triple-web grommet seal
- Available in Fail Safe Lanyard Release plug

\* Catalog 12-C1 is Amphenol's new catalog - combining 38999 Series I, II and III Connectors. These were formerly catalogs 12-090 (Series I, II) and catalog 12-092 (Series III). Consult Amphenol Aerospace for the availability of this new catalog.

## Subminiature JT/LJT Part Number Breakdown

### PROPRIETARY PART NUMBER

To more easily illustrate ordering procedure, part number JT00RE-22-2PA ( ) is shown as follows:

| Part Number |    |     |     |   |   |   |     |
|-------------|----|-----|-----|---|---|---|-----|
| JT          | 00 | RE- | 22- | 2 | P | A | ( ) |
| 1           | 2  | 3   | 4   | 5 | 6 | 7 | 8/9 |

See code below:

- Connector Type:
  - JT designates standard Junior Tri-Lock connector
  - LJT designates long Junior Tri-Lock connector
  - LJTS JTS designates high temperature connector
  - LJTN JTN designates chemical and fuel resistant
  - JTL designates miniature mounting dimensions
  - JTLN designates miniature mounting dimensions – chemical resistant
  - JTLS designates miniature mounting dimensions – high temperature
  - LJTPQ JTPQ designates back panel mounted wall mounting receptacle
  - LJTP JTP designates back panel mounted box mounting receptacle
  - LJTPN JTPN designates back panel mounted – chemical resistant
  - LJTPS JTPS designates back panel mounted – high temperature
  - JTG\* designates plug with grounding fingers
  - JTNG\* designates plug with grounding fingers – chemical resistant

\*Grounding fingers standard on all LJT plugs.

- Shell Style
  - “00” designates wall mount receptacle
  - “01” designates line mount receptacle
  - “02” designates box mount receptacle
  - “06” designates straight plug
  - “07” designates jam nut receptacle
  - “08” designates 90-degree plug
  - “I” designates solder mount receptacle – hermetic
- Service Class: Solder contacts/connectors
  - “P” for potting applications – These connectors are supplied with a potting boot.† All shells are designed with integral features to retain potting boots
  - “A” for general duty applications (JT series only)
  - “A (SR)” – threaded rear design with strain relief †
  - “C” for pressurized applications
  - “C” (SR)” – threaded rear design with strain relief †
  - “H” for hermetic applications – Fused compression glass sealed inserts. Leakage rate less than .01 micron cu. ft/hr. (1 x 10<sup>-7</sup> cc/sec.) at 15 psi differential.
  - “Y” same as “H” with interfacial seal
  - “T” for MS27599A applications – General duty – pressurized (receptacles only) (LJT series only)

- Service Class: Crimp contacts/connectors
  - “RP” for potting crimp applications – Supplied with spacer grommet and potting boot.†
  - “RE” for environmental crimp applications – Supplied with a grommet and compression nut† (JT Series only). Can be supplied with strain relief integral with compression nut “RE (SR).”
  - “RT” for environmental applications – Supplied without rear accessories. Design provides serrations on rear threads of shells. For additional information defining complete description of service class, consult Amphenol, Sidney, NY.
- Shell Size
  - JT shell sizes available from 8 through 24. LJT shell sizes available from 9 through 25.
- Insert Arrangement:
  - 22-2 designates insert arrangement. Refer to catalog 12-C1 for additional insert patterns.
- Contact Style
  - “P” designates pin contacts; “S” designates socket contacts.
- Alternating Keying
  - “A” designates alternate keying connector assembly. Other basic alternate keys are “B”, “C” and “D”. No letter required for normal (no rotation) position.
- “SR” designates a strain relief clamp. Strain reliefs are available only on “A”, “C” and “RE” class connectors.
- Finish variation suffix.

† Not applicable to box mounting style.

| Finish                               | Military Finish Data | Finish Suffix | Finish plus “SR” Suffix |
|--------------------------------------|----------------------|---------------|-------------------------|
| Cadmium plated nickel base           | A                    |               | (SR)                    |
| Olive drab cadmium plate nickel base | B                    | (014)         | (386)                   |
| Electroless nickel                   | F                    | (023)         | (424)                   |
| Anodic coating (Alumilite)           | C                    | (005)         | (300)                   |
| Chromate treated (Iridite 14-2)      |                      | (011)         | (344)                   |

### MILITARY TYPES

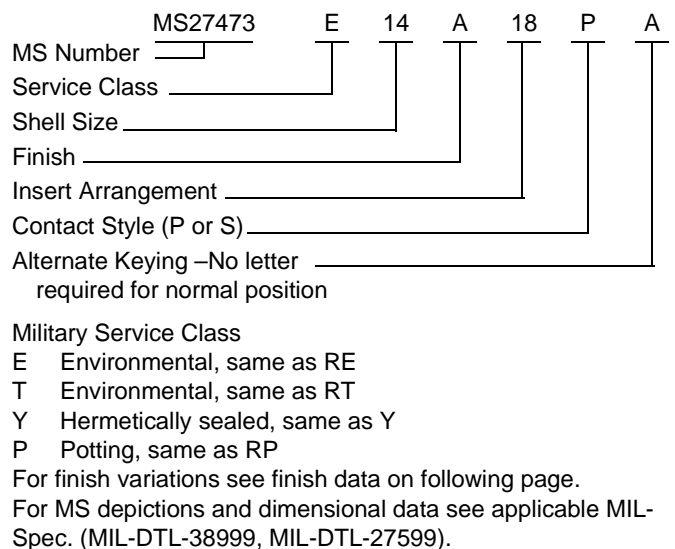

## Subminiature JT/LJT Specifications

### CONTACT RATING

| Contact Size | Test Current   |          | Maximum Millivolt Drop Crimp* | Maximum Millivolt Drop |           |
|--------------|----------------|----------|-------------------------------|------------------------|-----------|
|              | Solder & Crimp | Hermetic |                               | Solder*                | Hermetic* |
| 22M          | 3              | 2        | 45                            | 20                     | 60        |
| 22D          | 5              | 3        | 73                            |                        | 85        |
| 22           | 5              | 3        | 73                            | 20                     | 85        |
| 20           | 7.5            | 5        | 55                            | 20                     | 60        |
| 16           | 13             | 10       | 49                            | 20                     | 85        |
| 12           | 23             | 17       | 42                            | 20                     | 85        |
| 10 Power     | 33             | NA       | 33                            | NA                     | NA        |

| Contact Size | Crimp Well Data |                    | Solder Well Data                        |                    |
|--------------|-----------------|--------------------|---|--------------------|
|              | Well Diameter   | Nominal Well Depth | W Diameter                              | Nominal Well Depth |
| 22M          | .028 ± .001     | .141               | .029 <sup>+0.004</sup> <sub>-.000</sub> | .094               |
| 22D          | .0345 ± .0010   | .141               | .034 <sup>+0.004</sup> <sub>-.000</sub> | .094               |
| 22           | .0365 ± .0010   | .141               | .036 <sup>+0.004</sup> <sub>-.000</sub> | .094               |
| 20           | .047 ± .001     | .209               | .044 <sup>+0.004</sup> <sub>-.004</sub> | .125               |
| 16           | .067 ± .001     | .209               | .078 <sup>+0.000</sup> <sub>-.004</sub> | .141               |
| 12           | .100 ± .002     | .209               | .116 <sup>+0.004</sup> <sub>-.002</sub> | .141               |
| 10 Power     | .137 ± .002     | .355               | NA                                      | NA                 |

\* When tested using silver plated wire

### SERVICE RATING\*\*

| Service Rating | Suggested Operating Voltage (Sea Level) |      | Test Voltage (Sea Level) | Test Voltage 50,000 Ft. | Test Voltage 70,000 Ft. | Test Voltage 110,000 Ft. |
|----------------|---|------|--------------------------|-------------------------|-------------------------|--------------------------|
|                | AC (RMS)                                | DC   |                          |                         |                         |                          |
| M              | 400                                     | 500  | 1300 VRMS                | 550 VRMS                | 350 VRMS                | 200 VRMS                 |
| N              | 300                                     | 450  | 1000 VRMS                | 400 VRMS                | 260 VRMS                | 200 VRMS                 |
| I              | 600                                     | 850  | 1800 VRMS                | 600 VRMS                | 400 VRMS                | 200 VRMS                 |
| II             | 900                                     | 1250 | 2300 VRMS                | 800 VRMS                | 500 VRMS                | 200 VRMS                 |

\*\* Please note that the establishment of electrical safety factors is left entirely in the designer's hands, since he is in the best position to know what peak voltages, switching surges, transients, etc. can be expected in a particular circuit.

### FINISH DATA

| Aluminum Shell Components Non-Hermetic |          |             |   |                                     |
|--|----------|-------------|---|-------------------------------------|
| Finish                                 | Suffix   |             | Indicated Finish Standard for JT Types Listed Below | Standard for LJT Types Listed Below |
|  | Military | Proprietary |   |                                     |
| Cadmium Plated Nickel Base             | MS (A)   | -           | JT/JTG/JTL/JTP                                      | LJT/LJTP                            |
| Anodic Coating (Alumilite)             | MS (C)   | (005)       | JTS/JTPS/JTLS                                       | LJTSPS/LJTS                         |
| Chromate Treated (Iridite 14-2)        |          | (011)       | JTN/JTPN/JTLN                                       | LJTNP/JTPN                          |
| Olive Drab Cadmium Plate Nickel Base   | MS (B)   | (014)       |   |                                     |
| Electroless Nickel                     | MS (F)   | (023)       |   |                                     |

| Hermetic Connectors   |          |   |   |  |
|---|----------|---|---|--|
| Material Finish   | Suffix   |   | Indicated Finish Standard for JT Types Listed Below | Indicated Finish Standard for LJT Types Listed Below |
|   | Military | Proprietary                                   |   |  |
| Carbon Steel Shell<br>Tin Plated Shell and Contacts             |          |   | JT ( ) H/JT ( ) Y<br>JTL ( ) H/JTL ( ) Y            | LJT ( ) Y/LJT ( ) H                                  |
| Carbon Steel Shell<br>Tin Plated Shell and Gold Plated Contacts | MS (D)   | (452) special termination<br>(468) solder cup |   |  |
| Stainless Steel Shell<br>Gold Plated Contacts                   | MS (E)   | (162)   | JTS ( ) Y<br>JTLS ( ) Y                             | LJTS ( ) Y   |

**MIL-DTL-38999 LJT-R/JT-R and Accessories  
Cross Reference List**

| Series or Accessory | MS Part No.      | Amphenol Part No.         | Description                             |
|---------------------|------------------|---------------------------|---|
| Ac                  | MS27502AXXA      | 10-275197-XX7             | Cap. Recept. Series I<br>No Chain       |
| Ac                  | MS27502BXXA      | 10-275197-XX9             |   |
| Ac                  | MS27502FXXA      | 10-275197-XXG             |   |
| Ac                  | MS27501AXXA      | 10-275196-XX7             | Cap. Plug Series I,<br>No Chain         |
| Ac                  | MS27501BXXA      | 10-275196-XX9             |   |
| Ac                  | MS27501FXXA      | 10-275196-XXG             |   |
| Ac                  | MS27342AXX-1     | 10-440390-XX7 (Series II) | Adapter                                 |
| Ac                  | MS27342BXX-1     | 10-440390-XX9 (Series II) |   |
| Ac                  | MS27342CXX-1     | 10-440390-XX5 (Series II) |   |
| Ac                  | MS27342FXX-1     | 10-440390-XXG (Series II) |   |
| Ac                  | MS27342AXX-2     | 10-241055 Series II       |   |
| Ac                  | MS27342BXX-2     | 10-457452 Series I        |   |
| Ac                  | MS27342CXX-2     |                           |   |
| Ac                  | MS27342FXX-2     |                           |   |
| Ac                  | MS27510AXXA      | 10-241853-XX7             | Cap. Plug Series II,<br>No Chain        |
| Ac                  | MS27510BXXA      | 10-241853-XX9             |   |
| Ac                  | MS27510CXXA      | 10-241853-XX5             |   |
| Ac                  | MS27510FXXA      | 10-241853-XXG             |   |
| Ac                  | MS27511AXXA      | 10-241856-XX7             | Cap. Recept. Series II,<br>No Chain     |
| Ac                  | MS27511BXXA      | 10-241856-XX9             |   |
| Ac                  | MS27511CXXA      | 10-241856-XX5             |   |
| Ac                  | MS27511FXXA      | 10-241856-XXG             |   |
| I                   | MS27466EXXAXXP/S | LJT00RE-XX-XXP/S          | Wall Mount<br>Receptacle                |
| I                   | MS27466EXXBXXP/S | LJT00RE-XX-XXP/S (014)    |   |
| I                   | MS27466EXXFXXP/S | LJT00RE-XX-XXP/S (023)    |   |
| I                   | MS27466TXXAXXP/S | LJT00RT-XX-XXP/S          |   |
| I                   | MS27466TXXBXXP/S | LJT00RT-XX-XXP/S (014)    |   |
| I                   | MS27466TXXFXXP/S | LJT00RT-XX-XXP/S (023)    |   |
| I                   | MS27466PXXAXXP/S | LJT00RP-XX-XXP/S          |   |
| I                   | MS27466PXXBXXP/S | LJT00RP-XX-XXP/S (014)    |   |
| I                   | MS27466PXXFXXP/S | LJT00RP-XX-XXP/S (023)    |   |
| I                   | MS27467EXXAXXP/S | LJT06RE-XX-XXP/S          | Straight Plug                           |
| I                   | MS27467EXXBXXP/S | LJT06RE-XX-XXP/S (014)    |   |
| I                   | MS27467EXXFXXP/S | LJT06RE-XX-XXP/S (023)    |   |
| I                   | MS27467TXXAXXP/S | LJT06RT-XX-XXP/S          |   |
| I                   | MS27467TXXBXXP/S | LJT06RT-XX-XXP/S (014)    |   |
| I                   | MS27467TXXFXXP/S | LJT06RT-XX-XXP/S (023)    |   |
| I                   | MS27467PXXAXXP/S | LJT06RP-XX-XXP/S          | Straight Plug                           |
| I                   | MS27467PXXBXXP/S | LJT06RP-XX-XXP/S (014)    |   |
| I                   | MS27467PXXFXXP/S | LJT06RP-XX-XXP/S (023)    |   |
| I                   | MS27468EXXAXXP/S | LJT07RE-XX-XXP/S          | Jam Nut Mount<br>Receptacle             |
| I                   | MS27468EXXBXXP/S | LJT07RE-XX-XXP/S (014)    |   |
| I                   | MS27468EXXFXXP/S | LJT07RE-XX-XXP/S (023)    |   |
| I                   | MS27468TXXAXXP/S | LJT07RT-XX-XXP/S          |   |
| I                   | MS27468TXXBXXP/S | LJT07RT-XX-XXP/S (014)    |   |
| I                   | MS27468TXXFXXP/S | LJT07RT-XX-XXP/S (023)    |   |
| I                   | MS27468PXXAXXP/S | LJT07RP-XX-XXP/S          |   |
| I                   | MS27468PXXBXXP/S | LJT07RP-XX-XXP/S (014)    |   |
| I                   | MS27468PXXFXXP/S | LJT07RP-XX-XXP/S (023)    |   |
| I                   | MS27469YXXDXXP   | LJT00Y-XX-XXP             | Wall Mount Recept.,<br>Hermetic Seal    |
| I                   | MS27469YXXEXXP   | LJS00Y-XX-XXP             |   |
| I                   | MS27470YXXDXXP   | LJT07Y-XX-XXP             | Jam Nut Mount Recept.,<br>Hermetic Seal |
| I                   | MS27470YXXEXXP   | LJS07Y-XX-XXP             |   |
| I                   | MS27471YXXDXXP   | LJTIY-XX-XXP              | Solder Mount Recept.,<br>Hermetic Seal  |
| I                   | MS27471YXXEXXP   | LJTSIY-XX-XXP             |   |

| Series or Accessory | MS Part No.      | Amphenol Part No.     | Description   |
|---------------------|------------------|-----------------------|---|
| II                  | MS27472EXXAXXP/S | JT00R-EXX-XXP/S       | Wall Mount<br>Receptacle  |
| II                  | MS27472EXXBXXP/S | JT00RE-XX-XXP/S (014) |   |
| II                  | MS27472EXXCXXP/S | JTS00R-EXX-XXP/S      |   |
| II                  | MS27472EXXFXXP/S | JT00RE-XX-XXP/S (023) |   |
| II                  | MS27472TXXAXXP/S | JT00RT-XX-XXP/S       |   |
| II                  | MS27472TXXBXXP/S | JT00RT-XX-XXP/S (014) |   |
| II                  | MS27472TXXCXXP/S | JTS00RT-XX-XXP/S      |   |
| II                  | MS27472TXXFXXP/S | JT00RT-XX-XXP/S (023) |   |
| II                  | MS27472PXXAXXP/S | JT00RP-XX-XXP/S       |   |
| II                  | MS27472PXXBXXP/S | JT00RP-XX-XXP/S (014) |   |
| II                  | MS27472PXXCXXP/S | JTS00RP-XX-XXP/S      |   |
| II                  | MS27472PXXFXXP/S | JT00RP-XX-XXP/S (023) |   |
| II                  | MS27473EXXAXXP/S | JT06RE-XX-XXP/S       | Straight Plug   |
| II                  | MS27473EXXBXXP/S | JT06RE-XXP/S (014)    |   |
| II                  | MS27473EXXCXXP/S | JT06RE-XX-XXP/S       |   |
| II                  | MS27473EXXFXXP/S | JT06RE-XX-XXP/S (023) |   |
| II                  | MS27473TXXAXXP/S | JT06RT-XX-XXP/S       |   |
| II                  | MS27473TXXBXXP/S | JT06RT-XX-XXP/S (014) |   |
| II                  | MS27473TXXCXXP/S | JT06RT-XX-XXP/S       |   |
| II                  | MS27473TXXFXXP/S | JT06RT-XX-XXP/S (023) |   |
| II                  | MS27473PXXAXXP/S | JT06RP-XX-XXP/S       |   |
| II                  | MS27473PXXBXXP/S | JT06RP-XX-XXP/S (014) |   |
| II                  | MS27473PXXCXXP/S | JTS06RP-XX-XXP/S      |   |
| II                  | MS27473PXXFXXP/S | JT06RP-XX-XXP/S (023) |   |
| II                  | MS27474EXXAXXP/S | JT07RE-XX-XXP/S       | Jam Nut Mount<br>Receptacle                                       |
| II                  | MS27474EXXBXXP/S | JT07RE-XX-XXP/S (014) |   |
| II                  | MS27474EXXCXXP/S | JTS07RE-XX-XXP/S      |   |
| II                  | MS27474EXXFXXP/S | JT07RE-XX-XXP/S (023) |   |
| II                  | MS27474TXXAXXP/S | JT07RT-XX-XXP/S       |   |
| II                  | MS27474TXXBXXP/S | JT07RT-XX-XXP/S (014) |   |
| II                  | MS27474TXXCXXP/S | JTS07RT-XX-XXP/S      |   |
| II                  | MS27474TXXFXXP/S | JT07RT-XX-XXP/S (023) |   |
| II                  | MS27474PXXAXXP/S | JT07RP-XX-XXP/S       |   |
| II                  | MS27474PXXBXXP/S | JT07RP-XX-XXP/S (014) |   |
| II                  | MS27474PXXCXXP/S | JTS07RP-XX-XXP/S      |   |
| II                  | MS27474PXXFXXP/S | JT07RP-XX-XXP/S (023) |   |
| II                  | MS27475YXXDXXP   | JT00Y-XX-XXP          | Wall Mount Recept.,<br>Hermetic Seal                              |
| II                  | MS27475YXXEXXP   | JTS00Y-XX-XXP         |   |
| II                  | MS27476YXXDXXP   | JT02Y-XX-XXP          | Box Mount Recept.,<br>Hermetic Seal                               |
| II                  | MS27476YXXEXXP   | JTS0Y-XX-XXP          |   |
| II                  | MS27477YXXDXXP   | JT07Y-XX-XXP          | Jam Nut Mount Recept.,<br>Hermetic Seal                           |
| II                  | MS27477YXXEXXP   | JTS07Y-XX-XXP         |   |
| II                  | MS27478YXXDXXP   | JTIY-XX-XXP           | Solder Mount Recept.,<br>Hermetic Seal                            |
| II                  | MS27478YXXEXXP   | JTSIY-XX-XXP          |   |
| II                  | MS27479EXXCXXP/S | JTS00RE-XX-XXP/S      | Wall Mount Recept.,<br>Inactive, Use MS27472                      |
| II                  | MS27479TXXCXXP/S | JTS00RT-XX-XXP/S      |   |
| II                  | MS27480EXXCXXP/S | JTS06RE-XX-XXP/S      | Straight Plug, Inactive,<br>Use MS27473                           |
| II                  | MS27480TXXCXXP/S | JTS06RT-XX-XXP/S      |   |
| II                  | MS27481EXXCXXP/S | JTS07RE-XX-XXP/S      | Jam Nut Mount Recept.,<br>Inactive, Use MS27474                   |
| II                  | MS27481TXXCXXP/S | JTS07RT-XX-XXP/S      |   |
| II                  | MS27482YXXEXXP   | JTS00Y-XX-XXP         | Wall Mount Recept.,<br>Hermetic Seal, Inactive,<br>Use MS27475    |
| II                  | MS27483YXXEXXP   | JTS07Y-XX-XXP         | Jam Nut Mount Recept.,<br>Hermetic Seal, Inactive,<br>Use MS27477 |



**MIL-DTL-38999 LJT-R/JT-R and Accessories**  
**Cross Reference List (Cont.)**

| Series or Accessory | MS Part No.      | Amphenol Part No.              | Description                                |
|---------------------|------------------|--------------------------------|--|
| II                  | MS27484EXXAXXP/S | JTG06RE-XX-XXP/S               | Straight Plug with Grounding Spring        |
| II                  | MS27484EXXBXXP/S | JTG06RE-XX-XXP/S (014)         |  |
| II                  | MS27484EXXFXXP/S | JTG06RE-XX-XXP/S (023)         |  |
| II                  | MS27484TXAXXP/S  | JTG06RT-XX-XXP/S               |  |
| II                  | MS27484TXBXXP/S  | JTG06RT-XX-XXP/S (014)         |  |
| II                  | MS27484TXFXFP/S  | JTG06RT-XX-XXP/S (023)         |  |
| II                  | MS27484PXXAXXP/S | JTG06RP-XX-XXP/S               |  |
| II                  | MS27484PXXBXXP/S | JTG06RP-XX-XXP/S (014)         |  |
| II                  | MS27484PXXFXFP/S | JTG06RP-XX-XXP/S (023)         |  |
| Ac                  | MS27485AXX       | 10-528399-XX7                  | Ring, Potting Boot, Series II              |
| Ac                  | MS27485BXX       | 10-528399-XX9                  |  |
| Ac                  | MS27485CXX       | 10-528399-XX5                  |  |
| Ac                  | MS27485FXX       | 10-528399-XXG                  |  |
| Ac                  | MS27486-XX-1     | 10-241912-XX                   | Potting, Boot Straight, Series II          |
| Ac                  | MS27486-XX-2     | 10-241990-XX                   | Potting, Boot 90 Degree Series II          |
| Ac                  | MS27487-XX-1     | 10-450910-XX, Includes MS27489 | Kit, EMR Adapter, Straight, Series I & II  |
| Ac                  | MS27487-XX-2     | 10-450911-XX                   | Kit, EMR Adapter, 90 Degree Series I & II, |
| Ac                  | MS27488-12-1     | 10-405996-121                  | Plug, Sealing Grommet                      |
| Ac                  | MS27488-16-1     | 10-405996-161                  |  |
| Ac                  | MS27488-20-1     | 10-405996-201                  |  |
| Ac                  | MS27488-22-1     | 10-405996-241                  |  |
| Ac                  | MS27489-XXX      | 10-352425-XX                   | Adapter, Reducer EMR for use with MS27487  |
| I                   | MS27490-XX       | 10-407035-XX5                  | Contact-Socket                             |
| II                  | MS27491-XX       | 10-251416-XX5                  | Contact-Socket                             |
| II                  | MS27492-XX       | 10-251416-XXH                  | Contact-Socket, Inactive, use MS27491      |
| II                  | MS27493-XX       | 10-251415-XX5                  | Contact-Pin                                |
| II                  | MS27494-XX       | 10-251415-XXH                  | Contact-Pin, Inactive, use MS27493         |
| I & II              | MS27495R-XX      | 11-8675-XX                     | Tool, Contact, Removable, Metal            |
| I & II              | MS27495A-XX      | 11-8674-XX                     | Tool, Contact, Assembly, Metal             |
| I                   | MS27496EXXAXXP/S | LJT02RE-XX-XXP/S               | Box Mount Receptacle                       |
| I                   | MS27496EXXBXXP/S | LJT02RE-XX-XXP/S (014)         |  |
| I                   | MS27496EXXFXXP/S | LJT02RE-XX-XXP/S (023)         |  |
| II                  | MS27497EXXAXXP/S | JTPQ00RE-XX-XXP/S              | Back Panel Wall Mount Receptacle.          |
| II                  | MS27497EXXBXXP/S | JTPQ00RE-XX-XXP/S (014)        |  |
| II                  | MS27497EXXCXXP/S | JTPSQ00RE-XX-XXP/S             |  |
| II                  | MS27497EXXFXXP/S | JTPQ00RE-XX-XXP/S (023)        |  |
| II                  | MS27497TXXAXXP/S | JTPQ00RT-XX-XXP/S              |  |
| II                  | MS27497TXXBXXP/S | JTPQ00RT-XX-XXP/S (014)        |  |
| II                  | MS27497TXXCXXP/S | JTPSQ00RT-XX-XXP/S             |  |
| II                  | MS27497TXXFXFP/S | JTPQ00RT-XX-XXP/S (023)        |  |
| II                  | MS27497PXXAXXP/S | JTPQ002P-XX-XXP/S              |  |
| II                  | MS27497PXXBXXP/S | JTPQ002P-XX-XXP/S (014)        |  |
| II                  | MS27497PXXCXXP/S | JTPSQ002P-XX-XXP/S             |  |
| II                  | MS27497PXXFXFP/S | JTPQ00RP-XX-XXP/S (023)        |  |
| II                  | MS27497VXXAXXP/S | JTP00RE-XX-XXP/S               |  |
| II                  | MS27497VXXBXXP/S | JTP00RE-XX-XXP/S (014)         |  |
| II                  | MS27497VXXCXXP/S | JTPS00RE-XX-XXP/S              |  |
| II                  | MS27497VXXFXFP/S | JTP00RE-XX-XXP/S (023)         |  |

| Series or Accessory | MS Part No.      | Amphenol Part No.       | Description   |
|---------------------|------------------|-------------------------|---|
| I                   | MS27498EXXAXXP/S | LJT08RE-XX-XXP/S        | 90 Degree Plug, Inactive for Design                                 |
| I                   | MS27498EXXBXXP/S | LJT08RE-XX-XXP/S (014)  |   |
| II                  | MS27499EXXAXXP/S | JT02RE-XX-XXP/S         | Box Mount Receptacle  |
| II                  | MS27499EXXBXXP/S | JT02RE-XX-XXP/S (014)   |   |
| II                  | MS27499EXXCXXP/S | JTS02RE-XX-XXP/S        |   |
| II                  | MS27499EXFXFP/S  | JT02RE-XX-XXP/S (023)   |   |
| II                  | MS27500EXXAXXP/S | JT08RE-XX-XXP/S         | 90 Degree Plug, Inactive for Design                                 |
| II                  | MS27500EXXBXXP/S | JT08RE-XX-XXP/S (014)   |   |
| I                   | MS27501AXXC      | 10-421399-XX7           | Cover, Plug, with chain   |
| I                   | MS27501BXXC      | 10-421399-XX9           |   |
| I                   | MS27501FXXC      | 10-421399-XXG           |   |
| I                   | MS27502AXXC      | 10-427406-XX7           | Cover Receptacle, with chain  |
| I                   | MS27502BXXC      | 10-427406-XX9           |   |
| I                   | MS27502FXXC      | 10-427406-XXG           |   |
| II                  | MS27503YXXEXXP   | JTSIY-XX-XXP            | Solder Mount Receptacle, Hermetic Seal Inactive, use MS27503        |
| II                  | MS27504EXXCXXP/S | JTS00RE-XX-XXP/S        | Box Mount Receptacle, Inactive, use MS27499                         |
| I                   | MS27505EXXAXXP/S | LJTP02RE-XX-XXP/S (023) | Back Panel Wall Mount Receptacle                                    |
| I                   | MS27505EXXBXXP/S | LJTP02RE-XX-XXP/S (014) |   |
| I                   | MS27505EXXFXXP/S | LJTP02RE-XX-XXP/S (023) |   |
| I                   | MS27506AXX-1     | 10-436792-XX7           | Adapter, Strain Relief, Clamp Bars                                  |
| I                   | MS27506BXX-1     | 10-436792-XX9           |   |
| I                   | MS27506FXX-1     | 10-436792-XXG           |   |
| II                  | MS27506AXX-2     | 10-433992-XX7           |   |
| II                  | MS27506BXX-2     | 10-433992-XX9           |   |
| II                  | MS27506CXX-2     | 10-433992-XX5           |   |
| II                  | MS27506FXX-2     | 10-433992-XXG           |   |
| I & II              | MS27507A-XX      | 10-415693-XX7           |   |
| I & II              | MS27507B-XX      | 10-415693-XX9           |   |
| I & II              | MS27507C-XX      | 10-415693-XX5           |   |
| I & II              | MS27507F-XX      | 10-415693-XXG           |   |
| II                  | MS27508EXXAXXP/S | JTP02RE-XX-XXP/S        | Back Panel Box Mount Receptacle                                     |
| II                  | MS27508EXXBXXP/S | JTP02RE-XX-XXP/S (014)  |   |
| II                  | MS27508EXXCXXP/S | JTPS02RE-XX-XXP/S       |   |
| II                  | MS27508EXFXFP/S  | JTP02RE-XX-XXP/S (023)  |   |
| I & II              | MS27509R-XX      | 10-296943-XX            | Tool, Contact Removal and Assembly, Plastic Inactive, use M81969/14 |
| I & II              | MS27509A-XX      | 10-296940-XX            |   |
| II                  | MS27510AXXC      | 10-241801-XX7           | Cap, Plug with chain  |
| II                  | MS27510BXXC      | 10-241801-XX9           |   |
| II                  | MS27510CXXC      | 10-241801-XX5           |   |
| II                  | MS27510FXXC      | 10-241801-XXG           |   |
| II                  | MS27511AXXC      | 10-241800-XX7           | Cap, Receptacle, with chain   |
| II                  | MS27511BXXC      | 10-241800-XX9           |   |
| II                  | MS27511CXXC      | 10-241800-XX5           |   |
| II                  | MS27511FXXC      | 10-241800-XXG           |   |
| II                  | MS27511AXXR      | 10-241866-XX7           | Cap, Receptacle with wire rope                                      |
| II                  | MS27511BXXR      | 10-241866-XX9           |   |
| II                  | MS27511CXXR      | 10-241866-XX5           |   |
| II                  | MS27511FXXR      | 10-241866-XXG           |   |
| II                  | MS27510 ( )XXR   | 10-241864-              | Cap, Plug with wire rope  |
| II                  | MS27511 ( )XXN   | 10-241802-              | Cap, Receptacle, Jam Nut, with chain                                |

**MIL-DTL-38999 LJT-R/JT-R and Accessories  
Cross Reference List (Cont.)**

| Series or Accessory | MS Part No.      | Amphenol Part No.        | Description  |
|---------------------|------------------|--------------------------|--|
| II                  | MS27512-XXA      | 10-101917-XX7            | Nut, Hex   |
| II                  | MS27512-XXB      | 10-101917-XX9            |  |
| II                  | MS27512-XXC      | 10-101917-XX5            |  |
| II                  | MS27512-XXE      | 10-260548-XX             |  |
| II                  | MS27512-XXF      | 10-101917-XXG            |  |
| II                  | MS27513EXXAXXP/S | JT02RE-XX-XXP/S          | Box Mount Receptacle, Full Length Grommet                |
| II                  | MS27513EXXAXXP/S | JT02RE-XX-XXP/S (014)    |  |
| II                  | MS27513EXXCXXP/S | JTS02RE-XX-XXP/S         |  |
| II                  | MS27513EXXFXXP/S | JT02RE-XX-XXP/S (023)    |  |
| I                   | MS3186AXXW       | 10-123017-XX7            | Nut, Hex   |
| I                   |                  | 10-123017-XX9            |  |
| I                   |                  | 10-195959-XX             |  |
| I                   |                  | 10-123017-XXG            |  |
| I                   | MS27515EXXAXXP/S | LJTP00RE-XX-XXP/S        | Black Panel Wall Mount Receptacle, Inactive, Use MS27656 |
| I                   | MS27515EXXBXXP/S | LJTP00RE-XX-XXP/S (014)  |  |
| I & II              | MS81969/14-04    | 10-538988-12             | Tool, Contact Insertion/ Removal, Plastic                |
| I & II              | MS81969/14-03    | 10-538988-16             |  |
| I & II              | MS81969/14-10    | 10-538988-20             |  |
| I & II              | MS81969/14-01    | 10-538988-22D            |  |
| I                   | MS39029/59       | 21-33101-XX              | Contact, Socket, Shielded                                |
| I                   | MS39029/60       | 21-33102-XX              | Contact, Pin, Shielded                                   |
| I                   | MS27652EXXFXXP/S | LJTS00RE-XX-XXP/S (023)  | Wall Mount Receptacle Inactive, Use MS27466              |
| I                   | MS27652TXXFXXP/S | LJTS00RT-XX-XXP/S (023)  |  |
| I                   | MS27653EXXFXXP/S | LJTS06RE-XX-XXP/S (023)  | Straight Plug, Inactive, Use MS27467                     |
| I                   | MS27653TXXFXXP/S | LJTS06RT-XX-XXP/S (023)  |  |
| I                   | MS27654EXXFXXP/S | LJTPS00RE-XX-XXP/S (023) | Back Panel Wall Mount Recept. Inactive, Use MS27656      |
| I                   | MS27654TXXFXXP/S | LJTPS00RT-XX-XXP/S (023) |  |
| I                   | MS27655-XX       | 10-407035-XXH            | Contact, Socket, Inactive, Use MS27490                   |
| I                   | MS27656EXXAXXP/S | LJTPQ00RE-XX-XXP/S       | Back Panel Wall Mount Receptacle                         |
| I                   | MS27656EXXFXXP/S | LJTPQ00RE-XX-XXP/S (014) |  |
| I                   | MS27656EXXFXXP/S | LJTPQ00RE-XX-XXP/S (023) |  |

| Series or Accessory | MS Part No.      | Amphenol Part No.        | Description  |
|---------------------|------------------|--------------------------|--|
| I                   | MS27656TXXAXXP/S | LJTPQ00RT-XX-XXP/S       | Back Panel Wall Mount Receptacle                       |
| I                   | MS27656PXXBXXP/S | LJTPQ00RT-XX-XXP/S (014) |  |
| I                   | MS27656PXXFXXP/S | LJTPQ00RT-XX-XXP/S (023) |  |
| I                   | MS27656PXXAXXP/S | LJTPQ00RP-XX-XXP/S       | Back Panel Wall Mount Receptacle                       |
| I                   | MS27656PXXBXXP/S | LJTPQ00RP-XX-XXP/S (014) |  |
| I                   | MS27656PXXFXXP/S | LJTPQ00RP-XX-XXP/S (023) |  |
| I                   | MS27661EXXAXXP/S | 87-538800/74             | Straight Plug, Lanyard Release                         |
| I                   | MS27661EXXBXXP/S | 88-538800/74             |  |
| I                   | MS27661EXXFXXP/S | 91-538800/74             |  |
| I                   | MS27662EXXAXXC   | LJTB-XX-XXX              | Thru-Bulkhead Mount Receptacle                         |
| I                   | MS27662EXXBXXC   | LJTB-XX-XXX              |  |
| I                   | MS27662EXXCXXC   | LJTB-XX-XXX              |  |
| I                   | MS27662EXXFXXC   | LJTB-XX-XXX              |  |
| I & II              | MS27663AXX-1     | 10-482790-XX7            | Adapter Nut, Non-Metallic (Nylon Only)                 |
| I & II              | MS27663BXX-1     | 10-482790-XX9            |  |
| I & II              | MS27663CXX-1     | 10-482790-XX5            |  |
| I & II              | MS27663FXX-1     | 10-482790-XX6            | Adapter 90 Degree, Non-Metallic (Nylon Only)           |
| I & II              | MS27663AXX-2     | 10-482494-XX7            |  |
| I & II              | MS27663BXX-2     | 10-482494-XX9            |  |
| I & II              | MS27663CXX-2     | 10-482494-XX5            |  |
| I & II              | MS27663FXX-2     | 10-482494-XX6            |  |
| II                  | MS27664EXXAXXP/S | JTPQ00RE-XX-XXP/S        | Back Panel Wall Mount Receptacle, Inactive Use MS27497 |
| II                  | MS27664EXXBXXP/S | JTPQ00RE-XX-XXP/S (014)  |  |
| II                  | MS27664EXXCXXP/S | JTPSQ00RE-XX-XXP/S       |  |
| II                  | MS27664EXXFXXP/S | JTPQ00RE-XX-XXP/S (023)  |  |
| II                  | MS27664TXXAXXP/S | JTPQ00RT-XX-XXP/S        |  |
| II                  | MS27664TXXBXXP/S | JTPQ00RT-XX-XXP/S (014)  |  |
| II                  | MS27664TXXCXXP/S | JTPSQ00RT-XX-XXP/S       |  |
| II                  | MS27664TXXFXXP/S | JTPQ00RT-XX-XXP/S (023)  |  |
| I                   | MS27665          |                          | Rack and Panel, Cancelled                              |
|                     | MS27666          | DNS                      |  |
| II                  | MS27667EXXBXXC   | JTB-XX-XX                | Thru-Bulkhead UTZ Receptacle                           |
| II                  | MS27667EXXCXXC   | JTB-XX-XX                |  |
| II                  | MS27667EXXFXXC   | JTB-XX-XX                |  |
|                     | MS27668          | DNS                      |  |
|                     | MS27669          | DNS                      |  |
|                     | MS27670          | DNS                      |  |

**Subminiature Tri-Start**

**How to Order – Amphenol® TV, metal and Amphenol® TV26 CLUTCH-LOK®**

**Proprietary Part Number**

Amphenol® Tri-Start Connectors (metal) can be ordered by coded part number. Ordering procedure is illustrated by part number TVPS00RF-9-35P B (XXX) as shown below:

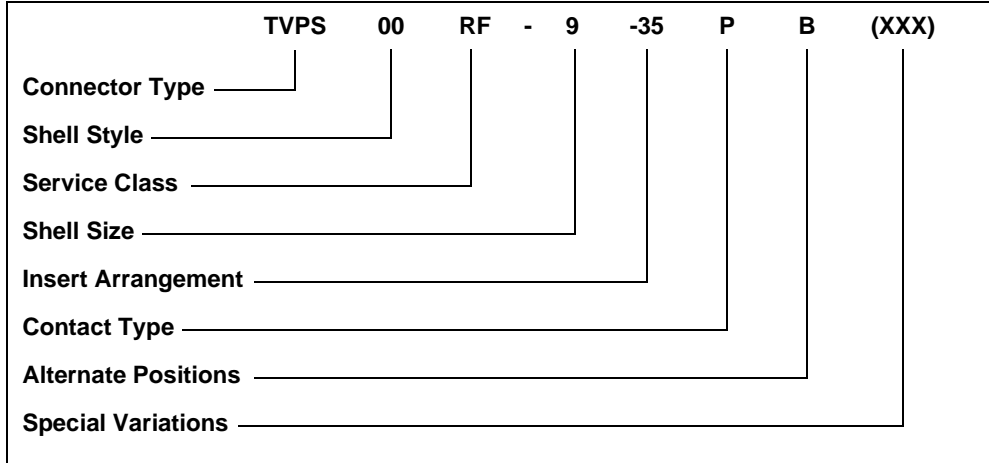

**Connector Type**

- TV designates Tri-Start Series Connector
- TVP designates back panel mounted receptacle
- TVS designates 200°C rated
- TVPS designates back panel mounted, 200°C rated receptacle

**Shell Style**

- 00 designates wall mount receptacle
- 01 designates line receptacle
- 02 designates box mount receptacle
- 06 designates straight plug
- 26 designates proprietary CLUTCH-LOK high vibration straight plug (available in service classes RK and RS only)
- 07 designates jam nut receptacle
- 09 designates flange mounted plug
- IY designates solder mounted receptacle, hermetic only
- HIY designates weld mounted receptacle, hermetic only

**Service Class**

- RX alternate finish, requires special variation suffix. Example: non-conductive, anodic coated aluminum is defined by variation suffix 005. Consult Amphenol, Sidney NY for details, options and availability of non-cadmium or nickel finishes.
- RF electroless nickel plated aluminum, optimum EMI shielding effectiveness –65dB @ 10GHz specification min., 48 hour salt spray, 200°C
- RGF\*\* electroless nickel plated ground plane aluminum, 200°C
- RGW\*\* olive drab cadmium plated ground plane aluminum, 175°C
- RK\* corrosion resistant stainless steel, firewall capability, plus 500 hour salt spray resistance, EMI –45 dB @ GHz specification min., 200°C
- RW corrosion resistant olive drab cadmium plate aluminum, 500 hour extended salt spray, EMI –50 dB @ 10 GHz specification min., 175°C
- RQF same as RF except with Quadrax contacts
- RGQF same as RGF except with Quadrax contacts
- RGQW same as RGW except with Quadrax contacts

- RQK same as RK except with Quadrax contacts and not firewall capable
- RQW same as RW except with Quadrax contacts
- Y hermetic seal, passivated stainless steel, 200°C
- RS\* (non-hermetic connectors), nickel plated stainless steel, optimum EMI shielding effectiveness –65dB @ 10 GHz specification min., 500 hour salt spray, 200°C, firewall barrier
- YN (hermetic connectors), nickel plated stainless steel, 200°C
- DN Durmalon plated, Nickel-PTFE alternative to cadmium. Corrosion resistant, 1,000 hour salt spray, EMI-50dB at 10GHz specification min., 175 degrees

**Shell Size**

MIL-DTL-38999, Sizes 9-25.

| A | B  | C  | D  | E  | F  | G  | H  | J  | MIL Shell Size       |
|---|----|----|----|----|----|----|----|----|----------------------|
| 9 | 11 | 13 | 15 | 17 | 19 | 21 | 23 | 25 | Amphenol® Shell Size |

**Insert Arrangement**

MIL-DTL-38999, see insert arrangement charts in catalog 12-C1

**Contact Type**

- P designates pin contacts
- S designates socket contacts

**Alternate Positions**

Locksmith keying - rotation of minor keys. See catalog 12-C1 "N" not required for normal position.

**Special Variations**

Consult Amphenol Aerospace, Sidney, NY for variations.

\* Coaxial arrangements are not available in these classes.  
 \*\* For more information on Coax/Triax/Twinax Ground Plane Connectors consult Amphenol Aerospace.

NOTE: Catalog 12-C1 is Amphenol's new catalog - combining 38999 Series I, II and III. These were formerly catalogs 12-090 (Series I, II) and catalog 12-092 (Series III). This combined catalog will be available 4th Qtr. 2008.

## Subminiature Tri-Start

### How to Order – D38999, TV Military, metal and MTV26 CLUTCH-LOK®

#### Military Part Number

To more easily illustrate ordering procedure by military designation, part number D38999/20F A35P B is shown as follows:

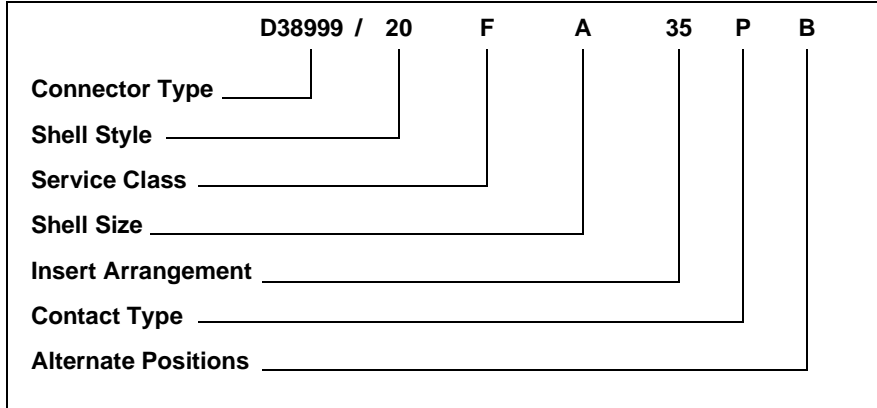

#### Connector Type

D38999/ designates MIL-DTL-38999 Series III Connector  
 MTV designates military D38999/26 CLUTCH-LOK high vibration straight plug (available in service class RK only)

#### Shell Style

- 20 designates wall mount receptacle
- 21 designates box mount receptacle, hermetic
- 23 designates jam nut receptacle, hermetic
- 24 designates jam nut receptacle
- 25 designates solder mount receptacle, hermetic
- 26 designates straight plug
- 27 designates weld mount receptacle, hermetic
- 29 designates Lanyard Release plug with pin contacts\*
- 30 designates Lanyard Release plug with socket contacts\*
- 31 designates Lanyard Release plug with MIL-STD-1760 pin contacts\*

\* For ordering Amphenol® Lanyard Release Connectors, consult catalog 12-C1. Ordering procedure for Lanyard Release Connectors includes specifying lanyard length codes and designating Style 1 or 2.

#### Protection Caps (see catalog 12-C1)

- 32 designates plug protection cap
- 33 designates receptacle protection cap

#### Service Class

- C non-conductive, anodic coated aluminum, 500 hour salt spray, 200 °C (environmental resisting)
- F electroless nickel plated aluminum, optimum EMI shielding effectiveness – 65dB @ 10GHz specification min., 48 hour salt spray, 200 °C (conductive, environmental resisting)
- G space grade, electroless nickel, 48 hour salt spray, 200 °C
- K corrosion resistant stainless steel, firewall capability, plus 500 hour salt spray resistance, EMI – 45 dB @ 10 GHz specification min., 200 °C
- L corrosion resistant steel, electro-deposited nickel, 48 hour salt spray, 200 °C

- W corrosion resistant olive drab cadmium plate aluminum, 500 hour extended salt spray, EMI – 50 dB @ 10GHz specification min., 175 °C
- Y hermetic seal, passivated stainless steel, 200 °C
- S (non-hermetic connectors), nickel plated stainless steel, optimum EMI shielding effectiveness – 65 dB @ 10 GHz specification min., 48 hour salt spray, 200 °C
- N (hermetic connectors), nickel plated stainless steel, 200 °C

#### Shell Size

MIL-DTL-38999, Size 9 – 25

| A | B  | C  | D  | E  | F  | G  | H  | J  | MIL Shell Size       |
|---|----|----|----|----|----|----|----|----|----------------------|
| 9 | 11 | 13 | 15 | 17 | 19 | 21 | 23 | 25 | Amphenol® Shell Size |

#### Insert Arrangement

MIL-DTL-38999, see catalog 12-C1

#### Contact Type

- P designates pin contacts
- S designates socket contacts
- A designates same as “P” except supplied less pin contacts
- B designates same as “S” except supplied less socket contacts (A & B designates non-standard contact applications)
- X designates eyelet contacts, hermetics only

#### Alternate Positions

Locksmith keying - rotation of minor keys. See catalog 12-C1. Use “N” for normal position

#### Special Variations

Consult Amphenol Aerospace, Sidney, NY for variations.

Amphenol® Cage Code 77820

**Subminiature Tri-Start  
How to Order –Amphenol® CTV, composite**

**Proprietary Part Number**

Amphenol® Tri-Start Composite Connectors can be ordered by coded part number. Ordering procedure is illustrated by part number CTVPS00RF-9-35PB as shown below:

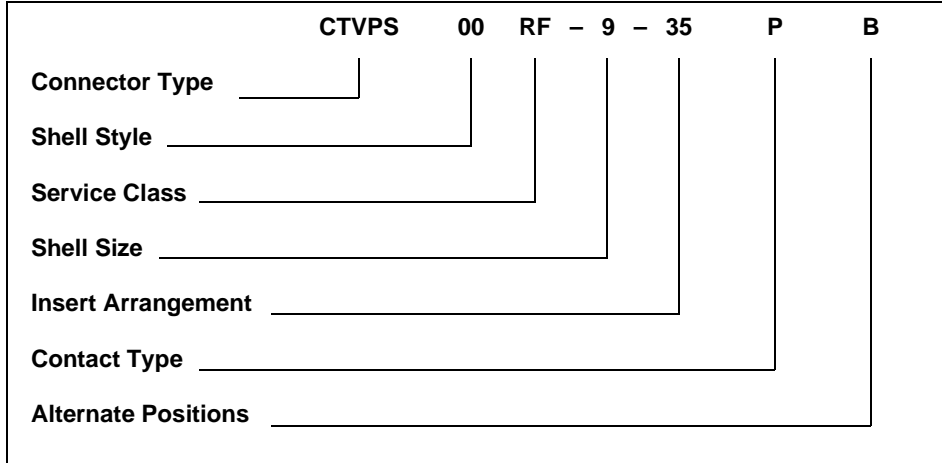

**Connector Type**

- CTV designates Tri-Start Series Connector
- CTVP designates panel mounted receptacle
- CTVS designates 200°C rated
- CTVPS designates panel mounted, 200°C rated receptacle

**Shell Style**

- 00 designates wall mount receptacle
- 01 designates line receptacle
- 02 designates box mount receptacle\*
- 06 designates straight plug
- 07 designates jam nut receptacle

**Service Class**

- RF electroless nickel plated composite, 200°C, 2000 hour salt spray
- RW olive drab cadmium plated composite, 175°C
- RGF\*\* electroless nickel plated ground plane composite, 200°C
- RGW\*\* olive drab cadmium plated ground plane composite, 175°C
- RQF same as RF composite except with Quadrax contacts
- RQW same as RW composite except with Quadrax contacts
- RGQF same as RGF composite except with Quadrax contacts
- RGQW same as RGW composite except with Quadrax contacts
- DN Durmalon plated, Nickel-PTFE alternative to Cadmium. Corrosion resistant, 1,000 hour salt spray, EMI-50dB at 10GHz specification min., 175 degrees

**Shell Size**

9 thru 25 available

**Insert Arrangement**

MIL-DTL-38999, see catalog 12-C1

**Contact Type**

- H designates 1500 cycle pin contacts
- J designates 1500 cyclesocket contacts
- P designates 500 cycle pin contacts
- S designates 500 cycle socket contacts

**Alternate Positions**

Locksmith keying - rotation of minor keys. See catalog 12-C1. "N" not required for normal position.

\* Consult Amphenol Aerospace, Sidney, NY for availability.  
\*\* For more information on Coax/Triax/Twinax Ground Plane Connectors consult Amphenol Aerospace.

Amphenol® Cage Code 77820

NOTE:Catalog 12-C1 is Amphenol's new catalog - combining 38999 Series I, II and II. These were formerly catalogs 12-090 (Series I, II) and catalog 12-092 (Series III). This combined catalog will be available 4th Qtr. 2008.

**Subminiature Tri-Start  
How to Order –D38999, CTV military, composite**

**Military Part Number**

To more easily illustrate ordering procedure of Tri-Start Composite Connectors by military designation, part number D38999/20JG35PN is shown as follows:

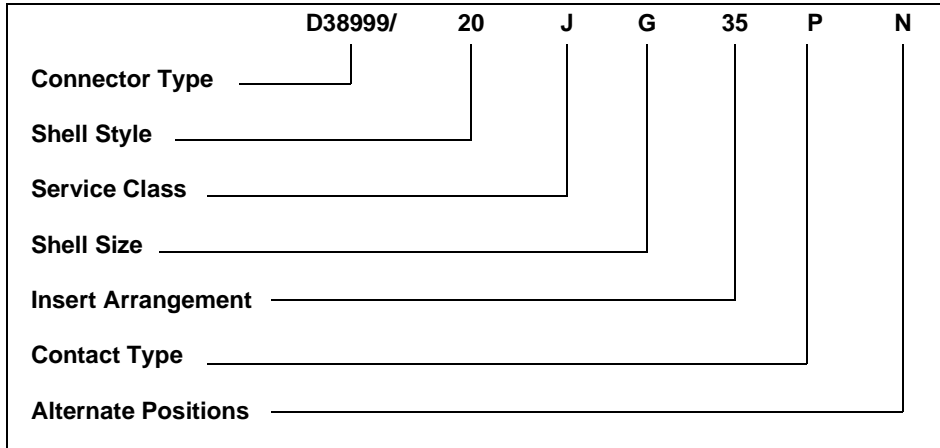

**Connector Type**

D38999/ designates MIL-DTL-38999 Series III Connector

**Shell Style**

20 designates wall mount receptacle  
 24 designates jam nut receptacle  
 26 designates straight plug  
 (Consult Amphenol Aerospace for availability of composite box mount receptacles)

**Service Class**

J olive drab cadmium plate (175°C),  
 2000 hrs. dynamic salt spray  
 M electroless nickel plate (200°C),  
 2000 hrs. dynamic salt spray

**Shell Size**

MIL-DTL-38999, Sizes 9-25

|   |    |    |    |    |    |    |    |    |                      |
|---|----|----|----|----|----|----|----|----|----------------------|
| A | B  | C  | D  | E  | F  | G  | H  | J  | MIL Shell Size       |
| 9 | 11 | 13 | 15 | 17 | 19 | 21 | 23 | 25 | Amphenol® Shell Size |

**Insert Arrangement**

MIL-DTL-38999, see catalog 12-C1

**Contact Type**

H designates 1500 cycle pin contacts  
 J designates 1500 cycle socket contacts  
 P designates 500 cycle pin contacts  
 S designates 500 cycle socket contacts  
 A designates same as "P" except supplied less pin contacts  
 B designates same as "S" except supplied less socket contacts  
 (A & B designate non-standard contact applications)

**Alternate Positions**

Locksmith keying - rotation of minor keys. See catalog 12-C1 (Use N for normal).

## Subminiature Tri-Start Specifications

### MIL-DTL-38999, Series III (TV)

- 100% scoop-proof
- High density contact arrangements
- Contact sizes 12 through 22D plus size 8, 12, 16 coax, and size 8 twinax
- Removable crimp, PCB, wire wrap, coax, triax, twinax and high speed quadax and differential twinax contacts
- Fiber optics available with MIL-PRF-29504 termini, MT ferrule termini and ARINC 801 termini
- Options include Hermetics, Filters and Thermocouples
- Self-locking, quick disconnect threaded coupling
- Corrosion resistant - shells of stainless steel or cadmium plate over nickel withstand a 500 hour salt spray exposure
- Moisture resistance - improved interfacial seal design prevents electrolytic erosion of contacts
- EMI shielding - designed to obtain metal-to-metal coupling, the TV connector provides a superior EMI shielding capability
- Vibration/Shock - operates under severe, high temperature shock and vibration testing through 200° C
- Clutch-Lok™ MIL-DTL-38999 Series III High Vibration Connector - All advantages of stainless steel/Class K firewall Tri-Start connectors plus a unique clutch design that actually tightens itself under vibration
- Firewall capability - available in stainless steel shell, Class K
- Composite Tri-Start, qualified to MIL-DTL-38999, Rev. J - offers a lightweight, corrosion resistant connector with the same high performance features as it's metal counterpart.
  - Light weight: 17% – 70% weight savings
  - Corrosion resistance: withstands 2000 hrs. of salt spray exposure
  - Durability: 1500 connector couplings
- Locksmith keying - 5 keyway polarization provides 5 alternate rotations
- Shell grounding fingers are standard on all plugs
- Triple-web grommet seal
- DOD preferred
- Available in a Fail Safe Lanyard Release plug
- See catalog 12-C1

NOTE: Catalog 12-C1 is Amphenol's new catalog - combining 38999 Series I, II and III. These were formerly catalogs 12-090 (Series I, II) and catalog 12-092 (Series III)

### CONTACT RATING

| Contact Size | Test Current |          | Maximum Millivolt Drop* |            |
|--------------|--------------|----------|-------------------------|------------|
|              | Crimp        | Hermetic | Crimp**                 | Hermetic** |
| 22D          | 5            | 3        | 73                      | 85         |
| 20           | 7.5          | 5        | 55                      | 60         |
| 16           | 13           | 10       | 49                      | 85         |
| 12           | 23           | 17       | 42                      | 85         |
| 10 (Power)   | 33           | NA       | 33                      | NA         |

\* Maximum Millivolt Drop data is determined by measuring resistance of mated contacts from end to end

\*\* When using silver plated wire

| Contact Size | Crimp Well Data |                    | Hermetic Well Data  |                 |
|--------------|-----------------|--------------------|---------------------|-----------------|
|              | Well Diameter   | Nominal Well Depth | Well Diameter       | Min. Well Depth |
| 22D          | .0345 ± .0010   | .141               | .036 +.004<br>-.000 | .094            |
| 20           | .047 ± .001     | .209               | .044 +.004<br>-.000 | .125            |
| 16           | .067 ± .001     | .209               | .078 +.004<br>-.002 | .141            |
| 12           | .100 ± .002     | .209               | .116 +.004<br>-.002 | .141            |
| 10 (Power)   | .137 ± .002     | .355               | NA                  | NA              |

### FINISH DATA

| Non-Hermetic Shell Components        |               |             |
|--------------------------------------|---------------|-------------|
| Finish                               | Service Class |             |
|                                      | Military      | Proprietary |
| Anodic Coating (Non-Conductive)      | C             | RX***       |
| Electroless Nickel                   | F             | RF          |
| Olive Drab Cadmium Plate Nickel Base | W             | RW          |
| Stainless Steel with Nickel Plate    | S             | RS          |
| Stainless Steel                      | K             | RK          |
| Olive Drab Cadmium Plate, Composite  | J             | RW          |
| Electroless Nickel Plate, Composite  | M             | RF          |
| Hermetic Connectors                  |               |             |
| Material/Finish                      | Suffix        |             |
|                                      | Military      | Proprietary |
| Stainless Steel                      | Y             | Y           |
| Stainless Steel, Nickel Plate        | N             | YN          |

\*\*\* Add suffix (005) to part number

### SERVICE RATING†

| Service Rating | Suggested Operating Voltage (Sea Level) |      | Test Voltage (Sea Level) | Test Voltage 50,000 Ft. | Test Voltage 70,000 Ft. | Test Voltage 110,000 Ft. |
|----------------|---|------|--------------------------|-------------------------|-------------------------|--------------------------|
|                | AC (RMS)                                | DC   |                          |                         |                         |                          |
| M              | 400                                     | 550  | 1300 VRMS                | 550 VRMS                | 350 VRMS                | 200 VRMS                 |
| N              | 300                                     | 450  | 1000 VRMS                | 400 VRMS                | 260 VRMS                | 200 VRMS                 |
| I              | 600                                     | 850  | 1800 VRMS                | 600 VRMS                | 400 VRMS                | 200 VRMS                 |
| II             | 900                                     | 1250 | 2300 VRMS                | 800 VRMS                | 500 VRMS                | 200 VRMS                 |

† Please note that the establishment of electrical safety factors is left entirely in the designer's hands, since he is in the best position to know what peak voltages, switching surges, transients, etc. can be expected in a particular circuit.

## Subminiature SJT Features, Part Number Breakdown

- 100% scoop-proof – Basic LJT lengths
- Basic JT mounting dimensions
- Bayonet coupling
- 5 key/keyway polarization with 4 alternate keyings
- Rear release crimp contacts
- PCB, wire wrap, twinax and coax contacts available
- High density insert patterns available
- Shell grounding fingers are an option on the plug
- Options include Hermetics, Filters and Thermocouples
- See catalog 12-091

## SJT How to Order

### PART NUMBER

To more easily illustrate ordering procedure, part number SJT00RT-18-66PA( ) is shown as follows:

|       |       |       |   |       |   |       |       |       |       |
|-------|-------|-------|---|-------|---|-------|-------|-------|-------|
| SJT   | 00    | RT    | – | 18    | – | 66    | P     | A     | ( )   |
| └───┘ | └───┘ | └───┘ |   | └───┘ |   | └───┘ | └───┘ | └───┘ | └───┘ |
| 1     | 2     | 3     |   | 4     |   | 5     | 6     | 7     | 8     |

See code below:

#### 1. Connector Type

SJT designates standard scoop-proof Junior Tri-Lock Connector

SJTS designates high temperature connector

SJTG designates plug with grounding fingers

SJTP designates back panel mounted

#### 2. Shell Style

00 designates wall mount receptacle

06 designates straight plug

07 designates jam nut receptacle

I designates solder mount receptacle – hermetic

#### 3. Service Class

“Y” for hermetic applications, fused compression glass sealed inserts. Leakage rate less than .01 micron cu. ft./hr. ( $1 \times 10^{-7}$  cc/sec.) at 15 psi differential, with interfacial seal.

“RT” for environmental applications - supplied without rear accessories. Design provides serrations on rear threads of shells.

For additional information defining complete description of service class, consult Amphenol, Sidney, NY.

#### 4. SJT shell sizes available from 8 through 24.

#### 5. – 66 designates insert arrangement

#### 6. P designates pin contacts; S for socket contacts

#### 7. A designates a rotated connector assembly (alternate keying). Other basic rotations are B, C and D. No letter required for normal, (no rotation) position

#### 8. Finish variation suffix



# SECTION V

## Cross Reference by MIL-Spec to Competitor's Part Number

### MIL-DTL-5015 (Solder Type) Typical Part No. - MS310X

| Class                            | Amphenol                            |                        | ITT Cannon          |
|----------------------------------|-------------------------------------|------------------------|---------------------|
|                                  | A, C, E, F, R                       | A, B                   | A, C, E, F, B, K, R |
| Proprietary Part No. (A.N.-M.S.) | GP, SC, SF<br>CS, SG, SB<br>SM, ACS | MS310X<br>or<br>97310X | CA310X              |
| Shell Size:                      |                                     |                        |                     |
| MS3100                           | X                                   | X                      | X                   |
| MS3101                           | X                                   | X                      | X                   |
| MS3102                           | X                                   | X                      | X                   |
| MS3103                           | X                                   | X                      | X                   |
| MS3106                           | X                                   | X                      | X                   |
| MS3107                           | see 97 Series                       | X                      | X                   |
| MS3108                           | X                                   | X                      | X                   |

Amphenol Proprietary Interates: 10-214XXX, 10-244XXX  
(Crimp types - front removal)

Amphenol Proprietary Non-Interates: (5015 Type)  
See also Heavy Duty Class "L", Amphenol QWLD (MIL-DTL-22992),  
catalog 12-052  
See also Heavy Duty QWL, catalog 12-053  
See also GT Series Reverse Bayonet Coupling, catalog 12-024

### MIL-DTL-5015 (Crimp - Front Release) Typical Part No. - MS340X

| Amphenol | S.A.E.     | Trans Tech<br>(Flight) | Cannon |
|----------|------------|------------------------|--------|
| DNS*     | MOXD, MIXD | FF                     | WFS    |

### MIL-DTL-5015 (Crimp - Rear Release) Typical Part No. - MS3450X

| Amphenol | ITT    | S.A.E. | Trans Tech | Aero Electric |
|----------|--------|--------|------------|---------------|
| 944X     | CV345X | M5X    | MS         | AE            |

### MIL-DTL-22992 Typical Part No. - MS1734X

| Amphenol  | ITT Cannon                      |
|-----------|---------------------------------|
| 10-194XXX | WLDX (shell sizes 18 & 32 only) |

### MIL-DTL-22992 Class L (Power Connector) Typical Part No. - MS9055X

| Amphenol  | General Connector |
|-----------|-------------------|
| 10-473XXX | GLCXX             |

### MIL-DTL-26500 (Crimp - Front Release) Typical Part No. - MS24266X

| Amphenol/<br>Pyle | Amphenol | Cinch  | RMS   | Aero  |
|-------------------|----------|--------|-------|-------|
| ZZ( )-            | 48-XX    | C48-XX | R071X | AE66X |

### MIL-DTL-26482 (Solder Type) Series 1 Typical Part No. - MS311X

|              | Amphenol | Souriau | Cannon | Framatome | Array | Veam |
|--------------|----------|---------|--------|-----------|-------|------|
| Type         | PT       | BT/851  | KPT    | 851-00    | PW    | VPT  |
| Shell Style: |          |         |        |           |       |      |
| MS3110       | X        | X       | X      | X         | X     | X    |
| MS3111       | X        | X       | X      | X         | X     | X    |
| MS3112       | X        | X       | X      | X         | X     | X    |
| MS3113       | X        | X       | X      |           |       | X    |
| MS3116       | X        | X       | X      | X         | X     | X    |
| MS3114       | X        | X       | X      | X         | X     | X    |

### MIL-DTL-26482 (Crimp - Front Release) Series 1 Typical Part No. - MS312X

|              | Amphenol | Burndy   | Cannon | Array |
|--------------|----------|----------|--------|-------|
| Type         | PT-SE    | LTE, LTF | KP-SE  | PWF   |
| Shell Style: |          |          |        |       |
| MS3120       | X        | X        | X      | X     |
| MS3121       | X        | X        | X      | X     |
| MS3122       | X        | X        | X      | X     |
| MS3126       | X        | X        | X      | X     |
| MS3124       | X        | X        | X      | X     |
| MS3127       | X        | X        | X      |       |
| MS3128       | X        | X        | X      |       |

Amphenol Proprietary Interates: DC, SP, BP; also PT-CE.

### MIL-DTL-26482 (Crimp - Rear Release) Series 2 Typical Part No. - MS347X

| Amphenol | Cannon | Deutsch | Aero | Corsair |
|----------|--------|---------|------|---------|
| MB1      | PV     | AFD     | AE   | CT097   |

### MIL-DTL-81511 (Crimp - Rear Release) Series I & II Typical Part No. - M81511/0X

| Amphenol |
|----------|
| 348-     |

### MIL-DTL-81511 (Crimp - Rear Release) Series III & IV Typical Part No. - M81511/4X

| Amphenol | Deutsch |
|----------|---------|
| DNS*     | B815    |

### MIL-DTL-83723 (Crimp - Rear Release) Series III Typical Part No. - M83723/71X

| Amphenol/Pyle | Amphenol/Matrix | Amphenol | Deutsch |
|---------------|-----------------|----------|---------|
| BTX/BYX       | MB3X/MT3X       | 518-     | DL60X   |

\*DNS - Do not supply

### Intermating Chart

| MIL Series            | All 5015 | All* 26482 | All 26500 | Series I 38999 | Series II 38999 | Series III 38999 | Series I 27599 | Series II 27599 | Series I 83723 | Series II 82723 | Series III 83723 | Series I & II 81511 | Series III & IV 81511 |
|-----------------------|----------|------------|-----------|----------------|-----------------|------------------|----------------|-----------------|----------------|-----------------|------------------|---------------------|-----------------------|
| All 5015              | X        |            |           |                |                 |                  |                |                 |                | X               |                  |                     |                       |
| All 26482*            |          | X          |           |                |                 |                  |                |                 | X              |                 |                  |                     |                       |
| All 26500             |          |            | X         |                |                 |                  |                |                 |                |                 | X                |                     |                       |
| Series I 38999        |          |            |           | X              |                 |                  | X              |                 |                |                 |                  |                     |                       |
| Series II 38999       |          |            |           |                | X               |                  |                | X               |                |                 |                  |                     |                       |
| Series III 38999      |          |            |           |                |                 | X                |                |                 |                |                 |                  |                     |                       |
| Series I 27599        |          |            |           | X              |                 |                  | X              |                 |                |                 |                  |                     |                       |
| Series II 27599       |          |            |           |                | X               |                  |                | X               |                |                 |                  |                     |                       |
| Series I 83723        |          | X          |           |                |                 |                  |                |                 | X              |                 |                  |                     |                       |
| Series II 83723       | X        |            |           |                |                 |                  |                |                 |                | X               |                  |                     |                       |
| Series III 83723      |          |            | X         |                |                 |                  |                |                 |                |                 |                  |                     |                       |
| Series I & II 81511   |          |            |           |                |                 |                  |                |                 |                |                 |                  | X                   | X                     |
| Series III & IV 81511 |          |            |           |                |                 |                  |                |                 |                |                 |                  | X                   | X                     |

\* Except push pull coupling

### Cross Reference by MIL-Spec to Competitor's Part No. MIL-DTL-38999 (Crimp Rear Release) Series I, II, III and IV

| Series | Amphenol | Cannon/Vecam | G & H | American Pyle-National | Deutsch | Souriau | American Micro Products |
|--------|----------|--------------|-------|------------------------|---------|---------|-------------------------|
| I      | LJT      | KJL/LTT      | -     | T1                     | DJT     | 8LT     | 3C&B                    |
| II     | JT       | KJ           | -     | -                      | DJT     | 8T      | XC7C-( )                |
| III    | TV-CTV   | KJA/VTTG3XXX | G-300 | T3                     | DTS     | 8D      | X ( )C-(                |
| IV     | -        | -            | BLXX  | -                      | DIV     | -       |                         |

| Series | Socapex | Amphenol LTD | Aero Electric | Deutsch LTD/ Dagan |
|--------|---------|--------------|---------------|--------------------|
| I      | LJT     | LJT          | AE16          | DJT                |
| II     | -       | JT           | AE27          | DTL                |
| III    | TV      | TV           | AE32          | ACT/DTS            |
| IV     | -       | -            | -             | -                  |

| Series | Herm Seal | Hi-Rel | Sealtron | Glenair |
|--------|-----------|--------|----------|---------|
| I      | 9150      | 7600   | A9703    | 23X     |
| II     | 9XXX      | 5X000  | A980X    | 23X     |
| III    | HR        | 8000   | A9903    | 23X     |
| IV     | -         | -      | -        | 23X     |

### MIL-SPEC Cross Reference Data and General Information

| MIL-Spec                             | Description  | Amphenol Proprietary Mates   | Contact Termination & Removal                    | Contact Sizes in Series (Wire Gauge)      | Coupling Method                           | Other Notes   |
|--------------------------------------|--|--|--|---|---|---|
| MIL-DTL-5015                         | Power type connectors, large contacts<br>Older series had solder contacts; newer has crimp   | CS, SM, TBF 10-72XXX, GP, SC, SF, SG, SB, FP, 10-214XXX, 10-244XXX, 10-87XXX, etc. | Solder or crimp, front or rear removal           | 16 thru 0                                 | Threaded                                  | 310X solder, 340X crimp F. R., 345X crimp R. R., GT Series Reverse Bayonet Coupling                               |
| MIL-DTL-26482<br>* Series 1 crimp    | Miniature connector. Contacts are medium size, both power and signal currents, solder or crimp   | PT, PT-SE, PT-CE, PTS-DR, BP, SP, DC   | Solder or crimp, front or rear removal           | 20, 16, 12                                | Bayonet thread, version Non-Military      | 311X solder, 312X crimp F. R. 347X crimp R. R.  |
| MIL-DTL-22992                        | Power type connector, heavy duty. MIL-C-5015 insert patterns, rugged. Solder or crimp contacts   | QWLD 10-193XXX, Class L 10-473XXX, HK - potted backshell                           | Solder for MS1734X, Crimp for Military Class "L" | 16 thru 0                                 | Threaded (quick thread), double stub      | Class L Series is for heavy power. MS9055X Class "L"  |
| MIL-DTL-83723<br>*Series I, II & III | Series I mates with MIL-C-26482, 2 Series II mates with MIL-C-5015 Series III mates with MIL-C-26500   | Refer to applicable series. BTK, BTW, BTR, BTA, BNK, BYK, BYR, BYW, BYA, BTY, BYY  | Crimp, rear removal                              | 20, 16, 12, 8, 0                          | Threaded and bayonet, depending on series | 83723/1 thru 14, 36 thru 49 Series I, 17 thru 27 -29 -30 -33 -34 -35 -50 -52 -53 Series II, 7X -8X -9X Series III |
| MIL-DTL-38999                        | Subminiature - medium and high contact density, crimp contacts. Series I - scoop-proof   | Series I, LJT-R, (Also see MIL-DTL-27599 solder)                                   | Crimp, rear removal                              | 22D, 20, 16, 12, and coax sizes 8, 12, 16 | Bayonet                                   | Intermates with Series I of MIL-DTL-27599   |
|                                      | Series II - lightweight, low profile   | Series II, JT-R, (Also see MIL-DTL-27599 solder)                                   | Crimp, rear removal                              | 22D, 20, 16, 12, and coax sizes 12, 16    | Bayonet                                   | Intermates with Series II of MIL-DTL-27599  |
|                                      | Series III - High performance, but suited for general duty   | Series III, TV-R, T3W, T3K, T3F, T3S, T3N, T3Y, Series III CTV - Composite         | Crimp, rear removal                              | 22D, 20, 16, 12, and coax sizes 8, 12, 16 | Threaded                                  | Available in Class K Firewall and Lan-yard Release Break-away   |
|                                      | Series IV Breech-Lok, expensive design, can be difficult to mate   | None   | Crimp, rear release                              | 22D, 20, 16, 12, and coax sizes 8, 12, 16 | Breech-Lok                                | Does not meet total performance requirements of Series III  |
| MIL-DTL-26500                        | Miniature connector. Contacts are medium size, both power and signal, solder or crimp  | ZZW, ZZL, ZZY, ZZB   | Crimp, front removal                             | 20, 16, 12                                | Bayonet and Threaded                      | Intermates with Series III of MIL-DTL-83723   |
| MIL-DTL-81511*                       | Subminiature - medium and high contact density, crimp contacts. Series I & II - front release contacts Series III & IV - rear release contacts | 348 Series   | Crimp, front (gang) & rear removal               | 22, 20, 16, 12                            | Bayonet                                   | M81511/0X F. R. M81511/4X R. R.   |
| MIL-DTL-27599                        | Subminiature, similar to MIL-DTL-38999 except has non-removable solder contacts. Fully mateable with MIL-DTL-38999                             | LJT-T, P - Series I LJT-A, C, P - Series II  | Solder   | 22, 20, 16                                | Bayonet                                   | Intermates with Series I and II of MIL-DTL-38999  |

\* Denotes inactive

# SECTION VI

## Qualified Products List by Connector Specification

| QPL No./Date            | Qualified Product List                       | Manufacturer   |
|-------------------------|--|--|
| QPL-5015-43<br>(6/07)   | Series I, Solder Type MS3100 Series          | Amphenol, ITT Cannon   |
|                         | Series II, Front Release Crimp MS3400 Series | ElecSys. Inc., J-Tech, TRW Cinch   |
|                         | Series III, Rear Release Crimp MS3450 Series | Amphenol/Matrix, ITT Cannon, J Tech, Aero Electric, ElecSys. Inc.  |
|                         | Accessories only*                            | Glenair, Sunbank, Electro-Adapter, Electro-Sonic Components, Raychem, Triangle Electronics   |
| QPL-26482-100<br>(4/08) | Series I, Solder MS3110 Series               | Amphenol, Array, ITT Cannon, Souriau   |
|                         | Hermetics only                               | Amphenol, ITT Cannon, Glasseal, Deutsch, Sealtron, CIA, Herm Seal  |
|                         | Series I, Crimp MS3120 Series                | Amphenol, Burndy, Cannon, Veam, Souriau, Array   |
|                         | Series II, Hermetic (MS3400) Series          | Deutsch, Glasseal, Herm Seal, Array, Sealtron  |
|                         | Series II, Crimp MS3470 Series               | Amphenol, Aero Electric, ITT Cannon, Deutsch, Corsair, Souriau   |
|                         | Accessories only*                            | Sunbank, Glenair, Array  |
| QPL-83723-66<br>(11/06) | Series I                                     | Superseded by and transferred to MIL-DTL-26482 Series II   |
|                         | Series II                                    | ITT Cannon   |
|                         | Series III                                   | Amphenol, TRW Cinch, Deutsch, Pyle-National, Aero Electric, ITT Cannon   |
|                         | Hermetics only                               | Connector Industries, Herm Seal, Sealtron  |
|                         | Accessories only*                            | Glenair, Joslyn Sunbank  |
| QPL-38999<br>(4/08)     | Series I                                     | Amphenol/Pyle, Amphenol Limited, Amphenol Socapex, Souriau, ITT Cannon, Deutsch, Aero Electric, JEC, Hi Rel  |
|                         | Series II                                    | Amphenol, ITT Cannon, Deutsch, Souriau, Aero Electric, Hi Rel  |
|                         | Hermetics only                               | Herm Seal, Sealtron, American Micro Products, Glenair  |
|                         | Series III                                   | Amphenol, Amphenol Socapex, Amphenol/Pyle, TEC, Deutsch, Souriau, ITT Cannon, Amphenol Limited, Deutsch LTD, Hi Rel, Aero Electric, American Micro Products, Glenair |
|                         | Series IV                                    | G & H Technology, Deutsch, Glenair   |
|                         | Accessories only*                            | ESC, Joslyn Sunbank  |
| QPL-22992-38<br>(1/08)  | MS17340 Series (QWLD)                        | Amphenol, ITT Cannon   |
|                         | Class "L" (MS90555) Series)                  | Amphenol, General Connector  |
| QPL-27599-14<br>(12/07) | 38999 Solder                                 | Amphenol   |
| QPL-26500-70<br>(12/05) | Miniature Cylindrical                        | Amphenol/Pyle, TRW Cinch, Aero Electric, Herm Seal, RMS  |
|                         | Accessories only*                            | Glenair, ESC   |
| QPL-81511-9<br>(12/98)  |  | Amphenol, Deutsch  |
| QPL-AS39029-2<br>(7/07) | MIL-C-26482 Series 1, Contacts               | Amphenol/Pyle, Deutsch, ITT Cannon, Tri-Star, Cinch, Veam  |
|                         | MIL-C-26482 Series 2, Contacts               | Amphenol/Pyle, Deutsch, ITT Cannon, Tri-Star, NCM  |
|                         | MIL-DTL-38999, Contacts                      | Amphenol/Pyle, ITT Cannon, Tri-Star, AMP, General Connector  |
|                         | MIL-C-22992, Class "L", Contacts             | Amphenol, General Connector  |
|                         | Other Contacts                               | May include all of the above, plus:<br>Continental Connector, AMP, J Tech. Precision Technology, Winchester and others   |

\* A General Note: Connector manufacturers also supply many of the accessories.

QPL listings change often. Manufacturers can be added or dropped at any time. This listing is current at the time of the printing of this publication (See back cover for printing date).  
Please check the current QPL when accurate information is required.

# Amphenol®/Pyle®/Matrix® Quick Product Guide

## Subminiature Cylindrical Connectors

### MIL-DTL-27599 Solder

| Military # | Proprietary # |
|------------|---------------|
| MS20026    | LJT00         |
| MS20027    | LJT01         |
| MS20028    | LJT06         |
| MS20029    | LJT07         |
| MS27334    | JT00          |
| MS27335    | JT02          |
| MS27336    | JT06          |
| MS27337    | JT07          |

### MIL-DTL-38999 Series I & II

| Military # | Proprietary # |
|------------|---------------|
| MS27466    | LJT00R        |
| MS27467    | LJT06R        |
| MS27468    | LJT07R        |
| MS27469    | LJT00Y        |
| MS27470    | LJT07Y        |
| MS27472    | JT00R         |
| MS27473    | JT06R         |
| MS27474    | JT06R         |
| MS27475    | JT00Y         |
| MS27476    | JT02Y         |
| MS27477    | JT07Y         |
| MS27478    | JTYI          |
| MS27479    | JTS00R        |
| MS27482    | JTS00Y        |
| MS27483    | JTS07Y        |
| MS27484    | JTG06R        |
| MS27496    | LJT02R        |
| MS27497    | JTPQ00R       |
| MS27499    | JT02R         |
| MS27500    | JT08R         |
| MS27503    | JTSIY         |
| MS27505    | LJTP02R       |
| MS27508    | JTP02R        |
| MS27656    | LJTPQ00R      |

### MIL-DTL-38999 Series III

|           | Metal   | Composite (CTV)     |
|-----------|---------|---------------------|
| D38999/20 | TVP00R  | CTVP00R             |
|           | TVP02R  | CTVP02R             |
| D38999/26 | TV06R   | CTV06R              |
| D38999/24 | TV07R   | CTV06R              |
|           | TV01R   | CTV01R              |
|           | TV09R   |                     |
| D38999/21 | TVPS02Y |                     |
| D38999/23 | TVS07Y  | Hermetic            |
| D38999/25 | TVSIY   |                     |
| D38999/27 |         |                     |
| D38999/29 |         | TV Failsafe Lanyard |
| D38999/30 |         | Release Plug        |
| D38999/31 |         | MIL-STD-1760 Plug   |

### High Density 38999

Inserts with 30% higher densities

### Other Proprietary 38999 Types

38999 with High speed shielded contacts  
 38999 with PCB contacts  
 38999 with High Frequency contacts  
 Clutch-Lok TV/MTV (for high vibration)  
 38999 with Flex circuitry  
 38999 Power with RADSOK® contacts  
 T-Line Series  
 Amphe-Lite Industrial  
 SJT (meets European Specifications)

### MIL-C-81511

| Military # | Proprietary # |
|------------|---------------|
| M81511/01E | 348-40E       |
| M81511/03E | 348-43E       |
| M81511/05E | 348-41E       |
| M81511/06E | 348-46E       |
| M81511/18  | 348-140       |
| M81511/21E | 348-30E       |
| M81511/23E | 348-33E       |
| M81511/25E | 348-31E       |
| M81511/26E | 348-36E       |

## Miniature Cylindrical Connectors

### MIL-DTL-26482 Series 1 Solder

| Military # | Proprietary # |
|------------|---------------|
| MS3110     | PT00          |
| MS3111     | PT01          |
| MS3112     | PT02          |
| MS3113     | PTIH          |
| MS3114     | PT07          |
| MS3114     | PT07          |
| MS3116     | PT06          |

### MIL-DTL-26482 Series 1 Crimp

| Military # | Proprietary # |
|------------|---------------|
| MS3120     | PT00SE        |
| MS3121     | PT01SE        |
| MS3122     | PT02SE        |
| MS3124     | PT07SE        |
| MS3126     | PT06SE        |
| MS23127    | MF02SE        |
| MS3128     | MF00SE        |

### MIL-DTL-26482 Series 2

|        | Amphenol part # | Matrix part # |
|--------|-----------------|---------------|
| MS3470 | PTS00DR         | MB10          |
| MS3471 | PTS01DR         | MB13          |
| MS3472 | PTPS00DR        | MB11          |
| MS3474 | PTS07DR         | MB14          |
| MS3475 | PTGS06DR        | MB16          |
| MS3476 | PTS06DR         | MB18          |

### Other Proprietary (MIL-DTL-26482 Type)

|       |            |       |
|-------|------------|-------|
| PT-CE | SP-CE      | PC-SE |
| SP    | PC         | PC-CE |
| SP-SE | Matrix MBL | RPT   |

### MIL-DTL-83723 Series III Available in Pyle or Matrix Part No.

|  |
|--|
| M83723/71 thru /78                               |
| M83723/82 thru /92                               |
| M83723/95, /96                                   |
| Matrix only: M83723/66 thru /69 Quick Disconnect |
| MB3, MT3   |

### MIL-DTL-26500

|                      |         |
|----------------------|---------|
| MS24264              | ZZY     |
| MS24265              | ZZW     |
| MS24266              | MS27613 |
| BACC45FN, FT, FS, FM |         |
| MS27614              |         |
| BACC63BP, BV         | MS27615 |
| BACC63CB, CC         |         |

### Other Proprietary Miniature Types

67 Series 165 Series

## Engine Connectors (Class K Firewall)

|                      |                     |
|----------------------|---------------------|
| D38999/20            | BACC63BR/BT         |
| D38999/24            | BACC63CN/CM         |
| D38999/26            | M83723/82-92        |
| ESC-10, 11           | M83723/95, /96, /97 |
| EN2997               | ASN-EO              |
| MIL-DTL-26500 types: |                     |
| FPK, FPL, FP5K, FYL  |                     |

## Standard/Heavy Duty Cylindrical Connectors

| MIL-DTL-5015 Solder | 97 Series Solder | 97 Series Crimp |
|---------------------|------------------|-----------------|
| MS3100              | 97-3100          | 97-4100         |
| MS3101              | 97-3101          | 97-4101         |
| MS3102              | 97-3102          | 97-4102         |
| MS3106              | 97-3106          | 97-4106         |
| MS3107              | 97-3107          | 97-4107         |
| MS3108              | 97-3108          | 97-4108         |

97 Series is UL Approved file E115497(N) and CSA Approved certification file LR69183

### Matrix MIL-DTL-5015, Series III Crimp Rear Release

|        |                       |
|--------|-----------------------|
| MS3450 | 9440                  |
| MS3451 | 9441                  |
| MS3452 | 9442                  |
| MS3454 | 9444                  |
| MS3456 | 9446                  |
| MS3459 | 9816                  |
|        | 9817 Quick Disconnect |
|        | 9818 Quick Disconnect |

### Proprietary GT Series (5015 inserts) (Reverse Bayonet)

|             |       |           |
|-------------|-------|-----------|
| GT-A        | GT-G  | GT-AGG    |
| GT-AF/F     | GT-R  | GT-PP     |
| GT-CF/CFZ   | GT-RV | GT-PC     |
| GT-CFGG     | GT-E  | GTC-M     |
| GT-LCF/LCFZ |       | Vortex GT |

### Proprietary ACA-B Series

ACA-B Reverse Bayonet (5015 inserts)

### Proprietary AC Series

AC Threaded (5015 inserts)

### Heavy Duty

#### QWLD Class L

|         |         |
|---------|---------|
| MS17343 | MS90555 |
| MS17344 | MS90556 |
| MS17345 | MS90557 |
| MS17346 | MS90558 |
| MS17347 |         |
| MS17348 |         |

Pyle Star-Line (UL, CSA listed)

Pyle Star-Line EX (certified for use in Zone 1-IIIC hazardous environment)

Pyle Star-Lok (UL, CSA listed)

Amphe-EX (ATEX and IECex rated)

RIG-Power & VFD rated inserts

### Other Proprietary Standard and Heavy Duty Types

Commercial Aircraft types:

DC Series and 10-244 Series

BT-M, BT-MA and BT-RA

Other Proprietary types:

Pre-Earth FMLB Series, 7 Series,

MS Modified types,

QWL, QWP Heavy duty types

### Amphe-Power Connectors with High Amperage RADSOK® Sockets

Amphe-Power P-Lok

Amphe-Power GT (Amphe-GTR and Power GT)

Amphe-Power 5015 (AC Series)

Amphe-BU, Amphe-Armor, Amphe-Y

RADSOK® technology is being incorporated into Mil-Aero products: Rectangulars and LRM, 38999, 5015

### RADSOK® Busbar Products

|            |           |
|------------|-----------|
| Amphe-PD   | RADLOK    |
| SurLok     | RADSERT   |
| Tru-Loc    | PGY       |
| Amphe-Base | PowerBlok |
| Amphe-Com  |           |

# Amphenol®/Pyle®/Matrix® Quick Product Guide

## EMI Filter/Transient Protection Devices

### Intermateable with/Features of

FTV - MIL-DTL-38999 Series III  
FJT - MIL-DTL-38999/27599 Series II  
FLJT - MIL-DTL 38999/27599 Series I  
FSJT - Proprietary SJT  
FBL - MIL-DTL-38999 Series IV  
FPT - MIL-DTL-26482 Series 1 & 2  
- MIL-DTL-83723 Series I

### Other EMI/Transient Protection

MOV's                      Hermetic Filters  
Diodes                     Filter Adapters  
EMP                        Filtered Plugs  
"AN" Filters

Amphenol Canada Filter Products:  
485 Series Filtered ARINC 404 & 600  
MIL-DTL-24308 Filter D-Subs  
MIL-DTL-83513 Micro D-Subs

## Fiber Optic Products

### Fiber Optic Termini:

MIL-PRF-29504/4 & /5 Multi-mode size 16  
Multi-mode, HD20  
MIL-PRF-20504/4 & /5 Single mode size 16  
90° Multi-mode size 16  
ARINC 801  
MT ferrule

### Fiber Optic Cylindrical Connectors -

**Tri-Start, MIL-DTL-38999 Series III**  
Incorporating MIL-PRF-29504 or ARINC 801 or  
MT termini

Fiber Optic Bulkhead Feed-through

### Fiber Optic Rectangular Connectors:

PCB - Brush & Fiber Optic Combinations  
LRM - Brush & Fiber Optic Combinations  
VMEP0/J0, Ruggedized VITA-46

### Fiber Optic Rack & Panel Connectors:

ARINC 600, R27 and R58 Series

### Other Fiber Optic Products

Fiber Optic Cable Systems  
MFM Family: Hermaphroditic, Duplex, Simplex  
TFOCA-II  
CTOS, CTOL, AXOS Field Deployable Lens  
ST Fiber Optics  
MIL-PRF-NGCON  
MTRJ Field  
Tactical Optical Splice  
Fiber Optic Termination Tools

## Printed Circuit Boards and Flex Circuitry

Design formats of Mentor, PADS, Cadence,  
Zuken. Panel thickness: .500"  
Panel Sizes: 24" x 54", 30" x 44", 36" x 42"  
Layer count up to 64  
Interconnect formation types: back drilled,  
dual dia., thru hole, blind, electrically isolated,  
buried, SMT  
Many other options and material choices  
Flexible and Rigid-Flex  
**For attachment to Printed circuit boards:**  
Press fit connectors  
Cylindricals with PC Tail contacts  
Universal Header Assemblies  
Flex Circuit Assemblies  
Printed Circuit Bd. Terminal Blocks  
Wiring Interface Modules

## Board Level Rectangular Connectors

### MIL-DTL-55302

#### with Bristle Brush Contacts

|            |             |
|------------|-------------|
| M55302/166 | MB ( )-( )P |
| M55302/167 | MB ( )-( )W |
| M55302/168 | PC ( )-( )P |
| M55302/169 | IO ( )-( )C |
| M55302/169 | IO ( )-( )P |
| M55302/170 | DB ( )-( )P |

### MIL-DTL-55302

#### with Crimp, Solder or PCB Contacts

|              |         |
|--------------|---------|
| M55302/67-69 | PCB90A  |
| M55302/70-71 | PCB100A |
| M55302/76-77 | PCB100B |
| M55302/74-75 | PCB100C |
| M55302/72-73 | PCB150A |

### High Density Rectangular Connectors

HDB<sup>3</sup> Mother Board/Daughter Board  
HiLinX  
Viper

### LRM Surface Mount

#### with Bristle Brush Contacts

Module and Backplane connectors with  
standard Brush contacts  
Staggered Grid - 180 contact pattern grid  
GEN-X Grid - 236 contact pattern grid  
SEM-E or custom form factors  
Air-flow inserts for wider boards  
LRM can incorporate Fiber Optics,  
RF contacts, shielded high speed contacts,  
in combinations with Brush contacts  
LRM with flex circuitry  
LRM power supply modules

### VME Rectangular Products

Ruggedized VME64-X  
Ruggedized VME P0/J0

### Backplane Connectors

#### with Tuning Fork & Blade Contacts

UHD (Ultra High Density) Connectors  
NAFI (Daughtercard/Backplane Conn.)

### Other Rectangular Connectors

I/O NAFI Series  
LMD and LMS Modules  
Amphenol AirLB SIM Modulators  
SIHD, SIAL Interconnects  
VITA -46  
Heat Sink Manufacturing  
Amphenol Canada products: R39, R58  
and SD308, CD308

## Backplane Systems

Electrical and Optical Backplane Systems that  
can incorporate:  
MIL-DTL-55302 brush contacts  
NAFI fork and blade contacts  
UHD fork and blade  
ARINC  
MIL-DTL-38999 Cylindricals  
MT Optical Ferrules

## Rack & Panel Connectors

### Rectangular Rack and Panel:

Ruggedized, Non-Floating Brush  
LPSRC, SR  
217 Series  
LE, LPX Series  
ARINC 404, ARINC 600  
R27 Series  
RFM Modular Series  
Micro D-Subs

### Cylindrical Rack and Panel:

RNJ Series

## Special Purpose Interconnection Products

### Hermetics

Available in the following series:  
MS Standard MIL-DTL-5015  
Miniature MIL-DTL-26482  
Subminiature MIL-DTL-38999, I, II, III

### Breakaway/Lanyard Release

Available in the following series:  
Fail-Safe Subminiature MIL-DTL-38999  
Twist-Pull Miniature MIL-DTL-26482  
Quick Disconnect Matrix MIL-DTL-83723  
Quick Disconnect Matrix MIL-DTL-5015  
Stores Management Type II, Rail Launch  
1760 Weapons Release  
Gatelink Breakaway

### Battlefield Interconnects & Cables

Stinger Missile types  
EMC Protected & Over-molded Cable  
Singcars, Bowman Program Connectors  
Wind Corrected Munitions Dispenser

### Rail Mass Transit/Industrial Interconnects & Cables

Freight-Mate Cable Assemblies  
Trans-Power & 27 Pole Train-Line  
Over-molded Cable available with any  
Amphenol cylindrical industrial connector

### Data Bus Products

Can Couplers, Box Couplers  
ARINC 629 Current Mode Couplers  
Wire Integrated Connectors (W.I.C.s)  
711 Data Bus

### Other Special Purpose Products

RJ Field, USB Field, MTRJ Field, EZ Field  
Amphenol Nexus Technologies Products  
for Audio Frequency Protection  
SV Microwave Connectors  
Aquacon Immersible  
Pyle Pon Series Indicator Lights  
WFRS Interlocked Safety Switches  
Astronaut Zero-G Connectors  
PMAT (ARINC 644)  
Geophysical Miniatures  
SCE and Mini SCE Push Pull  
PPM Push-Pull  
Shorting Plugs  
Micro-Miniature Connectors  
ECTA 133, ECTA 544  
Quick Connection Modules  
1900 Rectangulars  
AT Series Circular J1939 Diagnostic.

## Contacts and Accessories

Crimp M39029, Thermocouple, Wire wrap,  
Coaxial, Twinax, Triax, Quadax and  
Differential Twinax Shielded Contacts  
Bristle Brush Contacts for Rectangulars  
Fork & Blade Contacts for Rectangulars  
Fiber Optic Termini  
RADSOX® Contacts for High Amperage  
High Frequency Contacts with "Float  
Mount Technology  
AT Series Contacts  
M85049 Accessories  
Backshells  
Industrial Cord Grips and Cable Glands  
Pipe & Cable Supports  
Relay Sockets and Junction Modules

We invite you to visit our websites where you  
can find product catalogs that can be down-  
loaded and printed. Catalogs will be added  
and updated on an on-going basis.

# SECTION VII

## Know the Language

### Common terms you should know

(listed alphabetically)

- **Accessories** - Mechanical devices, such as cable added to connector shells and other such hardware that are attachable to connectors to make up the total connector configuration; while providing wire support and/or wire sealing
- **Bayonet Coupling** - A non-threaded, ramp type of coupling
- **Cable Assembly** - A cable with plugs or connectors on each end
- **Configuration** - Arrangement of contacts in a multiple-contact connector
- **Contacts** - Mechanical component to which electrical engagement is accomplished
- **Contact Size - (Also known as Wire Gauge)** - the largest wire that can be used with a specific contact
- **Contact Spacing** - The distance between the center-lines of adjacent contact areas.
- **Coupling Nut** - Outer threaded or grooved ring which holds mated pair together
- **Crimp Contact** - A contact to which wire is joined by mechanical squeeze
- **EMI or RFI Backshell** - A type of accessory to terminate wire shielding
- **Environmentally Sealed** - Connector provided with gaskets, seals, potting or other devices to keep out moisture, dirt, air or dust that might reduce its performance
- **Extraction/Removal Tool** - A handheld tool used for removing a contact from a connector.
- **Fiber Optic Termini** - Comparable to electrical pin and socket contacts, except they transmit data optically through fibers instead of electrically through wires.
- **Gland** - Resilient ring in rear accessory, provides seal on jacketed cable
- **Grounding Fingers** - A metal strap around plug shell for positive shell-to-shell conductivity/shielding
- **Grommet** - Resilient part at back of insert (attached or separate); gives wire moisture seal
- **Hermetic** - A connector with fused glass insert for air tightness



### Connector:

A device providing electrical or signal connection. It consists of a plug and receptacle.

- **Insert** - The dielectric or insulating inner core, holds contacts
- **Insert Arrangement** - The number, spacing and arrangement of contacts in a connector
- **Insertion Tool** - A small, handheld tool used to insert contacts into a connector
- **Interfacial Seal** - A resilient part on the face of pin inserts which provides moisture seal.
- **Jam Nut** - Hex nut that holds receptacle to a panel
- **Mating Pair** - Two connectors that couple together. Shell size insert arrangement and rotation must be compatible
- **Mating/Unmating Forces** - Torque required to couple/uncouple a mating pair of connectors or contacts
- **“O” Ring** - Doughnut-shaped ring of rubber used as a seal around the mating insulator interface of cylindrical connectors
- **Pin Contact** - Male half of a mated pair of contacts\*
- **Plating** - The metal finish applied to contacts and or shell components (protective) to resist corrosion and wear
- **Plug** - The cable/coupling half of a mating pair
- **Potting Boot** - A type of accessory which forms a mold for potting compound
- **Rear Termination** - An accessory which threads to back of shell
- **Receptacle** - The panel/receiving half of a mating pair
- **Sealing Plug** - Plastic type slug, placed in unused grommet holes to seal
- **Service Rating (Also known as Current Rating)** - The maximum voltage or current that a connector is designed to carry continuously.
- **Shell** - Houses insert and contacts
- **Socket Contact** - Female half of a mated pair of contacts
- **Solder Contact** - A contact to which wire is joined by soldering. Has a cup, hollow cylinder, eyelet or hook to accept a wire for conventional soldered termination.
- **Strain Relief (Also known as Cable Clamp)** - A type of accessory which clamps wires for support

\*Note: Male half always goes into female.

# SECTION VII

## Know the Language - Other Interconnection Product Terms

- **Alternate Rotations** - In cylindrical connectors: Rotation of either an insert or designated key/keyway locations (Alternate Keying) in a connector shell to a different angle than normal position. Allows for variations of mating two halves of cylindrical connectors.
- **Anodize** - Formation of a protective, insulating oxide layer on metal bay electrolytic action.
- **Arc Resistance** - The characteristic of insulating materials to resist carbonization (also known as tracking) of the material surface between electrodes resulting from voltage breakdown.
- **Attenuation** - (this term is used in Filters) The ratio of the input to output power levels in a network (transmission line) when it is excited by a matched source and terminated in a matched load.
- **Back-mounted** - When a connector is mounted from the inside of a panel or box with its mounting flanges inside the equipment.
- **Circuit** - A complete path or electron flow from a negative terminal of voltage source through a conductor and back to the positive terminal.
- **Closed Entry Socket Contacts** - A female contact designed to prevent the entry of a pin or probing device having a cross-sectional dimension greater than the mating pin.
- **Coaxial Cable** - A high-bandwidth cable consisting of two concentric cylindrical conductors with a common axis that is used for high speed data communication and video signals.
- **Compliant Contact** - A press-fit type contact used to attach to a printed circuit board. Has an eyelet end.
- **Conductivity** - The ability of a material to conduct electric current, expressed in terms of the current per unit of applied voltage. It is reciprocal of resistivity.
- **Contact Durability** - Endurance measured by the number of insertion and withdrawal cycles that a connector withstands remaining within its specified performance level.
- **Contact Engaging and Separating Force** - Force needed to either engage or separate pins and sockets when they are out of connector inserts. Values are generally established for maximum and minimum forces.
- **Contact Resistance** - Maximum permitted electrical resistance of pin and socket contacts when assembled in a connector under typical service use.
- **Contact Retention** - The minimum axial load in either direction that a contact must withstand while remaining firmly fixed in its normal position within the connector insert or housing.
- **Continuity** - A continuous path for the flow of current in an electrical circuit.
- **Corrosion** - The destruction of the surface of a metal by chemical reaction.
- **Coupling Torque** - Force required to rotate a coupling ring or jackscrew when engaging a mating pair of connectors.
- **Diallyl Phthalate (DAP)** - (Blue insert in 97 Series) A thermo-setting plastic that offers outstanding dimensional stability and resistance to most chemicals and chemical compounds.
- **Dielectric** - Any insulating medium that intervenes between two conductors.

- **Dielectric Withstanding Voltage** - Maximum potential gradient that a dielectric material can withstand without failure.
- **Discontinuity** - A broken connection or the loss of a specific connection characteristic.
- **Edge Connector** - One piece receptacle, containing female contacts designed to receive the edge of a printed circuit board and interconnect on which the male contacts are etched or printed. The connector may contain either a single or double row of female contacts.
- **Edgeboard Connector** - A connector that mates with printed wiring leads running to edge of a PC board.
- **Feed-through** - A conductor that connects patterns on opposite sides of a PC board. Also called interfacial connection.
- **Fiber Optics** - A data transmission medium consisting of glass fibers. Light-emitting diodes send light through the fiber to a detector, which then converts the light back into electrical signals.
- **First Article** - A sample part or assembly manufactured prior to the start of production for the purpose of assuring that the manufacturer is capable of manufacturing a product that will meet the requirements.
- **Front-mounted** - A connector is front-mounted when it is attached to the outside or mating side of a panel. (Can only be installed or removed from the outside of the equipment).
- **Front Release Contacts** - Connector contacts are released from the front side of the connector and then removed from the back wire side of the connector. The removal tool engages the front portion of the contact and pushes it out the back where it is removed by hand.
- **Harsh or Hostile Environment Connector** - A connector designed and engineered for operation in hostile environment conditions, such as extreme high temperatures of 677°C (1,250°F), extreme low temperatures of absolute zero and severe water tight conditions.
- **Header** - A feed through device that introduces a conductive path through an insulating plate.
- **Hermaphroditic Connector** - Interconnecting device in which both mating parts are identical at their mating surfaces. (Also called Sexless Connector)
- **Hermaphroditic Contact** - A contact in which both mating elements are precisely alike at their mating face.
- **Input/Output Connector** - A mating pair of connectors used to carry signals into and out of a panel-mounted subsystem. An example is connector pair that interconnects the individual back panels in a large array of panels.
- **Insert Retention** - Axial load in either direction that an insert must withstand without being dislocated from its normal position in the connector shell.
- **Insertion Force** - The effort, usually measured in ounces, required to engage mating components.
- **Interchangeable** - Characteristic of connectors in which one manufacturer's connector can be replaced by the connector of another manufacturer and provide the same function in the same panel space as the connector it is replacing.
- **Intermateable** - Characteristic of connectors in which a connector half manufactured by one connector will mate directly with a connector half manufactured by a different company



# SECTION VII

## Know the Language - Other Interconnection Product Terms

- **.Keying** - Mechanical arrangement of guide pins and sockets, keying plugs, contacts, bosses, slots, keyways, inserts or grooves in a connector housing, shell or insert that allows connectors of the same size and type to be lined up without the danger of making a wrong connection.
- **Lanyard** - A device attached to certain connectors that permit uncoupling and separation of connector halves by a pull on a wire or cable.
- **Life Cycle** - A test that indicates the time span before failure; the test occurs in a controlled, usually accelerated, environment.
- **Mass Termination** - Method of termination in which terminals that pierce flat cable insulation without stripping to cold flow mate with conductors and form a metal-to-metal joint.
- **Motherboard** - A printed board used for interconnecting arrays of plug-in electronic modules.
- **Operating Temperature** - Maximum internal temperature-resistant capabilities of a connector in continuous service.
- **Outgassing** - De-aeration or other gaseous emission from a printed board assembly (printed board, component of connector) when exposed to a reduced pressure or heat, or both.
- **Panel-mount** - Fixing a connector half to a board, panel or frame. Usually, the female portion of the connector is mounted, and the male half is the removable portion.
- **Plated Through-Hole** - A hole-formed deposition of metal on the sides of the hole and on both sides of the base to provide electrical connection from the conductive pattern on one side to that on the opposite side of the PC board.
- **Poke-Home Contact** - Term applied to a male or female contact to which a wire has been permanently affixed prior to the assembly of the contact into the insert.
- **Positioner** - Device attached to the crimping tool to position conductor barrels between the indentors.
- **Potting** - Sealing of a component (for example the cable end of a multiple contact connector) with a plastic compound or material to exclude moisture, prevent short circuits and provide strain relief.
- **Pre-tinned** - Solder applied to an electrical component prior to soldering.
- **Pre-tinned Solder Cup** - Solder cups with inner surfaces that have been pre-coated with a small amount of tin lead solder or RoHs approved solder.
- **Press-fit Contact** - Either a solid pin or a pin having a compliant member that makes an interference connection with a through-hole on a PC board. The pressure developed between interconnecting surfaces is sufficient to provide gas-tight electrical reliability without the use of solder.
- **Qualified Products List (QPL)** - A list of commercial products that have been pretested and found to meet the requirements of a specification, especially government specifications.
- **Quick-disconnect Coupling** - A design feature, apparent in the quick-disconnect connector; it permits relatively rapid joining and separation.
- **RADSOK® Contact\*** - A unique socket contact design with a stamped and formed twisted inner grid. Socket cylinder within the female contact has several equally spaced longitudinal beams twisted into a hyperbolic shape. As male pin is inserted, axial members in the female half deflect, imparting high current flow across the connections.
- **Ramp** - The sloped channel that accepts the detent pin in a bayonet connector.
- **Rear Release Contacts** - Connector contacts are released and removed from the rear (wire side) of the connector. The removal tool engages the contact from the rear and pulls the contact out of the connector contact retainer.
- **Rear Seal** - Design feature that provides an environmental seal at the rear of plug or receptacle.
- **Removable Contact** - A contact that can be mechanically joined to or removed from an insert. Usually, special tools are required to lock the contact in place or remove it for repair or replacement.
- **RoHS (Restrictions of Hazardous Substances)** - The RoHS Directive bans the placing on the EU market of new electrical and electronic equipment containing more than agreed levels of lead, cadmium, mercury, hexavalent chromium, polybrominated biphenyl (PBB) and polybrominated diphenyl ether (PBDE) flame retardants.
- **Scoop Proof** - Design feature whereby exposed contacts of a connector cannot be touched or damaged by any portion of the mating connector.
- **Serrations** - Small grooves or indentations within a terminal wire barrel that increase the tensile strength and electrical conductivity of the crimped termination.
- **Soldering** - Process of joining metallic surfaces with solder, without the melting of the base metals. Soldering is an economical, versatile and fast termination method. A soldered connection has metallic continuity and excellent long term reliability.
- **Splice Connector** - A joint connecting conductors with good mechanical strength and good conductivity; a terminal that permanently joins two or more wires.
- **Surface Mounting** - The electrical connection of components to the surface of a conductive pattern without utilizing component holes.
- **Thermal Shock** - The effect of heat or cold applied to a material at such a rate that non-uniform thermal expansion or contraction occur. In connectors, the effect can cause inserts and other insulation materials to pull away from metal parts.
- **Thermocouple Contact** - A contact of special material used in connectors employed in thermocouple applications. Materials often used are iron, constantan, copper, chromel and alumel.
- **Tuning Fork Contact** - U-shaped female contact that resembles a tuning fork. It can be stamped or formed.
- **Umbilical Connector** - A connector used to connect cables to a rocket or missile prior to launching, and which is removed from the missile at the time of launching.
- **Wire-Wrapped Connection (Also known as Solderless Wrap)** - A solderless connection made by wrapping bare wire around a square or rectangular terminal with a power or hand tool.

# SECTION VII, cont.

## Basic Questions to Determine Connector Requirements

- **How many conductors (wires) and what are the wire gauges (size)?**

Smallest contact sizes available by Military Specifications:

MIL-DTL-5015 - size 16  
MIL-DTL-22992 - size 16  
MIL-DTL-26482 - size 20  
MIL-DTL-38999 - size 22D

- **What's your working voltage requirement?**

See catalog insert arrangement table  
Catalog 12-024 ....GT Reverse Bayonet  
Catalog 12-020 ....MIL-DTL-5015  
Catalog 12-026 ....MIL-DTL-5015 Matrix  
Catalog 12-052 ....MIL-DTL-22992 Class L, QWLD  
Catalog 12-053 ....MIL-DTL-22992 QWL  
Catalog 12-070 ....MIL-DTL-26482, Series 1  
Catalog 12-071 ....MIL-DTL-26482, Series 2  
Catalog MS-102...MIL-DTL-83723, Series III Pyle  
Catalog 12-073 ....MIL-DTL-83723, Series III Matrix  
Catalog 12-090\*...MIL-DTL-38999, Series I, II  
Catalog 12-092\*...MIL-DTL-38999, Series III

- **Are you using your connector in a benign environment or a harsh environment?**

Harsh environment - will need gaskets, grommets and/or glands for environmental sealing

- **Do you want to Solder or Crimp your wires?**

- **Are you going cable to cable or cable to panel?**

Cable plug to Cable receptacle use:  
– Straight plug with Inline cable receptacle  
– 90° Plug with Inline cable receptacle

Cable plug to Panel receptacle use:  
– Straight plug with either a wall mount receptacle, box mount receptacle, or jam nut receptacle  
– 90° plug with either a wall mount receptacle, box mount receptacle, or jam nut receptacle

- **What's your cable outer diameter (OD)? Or are you using discrete wires?**

- **Do you have any material restrictions?**

– RoHS requirement  
– Stainless steel  
– Aluminum  
– Neoprene  
– Silicon  
– Viton

- **What type of plating or finish is preferred?**

Common platings or finishes:

– Olive drab cadmium  
– Nickel  
– Black zinc alloy  
– Electroless nickel  
– Anodic coating

- **Will you need accessories?**

– Cable clamp  
– Bushing  
– Protection caps (metal or plastic)  
– Dummy receptacle

- **Are you using an electrical or signal connector?**

### POWER

MIL-DTL-5015 and Amphenol GT Reverse Bayonet  
– Standard contacts or (High Amperage) RADSOK®  
MIL-DTL-22992  
MIL-DTL-26482  
MIL-DTL-38999 Series I, II, III

Hermetic

MIL-DTL-26482  
MIL-DTL-83723  
MIL-DTL-38999 Series I, II, III

### SIGNAL

MIL-DTL-5015  
– High Frequency contacts  
MIL-DTL-22992  
– High Frequency contacts  
MIL-DTL-38999, Series I, II, III  
– High Frequency contacts  
– Fiber Optics  
Brush Technology  
– Rectangular PCB  
– LRM  
– Fiber Optics

Filter

MIL-DTL-38999 Series I, II, III  
MIL-DTL-26482

Hermetic

MIL-DTL-26482  
MIL-DTL-83723  
MIL-DTL-38999 Series I, II, III

\* Catalog 12-C1 combined catalog for 38999 Series I, II and III Connectors will replace catalog 12-090 (Series I, II) and catalog 12-092 (Series III). Consult Amphenol Aerospace for the availability of this new catalog.

NOTE: Socket contacts are to be used in the connector feeding the power

NOTE: Not all connectors are limited to solely either power or signal. Many connectors can perform both functions.

# SECTION VII, cont.

## What do you need to Sell?

### ✓ A Basic Product Knowledge

- Why connectors are needed
- Nomenclature (component parts)
- Typical terms or descriptive words
- Pertinent references to MIL-Spec
- Cross reference Amphenol P/N to MIL P/N

### ✓ A Catalog

- Know how it is organized
- Keep it current
- Add your own notes for reference

### ✓ Know Our Websites

[www.amphenol-aerospace.com](http://www.amphenol-aerospace.com)

[www.amphenol-industrial.com](http://www.amphenol-industrial.com)

- Quickly navigate on-line to -
  - Connector Catalogs
  - Service Instructions
  - Your Contact Information
  - Markets Served
- Connector Basics has this brochure and other valuable basic connector information
- Amphenol One for Distributor Information and Latest Product News

### ✓ Know Your Organization and Ours

- Who has pricing & delivery data
- Who has technical data
- Who can expedite
- Who can negotiate
- A back up for each of the above

### ✓ Know Yourself and Your Competitors

- What is negotiable at your account
- What are your strong points
- What are your weak points
- What are your protection points
- Who is your competition

### ✓ Know Your Customers

- What are their Needs?
- Company Needs – Personal Needs

### ✓ Learn to Listen (and to See)

- What are they saying?
- What do they mean?
  - How they say it may mean more than what they say
  - What you both see may say more than conversation

### ✓ Each account is unique

- Don't use a carbon copy approach
- Let your customers know you see them that way

### ✓ Take time to know the people you deal with

- Both at your account and your facility
- Manage your time and territory like assets
- If business or potential isn't there, maybe you shouldn't be

## Conclusion

The data in this booklet was designed to provide you with basic information on Amphenol connector products.

In order to effectively sell, it is important to remember that knowing your customer and your product go hand in hand. The sale begins with you!

We have a great line, you can sell on the quality that it is. Don't promise more than you can deliver, simply tell it like it is. You may lose some sales, but your credibility will grow.



## X-ON Electronics

Largest Supplier of Electrical and Electronic Components

*Click to view similar products for [Circular MIL Spec Connector](#) category:*

*Click to view products by [Amphenol](#) manufacturer:*

Other Similar products are found below :

[0025-262-542](#) [0025-264-3014](#) [58-570121-04S](#) [0134-202-1200](#) [0134-207-1206](#) [0134-207-1800](#) [0134-207-2207](#) [0134-213-0806](#) [0134-213-1007](#) [0134-213-1009](#) [0134-213-1208](#) [0134-213-1800](#) [0134-213-2209](#) [0025-258-000](#) [015-9516-002](#) [60-042722-19P](#) [0114-201-1278](#) [602GB06EG24-61SN](#) [0134-201-1207](#) [0134-201-1806](#) [0134-201-2006](#) [0134-201-2007](#) [0134-201-2010](#) [0134-202-1400](#) [0134-207-0809](#) [0134-207-1208](#) [0134-207-2009](#) [0134-213-1006](#) [6104-207-2302](#) [6104-208-1902](#) [6131-202-19149P](#) [6131-204-21149P](#) [6131-207-13149P](#) [6131-208-13149P](#) [6131-209-17149P](#) [6131-210-11149P](#) [6131-211-19149P](#) [6131-216-19149P](#) [6131-220-25149P](#) [6131-259-11149P](#) [6131-259-21149P](#) [6131-259-23149P](#) [6131-263-19149P](#) [6131-265-17149P](#) [6131-265-19149P](#) [CS3102A-20-15P](#) [CS3102A-20-15S](#) [CS3102C18-4P-472](#) [CS3106A-20-29P](#) [CS3106A-20-74P](#)