

*So, you Want to Know Connectors . . . .*

## Amphenol's REFERENCE GUIDE to Cylindrical Connectors

*Learn the Amphenol Connector Language . . .*



L-1102-7

Printed 8/2008

# Amphenol

[www.amphenol-aerospace.com](http://www.amphenol-aerospace.com)  
[www.amphenol-industrial.com](http://www.amphenol-industrial.com)

This booklet is intended to be used as a ready reference to typical standard, miniature and subminiature cylindrical connector part numbers and terminology. Reading its brief pages will not make you a connector expert, but should guide you in becoming familiar with the product, in order to better serve our customers.

AAO, Amphenol Aerospace division of Amphenol Corporation, is the leading manufacture of military aerospace interconnect products in the world. Brand names include Amphenol® and Pyle-National® and Matrix®.

AIO, Amphenol Industrial division of Amphenol Corporation, is a worldwide leader in the manufacture of industrial and powerbus interconnect products. Brand names include Amphenol® and Pyle-National®.

Note: Many of the connector products in this brochure were formerly known as "Bendix" products. These products are now manufactured and sold under the Amphenol® brand name. The name "Amphenol" will replace the name "Bendix" on products and literature in the future.

Amphenol operates a quality system that is third-party certified to ISO9001:2000 and AS9100.

For more information and for Amphenol catalogs online go to: [www.amphenol-aerospace.com](http://www.amphenol-aerospace.com) or [www.amphenol-industrial.com](http://www.amphenol-industrial.com).

Amphenol Corporation  
 Amphenol Aerospace and  
 Amphenol Industrial Operations  
 40-60 Delaware Avenue  
 Sidney, New York 13838-1395  
 Phone: 800-678-0141 or 607-563-5011  
 Fax: 607-563-5157

## Contents

<b>SECTION I</b>	
Nomenclature: Cylindrical Connectors .....	1-3
Basic Components	
<b>SECTION II</b>	
Major MIL-Specifications by Type	
Standard, MIL-DTL-5015	
Amphenol 97 Series	
Heavy Duty, MIL-DTL-22992	
Proprietary Variations .....	4-5
MIL-DTL-5015 and 97 Series Part Number Breakdown	
MIL-DTL-22992 Part Number Breakdown	
<b>SECTION III</b>	
Major MIL-Specifications by Type	
Miniature, MIL-DTL-26482 .....	6-10
MIL-DTL-26482 Part Number Breakdown	
Miniature Crimp, Solder Part Number Breakdown	
<b>SECTION IV</b>	
Major MIL-Specifications by Type	
Subminiature, MIL-DTL-38999, MIL-DTL-27599 .....	11-22
Subminiature – JT/LJT, Tri-Start, SJT Features	
JT/LJT Part Number Breakdown and Specifications	
LJT-R/JT-R and Accessories Cross Reference List	
Tri-Start Series III Part Number Breakdown (metal, composite and Clutch-Lok)	
Tri-Start Specifications	
SJT Part Number Breakdown	
<b>SECTION V</b>	
Cross Reference by MIL-Spec to Competitor's and Amphenol Part Numbers .....	23-25
Intermating Chart	
<b>SECTION VI</b>	
Qualified Products List by Connector	
Specification .....	26
Amphenol®/Pyle®/Matrix® Quick Product Guide.....	27-28
<b>SECTION VII</b>	
Know the Language .....	29-31
Basic Questions to Determine Connector Requirements .....	32
What Do You Need to Sell.....	Inside Back Cover
Checklist	
Conclusion	

NOTE: MIL-DTL-5015 supersedes MIL-C-5015  
 MIL-DTL-22992 supersedes MIL-C-22992  
 MIL-DTL-26482 supersedes MIL-C-26482  
 MIL-DTL-38999 supersedes MIL-C-38999  
 These MIL-spec numbers will be updated in catalogs as they are printed in the future.

# SECTION I

## Nomenclature: Cylindrical Connectors

### Basic Components

1. Shell (Houses Inserts & Contacts)
2. Insert (Dielectric Contact Insulator) Pin or Socket
3. Contact (Wire End Termination) (Electrical Engagement)
4. Coupling Nut
5. Accessories (Wire Seals, Cable Seals, Wire Support, etc.)

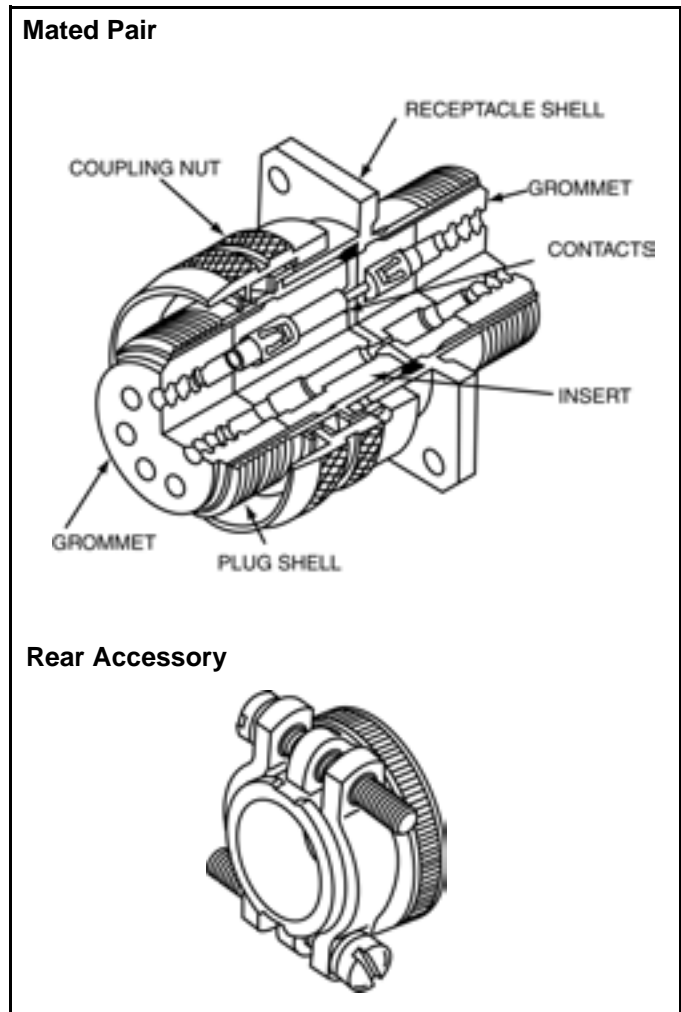
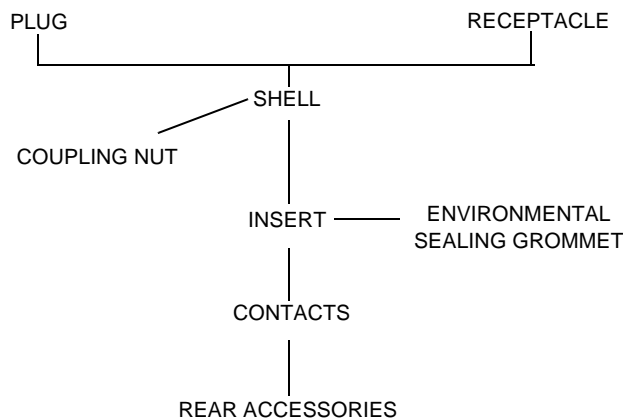

### Shell Styles

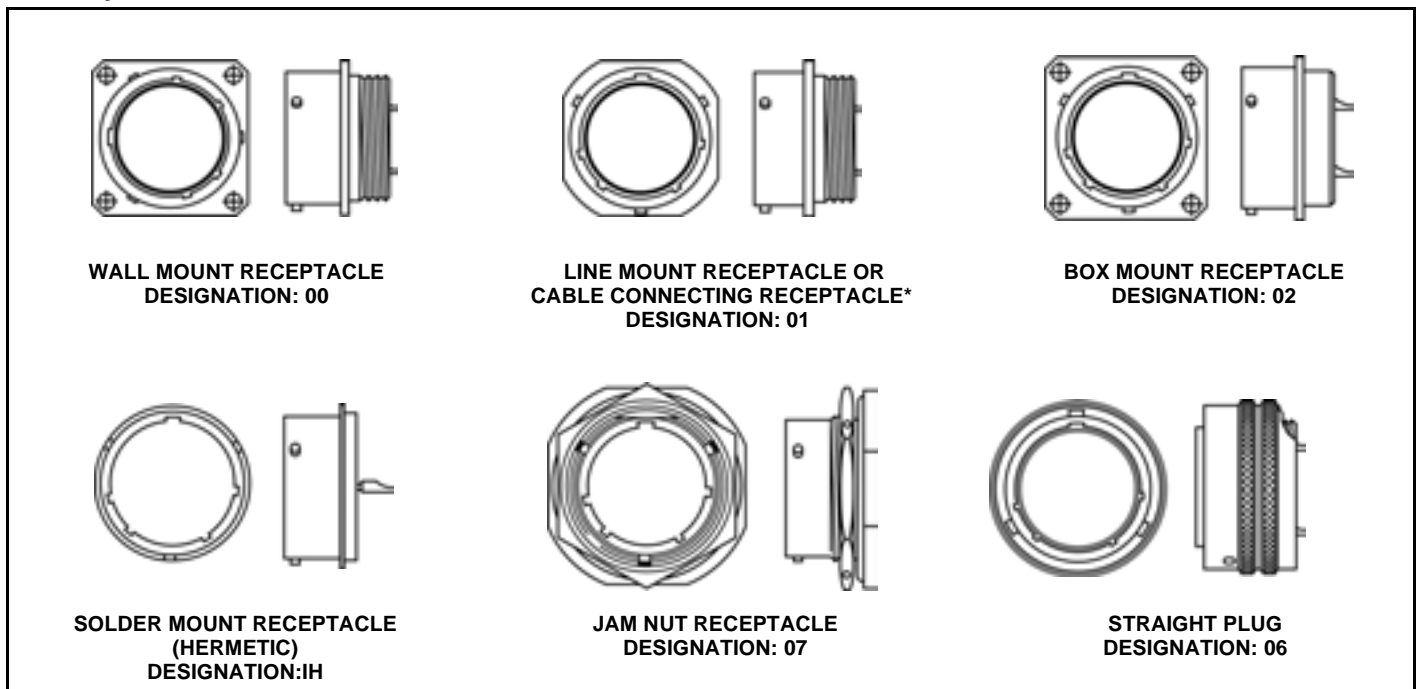

\* This connector style is sometimes referred to as a cable connecting "plug." It does, however, mate with either a straight or 90 degree plug.

## Nomenclature: Cylindrical Connectors and Contacts

### Shell Styles (Cont'd.)

#### Coupling

Threaded, Bayonet

#### Shell Sizes (Typical MIL-DTL-5015)

8S, 10S, 10SL, 12S, 12,  
14S, 14, 16S, 16, 18  
20, 22, 24, 28, 32, 36, 40, 44, 48

"S" designates short shell and short contacts

Shell size denotes mating thread diameter in 16ths of an inch. For example, a size 8 shell denotes 8/16 of an inch with a .5000-28 UNEF thread.

### Style Designation (PT)

PLUG	SHELL STYLES
06	Straight
08	Angle
09	Flange Mount Receptacle
05	Straight, Less Rear Accessory
RECEPTACLE	SHELL STYLES
00	Wall Mount
01	Cable Connecting or Line Mount Receptacle
02	Box Mount
03	Wall Mount, Less Rear Accessory
04	Line Mount, Less Rear Accessory
07	Jam Nut
IH	Solder Mount Hermetic

### Inserts

Insert  
(Pin or Socket)

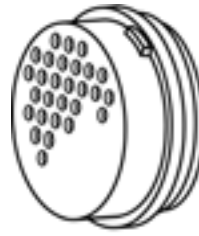

Insert &  
Grommet Assy.

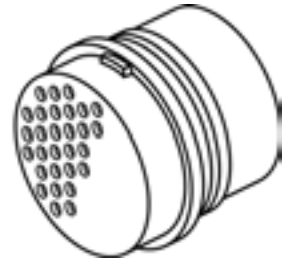

- Solder
- Crimp
- Metal Clip Retention
- Dielectric Retention

May include a soft front interfacial seal (Bonded) if dielectric is hard, and a rear sealing grommet separate or attached.

### Contact and Contact Termination Style

Pin – Crimp\*



Socket – Crimp\*



Pin – Solder

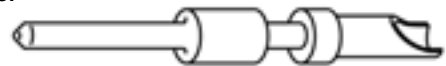

Socket – Solder



\*Crimp is removable

### Sizes by Wire Gauge, Examples:

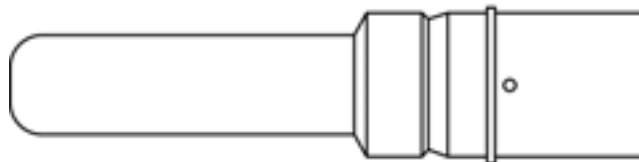

4/0 American  
Wire Gauge 4/0



22D American Wire Gauge 22-28

## Nomenclature: Cylindrical Connectors and Contacts, cont.

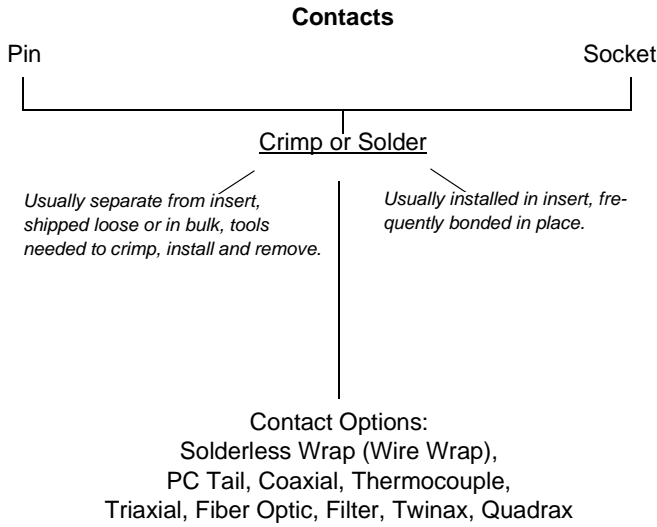

### Contact Sizes

Contact Size	22D	22M	22	20	16
American Wire Gauge	22-28	24-28	22-26	20-24	16-20
Wire Size (AWG)					

Contact Size	12	8	4	0
American Wire Gauge	12-14	8-10	4-6	0-2
Wire Size (AWG)				

### Accessories

- Adapters
  - straight, 90°, 75°
  - conduit, environmental, open wire bundle, EMI, etc.
- Compression ring – wire seal
- Clamp – cable sealing
- Stain relief – clamp, kellems grip
- Potting boot
  - straight, angle, universal

## Contact Versatility - Several types of Contacts can be designed into a Connector Shell

MIL-DTL-38999 connectors allow users to mix a variety of different power, signal, shielded, fiber optic and high speed contact styles within a common insert.

The insert arrangement below is an arrangement for Tri-Start MIL-DTL-38999 Series III connectors. It shows the variety of contacts that can be designed into a shell size 25. Typically, customers specify the contacts sizes and power they require and chose an existing arrangement that fits their needs. For special new configurations, engineering will design the arrangement of contacts to fit within material and performance criteria.

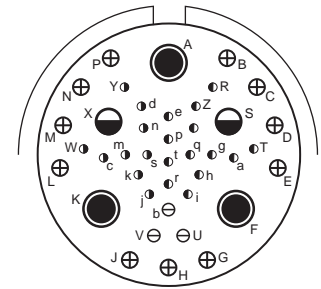

Insert Arrangement	25-41				
Number of Contacts	22	3	11	2	3
Contact Size	22D	20	16	12 Coax	8 Twinax



## Contacts and Fiber Optic Termini for Cylindrical Connectors

Amphenol's broad contact product range for Cylindrical Connectors includes:

- Standard 500 cycle and 1500 cycle, M39029 type power and signal contacts
- Crimp contacts for front or rear release connector applications
- Solder type, fixed contacts with cup or eyelet termination
- Thermocouple contacts
- RADSOK® sockets for high amperage power contacts
- Spring-loaded and push-pull types
- Filter contacts: Pi type tubular or Pi type planar for MF, HF, VHF, and UHF frequencies
- High frequency shielded coax, triax and twinax contacts
- High speed differential twinax and quadrax contacts
- For cylindrical connector attachment to Printed Circuit Boards:
  - PC tail contacts for signal and power applications, in coax, twinax, triax, differential twinax and quadrax designs
  - Compliant pin (Press fit) contacts
- Fiber optic Termini: MIL-T-29504 type or MT ferrules or ARINC 801 termini

# SECTION II

## Major MIL-Specifications by Type

- **Standard, MIL-DTL-5015**
  - **Amphenol 97 Series**
  - **Heavy Duty, MIL-DTL-22992**
  - **Proprietary Variations**
- Older larger series of connectors
  - Found on many pieces of military equipment and commercial applications
  - Mostly heavy current carrying connectors
  - Early types had only solder type contacts
  - Later revision to MIL Spec also added crimp type contacts
  - Amphenol supplies both the solder and crimp types to the MIL Spec
  - Amphenol supplies both solder and crimp versions under proprietary part numbers
  - Several variations of basic MIL-DTL-5015 and MIL-DTL-22992 types are available in the same and additional contact arrangements, such as the QWL, QWLD, 10-214000 Series, 10-244000 Series and others.
  - See Amphenol catalog sections:
    - MIL-DTL-5015 Cylindrical 12-020,
    - MIL-DTL-5015 Modifications 12-021,
    - Heavy Duty Cylindrical 12-052,
    - Commercial Aircraft Cylindrical 12-101,
    - 97 Series (MIL-DTL-5015 Proprietary) 12-022,
    - GT Series Bayonet 12-024.
  - Basic part number for MIL-DTL-5015 Series as supplied by Amphenol is MS310X A, C, E, F or R
  - MIL-DTL-5015 threaded coupling - 1 key/keyway shell polarization

MIL-DTL-5015 Shell Styles	
3100	Wall Mount Receptacle
3101	Cable Connecting Receptacle*
3102	Box Mount Receptacle
3106	Straight Plug
3108	90° Plug
3107	Quick Disconnect Plug (97 Series only)

### Contact Sizes

Contact Size	16	12	8	4	0
American Wire Gauge Wire Size (AWG)**	16-20	12-14	8-10	4-6	0-2

\* This connector style is sometimes referred to as a cable connecting "plug." It does, however, mate with either a straight or 90 degree plug.  
 \*\* Crimp adapter for small gauge wire is available, part number 10-074696-XXX.

## MIL-DTL-5015 Part Number

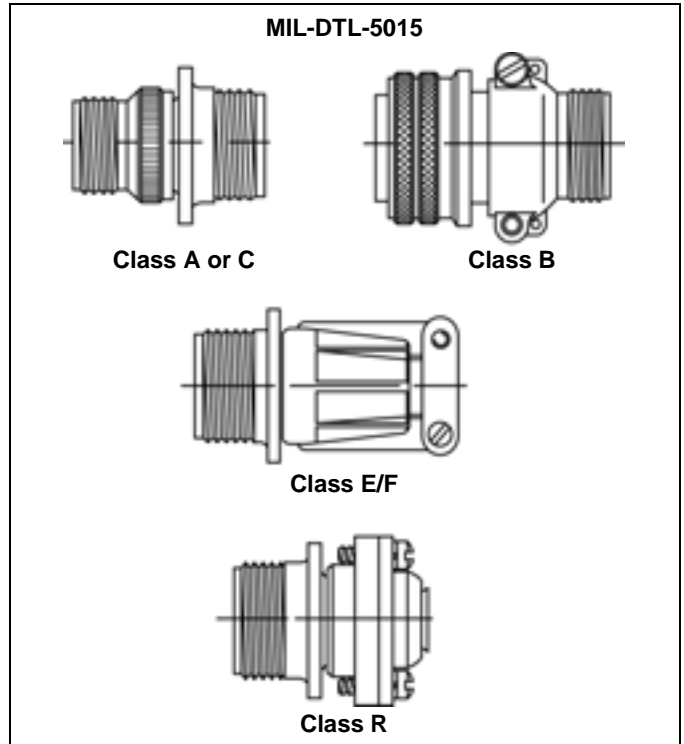
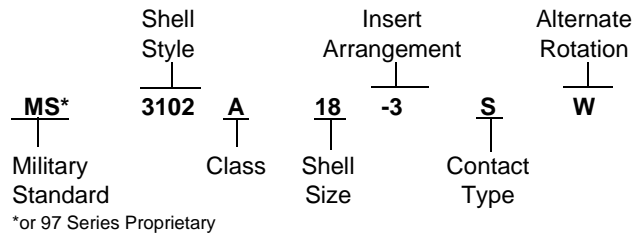

### Mating Halves

- Plugs: MS3106, MS3107, MS3108 or 97-3106, 97-3107, 97-3108
- Receptacles: MS3100, MS3102, MS3101, 97-3101, 97-3100, 97-3102

### Other Non-MIL-Mates, Flange Mounted

- Flange Mounted Plug: FP3106, 97-5105
- Thru-bulkhead Receptacle: TBF

See also 10-74XXX and 10-873XX in catalog section MIL-DTL-5015 Mods. for jam nut receptacles (Non-MIL)

### Alternate Positions of Insert Arrangements

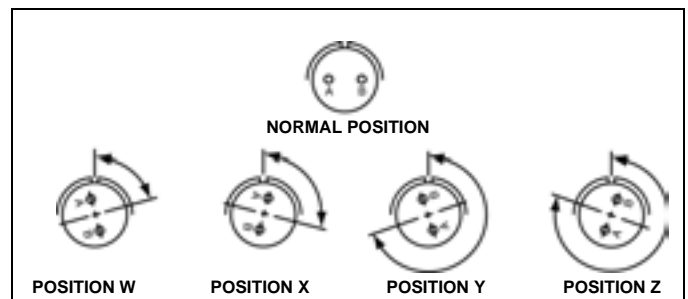

## Heavy Duty Cylindrical Connectors

- **Class L** - for the heaviest loads
  - Current range 40 to 200 amperes
  - Direct current or single/three phase, 60/400 Hertz alternating current
  - Automatic grounding for safety
- **QWLD** - for most power and control circuits
  - Military qualified connectors and commercial equivalents available
  - Increased shell size for greater durability than similar standard connectors
- **Class L and QWLD** have 5 key/keyway shell polarization and double stub thread coupling
- **QWL** – a more economical, compact heavy duty design for commercial power and control applications; single key shell polarization and double stub thread coupling

## MIL-DTL-22992 Series Connectors

### Classes C, R and L

#### Part Number Breakdown

The ordering procedure for QWLD MS-Approved Connectors is illustrated by part number MS17343R20N27PW as shown below:

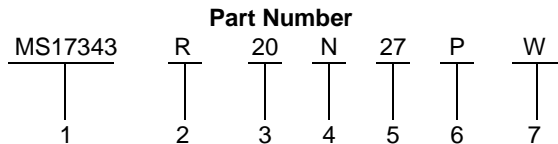

See code below:

1. MS Numbers
  - MS17343 designates wall mount receptacle
  - MS17344 designates straight plug
  - MS17345 designates cable connecting receptacle
  - MS17346 designates box mount receptacle
  - MS17347 designates jam nut receptacle with rear accessory threads (wall mount)
  - MS17348 designates jam nut receptacle (box mount)
2. Class
  - C designates pressurized; used where circuit integrity is protected by a pressure differential
  - R designates environmental; (see Heavy Duty Cylindrical catalog 12-052 for definition)
3. Shell Size
  - Available in shell sizes 12 through 44. See catalog 12-052 for dimensional data
4. Shell Finish
  - C for conductive or N for non-conductive
5. Insert Arrangement
  - Current MS insert arrangements are listed in catalog 12-052, Heavy Duty Cylindrical
6. Contact Type
  - “P” designates pin contacts; “S” for socket contacts

### 7. Alternate Insert Rotations:

Used to prevent cross-mating of connectors. Absence of a letter in this space indicates normal (0°) position of the insert. See catalog for alternate insert rotation illustrations.

See catalog 12-052 for proprietary equivalents such as 10-194XXX Series. Also see catalog 12-053 for QWL Series.

The ordering procedure for Class “L” Connectors is illustrated by part number MS90555C32412SY as shown below:

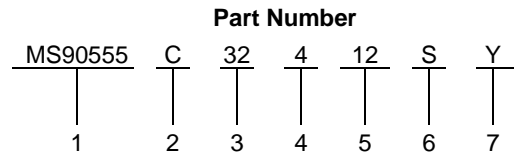

See code below:

### 1. MS Numbers

- MS90555 designates wall mount receptacle (power source)
- MS90556 designates straight plug
- MS90557 designates cable connecting receptacle without coupling ring
- MS90558 designates wall mount plug with coupling ring (equipment end)

### 2. Shell Finish

C (conductive) for AC or N (non-conductive) for DC circuits

### 3. Shell Size

Relates directly to current carrying capability

Size 28 – 40 amperes

Size 32 – 60 amperes

Size 44 – 100 amperes

Size 52 – 200 amperes

### 4. Main shell Key/keyway Position

N designates normal position. Three other positions (4, 5 and 6) of the main shell key/keyway prevent cross-mating or incompatible voltages. Refer to the individual connector style descriptions in catalog 12-052 for applicability.

### 5. Insert Arrangement

Determined by connector size (current carrying capability) and cable configuration to be accommodated. See catalog for insert arrangement pattern illustrations.

### 6. Contact Type

“P” designates pin contacts. “S” for socket contacts. MS90555 and MS90557 are supplied with socket contacts only. MS90556 and MS90558 are supplied with pin contacts only.

### 7. Alternate Insert Rotation

Used to prevent cross-mating of incompatible frequencies. Absence of a letter in this space indicates normal (0°) position of the insert. See catalog for individual insert arrangement description.

# SECTION III

## Major MIL-Specifications by Type

- Miniature, MIL-DTL-26482

### Miniature PT-Types MIL-DTL-26482

- Widely used smaller connectors
- Extensive use on military equipment including aircraft as well as commercial applications
- Available with either crimp or solder type contacts
- 3 point bayonet coupling
- Popular low cost series
- 5 Key/keyway shell polarization
- Amphenol supplies MIL-Spec types as well as proprietary versions
- MS311X or PT, solder type contacts (Series 1)
- MS312X or PT-SE, crimp type contacts (front release) (Series 1)
- MS347X or MB1, crimp type contacts (rear release) (Series 2)
- Modifications of Basic Series are:
  - PT-CE, crimp type contacts (front release) no MIL P/N, intermates with MS connectors
  - PC, double stub threaded coupling, bright cadmium plated, - (available with either crimp or solder contacts) no MIL P/N, does not intermate with PT types
  - SP, same as PT except wider flanges for back panel mounting, anodic coating, no MIL P/N, intermates with MS connectors
  - DC, same as PT except resistant to aircraft fluids, no MIL P/N, intermates with MS connectors
  - Other modifications and specials available
- For details on above series see Amphenol catalog sections:
  - “Miniature Cylindrical” 12-070
  - “Commercial Aircraft Cylindricals” 12-101.

MIL-DTL-26482 Series 2 is the same as MIL-DTL-83723 Series 1 and will intermate with all PT connectors. The Series features rear removable contacts – accessories are ordered separately. MIL-DTL-83723 Series 1 has been superseded by MIL-DTL-26482 Series 2.

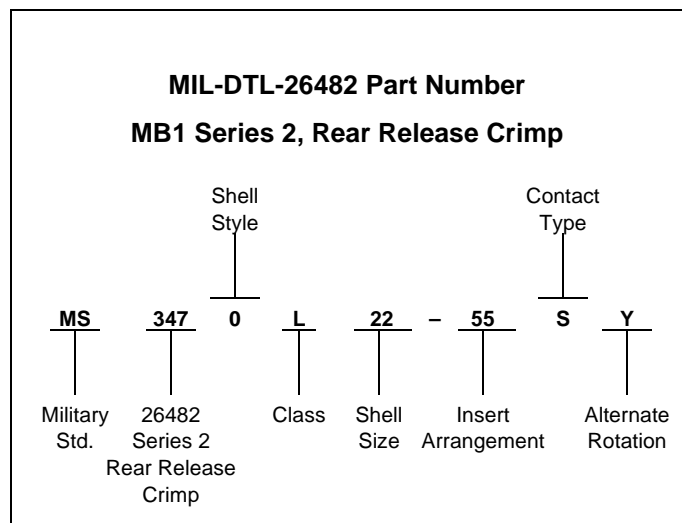
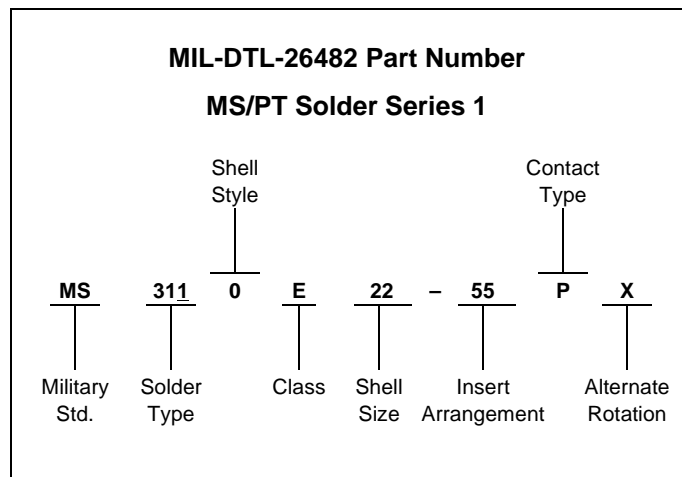
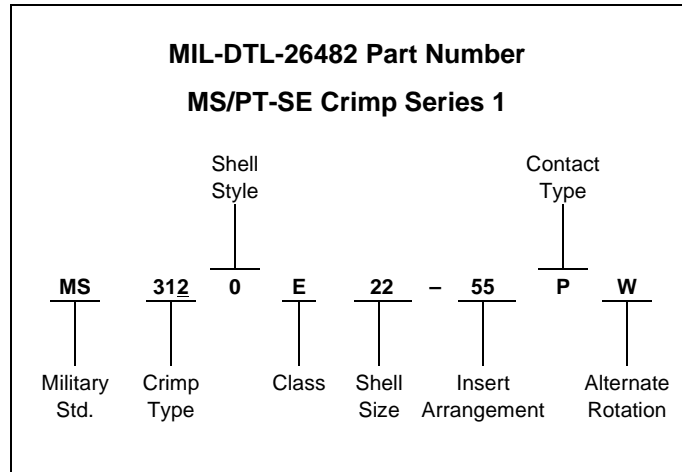



**How to Order BY MILITARY PART NUMBER**  
**MIL-DTL-26482 Series 2 Connectors**

<u>MS</u>	<u>3470</u>	<u>W</u>	<u>12</u> – <u>10</u>	<u>P</u>	<u>W</u>
<u>1</u>	<u>2</u>	<u>3</u>	<u>4</u> <u>5</u>	<u>6</u>	<u>7</u>

1. Connector Type  
MS designates Military Standard
2. Connector Style  
3470 wall mounting receptacle with narrow flange  
3472 wall mounting receptacle with wide flange  
3471 cable connecting receptacle  
3474 jam nut receptacle  
3476 straight plug  
3475 straight plug with RFI grounding fingers
3. Service Class  
L aluminum shell, electroless nickel finish, fluid resistant insert  
A aluminum shell, black anodized finish, non-conductive fluid resistant insert  
W aluminum shell, olive drab cadmium plated, fluid resistant insert  
  
Note: For stainless steel shell, passivated, order by Amphenol®/Matrix® proprietary Class G.  
Class L inactivates older classes E and R (Ref. MIL-C-26482)
- 4., 5. Shell size and insert arrangement - See chart on page 9 and pattern drawings that follow.
6. Contact Types  
P designates pin  
S designates socket  
A designates less pins  
B designates less sockets  
  
Note: Use A & B only when other than a full complement of power contacts is to be installed.
7. Insert Rotation  
“W”, “X”, “Y”, “Z” designate that insert is rotated in its shell from normal position. No letter required for normal (no rotation) position.

**How to Order BY PROPRIETARY PART NUMBER**  
**MIL-DTL-26482 Series 2 Connectors**

<u>MB1</u>	<u>0</u>	<u>W</u>	–	<u>12</u>	<u>10</u>	<u>P</u>	<u>W</u>	<u>***</u>
<u>1</u>	<u>2</u>	<u>3</u>	<u>4</u>	<u>5</u>	<u>6</u>	<u>7</u>	<u>8</u>	

1. Connector Type  
MB1 designates Amphenol®/Matrix® Bayonet Coupling Connector
2. Connector Style  
0 wall mounting receptacle with narrow flange  
1 wall mounting receptacle with wide flange  
3 cable connecting receptacle  
4 jam nut receptacle  
6 straight plug  
8 straight plug with RFI grounding fingers
3. Service Class  
A aluminum shell, black anodize finish, non-conductive, fluid resistant insert  
R aluminum shell, electroless nickel finish, fluid resistant insert  
G stainless steel shell, passivated, fluid resistant insert  
W aluminum shell, cadmium plated, olive drab finish, fluid resistant insert
- 4., 5. Shell size and insert arrangement - See chart on page 9 and pattern drawings that follow.
6. Contact Types  
P designates pin  
S designates socket
7. Insert Rotation  
“W”, “X”, “Y”, “Z” designate that insert is rotated in its shell from normal position. No letter required for normal (no rotation) position.
8. Modification Number  
Consult Amphenol, Sidney, NY for information.  
For strain reliefs use the following modification codes:  
(189) E-nut M85049/31 configuration  
(190) Straight strain relief M85049/52 configuration  
(191) 90° strain relief M85049/51 configuration

For ordering information on accessories, such as protection caps and backshell hardware, contact Amphenol, Sidney, NY.

## Miniature Crimp Connectors Part Number Breakdown

### Proprietary Part Number Construction for Miniature Crimp Connectors

To more easily illustrate ordering procedures, part number PT00SE-20-41PW (SR) is shown as follows:

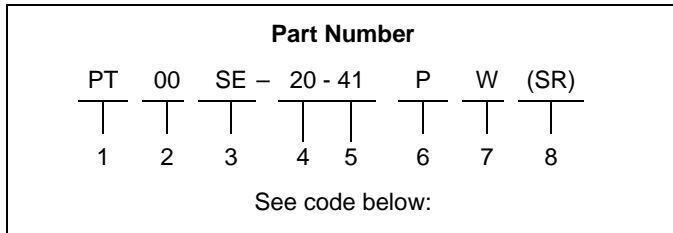

1. Connector Family
  - PT designates standard olive drab cadmium plated Tri-Lock coupling connector
  - SP designates connector similar to PT except for anodic coating and larger flange and mounting holes for back panel mounting of receptacles
2. Shell Style
  - "00" designates wall mount receptacle
  - "01" designates cable connecting receptacle
  - "02" designates box mount receptacle
  - "06" designates straight plug
  - "07" designates jam nut receptacle
  - "08" designates 90° plug
3. Service Class
  - "SE" designates crimp, environmental (MIL-DTL-26482)
  - "SP" designates crimp, potted type (MIL-DTL-26482)
  - Both of the above are Amphenol proprietary versions of the MIL-DTL-26482 Series 1 crimp contact connector and offer 15 lbs. contact retention for size 20 contacts, 25 lbs. for size 16 contacts.
  - "CE" designates crimp, environmental
  - "CP" designates crimp, potted type
  - Both of the above are original Amphenol crimp connectors and offer 7 lbs. contact retention for size 20 contacts, 9 lbs. for size 16 contacts.
4. "20" designates shell size. Shell sizes available are 8 through 24.
5. "20-41" designates insert arrangement
6. "P" designates pin contacts; "S" for socket contacts
7. "W" designates that insert is rotated in its shell from the standard position to alternate position W. The basic rotations are W, X, Y, and Z. No letter required for normal (no rotation) position.
8. "SR" designates a strain relief clamp. Deviation suffixes would be inserted here. For example, (005) would indicate the metal parts (except contacts) would have anodic coating.

### Part Number Nomenclatures for MS/PT Crimp Connectors to MIL-DTL-26482 Specification

To more easily illustrate ordering procedures, part number MS3120E-20-41PW is broken down as follows:

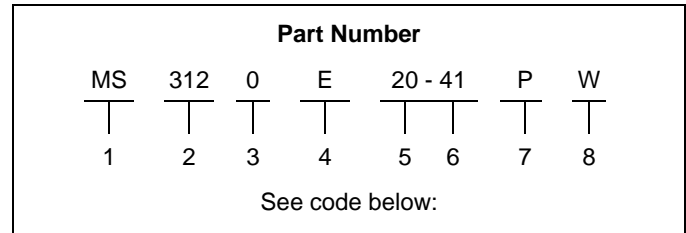

1. "MS" designates Military Standard
2. "312" designates basic family number for MIL-Spec 26482 crimp type
3. Shell Style
  - "0" designates wall mount receptacle
  - "1" designates cable connecting receptacle
  - "2" designates box mount receptacle
  - "4" designates jam nut receptacle
  - "6" designates straight plug
  - "7" designates box mount receptacle with dual mounting holes
  - "8" designates wall mount receptacle with dual mounting holes
4. Service Class
  - "E" designates environmental resisting connector
  - "F" designates environmental resisting connector with strain relief
  - "P" designates potted type with potting boot
5. "20" designates shell size. Shell sizes available are 8 through 24.
6. "20-41" designates insert arrangement
7. "P" designates pin contacts; "S" for socket contacts
8. "W" designates that the insert is rotated in its shell from the standard position to alternate position W. The basic rotations are W, X, Y, and Z. No letter required for normal (no rotation) position.

Cross Reference - Commercial PT to Comparable Military MS Types			
Amphenol P/N	MS P/N	Amphenol P/N	MS P/N
PT00SE	MS3120E	PT06SE(SR)	MS3126F
PT01SE	MS3121E	MF00SE(SR)	MS3128F
PT02SE	MS3122E	PT07SE(SR)	MS3124F
PT06SE	MS3126E	PT08SE(SR)	None
MF02SE	MS3127E	PT00SP	MS3120P
MF00SE	MS3128E	PT01SP	MS3121P
PT07SE	MS3124E	PT02SP	MS3122P
PT08SE	None	PT06SP	MS3126P
PT00SE(SR)	MS3120F	PT07SP	MS3124P
PT01SE(SR)	MS3121F		

## Miniature Solder Connectors Part Number Breakdown

### Part Number Nomenclature for Miniature Solder Connectors

To more easily illustrate ordering procedures, part number PT00A-20-41PW (SR) is shown as follows:

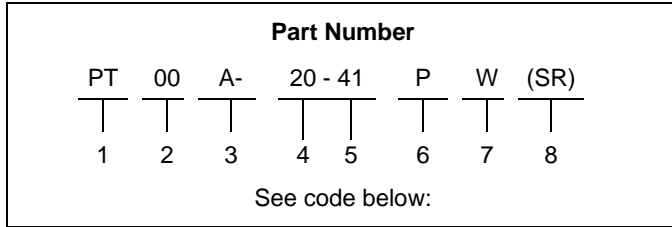

#### 1. Connector Family

PT designates standard olive drab cadmium plated Tri-Lock coupling connector. This is the Amphenol® proprietary version of the MIL-DTL-26482 solder contact connector.

PC designates a bright cadmium plated connector with double stub thread coupling

SP designates connector similar to PT except for anodic coating and larger flange and mounting holes for back panel mounting

#### 2. Shell Style

“00” designates wall mount receptacle

“01” designates cable connecting receptacle

“02” designates box mount receptacle

“06” designates straight plug

“07” designates jam nut receptacle

PTB designates thru-bulkhead receptacle

PTI designates solder mount receptacle

#### 3. Service Class

“A” designates general duty backshell

“C” designates pressurized receptacle

“E” designates environmental resisting with grommet and clamping nut

“J” designates clamp assembly for moisture proofing multi-jacketed cables, with strain relief

“P” designates potted with potting boot

“W” designates clamp assembly for moisture-proofing, multi-jacketed cables

“H” designates hermetic seal receptacle

4. “20” designates shell size. Shell sizes available are 6 through 24.

5. “20-41” designates insert arrangement

6. “P” designates pin contacts; “S” for socket contacts

7. “W” designates that insert is rotated in its shell from the standard position to alternate position W. The basic rotations are W, X, Y, and Z. No letter required for normal (no rotation) position.

8. “SR” designates a strain relief clamp. Deviation suffixes would be inserted here. For example, (005) would indicate the metal parts (except contacts) would have alumilite plating.

### Part Number Nomenclatures for MS/PT Solder Connectors to MIL-DTL-26482 Specification

To more easily illustrate ordering procedures, part number MS3110E20-41PW is shown as follows:

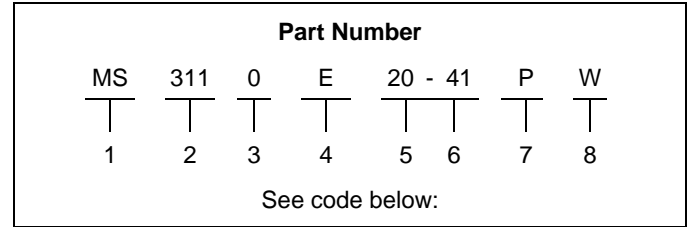

1. “MS” designates Military Standard

2. “311” designates basic family number for MIL-Spec 26482 solder type

#### 3. Shell Style

“0” designates wall mount receptacle

“1” designates cable connecting receptacle

“2” designates box mount receptacle

“4” designates jam nut receptacle

“6” designates straight plug

#### 4. Service Class

“E” designates environmental resisting connector with grommet and clamping nut

“F” designates environmental resisting connector with grommet and strain relief

“J” designates clamp assembly for moisture proofing multi-jacketed cables, with strain relief

“P” designates potted type with potting boot

5. “20” designates shell size. Shell sizes available are 8 through 24.

6. “20-41” designates insert arrangement

7. “P” designates pin contacts; “S” for socket contacts

8. “W” designates that the insert is rotated in its shell from the standard position to alternate position W. The basic rotations are W, X, Y, and Z. No letter required for normal (no rotation) position.

Cross Reference - Commercial PT to Comparable Military MS Types			
Amphenol P/N	MS P/N	Amphenol P/N	MS P/N
PT00A	None	PT00E(SR)	MS3110F
PT01A	None	PT01E(SR)	MS3111F
PT02A	None	PT06E(SR)	MS3116F
PT06A	None	PT07E(SR)	MS3114F
PT07A	None	PT00P	MS3110P
PT00C	None	PT01P	MS3111P
PT02C	None	PT02P	None
PT07C	None	PT06P	MS3116P
PTB	MS3119Ref	PT07P	MS3114P
PT00E	MS3110E	PT00W	None
PT01E	MS3111E	PT01W	None
PT02E	MS3112E	PT06W	None
PT06E	MS3116E	PT02H	None
PT07E	MS3114E	PT07H	MS3114H
		PT1H	MS3113H

**Miniature Shell Styles**

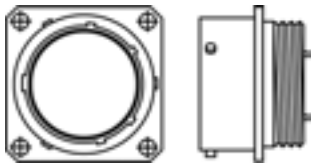

**Wall Mount Receptacle**

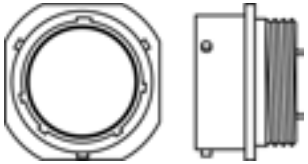

**Cable Connecting or Line Mount Receptacle\***

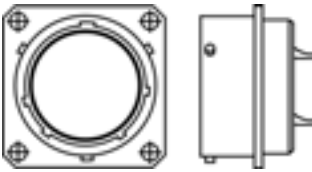

**Box Mount Receptacle**

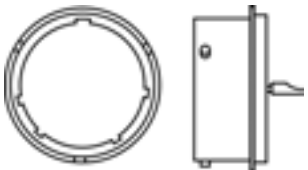

**Solder Mount Receptacle (Hermetic)**

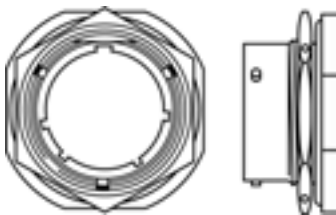

**Jam Nut Receptacle**

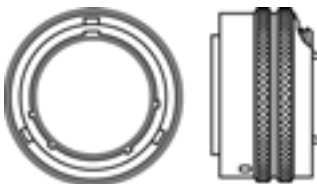

**Straight Plug**

Also see PTB - Thru-bulkhead, double-ended receptacle in Miniature Cylindrical catalog.

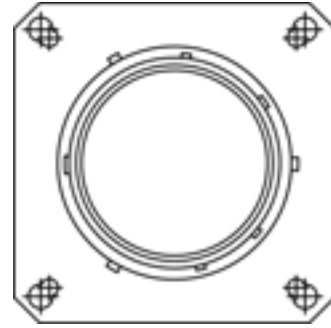

Wide Flange - Back Panel Mount:  
MS3127 Box Mount, MS3128 Wall Mount

**MIL-DTL-26482**

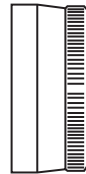

Class E

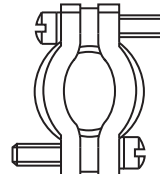

Class F

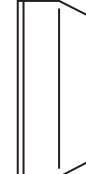

Class P

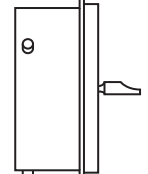

Class H

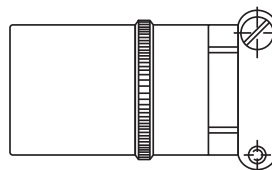

Class J

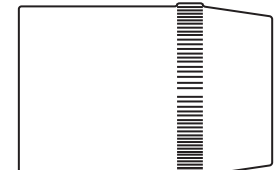

Class W  
(Non-MIL)

**Shell Sizes**

6, 8, 10, 12, 14, 16, 18, 20, 22, 24

**Contact Sizes**

Contact Size	20	16	12
American Wire Gauge Wire Size (AWG)	20-24	16-20	12-14

\* This connector style is sometimes referred to as a cable connecting "plug." It does, however, mate with either a straight or 90 degree plug.

# SECTION IV

## Major MIL-Specifications by Type

- Subminiature, MIL-DTL-38999\*
- MIL-DTL-27599

### Subminiature - JT/LJT, Tri-Start, SJT

- Preferred for new design by the Military
- Greatest growth potential of all cylindricals
- "State of the Art" technology and performance
- MIL-DTL-27599 has molded-in solder type contacts
- MIL-DTL-38999 has rear release, crimp removable contacts
- SJT has features of both the JT and LJT and is a NATO preferred connector in Europe
- MIL-DTL-38999 Series I & II will not intermate
- MIL-DTL-27599 Series I & II will not intermate
- MIL-DTL-38999 and MIL-DTL-27599, Series I and II will intermate respectively
- For more information, see Amphenol catalog section:
  - 12-C1\*, Subminiature Cylindrical Connectors designed to MIL-DTL-38999 and MIL-DTL-27599
  - 12-C1\*, Tri-Start Connector - MIL-DTL-38999 Series III
  - 12-091, SJT - Proprietary MIL-DTL-38999 type
  - 12-130, High Frequency Contact Catalog

### MIL-DTL-27599

#### Series I (LJT-Solder)

- 100% scoop-proof
- Molded-in solder type contacts
- Options include PCB, wire wrap contacts
- High contact density (up to 128 contacts)
- Shell grounding fingers standard on all plugs
- Intermateable with MIL-DTL-38999 Series I
- Bayonet coupling
- 5 key/keyway polarization with 4 alternate keyings

#### Series II (JT-Solder)

- Low profile, light-weight, non-scoop-proof
- Molded-in solder type contacts
- Options include PCB, wire wrap contacts
- High contact density (up to 128 contacts)
- Shell grounding fingers available as option on plug
- Intermateable with MIL-DTL-38999 Series II
- Bayonet coupling
- 5 key/keyway polarization with 4 alternate keyings

### MIL-DTL-38999

#### Series I (LJT-R)

- 100% scoop-proof
- High density arrangements (up to 128 contacts)
- Contact sizes 12 through 22D plus size 16, 12, 8 coax, and size 8 twinax
- Bayonet coupling
- DOD preferred
- Corrosion resistant (500 hr. salt spray) finish available
- Removable crimp, PCB, wire wrap, twinax, and coax contacts available
- Options include Hermetics, Filters and Thermocouples
- 5 key/keyway polarization with 4 alternate keyings
- Shell grounding fingers are standard on all plug
- Triple-web grommet seal
- Available in a Fail Safe Lanyard Release plug: see Amphenol catalog 12-C1.

#### Series II (JT-R)

- High density arrangements (up to 128 contacts)
- Low silhouette, light-weight non-scoop-proof
- Bayonet coupling
- Contact sizes 12 through 22D plus size 16 & 12 coax
- 5 key/keyway polarization with 4 alternate keyings
- Removable crimp, PCB, wire wrap and coax contacts available
- Corrosion resistant (500 hr. salt spray) finish available
- Options include Hermetics, Filters and Thermocouples
- Shell grounding fingers on plugs are an option
- Triple-web grommet seal
- Available in Fail Safe Lanyard Release plug

\* Catalog 12-C1 is Amphenol's new catalog - combining 38999 Series I, II and III Connectors. These were formerly catalogs 12-090 (Series I, II) and catalog 12-092 (Series III). Consult Amphenol Aerospace for the availability of this new catalog.

## Subminiature JT/LJT Part Number Breakdown

### PROPRIETARY PART NUMBER

To more easily illustrate ordering procedure, part number JT00RE-22-2PA ( ) is shown as follows:

Part Number							
JT	00	RE-	22-	2	P	A	( )
1	2	3	4	5	6	7	8/9

See code below:

- Connector Type:
  - JT designates standard Junior Tri-Lock connector
  - LJT designates long Junior Tri-Lock connector
  - LJTS JTS designates high temperature connector
  - LJTN JTN designates chemical and fuel resistant
  - JTL designates miniature mounting dimensions
  - JTLN designates miniature mounting dimensions – chemical resistant
  - JTLS designates miniature mounting dimensions – high temperature
  - LJTPQ JTPQ designates back panel mounted wall mounting receptacle
  - LJTP JTP designates back panel mounted box mounting receptacle
  - LJTPN JTPN designates back panel mounted – chemical resistant
  - LJTPS JTPS designates back panel mounted – high temperature
  - JTG\* designates plug with grounding fingers
  - JTNG\* designates plug with grounding fingers – chemical resistant

\*Grounding fingers standard on all LJT plugs.

- Shell Style
  - “00” designates wall mount receptacle
  - “01” designates line mount receptacle
  - “02” designates box mount receptacle
  - “06” designates straight plug
  - “07” designates jam nut receptacle
  - “08” designates 90-degree plug
  - “I” designates solder mount receptacle – hermetic
- Service Class: Solder contacts/connectors
  - “P” for potting applications – These connectors are supplied with a potting boot.† All shells are designed with integral features to retain potting boots
  - “A” for general duty applications (JT series only)
  - “A (SR)” – threaded rear design with strain relief †
  - “C” for pressurized applications
  - “C” (SR)” – threaded rear design with strain relief †
  - “H” for hermetic applications – Fused compression glass sealed inserts. Leakage rate less than .01 micron cu. ft/hr. (1 x 10<sup>-7</sup> cc/sec.) at 15 psi differential.
  - “Y” same as “H” with interfacial seal
  - “T” for MS27599A applications – General duty – pressurized (receptacles only) (LJT series only)

- Service Class: Crimp contacts/connectors
  - “RP” for potting crimp applications – Supplied with spacer grommet and potting boot.†
  - “RE” for environmental crimp applications – Supplied with a grommet and compression nut† (JT Series only). Can be supplied with strain relief integral with compression nut “RE (SR).”
  - “RT” for environmental applications – Supplied without rear accessories. Design provides serrations on rear threads of shells. For additional information defining complete description of service class, consult Amphenol, Sidney, NY.
- Shell Size
  - JT shell sizes available from 8 through 24. LJT shell sizes available from 9 through 25.
- Insert Arrangement:
  - 22-2 designates insert arrangement. Refer to catalog 12-C1 for additional insert patterns.
- Contact Style
  - “P” designates pin contacts; “S” designates socket contacts.
- Alternating Keying
  - “A” designates alternate keying connector assembly. Other basic alternate keys are “B”, “C” and “D”. No letter required for normal (no rotation) position.
- “SR” designates a strain relief clamp. Strain reliefs are available only on “A”, “C” and “RE” class connectors.
- Finish variation suffix.

† Not applicable to box mounting style.

Finish	Military Finish Data	Finish Suffix	Finish plus “SR” Suffix
Cadmium plated nickel base	A		(SR)
Olive drab cadmium plate nickel base	B	(014)	(386)
Electroless nickel	F	(023)	(424)
Anodic coating (Alumilite)	C	(005)	(300)
Chromate treated (Iridite 14-2)		(011)	(344)

### MILITARY TYPES

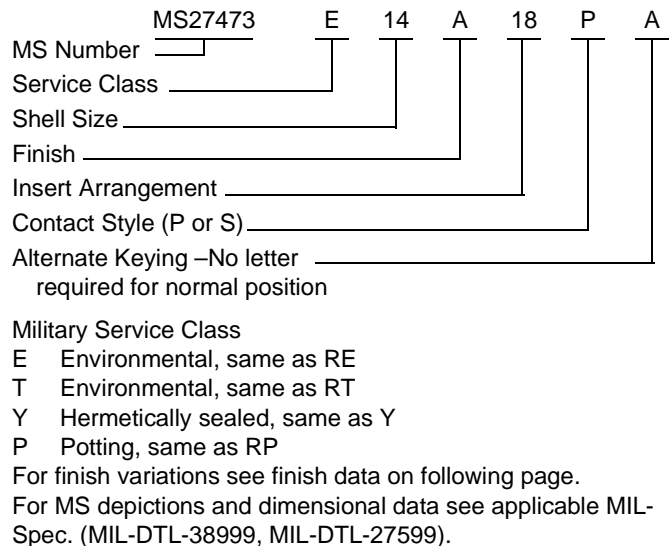

## Subminiature JT/LJT Specifications

### CONTACT RATING

Contact Size	Test Current		Maximum Millivolt Drop Crimp*	Maximum Millivolt Drop	
	Solder & Crimp	Hermetic		Solder*	Hermetic*
22M	3	2	45	20	60
22D	5	3	73		85
22	5	3	73	20	85
20	7.5	5	55	20	60
16	13	10	49	20	85
12	23	17	42	20	85
10 Power	33	NA	33	NA	NA

Contact Size	Crimp Well Data		Solder Well Data	
	Well Diameter	Nominal Well Depth	W Diameter	Nominal Well Depth
22M	.028 ± .001	.141	.029 <sup>+0.004</sup> <sub>-.000</sub>	.094
22D	.0345 ± .0010	.141	.034 <sup>+0.004</sup> <sub>-.000</sub>	.094
22	.0365 ± .0010	.141	.036 <sup>+0.004</sup> <sub>-.000</sub>	.094
20	.047 ± .001	.209	.044 <sup>+0.004</sup> <sub>-.004</sub>	.125
16	.067 ± .001	.209	.078 <sup>+0.000</sup> <sub>-.004</sub>	.141
12	.100 ± .002	.209	.116 <sup>+0.004</sup> <sub>-.002</sub>	.141
10 Power	.137 ± .002	.355	NA	NA

\* When tested using silver plated wire

### SERVICE RATING\*\*

Service Rating	Suggested Operating Voltage (Sea Level)		Test Voltage (Sea Level)	Test Voltage 50,000 Ft.	Test Voltage 70,000 Ft.	Test Voltage 110,000 Ft.
	AC (RMS)	DC				
M	400	500	1300 VRMS	550 VRMS	350 VRMS	200 VRMS
N	300	450	1000 VRMS	400 VRMS	260 VRMS	200 VRMS
I	600	850	1800 VRMS	600 VRMS	400 VRMS	200 VRMS
II	900	1250	2300 VRMS	800 VRMS	500 VRMS	200 VRMS

\*\* Please note that the establishment of electrical safety factors is left entirely in the designer's hands, since he is in the best position to know what peak voltages, switching surges, transients, etc. can be expected in a particular circuit.

### FINISH DATA

Aluminum Shell Components Non-Hermetic				
Finish	Suffix		Indicated Finish Standard for JT Types Listed Below	Standard for LJT Types Listed Below
	Military	Proprietary		
Cadmium Plated Nickel Base	MS (A)	-	JT/JTG/JTL/JTP	LJT/LJTP
Anodic Coating (Alumilite)	MS (C)	(005)	JTS/JTPS/JTLS	LJTSP/LJTS
Chromate Treated (Iridite 14-2)		(011)	JTN/JTPN/JTLN	LJTN/LJTPN
Olive Drab Cadmium Plate Nickel Base	MS (B)	(014)		
Electroless Nickel	MS (F)	(023)		

Hermetic Connectors				
Material Finish	Suffix		Indicated Finish Standard for JT Types Listed Below	Indicated Finish Standard for LJT Types Listed Below
	Military	Proprietary		
Carbon Steel Shell Tin Plated Shell and Contacts			JT ( ) H/JT ( ) Y JTL ( ) H/JTL ( ) Y	LJT ( ) Y/LJT ( ) H
Carbon Steel Shell Tin Plated Shell and Gold Plated Contacts	MS (D)	(452) special termination (468) solder cup		
Stainless Steel Shell Gold Plated Contacts	MS (E)	(162)	JTS ( ) Y JTLS ( ) Y	LJTS ( ) Y

**MIL-DTL-38999 LJT-R/JT-R and Accessories  
Cross Reference List**

Series or Accessory	MS Part No.	Amphenol Part No.	Description
Ac	MS27502AXXA	10-275197-XX7	Cap, Recept. Series I No Chain
Ac	MS27502BXXA	10-275197-XX9	
Ac	MS27502FXXA	10-275197-XXG	
Ac	MS27501AXXA	10-275196-XX7	Cap, Plug Series I, No Chain
Ac	MS27501BXXA	10-275196-XX9	
Ac	MS27501FXXA	10-275196-XXG	
Ac	MS27342AXX-1	10-440390-XX7 (Series II)	Adapter
Ac	MS27342BXX-1	10-440390-XX9 (Series II)	
Ac	MS27342CXX-1	10-440390-XX5 (Series II)	
Ac	MS27342FXX-1	10-440390-XXG (Series II)	
Ac	MS27342AXX-2	10-241055 Series II	
Ac	MS27342BXX-2	10-457452 Series I	
Ac	MS27342CXX-2		
Ac	MS27342FXX-2		
Ac	MS27510AXXA	10-241853-XX7	Cap, Plug Series II, No Chain
Ac	MS27510BXXA	10-241853-XX9	
Ac	MS27510CXXA	10-241853-XX5	
Ac	MS27510FXXA	10-241853-XXG	
Ac	MS27511AXXA	10-241856-XX7	Cap, Recept. Series II, No Chain
Ac	MS27511BXXA	10-241856-XX9	
Ac	MS27511CXXA	10-241856-XX5	
Ac	MS27511FXXA	10-241856-XXG	
I	MS27466EXXAXXP/S	LJT00RE-XX-XXP/S	Wall Mount Receptacle
I	MS27466EXXBXXP/S	LJT00RE-XX-XXP/S (014)	
I	MS27466EXXFXXP/S	LJT00RE-XX-XXP/S (023)	
I	MS27466TXXAXXP/S	LJT00RT-XX-XXP/S	
I	MS27466TXXBXXP/S	LJT00RT-XX-XXP/S (014)	
I	MS27466TXXFXXP/S	LJT00RT-XX-XXP/S (023)	
I	MS27466PXXAXXP/S	LJT00RP-XX-XXP/S	
I	MS27466PXXBXXP/S	LJT00RP-XX-XXP/S (014)	
I	MS27466PXXFXXP/S	LJT00RP-XX-XXP/S (023)	
I	MS27467EXXAXXP/S	LJT06RE-XX-XXP/S	Straight Plug
I	MS27467EXXBXXP/S	LJT06RE-XX-XXP/S (014)	
I	MS27467EXXFXXP/S	LJT06RE-XX-XXP/S (023)	
I	MS27467TXXAXXP/S	LJT06RT-XX-XXP/S	
I	MS27467TXXBXXP/S	LJT06RT-XX-XXP/S (014)	
I	MS27467TXXFXXP/S	LJT06RT-XX-XXP/S (023)	
I	MS27467PXXAXXP/S	LJT06RP-XX-XXP/S	Straight Plug
I	MS27467PXXBXXP/S	LJT06RP-XX-XXP/S (014)	
I	MS27467PXXFXXP/S	LJT06RP-XX-XXP/S (023)	
I	MS27468EXXAXXP/S	LJT07RE-XX-XXP/S	Jam Nut Mount Receptacle
I	MS27468EXXBXXP/S	LJT07RE-XX-XXP/S (014)	
I	MS27468EXXFXXP/S	LJT07RE-XX-XXP/S (023)	
I	MS27468TXXAXXP/S	LJT07RT-XX-XXP/S	
I	MS27468TXXBXXP/S	LJT07RT-XX-XXP/S (014)	
I	MS27468TXXFXXP/S	LJT07RT-XX-XXP/S (023)	
I	MS27468PXXAXXP/S	LJT07RP-XX-XXP/S	
I	MS27468PXXBXXP/S	LJT07RP-XX-XXP/S (014)	
I	MS27468PXXFXXP/S	LJT07RP-XX-XXP/S (023)	
I	MS27469YXXDXXP	LJT00Y-XX-XXP	Wall Mount Recept., Hermetic Seal
I	MS27469YXXEXXP	LJS00Y-XX-XXP	
I	MS27470YXXDXXP	LJT07Y-XX-XXP	Jam Nut Mount Recept., Hermetic Seal
I	MS27470YXXEXXP	LJS07Y-XX-XXP	
I	MS27471YXXDXXP	LJTIY-XX-XXP	Solder Mount Recept., Hermetic Seal
I	MS27471YXXEXXP	LJTSIY-XX-XXP	

Series or Accessory	MS Part No.	Amphenol Part No.	Description
II	MS27472EXXAXXP/S	JT00R-EXX-XXP/S	Wall Mount Receptacle
II	MS27472EXXBXXP/S	JT00RE-XX-XXP/S (014)	
II	MS27472EXXCXXP/S	JTS00R-EXX-XXP/S	
II	MS27472EXXFXXP/S	JT00RE-XX-XXP/S (023)	
II	MS27472TXXAXXP/S	JT00RT-XX-XXP/S	
II	MS27472TXXBXXP/S	JT00RT-XX-XXP/S (014)	
II	MS27472TXXCXXP/S	JTS00RT-XX-XXP/S	
II	MS27472TXXFXXP/S	JT00RT-XX-XXP/S (023)	
II	MS27472PXXAXXP/S	JT00RP-XX-XXP/S	
II	MS27472PXXBXXP/S	JT00RP-XX-XXP/S (014)	
II	MS27472PXXCXXP/S	JTS00RP-XX-XXP/S	
II	MS27472PXXFXXP/S	JT00RP-XX-XXP/S (023)	
II	MS27473EXXAXXP/S	JT06RE-XX-XXP/S	Straight Plug
II	MS27473EXXBXXP/S	JT06RE-XXP/S (014)	
II	MS27473EXXCXXP/S	JT06RE-XX-XXP/S	
II	MS27473EXXFXXP/S	JT06RE-XX-XXP/S (023)	
II	MS27473TXXAXXP/S	JT06RT-XX-XXP/S	
II	MS27473TXXBXXP/S	JT06RT-XX-XXP/S (014)	
II	MS27473TXXCXXP/S	JT06RT-XX-XXP/S	
II	MS27473TXXFXXP/S	JT06RT-XX-XXP/S (023)	
II	MS27473PXXAXXP/S	JT06RP-XX-XXP/S	
II	MS27473PXXBXXP/S	JT06RP-XX-XXP/S (014)	
II	MS27473PXXCXXP/S	JTS06RP-XX-XXP/S	
II	MS27473PXXFXXP/S	JT06RP-XX-XXP/S (023)	
II	MS27474EXXAXXP/S	JT07RE-XX-XXP/S	Jam Nut Mount Receptacle
II	MS27474EXXBXXP/S	JT07RE-XX-XXP/S (014)	
II	MS27474EXXCXXP/S	JTS07RE-XX-XXP/S	
II	MS27474EXXFXXP/S	JT07RE-XX-XXP/S (023)	
II	MS27474TXXAXXP/S	JT07RT-XX-XXP/S	
II	MS27474TXXBXXP/S	JT07RT-XX-XXP/S (014)	
II	MS27474TXXCXXP/S	JTS07RT-XX-XXP/S	
II	MS27474TXXFXXP/S	JT07RT-XX-XXP/S (023)	
II	MS27474PXXAXXP/S	JT07RP-XX-XXP/S	
II	MS27474PXXBXXP/S	JT07RP-XX-XXP/S (014)	
II	MS27474PXXCXXP/S	JTS07RP-XX-XXP/S	
II	MS27474PXXFXXP/S	JT07RP-XX-XXP/S (023)	
II	MS27475YXXDXXP	JT00Y-XX-XXP	Wall Mount Recept., Hermetic Seal
II	MS27475YXXEXXP	JTS00Y-XX-XXP	
II	MS27476YXXDXXP	JT02Y-XX-XXP	Box Mount Recept., Hermetic Seal
II	MS27476YXXEXXP	JTS0Y-XX-XXP	
II	MS27477YXXDXXP	JT07Y-XX-XXP	Jam Nut Mount Recept., Hermetic Seal
II	MS27477YXXEXXP	JTS07Y-XX-XXP	
II	MS27478YXXDXXP	JTIY-XX-XXP	Solder Mount Recept., Hermetic Seal
II	MS27478YXXEXXP	JTSIY-XX-XXP	
II	MS27479EXXCXXP/S	JTS00RE-XX-XXP/S	Wall Mount Recept., Inactive, Use MS27472
II	MS27479TXXCXXP/S	JTS00RT-XX-XXP/S	
II	MS27480EXXCXXP/S	JTS06RE-XX-XXP/S	Straight Plug, Inactive, Use MS27473
II	MS27480TXXCXXP/S	JTS06RT-XX-XXP/S	
II	MS27481EXXCXXP/S	JTS07RE-XX-XXP/S	Jam Nut Mount Recept., Inactive, Use MS27474
II	MS27481TXXCXXP/S	JTS07RT-XX-XXP/S	
II	MS27482YXXEXXP	JTS00Y-XX-XXP	Wall Mount Recept., Hermetic Seal, Inactive, Use MS27475
II	MS27483YXXEXXP	JTS07Y-XX-XXP	Jam Nut Mount Recept., Hermetic Seal, Inactive, Use MS27477



**MIL-DTL-38999 LJT-R/JT-R and Accessories**  
**Cross Reference List (Cont.)**

Series or Accessory	MS Part No.	Amphenol Part No.	Description
II	MS27484EXXAXXP/S	JTG06RE-XX-XXP/S	Straight Plug with Grounding Spring
II	MS27484EXXBXXP/S	JTG06RE-XX-XXP/S (014)	
II	MS27484EXXFXXP/S	JTG06RE-XX-XXP/S (023)	
II	MS27484TXAXXP/S	JTG06RT-XX-XXP/S	
II	MS27484TXBXXP/S	JTG06RT-XX-XXP/S (014)	
II	MS27484TXFXFP/S	JTG06RT-XX-XXP/S (023)	
II	MS27484PXXAXXP/S	JTG06RP-XX-XXP/S	
II	MS27484PXXBXXP/S	JTG06RP-XX-XXP/S (014)	
II	MS27484PXXFXFP/S	JTG06RP-XX-XXP/S (023)	
Ac	MS27485AXX	10-528399-XX7	Ring, Potting Boot, Series II
Ac	MS27485BXX	10-528399-XX9	
Ac	MS27485CXX	10-528399-XX5	
Ac	MS27485FXX	10-528399-XXG	
Ac	MS27486-XX-1	10-241912-XX	Potting, Boot Straight, Series II
Ac	MS27486-XX-2	10-241990-XX	Potting, Boot 90 Degree Series II
Ac	MS27487-XX-1	10-450910-XX, Includes MS27489	Kit, EMR Adapter, Straight, Series I & II
Ac	MS27487-XX-2	10-450911-XX	Kit, EMR Adapter, 90 Degree Series I & II,
Ac	MS27488-12-1	10-405996-121	Plug, Sealing Grommet
Ac	MS27488-16-1	10-405996-161	
Ac	MS27488-20-1	10-405996-201	
Ac	MS27488-22-1	10-405996-241	
Ac	MS27489-XXX	10-352425-XX	Adapter, Reducer EMR for use with MS27487
I	MS27490-XX	10-407035-XX5	Contact-Socket
II	MS27491-XX	10-251416-XX5	Contact-Socket
II	MS27492-XX	10-251416-XXH	Contact-Socket, Inactive, use MS27491
II	MS27493-XX	10-251415-XX5	Contact-Pin
II	MS27494-XX	10-251415-XXH	Contact-Pin, Inactive, use MS27493
I & II	MS27495R-XX	11-8675-XX	Tool, Contact, Removable, Metal
I & II	MS27495A-XX	11-8674-XX	Tool, Contact, Assembly, Metal
I	MS27496EXXAXXP/S	LJT02RE-XX-XXP/S	Box Mount Receptacle
I	MS27496EXXBXXP/S	LJT02RE-XX-XXP/S (014)	
I	MS27496EXXFXXP/S	LJT02RE-XX-XXP/S (023)	
II	MS27497EXXAXXP/S	JTPQ00RE-XX-XXP/S	Back Panel Wall Mount Receptacle.
II	MS27497EXXBXXP/S	JTPQ00RE-XX-XXP/S (014)	
II	MS27497EXXCXXP/S	JTPSQ00RE-XX-XXP/S	
II	MS27497EXXFXXP/S	JTPQ00RE-XX-XXP/S (023)	
II	MS27497TXXAXXP/S	JTPQ00RT-XX-XXP/S	
II	MS27497TXXBXXP/S	JTPQ00RT-XX-XXP/S (014)	
II	MS27497TXXCXXP/S	JTPSQ00RT-XX-XXP/S	
II	MS27497TXXFXFP/S	JTPQ00RT-XX-XXP/S (023)	
II	MS27497PXXAXXP/S	JTPQ002P-XX-XXP/S	
II	MS27497PXXBXXP/S	JTPQ002P-XX-XXP/S (014)	
II	MS27497PXXCXXP/S	JTPSQ002P-XX-XXP/S	
II	MS27497PXXFXFP/S	JTPQ002P-XX-XXP/S (023)	
II	MS27497VXXAXXP/S	JTP00RE-XX-XXP/S	
II	MS27497VXXBXXP/S	JTP00RE-XX-XXP/S (014)	
II	MS27497VXXCXXP/S	JTPSQ00RE-XX-XXP/S	
II	MS27497VXXFXFP/S	JTP00RE-XX-XXP/S (023)	

Series or Accessory	MS Part No.	Amphenol Part No.	Description
I	MS27498EXXAXXP/S	LJT08RE-XX-XXP/S	90 Degree Plug, Inactive for Design
I	MS27498EXXBXXP/S	LJT08RE-XX-XXP/S (014)	
II	MS27499EXXAXXP/S	JT02RE-XX-XXP/S	Box Mount Receptacle
II	MS27499EXXBXXP/S	JT02RE-XX-XXP/S (014)	
II	MS27499EXXCXXP/S	JTS02RE-XX-XXP/S	
II	MS27499EXXFXXP/S	JT02RE-XX-XXP/S (023)	
II	MS27500EXXAXXP/S	JT08RE-XX-XXP/S	90 Degree Plug, Inactive for Design
II	MS27500EXXBXXP/S	JT08RE-XX-XXP/S (014)	
I	MS27501AXXC	10-421399-XX7	Cover, Plug, with chain
I	MS27501BXXC	10-421399-XX9	
I	MS27501FXXC	10-421399-XXG	
I	MS27502AXXC	10-427406-XX7	Cover Receptacle, with chain
I	MS27502BXXC	10-427406-XX9	
I	MS27502FXXC	10-427406-XXG	
II	MS27503YXXEXXP	JTSIY-XX-XXP	Solder Mount Receptacle, Hermetic Seal Inactive, use MS27503
II	MS27504EXXCXXP/S	JTS00RE-XX-XXP/S	Box Mount Receptacle, Inactive, use MS27499
I	MS27505EXXAXXP/S	LJTP02RE-XX-XXP/S (023)	Back Panel Wall Mount Receptacle
I	MS27505EXXBXXP/S	LJTP02RE-XX-XXP/S (014)	
I	MS27505EXXFXXP/S	LJTP02RE-XX-XXP/S (023)	
I	MS27506AXX-1	10-436792-XX7	Adapter, Strain Relief, Clamp Bars
I	MS27506BXX-1	10-436792-XX9	
I	MS27506FXX-1	10-436792-XXG	
II	MS27506AXX-2	10-433992-XX7	
II	MS27506BXX-2	10-433992-XX9	
II	MS27506CXX-2	10-433992-XX5	
II	MS27506FXX-2	10-433992-XXG	
I & II	MS27507A-XX	10-415693-XX7	Adapter, 90 Degree, Strain Relief, Clamp Bars
I & II	MS27507B-XX	10-415693-XX9	
I & II	MS27507C-XX	10-415693-XX5	
I & II	MS27507F-XX	10-415693-XXG	
II	MS27508EXXAXXP/S	JTP02RE-XX-XXP/S	Back Panel Box Mount Receptacle
II	MS27508EXXBXXP/S	JTP02RE-XX-XXP/S (014)	
II	MS27508EXXCXXP/S	JTPS02RE-XX-XXP/S	
II	MS27508EXXFXXP/S	JTP02RE-XX-XXP/S (023)	
I & II	MS27509R-XX	10-296943-XX	Tool, Contact Removal and Assembly, Plastic Inactive, use M81969/14
I & II	MS27509A-XX	10-296940-XX	
II	MS27510AXXC	10-241801-XX7	Cap, Plug with chain
II	MS27510BXXC	10-241801-XX9	
II	MS27510CXXC	10-241801-XX5	
II	MS27510FXXC	10-241801-XXG	
II	MS27511AXXC	10-241800-XX7	Cap, Receptacle, with chain
II	MS27511BXXC	10-241800-XX9	
II	MS27511CXXC	10-241800-XX5	
II	MS27511FXXC	10-241800-XXG	
II	MS27511AXXR	10-241866-XX7	Cap, Receptacle with wire rope
II	MS27511BXXR	10-241866-XX9	
II	MS27511CXXR	10-241866-XX5	
II	MS27511FXXR	10-241866-XXG	
II	MS27510 ( )XXR	10-241864-	Cap, Plug with wire rope
II	MS27511 ( )XXN	10-241802-	Cap, Receptacle, Jam Nut, with chain

**MIL-DTL-38999 LJT-R/JT-R and Accessories**  
**Cross Reference List (Cont.)**

Series or Accessory	MS Part No.	Amphenol Part No.	Description
II	MS27512-XXA	10-101917-XX7	Nut, Hex
II	MS27512-XXB	10-101917-XX9	
II	MS27512-XXC	10-101917-XX5	
II	MS27512-XXE	10-260548-XX	
II	MS27512-XXF	10-101917-XXG	
II	MS27513EXXAXXP/S	JT02RE-XX-XXP/S	Box Mount Receptacle, Full Length Grommet
II	MS27513EXXAXXP/S	JT02RE-XX-XXP/S (014)	
II	MS27513EXXCXXP/S	JTS02RE-XX-XXP/S	
II	MS27513EXXFXXP/S	JT02RE-XX-XXP/S (023)	
I	MS3186AXXW	10-123017-XX7	Nut, Hex
I		10-123017-XX9	
I		10-195959-XX	
I		10-123017-XXG	
I	MS27515EXXAXXP/S	LJTP00RE-XX-XXP/S	Black Panel Wall Mount Receptacle, Inactive, Use MS27656
I	MS27515EXXBXXP/S	LJTP00RE-XX-XXP/S (014)	
I & II	MS81969/14-04	10-538988-12	Tool, Contact Insertion/ Removal, Plastic
I & II	MS81969/14-03	10-538988-16	
I & II	MS81969/14-10	10-538988-20	
I & II	MS81969/14-01	10-538988-22D	
I	MS39029/59	21-33101-XX	Contact, Socket, Shielded
I	MS39029/60	21-33102-XX	Contact, Pin, Shielded
I	MS27652EXXFXXP/S	LJTS00RE-XX-XXP/S (023)	Wall Mount Receptacle Inactive, Use MS27466
I	MS27652TXXFXXP/S	LJTS00RT-XX-XXP/S (023)	
I	MS27653EXXFXXP/S	LJTS06RE-XX-XXP/S (023)	Straight Plug, Inactive, Use MS27467
I	MS27653TXXFXXP/S	LJTS06RT-XX-XXP/S (023)	
I	MS27654EXXFXXP/S	LJTPS00RE-XX-XXP/S (023)	Back Panel Wall Mount Recept. Inactive, Use MS27656
I	MS27654TXXFXXP/S	LJTPS00RT-XX-XXP/S (023)	
I	MS27655-XX	10-407035-XXH	Contact, Socket, Inactive, Use MS27490
I	MS27656EXXAXXP/S	LJTPQ00RE-XX-XXP/S	Back Panel Wall Mount Receptacle
I	MS27656EXXFXXP/S	LJTPQ00RE-XX-XXP/S (014)	
I	MS27656EXXFXXP/S	LJTPQ00RE-XX-XXP/S (023)	

Series or Accessory	MS Part No.	Amphenol Part No.	Description
I	MS27656TXXAXXP/S	LJTPQ00RT-XX-XXP/S	Back Panel Wall Mount Receptacle
I	MS27656PXXBXXP/S	LJTPQ00RT-XX-XXP/S (014)	
I	MS27656PXXFXXP/S	LJTPQ00RT-XX-XXP/S (023)	
I	MS27656PXXAXXP/S	LJTPQ00RP-XX-XXP/S	Back Panel Wall Mount Receptacle
I	MS27656PXXBXXP/S	LJTPQ00RP-XX-XXP/S (014)	
I	MS27656PXXFXXP/S	LJTPQ00RP-XX-XXP/S (023)	
I	MS27661EXXAXXP/S	87-538800/74	Straight Plug, Lanyard Release
I	MS27661EXXBXXP/S	88-538800/74	
I	MS27661EXXFXXP/S	91-538800/74	
I	MS27662EXXAXXC	LJTB-XX-XXX	Thru-Bulkhead Mount Receptacle
I	MS27662EXXBXXC	LJTB-XX-XXX	
I	MS27662EXXCXXC	LJTB-XX-XXX	
I	MS27662EXXFXXC	LJTB-XX-XXX	
I & II	MS27663AXX-1	10-482790-XX7	Adapter Nut, Non-Metallic (Nylon Only)
I & II	MS27663BXX-1	10-482790-XX9	
I & II	MS27663CXX-1	10-482790-XX5	
I & II	MS27663FXX-1	10-482790-XX6	Adapter 90 Degree, Non-Metallic (Nylon Only)
I & II	MS27663AXX-2	10-482494-XX7	
I & II	MS27663BXX-2	10-482494-XX9	
I & II	MS27663CXX-2	10-482494-XX5	
I & II	MS27663FXX-2	10-482494-XX6	
II	MS27664EXXAXXP/S	JTPQ00RE-XX-XXP/S	Back Panel Wall Mount Receptacle, Inactive Use MS27497
II	MS27664EXXBXXP/S	JTPQ00RE-XX-XXP/S (014)	
II	MS27664EXXCXXP/S	JTPSQ00RE-XX-XXP/S	
II	MS27664EXXFXXP/S	JTPQ00RE-XX-XXP/S (023)	
II	MS27664TXXAXXP/S	JTPQ00RT-XX-XXP/S	
II	MS27664TXXBXXP/S	JTPQ00RT-XX-XXP/S (014)	
II	MS27664TXXCXXP/S	JTPSQ00RT-XX-XXP/S	
II	MS27664TXXFXXP/S	JTPQ00RT-XX-XXP/S (023)	
I	MS27665		Rack and Panel, Cancelled
	MS27666	DNS	
II	MS27667EXXBXXC	JTB-XX-XX	Thru-Bulkhead UTZ Receptacle
II	MS27667EXXCXXC	JTB-XX-XX	
II	MS27667EXXFXXC	JTB-XX-XX	
	MS27668	DNS	
	MS27669	DNS	
	MS27670	DNS	

**Subminiature Tri-Start**

**How to Order – Amphenol® TV, metal and Amphenol® TV26 CLUTCH-LOK®**

**Proprietary Part Number**

Amphenol® Tri-Start Connectors (metal) can be ordered by coded part number. Ordering procedure is illustrated by part number TVPS00RF-9-35P B (XXX) as shown below:

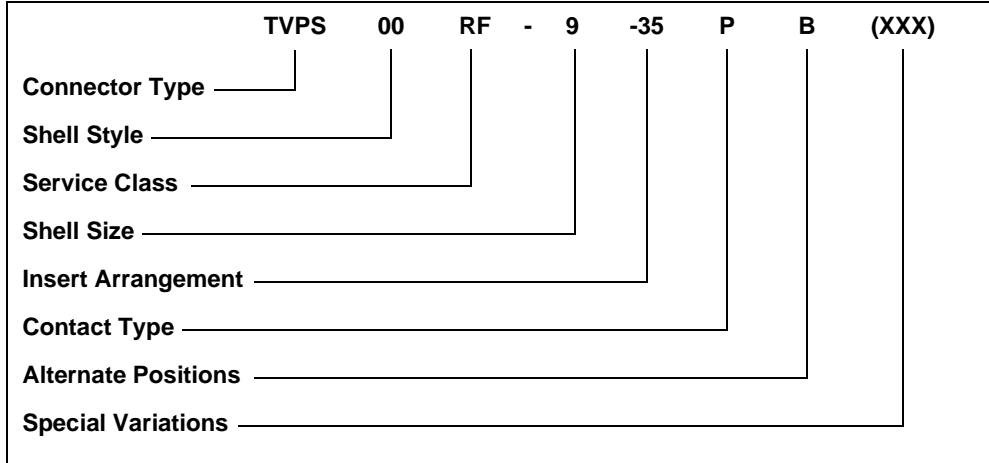

**Connector Type**

- TV designates Tri-Start Series Connector
- TVP designates back panel mounted receptacle
- TVS designates 200°C rated
- TVPS designates back panel mounted, 200°C rated receptacle

**Shell Style**

- 00 designates wall mount receptacle
- 01 designates line receptacle
- 02 designates box mount receptacle
- 06 designates straight plug
- 26 designates proprietary CLUTCH-LOK high vibration straight plug (available in service classes RK and RS only)
- 07 designates jam nut receptacle
- 09 designates flange mounted plug
- IY designates solder mounted receptacle, hermetic only
- HIY designates weld mounted receptacle, hermetic only

**Service Class**

- RX alternate finish, requires special variation suffix. Example: non-conductive, anodic coated aluminum is defined by variation suffix 005. Consult Amphenol, Sidney NY for details, options and availability of non-cadmium or nickel finishes.
- RF electroless nickel plated aluminum, optimum EMI shielding effectiveness –65dB @ 10GHz specification min., 48 hour salt spray, 200°C
- RGF\*\* electroless nickel plated ground plane aluminum, 200°C
- RGW\*\* olive drab cadmium plated ground plane aluminum, 175°C
- RK\* corrosion resistant stainless steel, firewall capability, plus 500 hour salt spray resistance, EMI –45 dB @ GHz specification min., 200°C
- RW corrosion resistant olive drab cadmium plate aluminum, 500 hour extended salt spray, EMI –50 dB @ 10 GHz specification min., 175°C
- RQF same as RF except with Quadrax contacts
- RGQF same as RGF except with Quadrax contacts
- RGQW same as RGW except with Quadrax contacts

- RQK same as RK except with Quadrax contacts and not firewall capable
- RQW same as RW except with Quadrax contacts
- Y hermetic seal, passivated stainless steel, 200°C
- RS\* (non-hermetic connectors), nickel plated stainless steel, optimum EMI shielding effectiveness –65dB @ 10 GHz specification min., 500 hour salt spray, 200°C, firewall barrier
- YN (hermetic connectors), nickel plated stainless steel, 200°C
- DN Durmalon plated, Nickel-PTFE alternative to cadmium. Corrosion resistant, 1,000 hour salt spray, EMI-50dB at 10GHz specification min., 175 degrees

**Shell Size**

MIL-DTL-38999, Sizes 9-25.

A	B	C	D	E	F	G	H	J	MIL Shell Size
9	11	13	15	17	19	21	23	25	Amphenol® Shell Size

**Insert Arrangement**

MIL-DTL-38999, see insert arrangement charts in catalog 12-C1

**Contact Type**

- P designates pin contacts
- S designates socket contacts

**Alternate Positions**

Locksmith keying - rotation of minor keys. See catalog 12-C1 "N" not required for normal position.

**Special Variations**

Consult Amphenol Aerospace, Sidney, NY for variations.

\* Coaxial arrangements are not available in these classes.  
 \*\* For more information on Coax/Triax/Twinax Ground Plane Connectors consult Amphenol Aerospace.

NOTE: Catalog 12-C1 is Amphenol's new catalog - combining 38999 Series I, II and III. These were formerly catalogs 12-090 (Series I, II) and catalog 12-092 (Series III). This combined catalog will be available 4th Qtr. 2008.

## Subminiature Tri-Start

### How to Order – D38999, TV Military, metal and MTV26 CLUTCH-LOK®

#### Military Part Number

To more easily illustrate ordering procedure by military designation, part number D38999/20F A35P B is shown as follows:

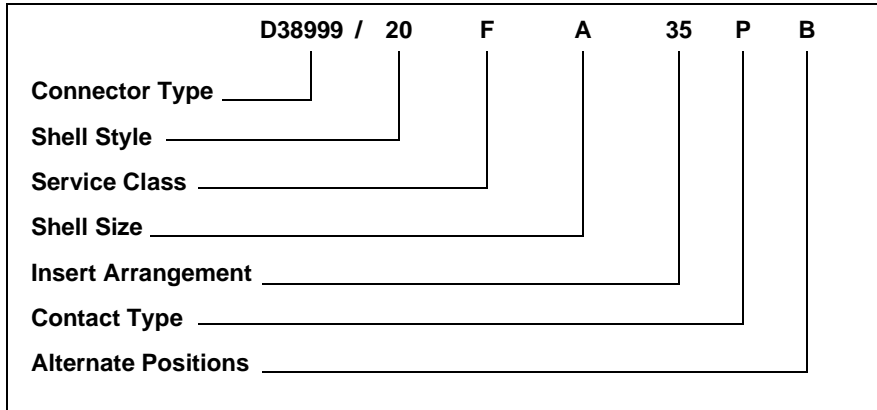

#### Connector Type

D38999/ designates MIL-DTL-38999 Series III Connector  
 MTV designates military D38999/26 CLUTCH-LOK high vibration straight plug (available in service class RK only)

#### Shell Style

- 20 designates wall mount receptacle
- 21 designates box mount receptacle, hermetic
- 23 designates jam nut receptacle, hermetic
- 24 designates jam nut receptacle
- 25 designates solder mount receptacle, hermetic
- 26 designates straight plug
- 27 designates weld mount receptacle, hermetic
- 29 designates Lanyard Release plug with pin contacts\*
- 30 designates Lanyard Release plug with socket contacts\*
- 31 designates Lanyard Release plug with MIL-STD-1760 pin contacts\*

\* For ordering Amphenol® Lanyard Release Connectors, consult catalog 12-C1. Ordering procedure for Lanyard Release Connectors includes specifying lanyard length codes and designating Style 1 or 2.

#### Protection Caps (see catalog 12-C1)

- 32 designates plug protection cap
- 33 designates receptacle protection cap

#### Service Class

- C non-conductive, anodic coated aluminum, 500 hour salt spray, 200 °C (environmental resisting)
- F electroless nickel plated aluminum, optimum EMI shielding effectiveness – 65dB @ 10GHz specification min., 48 hour salt spray, 200 °C (conductive, environmental resisting)
- G space grade, electroless nickel, 48 hour salt spray, 200 °C
- K corrosion resistant stainless steel, firewall capability, plus 500 hour salt spray resistance, EMI – 45 dB @ 10 GHz specification min., 200 °C
- L corrosion resistant steel, electro-deposited nickel, 48 hour salt spray, 200 °C

- W corrosion resistant olive drab cadmium plate aluminum, 500 hour extended salt spray, EMI – 50 dB @ 10GHz specification min., 175 °C
- Y hermetic seal, passivated stainless steel, 200 °C
- S (non-hermetic connectors), nickel plated stainless steel, optimum EMI shielding effectiveness – 65 dB @ 10 GHz specification min., 48 hour salt spray, 200 °C
- N (hermetic connectors), nickel plated stainless steel, 200 °C

#### Shell Size

MIL-DTL-38999, Size 9 – 25

A	B	C	D	E	F	G	H	J	MIL Shell Size
9	11	13	15	17	19	21	23	25	Amphenol® Shell Size

#### Insert Arrangement

MIL-DTL-38999, see catalog 12-C1

#### Contact Type

- P designates pin contacts
- S designates socket contacts
- A designates same as “P” except supplied less pin contacts
- B designates same as “S” except supplied less socket contacts (A & B designates non-standard contact applications)
- X designates eyelet contacts, hermetics only

#### Alternate Positions

Locksmith keying - rotation of minor keys. See catalog 12-C1. Use “N” for normal position

#### Special Variations

Consult Amphenol Aerospace, Sidney, NY for variations.

Amphenol® Cage Code 77820

**Subminiature Tri-Start  
How to Order –Amphenol® CTV, composite**

**Proprietary Part Number**

Amphenol® Tri-Start Composite Connectors can be ordered by coded part number. Ordering procedure is illustrated by part number CTVPS00RF-9-35PB as shown below:

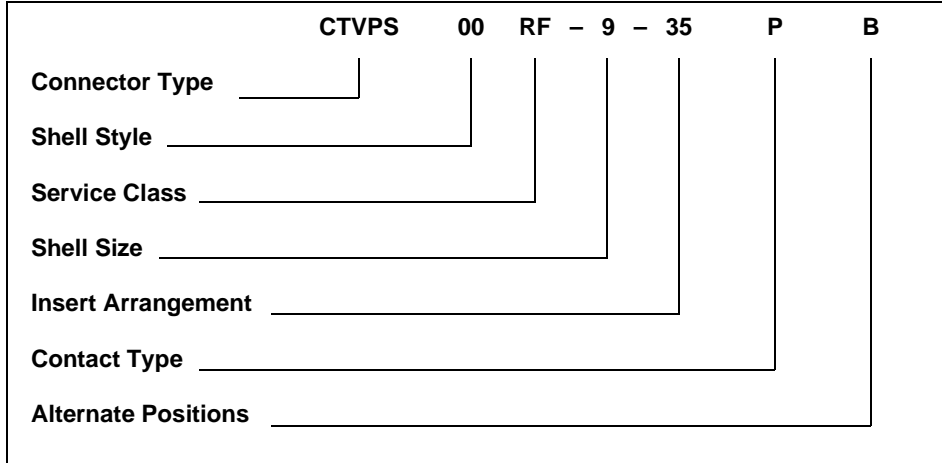

**Connector Type**

- CTV designates Tri-Start Series Connector
- CTVP designates panel mounted receptacle
- CTVS designates 200°C rated
- CTVPS designates panel mounted, 200°C rated receptacle

**Shell Style**

- 00 designates wall mount receptacle
- 01 designates line receptacle
- 02 designates box mount receptacle\*
- 06 designates straight plug
- 07 designates jam nut receptacle

**Service Class**

- RF electroless nickel plated composite, 200°C, 2000 hour salt spray
- RW olive drab cadmium plated composite, 175°C
- RGF\*\* electroless nickel plated ground plane composite, 200°C
- RGW\*\* olive drab cadmium plated ground plane composite, 175°C
- RQF same as RF composite except with Quadrax contacts
- RQW same as RW composite except with Quadrax contacts
- RGQF same as RGF composite except with Quadrax contacts
- RGQW same as RGW composite except with Quadrax contacts
- DN Durmalon plated, Nickel-PTFE alternative to Cadmium. Corrosion resistant, 1,000 hour salt spray, EMI-50dB at 10GHz specification min., 175 degrees

**Shell Size**

9 thru 25 available

**Insert Arrangement**

MIL-DTL-38999, see catalog 12-C1

**Contact Type**

- H designates 1500 cycle pin contacts
- J designates 1500 cyclesocket contacts
- P designates 500 cycle pin contacts
- S designates 500 cycle socket contacts

**Alternate Positions**

Locksmith keying - rotation of minor keys. See catalog 12-C1. "N" not required for normal position.

\* Consult Amphenol Aerospace, Sidney, NY for availability.  
\*\* For more information on Coax/Triax/Twinax Ground Plane Connectors consult Amphenol Aerospace.

Amphenol® Cage Code 77820

NOTE:Catalog 12-C1 is Amphenol's new catalog - combining 38999 Series I, II and II. These were formerly catalogs 12-090 (Series I, II) and catalog 12-092 (Series III). This combined catalog will be available 4th Qtr. 2008.

**Subminiature Tri-Start  
How to Order –D38999, CTV military, composite**

**Military Part Number**

To more easily illustrate ordering procedure of Tri-Start Composite Connectors by military designation, part number D38999/20JG35PN is shown as follows:

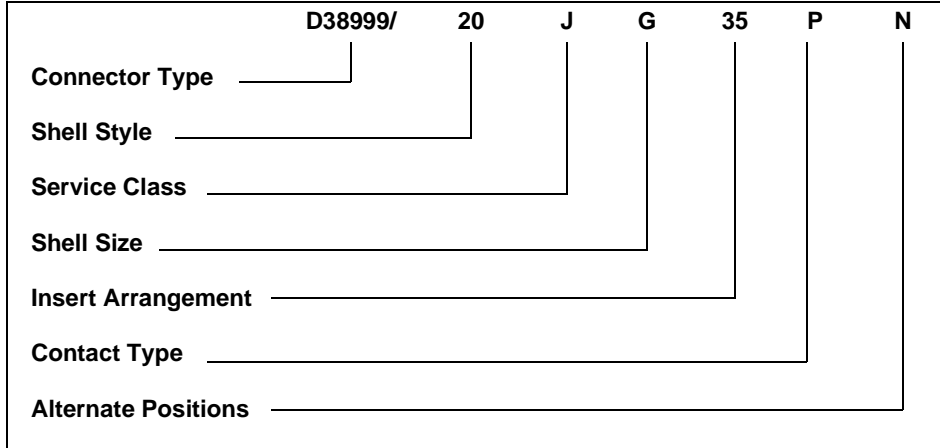

**Connector Type**

D38999/ designates MIL-DTL-38999 Series III Connector

**Shell Style**

20 designates wall mount receptacle  
 24 designates jam nut receptacle  
 26 designates straight plug  
 (Consult Amphenol Aerospace for availability of composite box mount receptacles)

**Service Class**

J olive drab cadmium plate (175°C),  
 2000 hrs. dynamic salt spray  
 M electroless nickel plate (200°C),  
 2000 hrs. dynamic salt spray

**Shell Size**

MIL-DTL-38999, Sizes 9-25

A	B	C	D	E	F	G	H	J	MIL Shell Size
9	11	13	15	17	19	21	23	25	Amphenol® Shell Size

**Insert Arrangement**

MIL-DTL-38999, see catalog 12-C1

**Contact Type**

H designates 1500 cycle pin contacts  
 J designates 1500 cycle socket contacts  
 P designates 500 cycle pin contacts  
 S designates 500 cycle socket contacts  
 A designates same as "P" except supplied less pin contacts  
 B designates same as "S" except supplied less socket contacts  
 (A & B designate non-standard contact applications)

**Alternate Positions**

Locksmith keying - rotation of minor keys. See catalog 12-C1 (Use N for normal).

## Subminiature Tri-Start Specifications

### MIL-DTL-38999, Series III (TV)

- 100% scoop-proof
- High density contact arrangements
- Contact sizes 12 through 22D plus size 8, 12, 16 coax, and size 8 twinax
- Removable crimp, PCB, wire wrap, coax, triax, twinax and high speed quadax and differential twinax contacts
- Fiber optics available with MIL-PRF-29504 termini, MT ferrule termini and ARINC 801 termini
- Options include Hermetics, Filters and Thermocouples
- Self-locking, quick disconnect threaded coupling
- Corrosion resistant - shells of stainless steel or cadmium plate over nickel withstand a 500 hour salt spray exposure
- Moisture resistance - improved interfacial seal design prevents electrolytic erosion of contacts
- EMI shielding - designed to obtain metal-to-metal coupling, the TV connector provides a superior EMI shielding capability
- Vibration/Shock - operates under severe, high temperature shock and vibration testing through 200° C
- Clutch-Lok™ MIL-DTL-38999 Series III High Vibration Connector - All advantages of stainless steel/Class K firewall Tri-Start connectors plus a unique clutch design that actually tightens itself under vibration
- Firewall capability - available in stainless steel shell, Class K
- Composite Tri-Start, qualified to MIL-DTL-38999, Rev. J - offers a lightweight, corrosion resistant connector with the same high performance features as it's metal counterpart.
  - Light weight: 17% – 70% weight savings
  - Corrosion resistance: withstands 2000 hrs. of salt spray exposure
  - Durability: 1500 connector couplings
- Locksmith keying - 5 keyway polarization provides 5 alternate rotations
- Shell grounding fingers are standard on all plugs
- Triple-web grommet seal
- DOD preferred
- Available in a Fail Safe Lanyard Release plug
- See catalog 12-C1

NOTE: Catalog 12-C1 is Amphenol's new catalog - combining 38999 Series I, II and III. These were formerly catalogs 12-090 (Series I, II) and catalog 12-092 (Series III)

### CONTACT RATING

Contact Size	Test Current		Maximum Millivolt Drop*	
	Crimp	Hermetic	Crimp**	Hermetic**
22D	5	3	73	85
20	7.5	5	55	60
16	13	10	49	85
12	23	17	42	85
10 (Power)	33	NA	33	NA

\* Maximum Millivolt Drop data is determined by measuring resistance of mated contacts from end to end

\*\* When using silver plated wire

Contact Size	Crimp Well Data		Hermetic Well Data	
	Well Diameter	Nominal Well Depth	Well Diameter	Min. Well Depth
22D	.0345 ± .0010	.141	.036 +.004 -.000	.094
20	.047 ± .001	.209	.044 +.004 -.000	.125
16	.067 ± .001	.209	.078 +.004 -.002	.141
12	.100 ± .002	.209	.116 +.004 -.002	.141
10 (Power)	.137 ± .002	.355	NA	NA

### FINISH DATA

Non-Hermetic Shell Components		
Finish	Service Class	
	Military	Proprietary
Anodic Coating (Non-Conductive)	C	RX***
Electroless Nickel	F	RF
Olive Drab Cadmium Plate Nickel Base	W	RW
Stainless Steel with Nickel Plate	S	RS
Stainless Steel	K	RK
Olive Drab Cadmium Plate, Composite	J	RW
Electroless Nickel Plate, Composite	M	RF
Hermetic Connectors		
Material/Finish	Suffix	
	Military	Proprietary
Stainless Steel	Y	Y
Stainless Steel, Nickel Plate	N	YN

\*\*\* Add suffix (005) to part number

### SERVICE RATING†

Service Rating	Suggested Operating Voltage (Sea Level)		Test Voltage (Sea Level)	Test Voltage 50,000 Ft.	Test Voltage 70,000 Ft.	Test Voltage 110,000 Ft.
	AC (RMS)	DC				
M	400	550	1300 VRMS	550 VRMS	350 VRMS	200 VRMS
N	300	450	1000 VRMS	400 VRMS	260 VRMS	200 VRMS
I	600	850	1800 VRMS	600 VRMS	400 VRMS	200 VRMS
II	900	1250	2300 VRMS	800 VRMS	500 VRMS	200 VRMS

† Please note that the establishment of electrical safety factors is left entirely in the designer's hands, since he is in the best position to know what peak voltages, switching surges, transients, etc. can be expected in a particular circuit.

## Subminiature SJT Features, Part Number Breakdown

- 100% scoop-proof – Basic LJT lengths
- Basic JT mounting dimensions
- Bayonet coupling
- 5 key/keyway polarization with 4 alternate keyings
- Rear release crimp contacts
- PCB, wire wrap, twinax and coax contacts available
- High density insert patterns available
- Shell grounding fingers are an option on the plug
- Options include Hermetics, Filters and Thermocouples
- See catalog 12-091

## SJT How to Order

### PART NUMBER

To more easily illustrate ordering procedure, part number SJT00RT-18-66PA( ) is shown as follows:

SJT	00	RT	–	18	–	66	P	A	( )
└───┘	└───┘	└───┘		└───┘		└───┘	└───┘	└───┘	└───┘
1	2	3		4		5	6	7	8

See code below:

#### 1. Connector Type

SJT designates standard scoop-proof Junior Tri-Lock Connector

SJTS designates high temperature connector

SJTG designates plug with grounding fingers

SJTP designates back panel mounted

#### 2. Shell Style

00 designates wall mount receptacle

06 designates straight plug

07 designates jam nut receptacle

I designates solder mount receptacle – hermetic

#### 3. Service Class

“Y” for hermetic applications, fused compression glass sealed inserts. Leakage rate less than .01 micron cu. ft./hr. ( $1 \times 10^{-7}$  cc/sec.) at 15 psi differential, with interfacial seal.

“RT” for environmental applications - supplied without rear accessories. Design provides serrations on rear threads of shells.

For additional information defining complete description of service class, consult Amphenol, Sidney, NY.

#### 4. SJT shell sizes available from 8 through 24.

#### 5. – 66 designates insert arrangement

#### 6. P designates pin contacts; S for socket contacts

#### 7. A designates a rotated connector assembly (alternate keying). Other basic rotations are B, C and D. No letter required for normal, (no rotation) position

#### 8. Finish variation suffix



# SECTION V

## Cross Reference by MIL-Spec to Competitor's Part Number

### MIL-DTL-5015 (Solder Type) Typical Part No. - MS310X

Class	Amphenol		ITT Cannon
	A, C, E, F, R	A, B	A, C, E, F, B, K, R
Proprietary Part No. (A.N.-M.S.)	GP, SC, SF CS, SG, SB SM, ACS	MS310X or 97310X	CA310X
Shell Size:			
MS3100	X	X	X
MS3101	X	X	X
MS3102	X	X	X
MS3103	X	X	X
MS3106	X	X	X
MS3107	see 97 Series	X	X
MS3108	X	X	X

Amphenol Proprietary Interates: 10-214XXX, 10-244XXX  
(Crimp types - front removal)

Amphenol Proprietary Non-Interates: (5015 Type)  
See also Heavy Duty Class "L", Amphenol QWLD (MIL-DTL-22992),  
catalog 12-052  
See also Heavy Duty QWL, catalog 12-053  
See also GT Series Reverse Bayonet Coupling, catalog 12-024

### MIL-DTL-5015 (Crimp - Front Release) Typical Part No. - MS340X

Amphenol	S.A.E.	Trans Tech (Flight)	Cannon
DNS*	MOXD, MIXD	FF	WFS

### MIL-DTL-5015 (Crimp - Rear Release) Typical Part No. - MS3450X

Amphenol	ITT	S.A.E.	Trans Tech	Aero Electric
944X	CV345X	M5X	MS	AE

### MIL-DTL-22992 Typical Part No. - MS1734X

Amphenol	ITT Cannon
10-194XXX	WLDX (shell sizes 18 & 32 only)

### MIL-DTL-22992 Class L (Power Connector) Typical Part No. - MS9055X

Amphenol	General Connector
10-473XXX	GLCXX

### MIL-DTL-26500 (Crimp - Front Release) Typical Part No. - MS24266X

Amphenol/ Pyle	Amphenol	Cinch	RMS	Aero
ZZ( )-	48-XX	C48-XX	R071X	AE66X

### MIL-DTL-26482 (Solder Type) Series 1 Typical Part No. - MS311X

	Amphenol	Souriau	Cannon	Framatome	Array	Veam
Type	PT	BT/851	KPT	851-00	PW	VPT
Shell Style:						
MS3110	X	X	X	X	X	X
MS3111	X	X	X	X	X	X
MS3112	X	X	X	X	X	X
MS3113	X	X	X			X
MS3116	X	X	X	X	X	X
MS3114	X	X	X	X	X	X

### MIL-DTL-26482 (Crimp - Front Release) Series 1 Typical Part No. - MS312X

	Amphenol	Burndy	Cannon	Array
Type	PT-SE	LTE, LTF	KP-SE	PWF
Shell Style:				
MS3120	X	X	X	X
MS3121	X	X	X	X
MS3122	X	X	X	X
MS3126	X	X	X	X
MS3124	X	X	X	X
MS3127	X	X	X	
MS3128	X	X	X	

Amphenol Proprietary Interates: DC, SP, BP; also PT-CE.

### MIL-DTL-26482 (Crimp - Rear Release) Series 2 Typical Part No. - MS347X

Amphenol	Cannon	Deutsch	Aero	Corsair
MB1	PV	AFD	AE	CT097

### MIL-DTL-81511 (Crimp - Rear Release) Series I & II Typical Part No. - M81511/0X

Amphenol
348-

### MIL-DTL-81511 (Crimp - Rear Release) Series III & IV Typical Part No. - M81511/4X

Amphenol	Deutsch
DNS*	B815

### MIL-DTL-83723 (Crimp - Rear Release) Series III Typical Part No. - M83723/71X

Amphenol/Pyle	Amphenol/Matrix	Amphenol	Deutsch
BTX/BYX	MB3X/MT3X	518-	DL60X

\*DNS - Do not supply

### Intermating Chart

MIL Series	All 5015	All* 26482	All 26500	Series I 38999	Series II 38999	Series III 38999	Series I 27599	Series II 27599	Series I 83723	Series II 82723	Series III 83723	Series I & II 81511	Series III & IV 81511
All 5015	X									X			
All 26482*		X							X				
All 26500			X								X		
Series I 38999				X			X						
Series II 38999					X			X					
Series III 38999						X							
Series I 27599				X			X						
Series II 27599					X			X					
Series I 83723		X							X				
Series II 83723	X									X			
Series III 83723			X										
Series I & II 81511												X	X
Series III & IV 81511												X	X

\* Except push pull coupling

### Cross Reference by MIL-Spec to Competitor's Part No. MIL-DTL-38999 (Crimp Rear Release) Series I, II, III and IV

Series	Amphenol	Cannon/Veam	G & H	American Pyle-National	Deutsch	Souriau	American Micro Products
I	LJT	KJL/LTT	-	T1	DJT	8LT	3C&B
II	JT	KJ	-	-	DJT	8T	XC7C-( )
III	TV-CTV	KJA/VTTG3XXX	G-300	T3	DTS	8D	X ( )C-(
IV	-	-	BLXX	-	DIV	-	

Series	Socapex	Amphenol LTD	Aero Electric	Deutsch LTD/ Dagan
I	LJT	LJT	AE16	DJT
II	-	JT	AE27	DTL
III	TV	TV	AE32	ACT/DTS
IV	-	-	-	-

Series	Herm Seal	Hi-Rel	Sealtron	Glenair
I	9150	7600	A9703	23X
II	9XXX	5X000	A980X	23X
III	HR	8000	A9903	23X
IV	-	-	-	23X

### MIL-SPEC Cross Reference Data and General Information

MIL-Spec	Description	Amphenol Proprietary Mates	Contact Termination & Removal	Contact Sizes in Series (Wire Gauge)	Coupling Method	Other Notes
MIL-DTL-5015	Power type connectors, large contacts Older series had solder contacts; newer has crimp	CS, SM, TBF 10-72XXX, GP, SC, SF, SG, SB, FP, 10-214XXX, 10-244XXX, 10-87XXX, etc.	Solder or crimp, front or rear removal	16 thru 0	Threaded	310X solder, 340X crimp F. R., 345X crimp R. R., GT Series Reverse Bayonet Coupling
MIL-DTL-26482 * Series 1 crimp	Miniature connector. Contacts are medium size, both power and signal currents, solder or crimp	PT, PT-SE, PT-CE, PTS-DR, BP, SP, DC	Solder or crimp, front or rear removal	20, 16, 12	Bayonet thread, version Non-Military	311X solder, 312X crimp F. R. 347X crimp R. R.
MIL-DTL-22992	Power type connector, heavy duty. MIL-C-5015 insert patterns, rugged. Solder or crimp contacts	QWLD 10-193XXX, Class L 10-473XXX, HK - potted backshell	Solder for MS1734X, Crimp for Military Class "L"	16 thru 0	Threaded (quick thread), double stub	Class L Series is for heavy power. MS9055X Class "L"
MIL-DTL-83723 *Series I, II & III	Series I mates with MIL-C-26482, 2 Series II mates with MIL-C-5015 Series III mates with MIL-C-26500	Refer to applicable series. BTK, BTW, BTR, BTA, BNK, BYK, BYR, BYW, BYA, BTY, BYY	Crimp, rear removal	20, 16, 12, 8, 0	Threaded and bayonet, depending on series	83723/1 thru 14, 36 thru 49 Series I, 17 thru 27 -29 -30 -33 -34 -35 -50 -52 -53 Series II, 7X -8X -9X Series III
MIL-DTL-38999	Subminiature - medium and high contact density, crimp contacts. Series I - scoop-proof	Series I, LJT-R, (Also see MIL-DTL-27599 solder)	Crimp, rear removal	22D, 20, 16, 12, and coax sizes 8, 12, 16	Bayonet	Intermates with Series I of MIL-DTL-27599
	Series II - lightweight, low profile	Series II, JT-R, (Also see MIL-DTL-27599 solder)	Crimp, rear removal	22D, 20, 16, 12, and coax sizes 12, 16	Bayonet	Intermates with Series II of MIL-DTL-27599
	Series III - High performance, but suited for general duty	Series III, TV-R, T3W, T3K, T3F, T3S, T3N, T3Y, Series III CTV - Composite	Crimp, rear removal	22D, 20, 16, 12, and coax sizes 8, 12, 16	Threaded	Available in Class K Firewall and Lan-yard Release Break-away
	Series IV Breech-Lok, expensive design, can be difficult to mate	None	Crimp, rear release	22D, 20, 16, 12, and coax sizes 8, 12, 16	Breech-Lok	Does not meet total performance requirements of Series III
MIL-DTL-26500	Miniature connector. Contacts are medium size, both power and signal, solder or crimp	ZZW, ZZL, ZZY, ZZB	Crimp, front removal	20, 16, 12	Bayonet and Threaded	Intermates with Series III of MIL-DTL-83723
MIL-DTL-81511*	Subminiature - medium and high contact density, crimp contacts. Series I & II - front release contacts Series III & IV - rear release contacts	348 Series	Crimp, front (gang) & rear removal	22, 20, 16, 12	Bayonet	M81511/0X F. R. M81511/4X R. R.
MIL-DTL-27599	Subminiature, similar to MIL-DTL-38999 except has non-removable solder contacts. Fully mateable with MIL-DTL-38999	LJT-T, P - Series I LJT-A, C, P - Series II	Solder	22, 20, 16	Bayonet	Intermates with Series I and II of MIL-DTL-38999

\* Denotes inactive

# SECTION VI

## Qualified Products List by Connector Specification

QPL No./Date	Qualified Product List	Manufacturer
QPL-5015-43 (6/07)	Series I, Solder Type MS3100 Series	Amphenol, ITT Cannon
	Series II, Front Release Crimp MS3400 Series	ElecSys. Inc., J-Tech, TRW Cinch
	Series III, Rear Release Crimp MS3450 Series	Amphenol/Matrix, ITT Cannon, J Tech, Aero Electric, ElecSys. Inc.
	Accessories only*	Glenair, Sunbank, Electro-Adapter, Electro-Sonic Components, Raychem, Triangle Electronics
QPL-26482-100 (4/08)	Series I, Solder MS3110 Series	Amphenol, Array, ITT Cannon, Souriau
	Hermetics only	Amphenol, ITT Cannon, Glasseal, Deutsch, Sealtron, CIA, Herm Seal
	Series I, Crimp MS3120 Series	Amphenol, Burndy, Cannon, Veam, Souriau, Array
	Series II, Hermetic (MS3400) Series	Deutsch, Glasseal, Herm Seal, Array, Sealtron
	Series II, Crimp MS3470 Series	Amphenol, Aero Electric, ITT Cannon, Deutsch, Corsair, Souriau
	Accessories only*	Sunbank, Glenair, Array
QPL-83723-66 (11/06)	Series I	Superseded by and transferred to MIL-DTL-26482 Series II
	Series II	ITT Cannon
	Series III	Amphenol, TRW Cinch, Deutsch, Pyle-National, Aero Electric, ITT Cannon
	Hermetics only	Connector Industries, Herm Seal, Sealtron
	Accessories only*	Glenair, Joslyn Sunbank
QPL-38999 (4/08)	Series I	Amphenol/Pyle, Amphenol Limited, Amphenol Socapex, Souriau, ITT Cannon, Deutsch, Aero Electric, JEC, Hi Rel
	Series II	Amphenol, ITT Cannon, Deutsch, Souriau, Aero Electric, Hi Rel
	Hermetics only	Herm Seal, Sealtron, American Micro Products, Glenair
	Series III	Amphenol, Amphenol Socapex, Amphenol/Pyle, TEC, Deutsch, Souriau, ITT Cannon, Amphenol Limited, Deutsch LTD, Hi Rel, Aero Electric, American Micro Products, Glenair
	Series IV	G & H Technology, Deutsch, Glenair
	Accessories only*	ESC, Joslyn Sunbank
QPL-22992-38 (1/08)	MS17340 Series (QWLD)	Amphenol, ITT Cannon
	Class "L" (MS90555) Series)	Amphenol, General Connector
QPL-27599-14 (12/07)	38999 Solder	Amphenol
QPL-26500-70 (12/05)	Miniature Cylindrical	Amphenol/Pyle, TRW Cinch, Aero Electric, Herm Seal, RMS
	Accessories only*	Glenair, ESC
QPL-81511-9 (12/98)		Amphenol, Deutsch
QPL-AS39029-2 (7/07)	MIL-C-26482 Series 1, Contacts	Amphenol/Pyle, Deutsch, ITT Cannon, Tri-Star, Cinch, Veam
	MIL-C-26482 Series 2, Contacts	Amphenol/Pyle, Deutsch, ITT Cannon, Tri-Star, NCM
	MIL-DTL-38999, Contacts	Amphenol/Pyle, ITT Cannon, Tri-Star, AMP, General Connector
	MIL-C-22992, Class "L", Contacts	Amphenol, General Connector
	Other Contacts	May include all of the above, plus: Continental Connector, AMP, J Tech. Precision Technology, Winchester and others

\* A General Note: Connector manufacturers also supply many of the accessories.

QPL listings change often. Manufacturers can be added or dropped at any time. This listing is current at the time of the printing of this publication (See back cover for printing date).  
Please check the current QPL when accurate information is required.

# Amphenol®/Pyle®/Matrix® Quick Product Guide

## Subminiature Cylindrical Connectors

### MIL-DTL-27599 Solder

Military #	Proprietary #
MS20026	LJT00
MS20027	LJT01
MS20028	LJT06
MS20029	LJT07
MS27334	JT00
MS27335	JT02
MS27336	JT06
MS27337	JT07

### MIL-DTL-38999 Series I & II

Military #	Proprietary #
MS27466	LJT00R
MS27467	LJT06R
MS27468	LJT07R
MS27469	LJT00Y
MS27470	LJT07Y
MS27472	JT00R
MS27473	JT06R
MS27474	JT06R
MS27475	JT00Y
MS27476	JT02Y
MS27477	JT07Y
MS27478	JTYI
MS27479	JTS00R
MS27482	JTS00Y
MS27483	JTS07Y
MS27484	JTG06R
MS27496	LJT02R
MS27497	JTPQ00R
MS27499	JT02R
MS27500	JT08R
MS27503	JTSIY
MS27505	LJTP02R
MS27508	JTP02R
MS27656	LJTPQ00R

### MIL-DTL-38999 Series III

	Metal	Composite (CTV)
D38999/20	TVP00R	CTVP00R
	TVP02R	CTVP02R
D38999/26	TV06R	CTV06R
D38999/24	TV07R	CTV06R
	TV01R	CTV01R
	TV09R	
D38999/21	TVPS02Y	
D38999/23	TVS07Y	Hermetic
D38999/25	TVSIY	
D38999/27		
D38999/29		TV Failsafe Lanyard
D38999/30		Release Plug
D38999/31		MIL-STD-1760 Plug

### High Density 38999

Inserts with 30% higher densities

### Other Proprietary 38999 Types

38999 with High speed shielded contacts  
 38999 with PCB contacts  
 38999 with High Frequency contacts  
 Clutch-Lok TV/MTV (for high vibration)  
 38999 with Flex circuitry  
 38999 Power with RADSOK® contacts  
 T-Line Series  
 Amphe-Lite Industrial  
 SJT (meets European Specifications)

### MIL-C-81511

Military #	Proprietary #
M81511/01E	348-40E
M81511/03E	348-43E
M81511/05E	348-41E
M81511/06E	348-46E
M81511/18	348-140
M81511/21E	348-30E
M81511/23E	348-33E
M81511/25E	348-31E
M81511/26E	348-36E

## Miniature Cylindrical Connectors

### MIL-DTL-26482 Series 1 Solder

Military #	Proprietary #
MS3110	PT00
MS3111	PT01
MS3112	PT02
MS3113	PTIH
MS3114	PT07
MS3114	PT07
MS3116	PT06

### MIL-DTL-26482 Series 1 Crimp

Military #	Proprietary #
MS3120	PT00SE
MS3121	PT01SE
MS3122	PT02SE
MS3124	PT07SE
MS3126	PT06SE
MS23127	MF02SE
MS3128	MF00SE

### MIL-DTL-26482 Series 2

	Amphenol part #	Matrix part #
MS3470	PTS00DR	MB10
MS3471	PTS01DR	MB13
MS3472	PTPS00DR	MB11
MS3474	PTS07DR	MB14
MS3475	PTGS06DR	MB16
MS3476	PTS06DR	MB18

### Other Proprietary (MIL-DTL-26482 Type)

PT-CE	SP-CE	PC-SE
SP	PC	PC-CE
SP-SE	Matrix MBL	RPT

### MIL-DTL-83723 Series III Available in Pyle or Matrix Part No.

M83723/71 thru /78
M83723/82 thru /92
M83723/95, /96
Matrix only: M83723/66 thru /69 Quick Disconnect
MB3, MT3

### MIL-DTL-26500

MS24264	ZZY
MS24265	ZZW
MS24266	MS27613
BACC45FN, FT, FS, FM	
MS27614	
BACC63BP, BV	MS27615
BACC63CB, CC	

### Other Proprietary Miniature Types

67 Series 165 Series

## Engine Connectors (Class K Firewall)

D38999/20	BACC63BR/BT
D38999/24	BACC63CN/CM
D38999/26	M83723/82-92
ESC-10, 11	M83723/95, /96, /97
EN2997	ASN-EO
MIL-DTL-26500 types:	
FPK, FPL, FP5K, FYL	

## Standard/Heavy Duty Cylindrical Connectors

MIL-DTL-5015 Solder	97 Series Solder	97 Series Crimp
MS3100	97-3100	97-4100
MS3101	97-3101	97-4101
MS3102	97-3102	97-4102
MS3106	97-3106	97-4106
MS3107	97-3107	97-4107
MS3108	97-3108	97-4108

97 Series is UL Approved file E115497(N) and CSA Approved certification file LR69183

### Matrix MIL-DTL-5015, Series III Crimp Rear Release

MS3450	9440
MS3451	9441
MS3452	9442
MS3454	9444
MS3456	9446
MS3459	9816
	9817 Quick Disconnect
	9818 Quick Disconnect

### Proprietary GT Series (5015 inserts) (Reverse Bayonet)

GT-A	GT-G	GT-AGG
GT-AF/F	GT-R	GT-PP
GT-CF/CFZ	GT-RV	GT-PC
GT-CFGG	GT-E	GTC-M
GT-LCF/LCFZ		Vortex GT

### Proprietary ACA-B Series

ACA-B Reverse Bayonet (5015 inserts)

### Proprietary AC Series

AC Threaded (5015 inserts)

### Heavy Duty

#### QWLD Class L

MS17343	MS90555
MS17344	MS90556
MS17345	MS90557
MS17346	MS90558
MS17347	
MS17348	

Pyle Star-Line (UL, CSA listed)

Pyle Star-Line EX (certified for use in Zone 1-IIC hazardous environment)

Pyle Star-Lok (UL, CSA listed)

Amphe-EX (ATEX and IECex rated)

RIG-Power & VFD rated inserts

### Other Proprietary Standard and Heavy Duty Types

Commercial Aircraft types:

DC Series and 10-244 Series

BT-M, BT-MA and BT-RA

Other Proprietary types:

Pre-Earth FMLB Series, 7 Series,

MS Modified types,

QWL, QWP Heavy duty types

### Amphe-Power Connectors with High Amperage RADSOK® Sockets

Amphe-Power P-Lok

Amphe-Power GT (Amphe-GTR and Power GT)

Amphe-Power 5015 (AC Series)

Amphe-BU, Amphe-Armor, Amphe-Y

RADSOK® technology is being incorporated into Mil-Aero products: Rectangulars and LRM, 38999, 5015

### RADSOK® Busbar Products

Amphe-PD	RADLOK
SurLok	RADSERT
Tru-Loc	PGY
Amphe-Base	PowerBlok
Amphe-Com	

# Amphenol®/Pyle®/Matrix® Quick Product Guide

## EMI Filter/Transient Protection Devices

### Intermateable with/Features of

FTV - MIL-DTL-38999 Series III  
FJT - MIL-DTL-38999/27599 Series II  
FLJT - MIL-DTL 38999/27599 Series I  
FSJT - Proprietary SJT  
FBL - MIL-DTL-38999 Series IV  
FPT - MIL-DTL-26482 Series 1 & 2  
- MIL-DTL-83723 Series I

### Other EMI/Transient Protection

MOV's                      Hermetic Filters  
Diodes                     Filter Adapters  
EMP                        Filtered Plugs  
"AN" Filters

Amphenol Canada Filter Products:  
485 Series Filtered ARINC 404 & 600  
MIL-DTL-24308 Filter D-Subs  
MIL-DTL-83513 Micro D-Subs

## Fiber Optic Products

### Fiber Optic Termini:

MIL-PRF-29504/4 & /5 Multi-mode size 16  
Multi-mode, HD20  
MIL-PRF-20504/4 & /5 Single mode size 16  
90° Multi-mode size 16  
ARINC 801  
MT ferrule

### Fiber Optic Cylindrical Connectors -

**Tri-Start, MIL-DTL-38999 Series III**  
Incorporating MIL-PRF-29504 or ARINC 801 or  
MT termini

Fiber Optic Bulkhead Feed-through

### Fiber Optic Rectangular Connectors:

PCB - Brush & Fiber Optic Combinations  
LRM - Brush & Fiber Optic Combinations  
VMEP0/J0, Ruggedized VITA-46

### Fiber Optic Rack & Panel Connectors:

ARINC 600, R27 and R58 Series

### Other Fiber Optic Products

Fiber Optic Cable Systems  
MFM Family: Hermaphroditic, Duplex, Simplex  
TFOCA-II  
CTOS, CTOL, AXOS Field Deployable Lens  
ST Fiber Optics  
MIL-PRF-NGCON  
MTRJ Field  
Tactical Optical Splice  
Fiber Optic Termination Tools

## Printed Circuit Boards and Flex Circuitry

Design formats of Mentor, PADS, Cadence,  
Zuken. Panel thickness: .500"  
Panel Sizes: 24" x 54", 30" x 44", 36" x 42"  
Layer count up to 64  
Interconnect formation types: back drilled,  
dual dia., thru hole, blind, electrically isolated,  
buried, SMT  
Many other options and material choices  
Flexible and Rigid-Flex  
**For attachment to Printed circuit boards:**  
Press fit connectors  
Cylindricals with PC Tail contacts  
Universal Header Assemblies  
Flex Circuit Assemblies  
Printed Circuit Bd. Terminal Blocks  
Wiring Interface Modules

## Board Level Rectangular Connectors

### MIL-DTL-55302

#### with Bristle Brush Contacts

M55302/166	MB ( )-( )P
M55302/167	MB ( )-( )W
M55302/168	PC ( )-( )P
M55302/169	IO ( )-( )C
M55302/169	IO ( )-( )P
M55302/170	DB ( )-( )P

### MIL-DTL-55302

#### with Crimp, Solder or PCB Contacts

M55302/67-69	PCB90A
M55302/70-71	PCB100A
M55302/76-77	PCB100B
M55302/74-75	PCB100C
M55302/72-73	PCB150A

### High Density Rectangular Connectors

HDB<sup>3</sup> Mother Board/Daughter Board  
HiLinX  
Viper

### LRM Surface Mount

#### with Bristle Brush Contacts

Module and Backplane connectors with  
standard Brush contacts  
Staggered Grid - 180 contact pattern grid  
GEN-X Grid - 236 contact pattern grid  
SEM-E or custom form factors  
Air-flow inserts for wider boards  
LRM can incorporate Fiber Optics,  
RF contacts, shielded high speed contacts,  
in combinations with Brush contacts  
LRM with flex circuitry  
LRM power supply modules

### VME Rectangular Products

Ruggedized VME64-X  
Ruggedized VME P0/J0

### Backplane Connectors

#### with Tuning Fork & Blade Contacts

UHD (Ultra High Density) Connectors  
NAFI (Daughtercard/Backplane Conn.)

### Other Rectangular Connectors

I/O NAFI Series  
LMD and LMS Modules  
Amphenol AirLB SIM Modulators  
SIHD, SIAL Interconnects  
VITA -46  
Heat Sink Manufacturing  
Amphenol Canada products: R39, R58  
and SD308, CD308

### Backplane Systems

Electrical and Optical Backplane Systems that  
can incorporate:  
MIL-DTL-55302 brush contacts  
NAFI fork and blade contacts  
UHD fork and blade  
ARINC  
MIL-DTL-38999 Cylindricals  
MT Optical Ferrules

### Rack & Panel Connectors

#### Rectangular Rack and Panel:

Ruggedized, Non-Floating Brush  
LPSRC, SR  
217 Series  
LE, LPX Series  
ARINC 404, ARINC 600  
R27 Series  
RFM Modular Series  
Micro D-Subs

#### Cylindrical Rack and Panel:

RNJ Series

## Special Purpose Interconnection Products

### Hermetics

Available in the following series:  
MS Standard MIL-DTL-5015  
Miniature MIL-DTL-26482  
Subminiature MIL-DTL-38999, I, II, III

### Breakaway/Lanyard Release

Available in the following series:  
Fail-Safe Subminiature MIL-DTL-38999  
Twist-Pull Miniature MIL-DTL-26482  
Quick Disconnect Matrix MIL-DTL-83723  
Quick Disconnect Matrix MIL-DTL-5015  
Stores Management Type II, Rail Launch  
1760 Weapons Release  
Gatelink Breakaway

### Battlefield Interconnects & Cables

Stinger Missile types  
EMC Protected & Over-molded Cable  
Singcars, Bowman Program Connectors  
Wind Corrected Munitions Dispenser

### Rail Mass Transit/Industrial Interconnects & Cables

Freight-Mate Cable Assemblies  
Trans-Power & 27 Pole Train-Line  
Over-molded Cable available with any  
Amphenol cylindrical industrial connector

### Data Bus Products

Can Couplers, Box Couplers  
ARINC 629 Current Mode Couplers  
Wire Integrated Connectors (W.I.C.s)  
711 Data Bus

### Other Special Purpose Products

RJ Field, USB Field, MTRJ Field, EZ Field  
Amphenol Nexus Technologies Products  
for Audio Frequency Protection  
SV Microwave Connectors  
Aquacon Immersible  
Pyle Pon Series Indicator Lights  
WFRS Interlocked Safety Switches  
Astronaut Zero-G Connectors  
PMAT (ARINC 644)  
Geophysical Miniatures  
SCE and Mini SCE Push Pull  
PPM Push-Pull  
Shorting Plugs  
Micro-Miniature Connectors  
ECTA 133, ECTA 544  
Quick Connection Modules  
1900 Rectangulars  
AT Series Circular J1939 Diagnostic.

## Contacts and Accessories

Crimp M39029, Thermocouple, Wire wrap,  
Coaxial, Twinax, Triax, Quadax and  
Differential Twinax Shielded Contacts  
Bristle Brush Contacts for Rectangulars  
Fork & Blade Contacts for Rectangulars  
Fiber Optic Termini  
RADSOX® Contacts for High Amperage  
High Frequency Contacts with "Float  
Mount Technology  
AT Series Contacts  
M85049 Accessories  
Backshells  
Industrial Cord Grips and Cable Glands  
Pipe & Cable Supports  
Relay Sockets and Junction Modules

We invite you to visit our websites where you  
can find product catalogs that can be down-  
loaded and printed. Catalogs will be added  
and updated on an on-going basis.

[www.amphenol-aerospace.com](http://www.amphenol-aerospace.com)  
[www.amphenol-industrial.com](http://www.amphenol-industrial.com)  
[www.amphenol-abs](http://www.amphenol-abs)

# SECTION VII

## Know the Language

### Common terms you should know

(listed alphabetically)

- **Accessories** - Mechanical devices, such as cable added to connector shells and other such hardware that are attachable to connectors to make up the total connector configuration; while providing wire support and/or wire sealing
- **Bayonet Coupling** - A non-threaded, ramp type of coupling
- **Cable Assembly** - A cable with plugs or connectors on each end
- **Configuration** - Arrangement of contacts in a multiple-contact connector
- **Contacts** - Mechanical component to which electrical engagement is accomplished
- **Contact Size - (Also known as Wire Gauge)** - the largest wire that can be used with a specific contact
- **Contact Spacing** - The distance between the center-lines of adjacent contact areas.
- **Coupling Nut** - Outer threaded or grooved ring which holds mated pair together
- **Crimp Contact** - A contact to which wire is joined by mechanical squeeze
- **EMI or RFI Backshell** - A type of accessory to terminate wire shielding
- **Environmentally Sealed** - Connector provided with gaskets, seals, potting or other devices to keep out moisture, dirt, air or dust that might reduce its performance
- **Extraction/Removal Tool** - A handheld tool used for removing a contact from a connector.
- **Fiber Optic Termini** - Comparable to electrical pin and socket contacts, except they transmit data optically through fibers instead of electrically through wires.
- **Gland** - Resilient ring in rear accessory, provides seal on jacketed cable
- **Grounding Fingers** - A metal strap around plug shell for positive shell-to-shell conductivity/shielding
- **Grommet** - Resilient part at back of insert (attached or separate); gives wire moisture seal
- **Hermetic** - A connector with fused glass insert for air tightness



### Connector:

A device providing electrical or signal connection. It consists of a plug and receptacle.

- **Insert** - The dielectric or insulating inner core, holds contacts
- **Insert Arrangement** - The number, spacing and arrangement of contacts in a connector
- **Insertion Tool** - A small, handheld tool used to insert contacts into a connector
- **Interfacial Seal** - A resilient part on the face of pin inserts which provides moisture seal.
- **Jam Nut** - Hex nut that holds receptacle to a panel
- **Mating Pair** - Two connectors that couple together. Shell size insert arrangement and rotation must be compatible
- **Mating/Unmating Forces** - Torque required to couple/uncouple a mating pair of connectors or contacts
- **“O” Ring** - Doughnut-shaped ring of rubber used as a seal around the mating insulator interface of cylindrical connectors
- **Pin Contact** - Male half of a mated pair of contacts\*
- **Plating** - The metal finish applied to contacts and or shell components (protective) to resist corrosion and wear
- **Plug** - The cable/coupling half of a mating pair
- **Potting Boot** - A type of accessory which forms a mold for potting compound
- **Rear Termination** - An accessory which threads to back of shell
- **Receptacle** - The panel/receiving half of a mating pair
- **Sealing Plug** - Plastic type slug, placed in unused grommet holes to seal
- **Service Rating (Also known as Current Rating)** - The maximum voltage or current that a connector is designed to carry continuously.
- **Shell** - Houses insert and contacts
- **Socket Contact** - Female half of a mated pair of contacts
- **Solder Contact** - A contact to which wire is joined by soldering. Has a cup, hollow cylinder, eyelet or hook to accept a wire for conventional soldered termination.
- **Strain Relief (Also known as Cable Clamp)** - A type of accessory which clamps wires for support

\*Note: Male half always goes into female.

# SECTION VII

## Know the Language - Other Interconnection Product Terms

- **Alternate Rotations** - In cylindrical connectors: Rotation of either an insert or designated key/keyway locations (Alternate Keying) in a connector shell to a different angle than normal position. Allows for variations of mating two halves of cylindrical connectors.
- **Anodize** - Formation of a protective, insulating oxide layer on metal bay electrolytic action.
- **Arc Resistance** - The characteristic of insulating materials to resist carbonization (also known as tracking) of the material surface between electrodes resulting from voltage breakdown.
- **Attenuation** - (this term is used in Filters) The ratio of the input to output power levels in a network (transmission line) when it is excited by a matched source and terminated in a matched load.
- **Back-mounted** - When a connector is mounted from the inside of a panel or box with its mounting flanges inside the equipment.
- **Circuit** - A complete path or electron flow from a negative terminal of voltage source through a conductor and back to the positive terminal.
- **Closed Entry Socket Contacts** - A female contact designed to prevent the entry of a pin or probing device having a cross-sectional dimension greater than the mating pin.
- **Coaxial Cable** - A high-bandwidth cable consisting of two concentric cylindrical conductors with a common axis that is used for high speed data communication and video signals.
- **Compliant Contact** - A press-fit type contact used to attach to a printed circuit board. Has an eyelet end.
- **Conductivity** - The ability of a material to conduct electric current, expressed in terms of the current per unit of applied voltage. It is reciprocal of resistivity.
- **Contact Durability** - Endurance measured by the number of insertion and withdrawal cycles that a connector withstands remaining within its specified performance level.
- **Contact Engaging and Separating Force** - Force needed to either engage or separate pins and sockets when they are out of connector inserts. Values are generally established for maximum and minimum forces.
- **Contact Resistance** - Maximum permitted electrical resistance of pin and socket contacts when assembled in a connector under typical service use.
- **Contact Retention** - The minimum axial load in either direction that a contact must withstand while remaining firmly fixed in its normal position within the connector insert or housing.
- **Continuity** - A continuous path for the flow of current in an electrical circuit.
- **Corrosion** - The destruction of the surface of a metal by chemical reaction.
- **Coupling Torque** - Force required to rotate a coupling ring or jackscrew when engaging a mating pair of connectors.
- **Diallyl Phthalate (DAP)** - (Blue insert in 97 Series) A thermo-setting plastic that offers outstanding dimensional stability and resistance to most chemicals and chemical compounds.
- **Dielectric** - Any insulating medium that intervenes between two conductors.

- **Dielectric Withstanding Voltage** - Maximum potential gradient that a dielectric material can withstand without failure.
- **Discontinuity** - A broken connection or the loss of a specific connection characteristic.
- **Edge Connector** - One piece receptacle, containing female contacts designed to receive the edge of a printed circuit board and interconnect on which the male contacts are etched or printed. The connector may contain either a single or double row of female contacts.
- **Edgeboard Connector** - A connector that mates with printed wiring leads running to edge of a PC board.
- **Feed-through** - A conductor that connects patterns on opposite sides of a PC board. Also called interfacial connection.
- **Fiber Optics** - A data transmission medium consisting of glass fibers. Light-emitting diodes send light through the fiber to a detector, which then converts the light back into electrical signals.
- **First Article** - A sample part or assembly manufactured prior to the start of production for the purpose of assuring that the manufacturer is capable of manufacturing a product that will meet the requirements.
- **Front-mounted** - A connector is front-mounted when it is attached to the outside or mating side of a panel. (Can only be installed or removed from the outside of the equipment.
- **Front Release Contacts** - Connector contacts are released from the front side of the connector and then removed from the back wire side of the connector. The removal tool engages the front portion of the contact and pushes it out the back where it is removed by hand.
- **Harsh or Hostile Environment Connector** - A connector designed and engineered for operation in hostile environment conditions, such as extreme high temperatures of 677°C (1,250°F), extreme low temperatures of absolute zero and severe water tight conditions.
- **Header** - A feed through device that introduces a conductive path through an insulating plate.
- **Hermaphroditic Connector** - Interconnecting device in which both mating parts are identical at their mating surfaces. (Also called Sexless Connector)
- **Hermaphroditic Contact** - A contact in which both mating elements are precisely alike at their mating face.
- **Input/Output Connector** - A mating pair of connectors used to carry signals into and out of a panel-mounted subsystem. An example is connector pair that interconnects the individual back panels in a large array of panels.
- **Insert Retention** - Axial load in either direction that an insert must withstand without being dislocated from its normal position in the connector shell.
- **Insertion Force** - The effort, usually measured in ounces, required to engage mating components.
- **Interchangeable** - Characteristic of connectors in which one manufacturer's connector can be replaced by the connector of another manufacturer and provide the same function in the same panel space as the connector it is replacing.
- **Intermateable** - Characteristic of connectors in which a connector half manufactured by one connector will mate directly with a connector half manufactured by a different company



# SECTION VII

## Know the Language - Other Interconnection Product Terms

- **.Keying** - Mechanical arrangement of guide pins and sockets, keying plugs, contacts, bosses, slots, keyways, inserts or grooves in a connector housing, shell or insert that allows connectors of the same size and type to be lined up without the danger of making a wrong connection.
- **Lanyard** - A device attached to certain connectors that permit uncoupling and separation of connector halves by a pull on a wire or cable.
- **Life Cycle** - A test that indicates the time span before failure; the test occurs in a controlled, usually accelerated, environment.
- **Mass Termination** - Method of termination in which terminals that pierce flat cable insulation without stripping to cold flow mate with conductors and form a metal-to-metal joint.
- **Motherboard** - A printed board used for interconnecting arrays of plug-in electronic modules.
- **Operating Temperature** - Maximum internal temperature-resistant capabilities of a connector in continuous service.
- **Outgassing** - De-aeration or other gaseous emission from a printed board assembly (printed board, component of connector) when exposed to a reduced pressure or heat, or both.
- **Panel-mount** - Fixing a connector half to a board, panel or frame. Usually, the female portion of the connector is mounted, and the male half is the removable portion.
- **Plated Through-Hole** - A hole-formed deposition of metal on the sides of the hole and on both sides of the base to provide electrical connection from the conductive pattern on one side to that on the opposite side of the PC board.
- **Poke-Home Contact** - Term applied to a male or female contact to which a wire has been permanently affixed prior to the assembly of the contact into the insert.
- **Positioner** - Device attached to the crimping tool to position conductor barrels between the indentors.
- **Potting** - Sealing of a component (for example the cable end of a multiple contact connector) with a plastic compound or material to exclude moisture, prevent short circuits and provide strain relief.
- **Pre-tinned** - Solder applied to an electrical component prior to soldering.
- **Pre-tinned Solder Cup** - Solder cups with inner surfaces that have been pre-coated with a small amount of tin lead solder or RoHs approved solder.
- **Press-fit Contact** - Either a solid pin or a pin having a compliant member that makes an interference connection with a through-hole on a PC board. The pressure developed between interconnecting surfaces is sufficient to provide gas-tight electrical reliability without the use of solder.
- **Qualified Products List (QPL)** - A list of commercial products that have been pretested and found to meet the requirements of a specification, especially government specifications.
- **Quick-disconnect Coupling** - A design feature, apparent in the quick-disconnect connector; it permits relatively rapid joining and separation.
- **RADSOK® Contact\*** - A unique socket contact design with a stamped and formed twisted inner grid. Socket cylinder within the female contact has several equally spaced longitudinal beams twisted into a hyperbolic shape. As male pin is inserted, axial members in the female half deflect, imparting high current flow across the connections.
- **Ramp** - The sloped channel that accepts the detent pin in a bayonet connector.
- **Rear Release Contacts** - Connector contacts are released and removed from the rear (wire side) of the connector. The removal tool engages the contact from the rear and pulls the contact out of the connector contact retainer.
- **Rear Seal** - Design feature that provides an environmental seal at the rear of plug or receptacle.
- **Removable Contact** - A contact that can be mechanically joined to or removed from an insert. Usually, special tools are required to lock the contact in place or remove it for repair or replacement.
- **RoHS (Restrictions of Hazardous Substances)** - The RoHS Directive bans the placing on the EU market of new electrical and electronic equipment containing more than agreed levels of lead, cadmium, mercury, hexavalent chromium, polybrominated biphenyl (PBB) and polybrominated diphenyl ether (PBDE) flame retardants.
- **Scoop Proof** - Design feature whereby exposed contacts of a connector cannot be touched or damaged by any portion of the mating connector.
- **Serrations** - Small grooves or indentations within a terminal wire barrel that increase the tensile strength and electrical conductivity of the crimped termination.
- **Soldering** - Process of joining metallic surfaces with solder, without the melting of the base metals. Soldering is an economical, versatile and fast termination method. A soldered connection has metallic continuity and excellent long term reliability.
- **Splice Connector** - A joint connecting conductors with good mechanical strength and good conductivity; a terminal that permanently joins two or more wires.
- **Surface Mounting** - The electrical connection of components to the surface of a conductive pattern without utilizing component holes.
- **Thermal Shock** - The effect of heat or cold applied to a material at such a rate that non-uniform thermal expansion or contraction occur. In connectors, the effect can cause inserts and other insulation materials to pull away from metal parts.
- **Thermocouple Contact** - A contact of special material used in connectors employed in thermocouple applications. Materials often used are iron, constantan, copper, chromel and alumel.
- **Tuning Fork Contact** - U-shaped female contact that resembles a tuning fork. It can be stamped or formed.
- **Umbilical Connector** - A connector used to connect cables to a rocket or missile prior to launching, and which is removed from the missile at the time of launching.
- **Wire-Wrapped Connection (Also known as Solderless Wrap)** - A solderless connection made by wrapping bare wire around a square or rectangular terminal with a power or hand tool.

# SECTION VII, cont.

## Basic Questions to Determine Connector Requirements

- **How many conductors (wires) and what are the wire gauges (size)?**

Smallest contact sizes available by Military Specifications:

MIL-DTL-5015 - size 16  
MIL-DTL-22992 - size 16  
MIL-DTL-26482 - size 20  
MIL-DTL-38999 - size 22D

- **What's your working voltage requirement?**

See catalog insert arrangement table  
Catalog 12-024 ....GT Reverse Bayonet  
Catalog 12-020 ....MIL-DTL-5015  
Catalog 12-026 ....MIL-DTL-5015 Matrix  
Catalog 12-052 ....MIL-DTL-22992 Class L, QWLD  
Catalog 12-053 ....MIL-DTL-22992 QWL  
Catalog 12-070 ....MIL-DTL-26482, Series 1  
Catalog 12-071 ....MIL-DTL-26482, Series 2  
Catalog MS-102...MIL-DTL-83723, Series III Pyle  
Catalog 12-073 ....MIL-DTL-83723, Series III Matrix  
Catalog 12-090\*...MIL-DTL-38999, Series I, II  
Catalog 12-092\*...MIL-DTL-38999, Series III

- **Are you using your connector in a benign environment or a harsh environment?**

Harsh environment - will need gaskets, grommets and/or glands for environmental sealing

- **Do you want to Solder or Crimp your wires?**

- **Are you going cable to cable or cable to panel?**

Cable plug to Cable receptacle use:  
– Straight plug with Inline cable receptacle  
– 90° Plug with Inline cable receptacle

Cable plug to Panel receptacle use:

– Straight plug with either a wall mount receptacle, box mount receptacle, or jam nut receptacle  
– 90° plug with either a wall mount receptacle, box mount receptacle, or jam nut receptacle

- **What's your cable outer diameter (OD)? Or are you using discrete wires?**

- **Do you have any material restrictions?**

– RoHS requirement  
– Stainless steel  
– Aluminum  
– Neoprene  
– Silicon  
– Viton

- **What type of plating or finish is preferred?**

Common platings or finishes:

– Olive drab cadmium  
– Nickel  
– Black zinc alloy  
– Electroless nickel  
– Anodic coating

- **Will you need accessories?**

– Cable clamp  
– Bushing  
– Protection caps (metal or plastic)  
– Dummy receptacle

- **Are you using an electrical or signal connector?**

### POWER

MIL-DTL-5015 and Amphenol GT Reverse Bayonet  
– Standard contacts or (High Amperage) RADSOK®  
MIL-DTL-22992  
MIL-DTL-26482  
MIL-DTL-38999 Series I, II, III

Hermetic

MIL-DTL-26482  
MIL-DTL-83723  
MIL-DTL-38999 Series I, II, III

### SIGNAL

MIL-DTL-5015  
– High Frequency contacts  
MIL-DTL-22992  
– High Frequency contacts  
MIL-DTL-38999, Series I, II, III  
– High Frequency contacts  
– Fiber Optics  
Brush Technology  
– Rectangular PCB  
– LRM  
– Fiber Optics

Filter

MIL-DTL-38999 Series I, II, III  
MIL-DTL-26482

Hermetic

MIL-DTL-26482  
MIL-DTL-83723  
MIL-DTL-38999 Series I, II, III

\* Catalog 12-C1 combined catalog for 38999 Series I, II and III Connectors will replace catalog 12-090 (Series I, II) and catalog 12-092 (Series III). Consult Amphenol Aerospace for the availability of this new catalog.

NOTE: Socket contacts are to be used in the connector feeding the power

NOTE: Not all connectors are limited to solely either power or signal. Many connectors can perform both functions.

# SECTION VII, cont.

## What do you need to Sell?

### ✓ A Basic Product Knowledge

- Why connectors are needed
- Nomenclature (component parts)
- Typical terms or descriptive words
- Pertinent references to MIL-Spec
- Cross reference Amphenol P/N to MIL P/N

### ✓ A Catalog

- Know how it is organized
- Keep it current
- Add your own notes for reference

### ✓ Know Our Websites

[www.amphenol-aerospace.com](http://www.amphenol-aerospace.com)

[www.amphenol-industrial.com](http://www.amphenol-industrial.com)

- Quickly navigate on-line to -
  - Connector Catalogs
  - Service Instructions
  - Your Contact Information
  - Markets Served
- Connector Basics has this brochure and other valuable basic connector information
- Amphenol One for Distributor Information and Latest Product News

### ✓ Know Your Organization and Ours

- Who has pricing & delivery data
- Who has technical data
- Who can expedite
- Who can negotiate
- A back up for each of the above

### ✓ Know Yourself and Your Competitors

- What is negotiable at your account
- What are your strong points
- What are your weak points
- What are your protection points
- Who is your competition

### ✓ Know Your Customers

- What are their Needs?
- Company Needs – Personal Needs

### ✓ Learn to Listen (and to See)

- What are they saying?
- What do they mean?
  - How they say it may mean more than what they say
  - What you both see may say more than conversation

### ✓ Each account is unique

- Don't use a carbon copy approach
- Let your customers know you see them that way

### ✓ Take time to know the people you deal with

- Both at your account and your facility
- Manage your time and territory like assets
- If business or potential isn't there, maybe you shouldn't be

## Conclusion

The data in this booklet was designed to provide you with basic information on Amphenol connector products.

In order to effectively sell, it is important to remember that knowing your customer and your product go hand in hand. The sale begins with you!

We have a great line, you can sell on the quality that it is. Don't promise more than you can deliver, simply tell it like it is. You may lose some sales, but your credibility will grow.



## X-ON Electronics

Largest Supplier of Electrical and Electronic Components

*Click to view similar products for* [Circular MIL Spec Tools, Hardware & Accessories](#) *category:*

*Click to view products by* [Amphenol](#) *manufacturer:*

Other Similar products are found below :

[0113-201-2025](#) [600-079-06](#) [600-146-06](#) [M10-101983-183](#) [M10-454396-008](#) [602GB18808](#) [CS3102A-22-14PW](#) [M2887615-CD](#) [627-009](#)  
[M38999/9-19B](#) [630A007NF083A](#) [630B007M051A](#) [630BJ003NF032H](#) [637-149NF04B](#) [M39029/29-215](#) [6408-203V-09273](#) [6426-201-11343](#)  
[650FS002NF16](#) [660-008NF14S7-01](#) [660-009M22H8-03](#) [660-013NF19U6-210](#) [660-015M10S6-17](#) [660-015NF10S5-01](#) [660-015NF14R3.5-01](#)  
[660-023NF19H6-19](#) [660-024NF11S12-01](#) [660-024NF11S3-01](#) [660-024NF17S4-109](#) [660-050XM17F4-01](#) [660-068NF25R6-30G](#) [660-](#)  
[070M23S8-04](#) [660-073MTCH9-20](#) [M83723/61-18W](#) [M83723/61-218R](#) [M83723/61-224W](#) [667-084-23C](#) [667-084-35C](#) [667-224NF16](#) [687-](#)  
[697NF-1](#) [M85049/94-10-A](#) [M85049/96-7-A](#) [M855282-10A01A](#) [M85528/2-10B](#) [M855282-18A01A](#) [M85528/2-22A01A](#) [M85528/2-22AA](#)  
[710HS460NF2508](#) [780-001-22G12-SK](#) [780-002-19G12-SK](#) [780-002-20G12SK](#)