

THIS DOCUMENT IS SUBJECT TO CHANGE WITHOUT NOTICE. IT IS CONFIDENTIAL AND A PROPERTY OF Amphenol LTW. DISCLOSURE TO THIRD PARTY HAS TO BE AUTHORIZED BY Amphenol LTW.

REV.	ECN NO.	DATE	SIGN	DESCRIPTION
A	Initiale Release	2015/07/18	Cary	Change Rev.01 To Rev.A
B	LEN1580223~234	2015/08/10	Feng_Li	Add Black PVC Cable
C	LEN1680626~643	2016/08/11	Yulong_wang	Add 6Pin & IP69K.

F
E
D
C
B
A

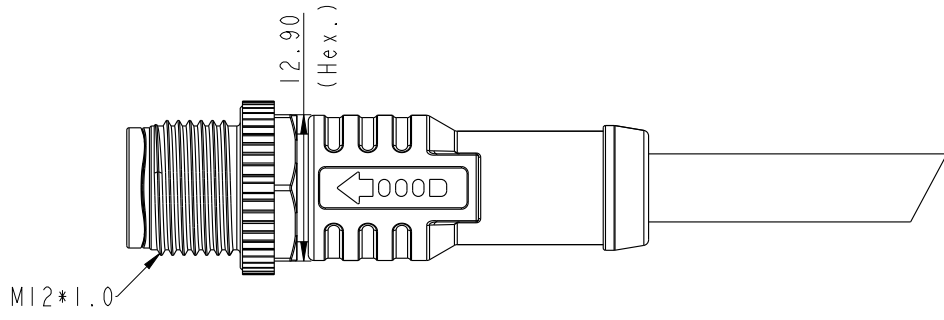
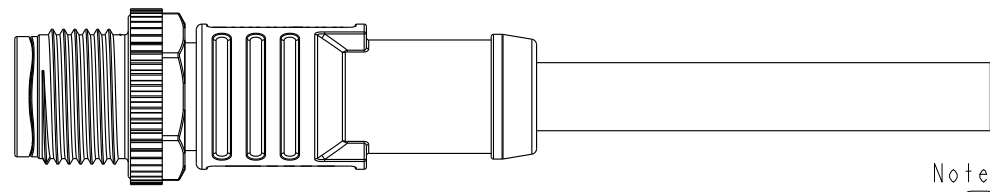
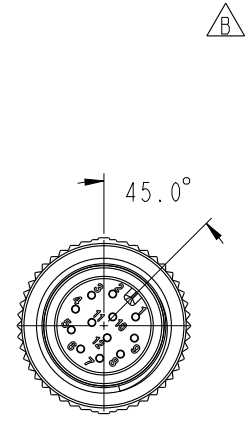
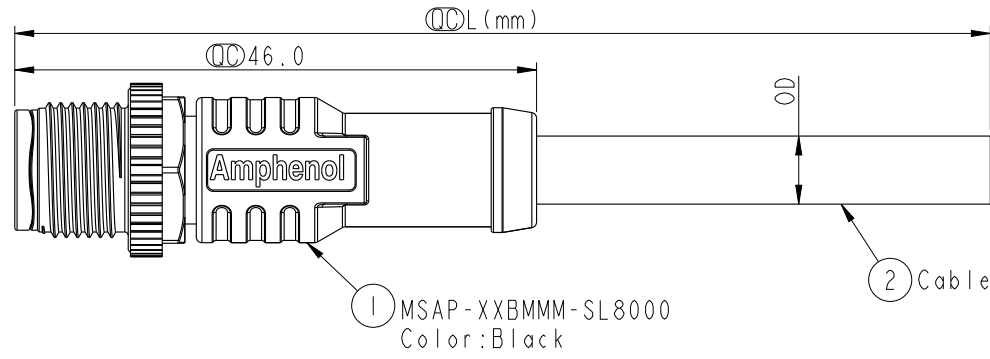

- Notes:
- * \varnothing Important Dimension.
 - * $\triangle C$ Waterproof Rate: IP68, IP69K.
 - * Connector: PU+GF,Black.
 - * Male Pin: Copper Alloy, Gold Plated.
 - * $\triangle B$ Screw Nut:Nylon,Black.
 - * $\triangle A$ Outer Mold: PU,Black.
 - * $\triangle B$ Cable: (A) UL2517,PVC Jacket,Yellow.
(B) UL20549,PUR Jacket,Black.
(D) UL2517,PVC Jacket,Black.
 - * Rated Voltage: 3 & 4Pin 250V dc. or ac.
5Pin 60V dc. or ac.
6~12Pin 30V dc. or ac.
 - * Rated Current: 3~5Pin 4A
6~8Pin 2A
10~12Pin 1.5A
 - * Operating Temperature: -25~85°C
 - * Cable Length Tolerance: 01M:±40mm
02M~05M:±60mm
06M~10M:±100mm
11M~30M:±200mm

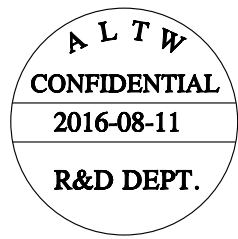

UNIT:mm		
TOLERANCE		
±0.5mm		

TITLE M12 A Type Cable Male Conn.		
SCALE 3:2	SIZE A4	SHEET 1 OF 3
REV. C	WC-REV. A.1	\varnothing : Inspection item

Amphenol LTW
安費諾亮泰企業股份有限公司

ITEM NO	DRAWN BY Yulong_wang	DATE 2016-08-11
DWG NO MSAP-XXBMMM-SL8XXX	CHECKED BY Jinhai	DATE 2016-08-11
CUSTOMER ALTW	APPROVED BY Jerry	DATE 2016-08-11

THIS DOCUMENT IS SUBJECT TO CHANGE WITHOUT NOTICE. IT IS CONFIDENTIAL AND A PROPERTY OF Amphenol LTW. DISCLOSURE TO THIRD PARTY HAS TO BE AUTHORIZED BY Amphenol LTW.

1 2 3 4 5 6 7 8

△B	12P	PVC	6.0	26	MSAP-12BMMM-SL8DXX		
	10P				MSAP-10BMMM-SL8DXX		
△C	8P		5.5	24	MSAP-08BMMM-SL8DXX		
	6P				MSAP-06BMMM-SL8DXX		
	5P		5.1	22	MSAP-05BMMM-SL8DXX		
	4P				MSAP-04BMMM-SL8DXX		
	3P				MSAP-03BMMM-SL8DXX		
	12P		PUR	6.0	26	MSAP-12BMMM-SL8BXX	
	10P					MSAP-10BMMM-SL8BXX	
	8P			5.5	24	MSAP-08BMMM-SL8BXX	
6P	MSAP-06BMMM-SL8BXX						
△C	5P	5.1		22	MSAP-05BMMM-SL8BXX		
	4P				MSAP-04BMMM-SL8BXX		
	3P	4.5	22	MSAP-03BMMM-SL8BXX			
	12P			PVC	6.0	26	MSAP-12BMMM-SL8AXX
	10P						MSAP-10BMMM-SL8AXX
△C	8P	5.5	24		MSAP-08BMMM-SL8AXX		
	6P				MSAP-06BMMM-SL8AXX		
	5P	5.1	22		MSAP-05BMMM-SL8AXX		
	4P				MSAP-04BMMM-SL8AXX		
	3P			MSAP-03BMMM-SL8AXX			
Contacts	Cable Jacket	Cable OD	AWG	Item No.			

F
E
D
C
B
A

M SAP - XX B M M M - S L 8 X XX

SAP: A-Code Plastic Nut

03: 3Pin
04: 4Pin
05: 5Pin
06: 6Pin △C
08: 8Pin
10: 10Pin
12: 12Pin

B: Cable Without S/R (線端無網尾)
M: Male Connector (公座)
M: Male Pin (公Pin)

XX: 01~99Meters
01: 01Meter
02: 02Meters
:
99: 99Meters

A: PVC UL2517 Cable, Yellow (PVC 黃色外被線材)
△B: PUR UL20549 Cable, Black (PUR 黑色外被線材)
D: PVC UL2517 Cable, Black (PVC 黑色外被線材)

8: IP68/69K (防水等級68/69K) △C

L: Straight (180° 線端)
S: Screw (螺紋式)
M: Molding Type (射出成型)

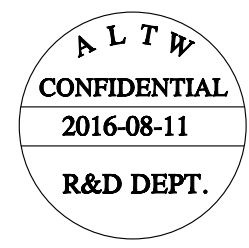

UNIT: mm

TOLERANCE ±0.5mm

TITLE: M12 A Type Cable Male Conn.

SCALE: 3:2 SIZE: A4 SHEET: 2 OF 3

REV: C WC-REV: A.1

Amphenol LTW
安費諾亮泰企業股份有限公司

ITEM NO	DRAWN BY	DATE
DWG NO	CHECKED BY	DATE
CUSTOMER	APPROVED BY	DATE
MSAP-XXBMMM-SL8XXX	Yulong_wang	2016-08-11
ALTW	Jinhai	2016-08-11
	Jerry	2016-08-11

THIS DOCUMENT IS SUBJECT TO CHANGE WITHOUT NOTICE. IT IS CONFIDENTIAL AND A PROPERTY OF Amphenol LTW. DISCLOSURE TO THIRD PARTY HAS TO BE AUTHORIZED BY Amphenol LTW.

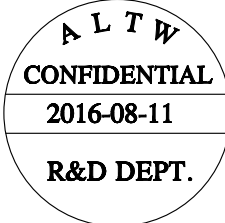

5	--		5	--		5	Gray	灰	5	--		12	--		12	Red/Blue	紅/藍
4	Black	黑	4	Black	黑	4	Black	黑	4	Black	黑	11	--		11	Gray/Pink	灰/粉
3	Blue	藍	3	Blue	藍	3	Blue	藍	3	Blue	藍	10	Violet	紫	10	Violet	紫
2	--		2	White	白	2	White	白	2	White	白	9	Black	黑	9	Black	黑
1	Brown	棕	1	Brown	棕	1	Brown	棕	1	White	白	8	Red	紅	8	Red	紅
												7	Blue	藍	7	Blue	藍
												6	Pink	粉	6	Pink	粉
												5	Gray	灰	5	Gray	灰
												4	Yellow	黃	4	Yellow	黃
												3	Green	綠	3	Green	綠
												2	Brown	棕	2	Brown	棕
												1	White	白	1	White	白
Pin #	Wire		Pin #	Wire		Pin #	Wire		Pin #	Wire		Pin #	Wire		Pin #	Wire	

Pin Out

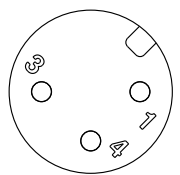

3P

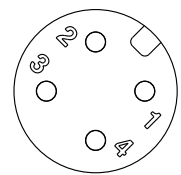

4P

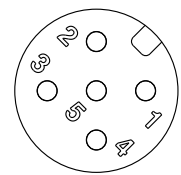

5P

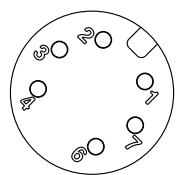

6P

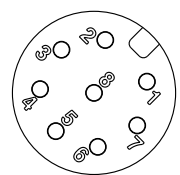

8P

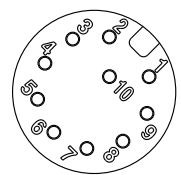

10P

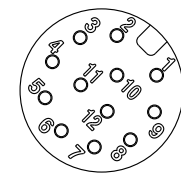

12P

Pin Assignments Front View

UNIT:mm TOLERANCE ±0.5mm	TITLE M12 A Type Cable Male Conn.		<h1>Amphenol LTW</h1> <p>安費諾亮泰企業股份有限公司</p>	ITEM NO	DRAWN BY Yulong_wang	DATE 2016-08-11	
	SCALE 3:2	SIZE A4		SHEET 3 OF 3	DWG NO MSAP-XXBMMM-SL8XXX	CHECKED BY Jinhai	DATE 2016-08-11
	REV. C	WC-REV. A.1		☉: Inspection item	CUSTOMER ALTW	APPROVED BY Jerry	DATE 2016-08-11

X-ON Electronics

Largest Supplier of Electrical and Electronic Components

Click to view similar products for [Sensor Cables / Actuator Cables](#) category:

Click to view products by [Amphenol](#) manufacturer:

Other Similar products are found below :

[60963](#) [60964](#) [M83513/19-F01CP](#) [703000D02F2002](#) [703001D02F0602](#) [703001D02F300](#) [704000D02F120](#) [773032K02F030](#) [802027107404-1](#)
[802027213811-1](#) [804001A09M150](#) [805001A09M0502](#) [84914-0235](#) [84914-0237](#) [885030A09M020](#) [8R4J30E03C3003](#) [1200651332](#)
[1200651713](#) [1200660844](#) [1200660845](#) [1200661173](#) [1200680071](#) [1200720053](#) [1200720081](#) [1200720099](#) [1200720217](#) [1200800231](#)
[1200860125](#) [1200870123](#) [1200980102](#) [1200650267](#) [1200650298](#) [1200660183](#) [1200660782](#) [1200660849](#) [1200661295](#) [1200661297](#)
[1200661342](#) [1200661343](#) [1200670080](#) [1200670220](#) [1200680331](#) [1200720252](#) [1200730184](#) [1200860344](#) [1200870359](#) [1200870643](#)
[1200980008](#) [1200980031](#) [1210502211](#)