

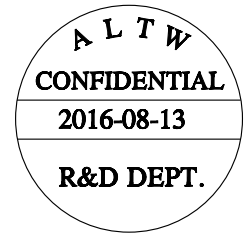

REV.	ECN NO.	DATE	SIGN	DESCRIPTION
B	LEN1580235-246	2015/08/10	Feng_Li	Add Black PVC Cable
C	LEN1680704-721	2016/08/13	Yulong_wang	Add 6Pin & IP69K.

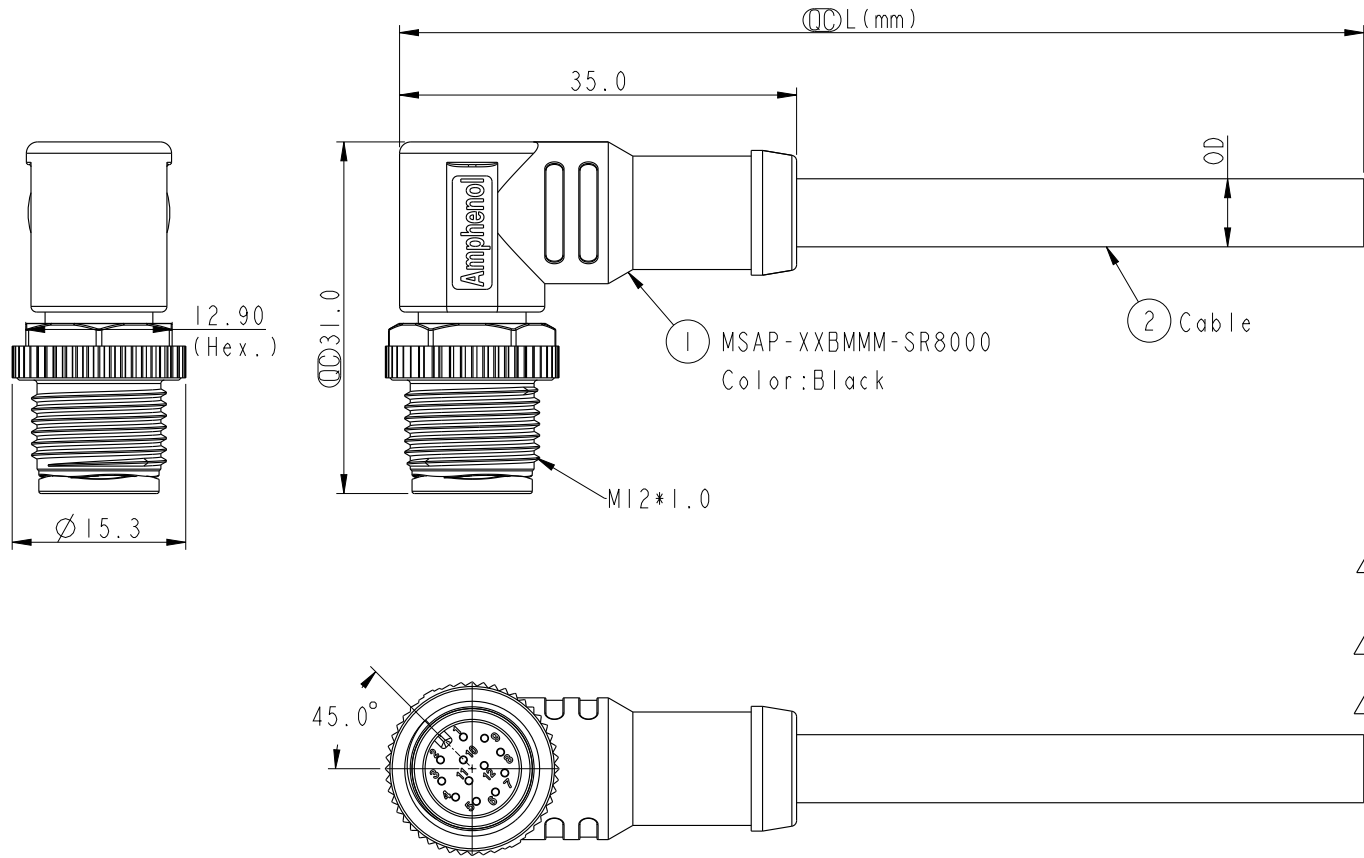

- Notes:
- * \varnothing Important Dimension.
 - * $\triangle C$ Waterproof Rate: IP68, IP69K.
 - * Connector: PU+GF,Black.
 - * Male Pin: Copper Alloy, Gold Plated.
 - * $\triangle B$ Screw Nut:Nylon,Black..
 - * Outer Mold: PU,Black.
 - * $\triangle B$ Cable: (A) UL2517,PVC Jacket,Yellow.
(B) UL20549,PUR Jacket,Black.
(D) UL2517,PVC Jacket,Black.
 - * Rated Voltage: 3 & 4Pin 250V dc. or ac.
5Pin 60V dc. or ac.
6~12Pin 30V dc. or ac.
 - * Rated Current: 3~5Pin 4A
6~8Pin 2A
10~12Pin 1.5A
 - * Operating Temperature: -25~85°C
 - * Cable Length Tolerance: 01M:±40mm
02M~05M:±60mm
06M~10M:±100mm
11M~30M:±200mm

UNIT:mm  
TOLERANCE
±0.5mm

TITLE M12 A Type 90° Male Conn.			
SCALE 3:2	SIZE A4	SHEET 1 OF 3	
REV. C	WC-REV. A.1	\varnothing : Inspection item	

Amphenol LTW
安費諾亮泰企業股份有限公司

ITEM NO	DRAWN BY Yulong_wang	DATE 2016-08-13
DWG NO MSAP-XXBMMM-SR8XXX	CHECKED BY Jinhai	DATE 2016-08-13
CUSTOMER ALTW	APPROVED BY Jerry	DATE 2016-08-13

THIS DOCUMENT IS SUBJECT TO CHANGE WITHOUT NOTICE. IT IS CONFIDENTIAL AND A PROPERTY OF Amphenol LTW. DISCLOSURE TO THIRD PARTY HAS TO BE AUTHORIZED BY Amphenol LTW.

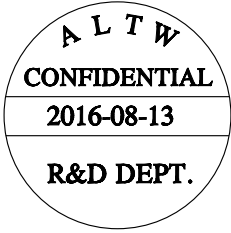

Contacts	Cable Jacket	Cable OD	AWG	Item No.		
△B	PVC	12P	6.0	26	MSAP-12BMMM-SR8DXX	
		10P			MSAP-10BMMM-SR8DXX	
△C		8P	5.5	24	MSAP-08BMMM-SR8DXX	
		6P			MSAP-06BMMM-SR8DXX	
		5P	5.1	22	MSAP-05BMMM-SR8DXX	
		4P			MSAP-04BMMM-SR8DXX	
		3P	4.5	MSAP-03BMMM-SR8DXX		
		△C	PUR	12P	6.0	26
10P				MSAP-10BMMM-SR8BXX		
8P				5.5	24	MSAP-08BMMM-SR8BXX
6P	MSAP-06BMMM-SR8BXX					
5P	5.1			22	MSAP-05BMMM-SR8BXX	
4P					MSAP-04BMMM-SR8BXX	
3P	4.5	MSAP-03BMMM-SR8BXX				
△C	PVC	12P		6.0	26	MSAP-12BMMM-SR8AXX
		10P				MSAP-10BMMM-SR8AXX
		8P		5.5	24	MSAP-08BMMM-SR8AXX
		6P	MSAP-06BMMM-SR8AXX			
		5P	5.1	22	MSAP-05BMMM-SR8AXX	
		4P			MSAP-04BMMM-SR8AXX	
3P		4.5	MSAP-03BMMM-SR8AXX			

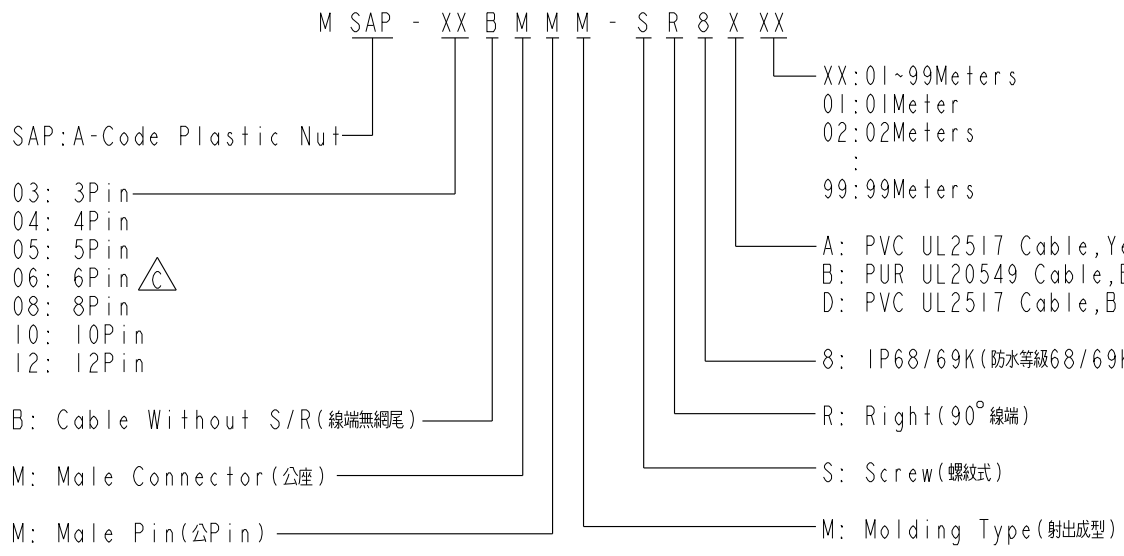

UNIT: mm		TITLE
TOLERANCE	±0.5mm	M12 A Type 90° Male Conn.
SCALE	3:2	SIZE A4
REV.	C	SHEET 2 OF 3
WC-REV.	A.1	QC: Inspection item

Amphenol LTW
安費諾亮泰企業股份有限公司

ITEM NO	DRAWN BY	DATE
DWG NO	CHECKED BY	DATE
CUSTOMER	APPROVED BY	DATE
MSAP-XXBMMM-SR8XXX	Yulong_wang	2016-08-13
ALTW	Jinhai	2016-08-13
	Jerry	2016-08-13

THIS DOCUMENT IS SUBJECT TO CHANGE WITHOUT NOTICE. IT IS CONFIDENTIAL AND A PROPERTY OF Amphenol LTW. DISCLOSURE TO THIRD PARTY HAS TO BE AUTHORIZED BY Amphenol LTW.

THIS DOCUMENT IS SUBJECT TO CHANGE WITHOUT NOTICE. IT IS CONFIDENTIAL AND A PROPERTY OF Amphenol LTW. DISCLOSURE TO THIRD PARTY HAS TO BE AUTHORIZED BY Amphenol LTW.

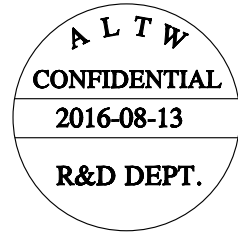

5	--		5	--		5	Gray	灰	5	--		12	--		12	Red/Blue	紅/藍
4	Black	黑	4	Black	黑	4	Black	黑	4	Black	黑	11	--		11	Gray/Pink	灰/粉
3	Blue	藍	3	Blue	藍	3	Blue	藍	3	Blue	藍	10	Violet	紫	10	Violet	紫
2	--		2	White	白	2	White	白	2	White	白	9	Black	黑	9	Black	黑
1	Brown	棕	1	Brown	棕	1	Brown	棕	1	Brown	棕	8	Red	紅	8	Red	紅
												7	Blue	藍	7	Blue	藍
												6	Pink	粉	6	Pink	粉
												5	Gray	灰	5	Gray	灰
												4	Yellow	黃	4	Yellow	黃
												3	Green	綠	3	Green	綠
												2	Brown	棕	2	Brown	棕
												1	White	白	1	White	白
Pin #	Wire		Pin #	Wire		Pin #	Wire		Pin #	Wire		Pin #	Wire		Pin #	Wire	

Pin Out

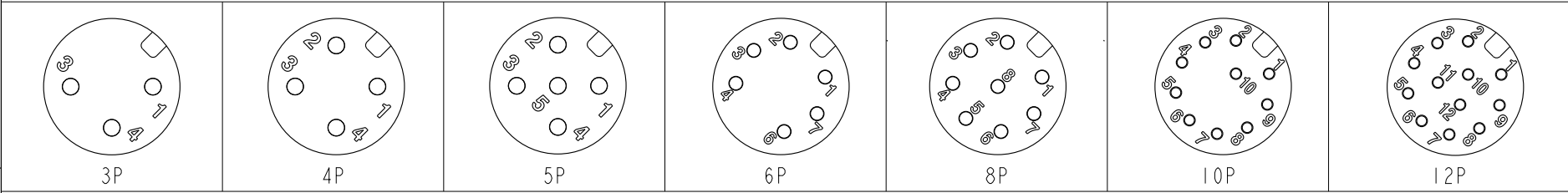

Pin Assignments Front View

UNIT:mm TOLERANCE ±0.5mm	TITLE M12 A Type 90° Male Conn.		<h1>Amphenol LTW</h1> <p>安費諾亮泰企業股份有限公司</p>		ITEM NO	DRAWN BY	DATE	
	SCALE 3:2	SIZE A4			SHEET 3 OF 3	DWG NO MSAP-XXBMMM-SR8XXX	CHECKED BY Jinhai	DATE 2016-08-13
	REV. C	WC-REV. A.1			☉: Inspection item	CUSTOMER ALTW	APPROVED BY Jerry	DATE 2016-08-13

X-ON Electronics

Largest Supplier of Electrical and Electronic Components

Click to view similar products for [Sensor Cables / Actuator Cables](#) category:

Click to view products by [Amphenol](#) manufacturer:

Other Similar products are found below :

[60963](#) [60964](#) [703000D02F2002](#) [703001D02F0602](#) [703001D02F300](#) [704000D02F120](#) [773032K02F030](#) [802027107404-1](#) [802027213811-1](#)
[804001A09M150](#) [805001A09M0502](#) [84914-0235](#) [84914-0237](#) [885030A09M020](#) [8R4J30E03C3003](#) [1200651332](#) [1200651713](#) [1200660844](#)
[1200660845](#) [1200661173](#) [1200680071](#) [1200720053](#) [1200720081](#) [1200720099](#) [1200720217](#) [1200800231](#) [1200860125](#) [1200870123](#)
[1200980102](#) [1200650267](#) [1200650298](#) [1200660183](#) [1200660782](#) [1200660849](#) [1200661295](#) [1200661297](#) [1200661342](#) [1200661343](#)
[1200670080](#) [1200670220](#) [1200680331](#) [1200720252](#) [1200730184](#) [1200860344](#) [1200870359](#) [1200870643](#) [1200980008](#) [1200980031](#)
[1210502211](#) [1210400542](#)