

REV.	ECN NO.	DATE	SIGN	DESCRIPTION
A		2018/04/16	Brady	New Initial

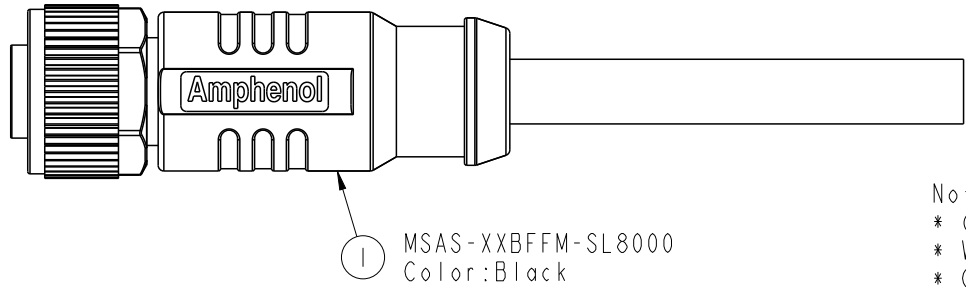
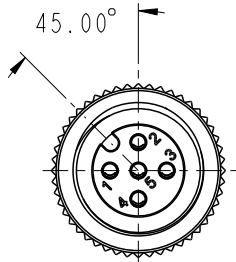
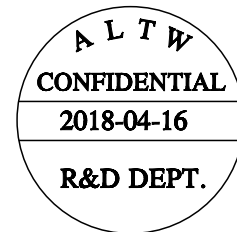
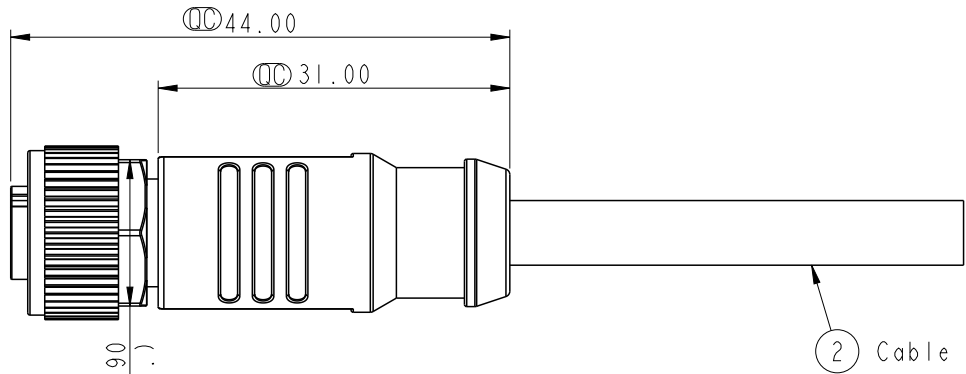

- Notes:
- * ④ Important Dimension.
 - * Waterproof Rate: IP68(Under water 1M for 24Hrs).
 - * Connector: Nylon+GF, Black.
 - * Female Pin: Copper Alloy, Gold Plated.
 - * Screw Nut: Zinc Alloy, Nickel Plated.
 - * Outer Mold: PP, Black.
 - * Cable: UL2517, Shield, PVC Jacket,UV resistant. Black.
UL20549,Shield, PU Jacket, Black.
 - * Rated Voltage: 3 & 4Pin 250V dc. or ac.
5Pin 60V dc. or ac.
6~12Pin 30V dc. or ac.
 - * Rated Current: 3~5Pin 4A
6~8Pin 2A
10~12Pin 1.5A
 - * Operating Temperature: -25~85°C

UNIT:mm
TOLERANCE
±0.5mm

TITLE M12 Shielded A Code Cable Female Conn.		
SCALE 3:2	SIZE A4	SHEET 1 OF 3
REV. A	WC-REV. A.3	④: Inspection item

Amphenol LTW
安費諾亮泰企業股份有限公司

ITEM NO	DRAWN BY Brady	DATE 2018/04/16
DWG NO MSAS-XXBFFM-SL8XXX	CHECKED BY Neo	DATE 2018/04/16
CUSTOMER ALTW	APPROVED BY Max	DATE 2018/04/16

THIS DOCUMENT IS SUBJECT TO CHANGE WITHOUT NOTICE. IT IS CONFIDENTIAL AND A PROPERTY OF Amphenol LTW. DISCLOSURE TO THIRD PARTY HAS TO BE AUTHORIZED BY Amphenol LTW.

F

E

D

C

B

A



12P	PU	6.4	26	MSAS-12BFFM-SL8EXX
8P		5.8	24	MSAS-08BFFM-SL8EXX
5P		5.7	22	MSAS-05BFFM-SL8EXX
12P	PVC	6.4	26	MSAS-12BFFM-SL8DXX
8P		5.8	24	MSAS-08BFFM-SL8DXX
5P		5.7	22	MSAS-05BFFM-SL8DXX
Contacts	Cable Jacket	Cable OD	AWG	Item No.

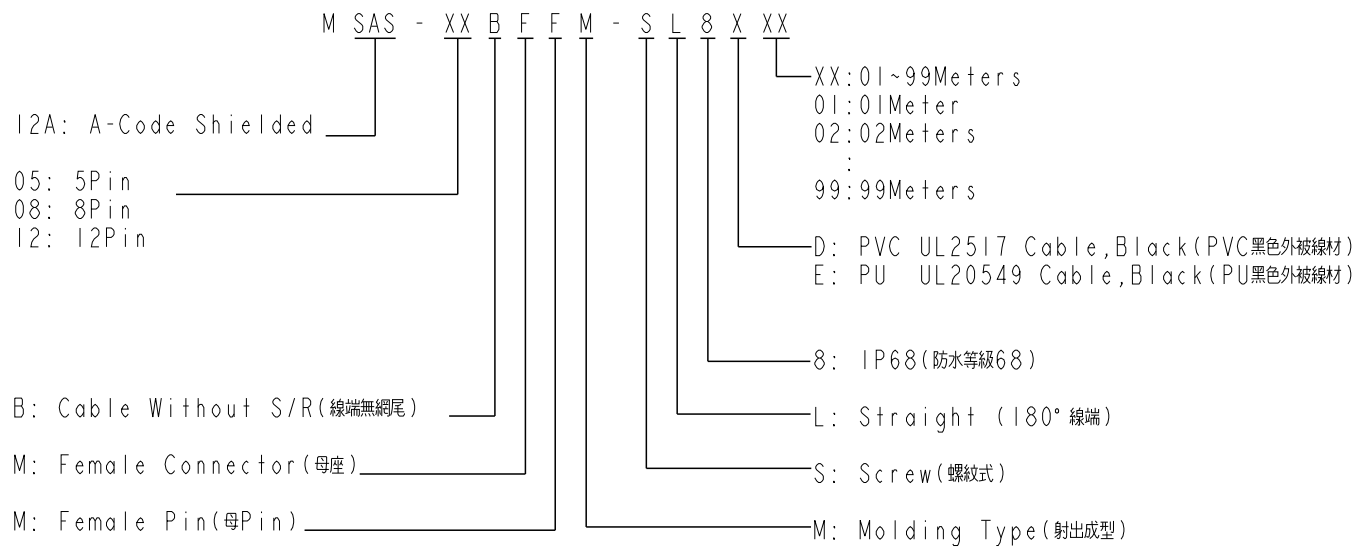

UNIT: mm	
TOLERANCE	±0.5mm

TITLE M12 Shielded A Code Cable Female Conn.			
SCALE 3:2	SIZE A4	SHEET 2 OF 3	
REV. A	WC-REV. A.3	QC: Inspection item	

Amphenol LTW
安費諾亮泰企業股份有限公司

ITEM NO	DRAWN BY Brady	DATE 2018/04/16
DWG NO MSAS-XXBFFM-SL8XXX	CHECKED BY Neo	DATE 2018/04/16
CUSTOMER ALTW	APPROVED BY Max	DATE 2018/04/16

THIS DOCUMENT IS SUBJECT TO CHANGE WITHOUT NOTICE. IT IS CONFIDENTIAL AND A PROPERTY OF Amphenol LTW. DISCLOSURE TO THIRD PARTY HAS TO BE AUTHORIZED BY Amphenol LTW.

THIS DOCUMENT IS SUBJECT TO CHANGE WITHOUT NOTICE. IT IS CONFIDENTIAL AND A PROPERTY OF AMPHENOL LTW. DISCLOSURE TO THIRD PARTY HAS TO BE AUTHORIZED BY AMPHENOL LTW.

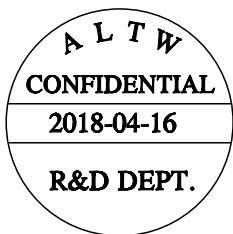

5	--		5	--		5	Gray	灰	8	--		8	Red	紅	12	--		12	Red/Blue	紅/藍
4	Black	黑	4	Black	黑	4	Black	黑	7	Blue	藍	7	Blue	藍	11	--		11	Gray/Pink	灰/粉
3	Blue	藍	3	Blue	藍	3	Blue	藍	6	Pink	粉	6	Pink	粉	10	Violet	紫	10	Violet	紫
2	--		2	White	白	2	White	白	5	--		5	Gray	灰	9	Black	黑	9	Black	黑
1	Brown	棕	1	Brown	棕	1	Brown	棕	4	Yellow	黃	4	Yellow	黃	8	Red	紅	8	Red	紅
									3	Green	綠	3	Green	綠	7	Blue	藍	7	Blue	藍
									2	Brown	棕	2	Brown	棕	6	Pink	粉	6	Pink	粉
									1	White	白	1	White	白	5	Gray	灰	5	Gray	灰
															4	Yellow	黃	4	Yellow	黃
															3	Green	綠	3	Green	綠
															2	Brown	棕	2	Brown	棕
															1	White	白	1	White	白

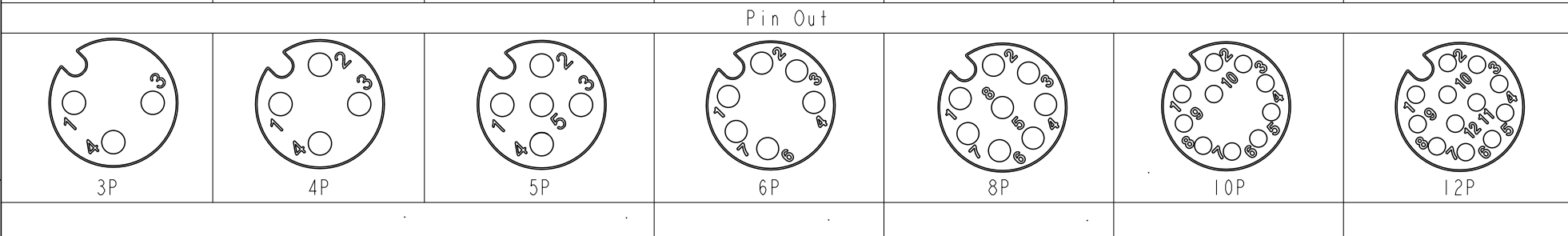

UNIT: mm TOLERANCE ±0.5mm		TITLE M12 Shielded A Code Cable Female Conn.		<h2 style="text-align: center;">Amphenol LTW</h2> <p style="text-align: center;">安費諾亮泰企業股份有限公司</p>	ITEM NO	DRAWN BY Brady	DATE 2018/04/16	
		SCALE 3:2	SIZE A4		SHEET 3 OF 3	DWG NO MSAS-XXBFFM-SL8XXX	CHECKED BY Neo	DATE 2018/04/16
		REV. A	WC-REV. A.2		Inspection item	CUSTOMER ALTW	APPROVED BY Max	DATE 2018/04/16

X-ON Electronics

Largest Supplier of Electrical and Electronic Components

Click to view similar products for [Sensor Cables / Actuator Cables](#) category:

Click to view products by [Amphenol](#) manufacturer:

Other Similar products are found below :

[60963](#) [60964](#) [M83513/19-F01CP](#) [703000D02F2002](#) [703001D02F0602](#) [703001D02F300](#) [704000D02F120](#) [773032K02F030](#) [802027107404-1](#)
[802027213811-1](#) [804001A09M150](#) [805001A09M0502](#) [84914-0235](#) [84914-0237](#) [885030A09M020](#) [8R4J30E03C3003](#) [1200651332](#)
[1200651713](#) [1200660844](#) [1200660845](#) [1200661173](#) [1200680071](#) [1200720053](#) [1200720081](#) [1200720099](#) [1200720217](#) [1200800231](#)
[1200860125](#) [1200870123](#) [1200980102](#) [1200650267](#) [1200650298](#) [1200660183](#) [1200660782](#) [1200660849](#) [1200661295](#) [1200661297](#)
[1200661342](#) [1200661343](#) [1200670080](#) [1200670220](#) [1200680331](#) [1200720252](#) [1200730184](#) [1200860344](#) [1200870359](#) [1200870643](#)
[1200980008](#) [1200980031](#) [1210502211](#)