

# Amphenol IT & Communications Products Group Main Sales Offices People's Republic of China

Amphenol China  
**Beijing Office**  
Room A 1110, Nanxincang International  
Tower, No.22 Dongsihitaio Street,  
Dongcheng District, Beijing  
Postalcode 100007  
P.R.China  
Tel:+86 10 64684019, 8523 5112  
Fax:+86 10 6468 4020  
E-mail: [info@amphenol.com.cn](mailto:info@amphenol.com.cn)

Amphenol China  
**Shanghai Office**  
Room1703, No.560 ZhangYang Road,  
Pudong New Area, Shanghai, China.  
Postcode: 200122.  
Tel: (8621) 58365500  
Fax: (8621) 58365618  
E-mail: [info@amphenol.com.cn](mailto:info@amphenol.com.cn)

Amphenol China  
**Shenzhen Office**  
Room 10 & 11,5/F, Metro Bldg .1016  
FuZhong YILU , FUJian , ShenZhen China  
Postalcode 518026  
P.R.China  
Tel: +86 755 23992529, 23992531,  
23992536, 23992532, 23992545,  
23992530.  
Fax: +86 755 23992540  
E-mail: [info@amphenol.com.cn](mailto:info@amphenol.com.cn)

**China Chengdu**  
Amphenol Commercial Products  
(Chengdu) Co., Ltd.  
Block D3, Chengdu Molding Tool Industry

Park, Hong Guang Town  
Telephone: 87988678 Fax: 87988704  
Code: 611731

**HongKong**  
Amphenol East Asia Ltd.  
2210 Railway Plaza 39 Chatham Road  
South Tsim Sha Tsui Kowloon Hongkong  
Tel:+852 2699 2663  
Fax:+852 2691 1774

**Singapore**  
Amphenol East Asia Ltd.  
Asia Pacific Sales Operations 300 Beach  
Road #25-07 The Concourse  
Singapore 199555  
Tel:+65 294 2128  
Fax:+65 294 3522 Amphenol Australia  
2 Fiveways Blvd., Keysborough  
Melbourne, Victoria 3173  
Australia  
Tel:+613 8796 8888  
Fax:+613 8796 8801

**Australia**  
Amphenol Australia  
2 Fiveways Blvd., Keysborough  
Melbourne, Victoria 3173  
Australia  
Tel:+613 8796 8888  
Fax:+613 8796 8801

**North America**  
Amphenol Asia US Sales Office  
42285-A Osgood Fremont, CA 94539  
USA

**America**  
Amphenol Corporation World Headquarters - Wallingford, CT, USA  
Tel: +1-203-265-8900 Fax: +1-203-268-8516  
Web: [www.amphenol.com](http://www.amphenol.com)

**Amphenol East Asia Electronic Technology(Shen Zhen)Co.,Ltd.**  
Block A3/A4, The 4th Ind.District of Industrial Headquarters  
Dong Keng Road, Gong Ming Town  
Shenzhen 518132  
P.R.China  
Tel:+86 755 27177945  
Fax:+86 755 27177622  
E-mail: [info@amphenol.com.cn](mailto:info@amphenol.com.cn) & [marketing@amphenol.com.cn](mailto:marketing@amphenol.com.cn)  
Web: [www.amphenol.com.cn](http://www.amphenol.com.cn)

Tel:+1 510 656 8330  
Fax:+1 510 656 8330  
**Europe**  
Amphenol European Sales  
Operations Hoofdveste 19 3992 DH  
Houten  
The Netherlands  
Tel:+31 30 6358000  
Fax:+31 30 6377034

**Japan**  
Amphenol Japan KK  
2-2-8 Shin-Yokohama Kohuku-  
ku, Yokohama-City Kanagawa 222-0033  
Japan  
Tel:+81 45 473 9191  
Fax:+81 45 473 9203

**Taiwan**  
Amphenol Taiwan Corporation  
No.116, Lane 956, Zhong Shan  
Road, Taoyuan City  
Taiwan  
Tel:+886 3 379 5677  
Fax:+886 3 360 7259

**Korea**  
Amphenol DaeShin  
#558 SoSa, Song Nae Bucheon-  
city, Kyunggi-Do  
Korea 422-040  
Tel:+82 32 610 3800  
Fax:+82 32 673 2507

# Amphenol

Connecting People + Technology  
IT & Communication & Commercial Connectors  
Product Overview

# Amphenol

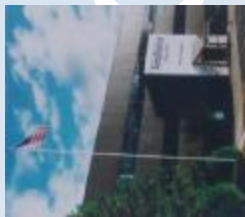

# Product Overview

## Amphenol

Amphenol is one of the world's largest interconnect manufacturers. Founded in 1932, Amphenol designs, manufactures, and markets electrical, electronic, and fiber optic connectors, interconnect systems, and coaxial and specialty cable. Amphenol was founded in 1932 as the American Phenolic Corporation by entrepreneur Arthur J. Schmitt. From Schmitt's initial innovation, the first mass-produced radio tube socket, Amphenol has focused on creative leading edge interconnect technologies that enhance the performance of our customers' products. We provide interconnect solutions for customers in the automotive, broadband, industrial, information technology and data communications, military and aerospace, mobile devices, and mobile networks markets. Whether producing billions of connectors for mobile phones or a single connector for the International Space Station, Amphenol has become the interconnect technology partner of choice to its customers.

Amphenol connecting people + Technology

# Contents

<b>1. Backplane Interconnect</b> (03–17)
2mm FB
AirMax
CDMA
Headers & Sockets
ACS
Backplane Power Connectors
Cardedge Connectors
Micro TCA Connector
SCA2
<b>2. Internal I/O (SATA/PATA)</b> (18–26)
Internal Micro SATA
Internal Micro SAS
SATA 6Gb/s
Slim I/O & Slimline SATA
PATA (Parallel ATA)
Internal Disk Drive Connectors
SATA Connectors & Cables
<b>3. Internal I/O (SCSI/SAS)</b> (27–34)
SAS
SCSI and Wide-SCSI
Device Interconnect
Spindle Motor Connectors
VHDCI
6Gb/s SAS
Mini PCI Express Connector
<b>4. External I/O (Traditional I/O Connectors)</b> (35–45)
Micro-Ribbon Connectors
MDR
Filtered Micro-Ribbon Connectors
USB & Harsh Environment USB
<b>External I/O (HDMI)</b> (46–48)
HDMI
DisplayPort
<b>External I/O (High-Speed I/O)</b> (49–60)
VHDCI
SFP, IPF and XFP
External SATA
External Mini-SAS
INFINITY (4X/12X)
<b>External I/O (Modular Jacks RJ 11 /45)</b> (61–77)
Standard Modular Jacks
Filtered and Shielded Connectors
SMT Series Connectors
Stacked Connectors
Harsh Environment Modular Jacks
<b>External I/O (D-Subminiature Connectors)</b> (78–100)
Telecom and Industrial
Commercial
Telecom and Industrial
<b>5. Portable Device Connectors</b> (101–106)
SIM Card Connectors
Battery and POGO Connectors
USB & Mini-USB
USB3.0
I/O Sockets and Docking Station Connectors
Memory Card & PCMCIA Sockets
Mini DisplayPort
Mini HDMI
Micro HDMI
BTB

# Amphenol



Amphenol East Asia Electronic Technology (Shenzhen) Limited is a member of Amphenol Group operating in China(ASCA). It was founded in 1984,located in Gongming town, Shenzhen City, P.R.C. It is a full license company with more than 2200 employees.

The main products of this company are low frequency telecom connectors, such as back plane (2mm,1DC DIN,Airmax) connectors, I/O connectors, connectors for storage devices and fiber optic. It has 7 sales branches in China, including Shenzhen, Shanghai, Beijing, Xian, Wuhan,Xiamen and Qingdao offices.

- Active in south China since 1984
- Low frequency connectors for storage system and telecom devices
- 2200+staff
- Wholly foreign owned enterprise



Amphenol Chengdu Factory

[RD&TOOLS](#)

[ASCA Information](#)

[QA & Assembly](#)

Amphenol Shenzhen Factory



Amphenol



# Backplane Interconnect Solutions

## Backplane Connectors



Amphenol is regarded as the world's most technically capable backplane manufacturer. Amphenol offers high performance circuits together with a full range of high-speed, high-density connectors, providing the widest range of backplane interconnect solutions tailored to customers' needs for different standards. This includes the Ventura, GbX, VHDM and the cost effective Airmax, with speeds ranging from less than 1 Gbps to 25 Gbps. Amphenol Commercial Products supplies the more traditional 2mm Future bus and DIN 41612 connector systems, and a series of innovative high-power Line card power connectors.



### 2mm Future Bus

The Amphenol's 2mm FB (Futurebus\*) connector is a modular 2.00mm grid system for high-density, board-to-board and cable-to-board applications. 2mm FB is available in 4- and 5-row versions and complies with the hard metric packaging standards used in high-density applications such as Futurebus+. The 2mm FB system offers design flexibility with PCB receptacles and headers that are end-to-end stackable in modular building blocks. The system includes a unique high-pressure press-fit pin design in both headers and receptacles. Available in header and receptacle assemblies with a choice of solder, press-fit or IDC lead.

Detailed Order information & Product Information pls refer to page 06



### AirMax VS

The AirMax VS connector utilizes edge-coupling technology to improve electrical impedance control with optimized stagger to minimize signal crosstalk. This innovative combination delivers a cost-effective interconnect for multi-gigabit/s applications. To leapfrog traditional complex Stripline designs, the AirMax VS solution utilizes "Virtual Shields," which eliminate costly metal interleaves between columns.

Detailed Order information & Product Information pls refer to page 07/08



### CDMA product introductions:

CDMA is a new I/O solution designed in cooperation with a major telecom equipment manufacturer for W-CDMA base stations and radio network controllers. Low Profile CDMA Front I/O Connector System Combines SMT Pick and Place Board Connectors with Shallow Positive Lock Cable Connectors. The goal was to combine signal (6x 622 Mbps or 4x 1.2 Mbps), hybrid (4 controls plus 2x 5 A) and power (2x 25 A) requirements in one connector system, which allows fully automated production of daughter cards (SMT Pick-and-Place) in a high-density shelf system with 15.0mm (0.59") Board-to-Board spacing. Board connectors come in tape and reel packaging for fully automated production. Cable connectors use fully EMI-proof diecast shells with a positive latching system which allows for easy installation, prevents the cable from being pulled out and prevents solder joints of the PCB connector to be stressed by locking the cable to the front panel. The cable assemblies are available in different cable lengths, types and configurations. They can be easily customized to suit customer needs and applications (e.g. D-SUB; RJ45; Mini-Fit; Mod-Plugs; etc.)

Detailed Order information & Product Information pls refer to page 09



### Headers & Sockets (812 / 816 / 821 / 916&912 Series)

Amphenol 812 series IDC Socket connectors can be used where quick connect and disconnect capabilities are required. Termination is fast and simple by means of IDC technology. Available in various sizes from 10 to 64 contacts with or without mold-in center polarizing key. Amphenol 816 series 4 wall-protected headers are available in right angle / straight mounting, with different tail lengths. Lock and eject latches may be added to reduce strain on the cable and PCB when removing mating socket connectors. The Amphenol 821 series of low profile protected headers is a cost effective solution to applications requiring quick connect and disconnect capability. The Amphenol 916 & 912 Series are the 1.27mm pitch while 812, 816&821 series are 2.54mm.

Detailed Order information & Product Information pls refer to page 10/14

Amphenol

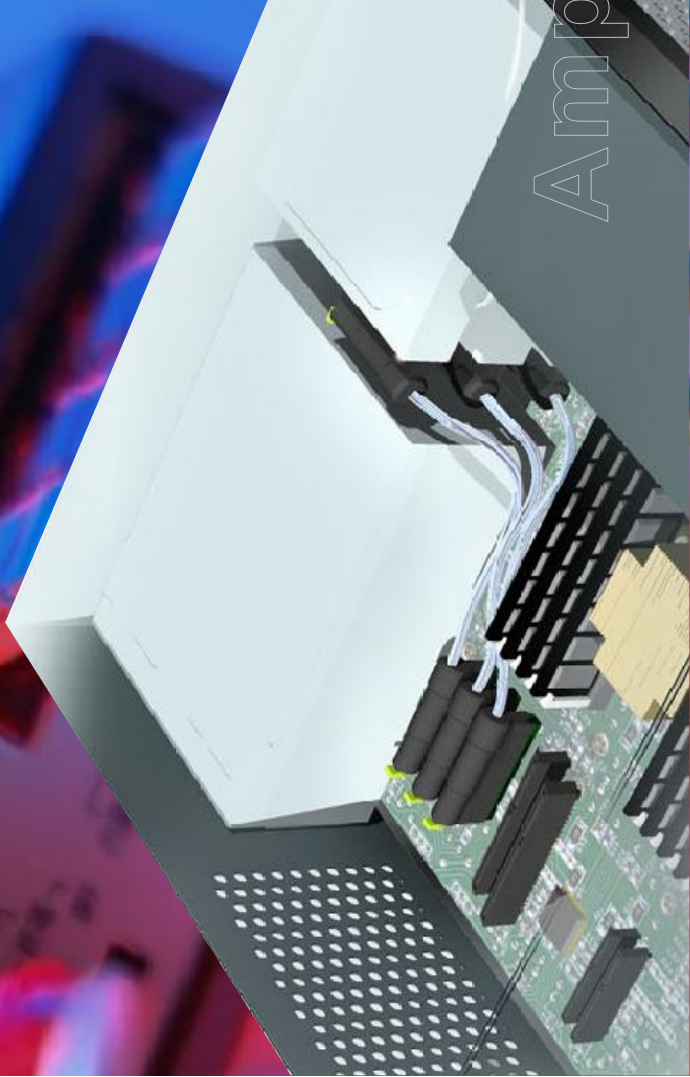





**ACS Series**  
Amphenol ACS series connector is designed for self-monitoring of blood glucose instrument. 8 pin terminals press the detective sensor to collect data. It has great performance on durability test and has small overall size to make the whole instrument with the smaller volume.

Detailed:Order information & Product Information pls refer to page 15



**Backplane Power Connectors**  
Amphenol's Backplane Power series is designed to package high power availability in a small form factor, with customized options. This new range has many unique features to meet or exceed existing competitive products in power density.  
The connectors are available in various forms to transfer power from source to line cards, and from the backplane to line cards or mezzanine cards. Other designs allow for direct power from the bus bar into the line cards without adding complexity to mid-plane. These connectors are available with 40 amp and 60 amp contacts.  
The 60 amp contacts incorporate the Radsok technology allowing a 50% increase in current.



**Features**  
High reliability  
Low voltage drop  
High cycle durability  
Low insertion force  
Low cost  
High power density



**Cardedge Connectors**  
The Amphenol Cardedge connectors include PCI, AGP, DIMM, DDR2 connectors. The latest member is PCIe-Express which complies with the PCI SIG specification for desktop PCIe-Express implementation. It supports a 2.5 Gbps data transfer rate (per pair of data bandwidths). Its scalable modular design maximizes card interoperability for user flexibility. PCIe-Express enables hot plug connection and hot swap. Available in 1X (36pos), 4X (64pos), 8X (96pos) and 16X (164pos).



**Micro TCA Connector(Advanced Mezzanine Card Conn)**  
Micro TCA(Micro Telecom Computing Architecture) Connector is for micro TCA application, and complementary to ATCA (Advanced Telecommunications Computing Architecture)  
The connector has two rows contacts spaced on 0,75mm centreline. There are 170 contacts (2\*85) on the mating face. It is mated to 1,6mm thickness printed circuit board.



**SCA2**  
Amphenol SCA2 (Single Connector Attachment) allows SCSI disk drives to be attached directly to backplanes.  
Available in 40- or 80-position  
Blindmate direct attachment of disk drives to backplanes or motherboards  
Single I/O connector for 3.5" SCSI disk drives  
Accepted polarized "D" connector interface  
Meets the requirements of Specifications SFF-6045 and SFF-6046

## Ordering Information

### 2MM Series

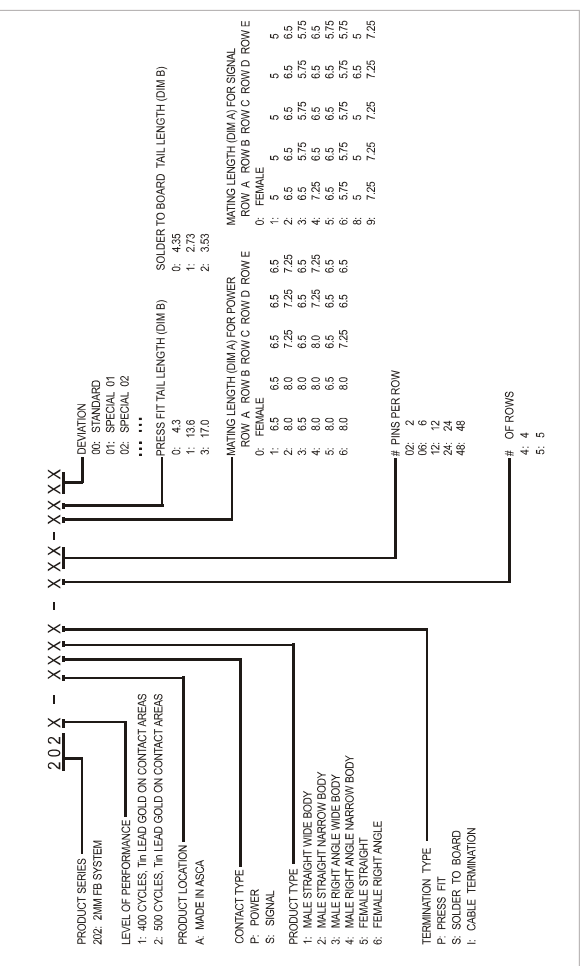

## Product Information

### Amphenol 2mm FB Connector



# Amphenol

## Ordering Information

### AirMax VS Series

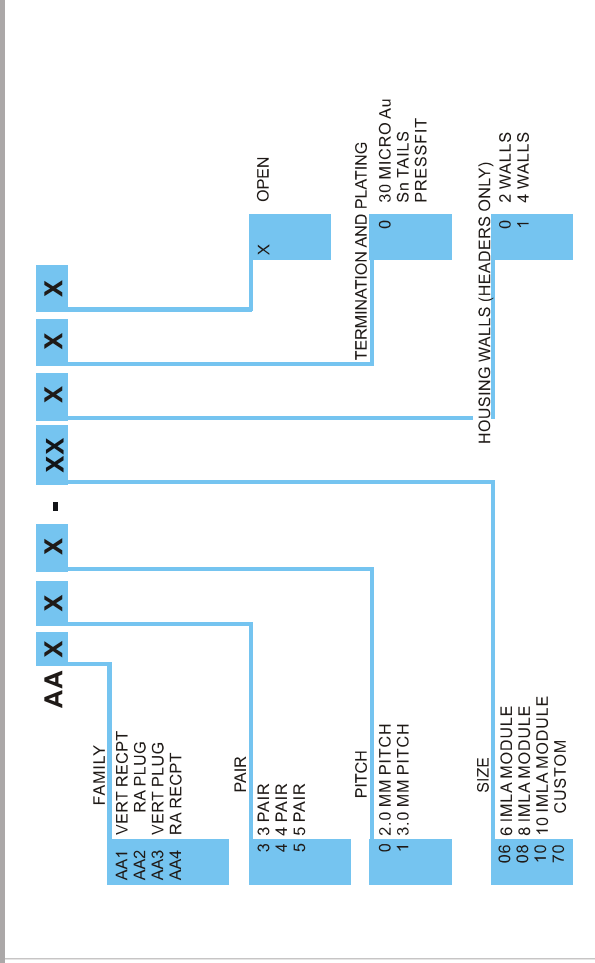

## Ordering Information

### AirMax VS Series

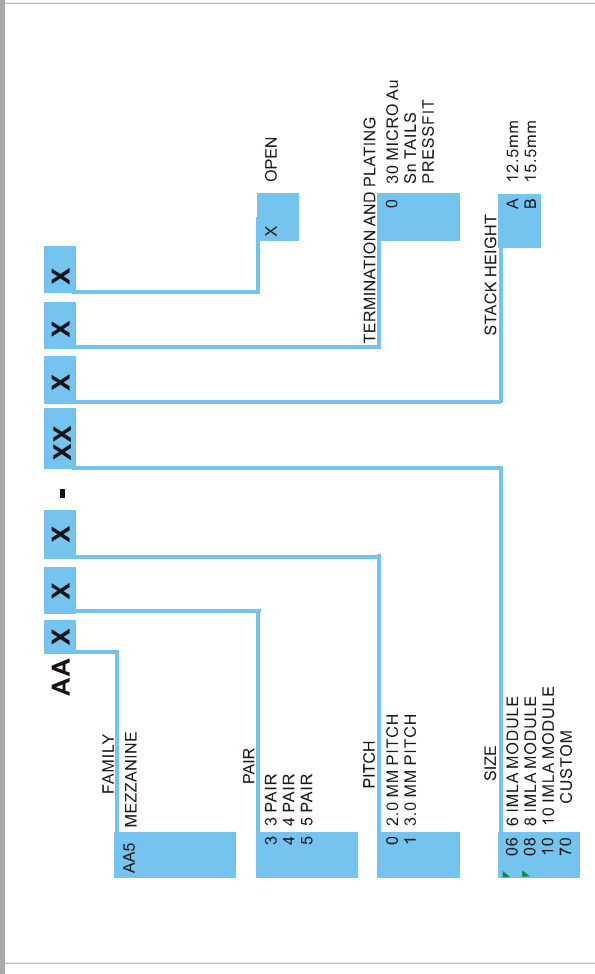

## Product Information

### Amphenol AirMax Connector

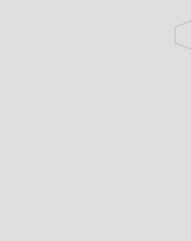
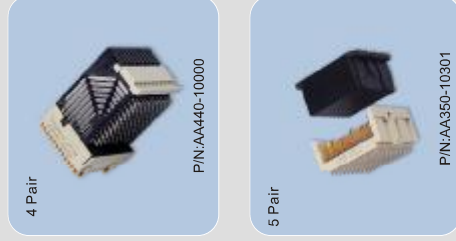

## Product Information

### Amphenol AirMax Connector

Amphenol



## Ordering Information

### CDMA Series

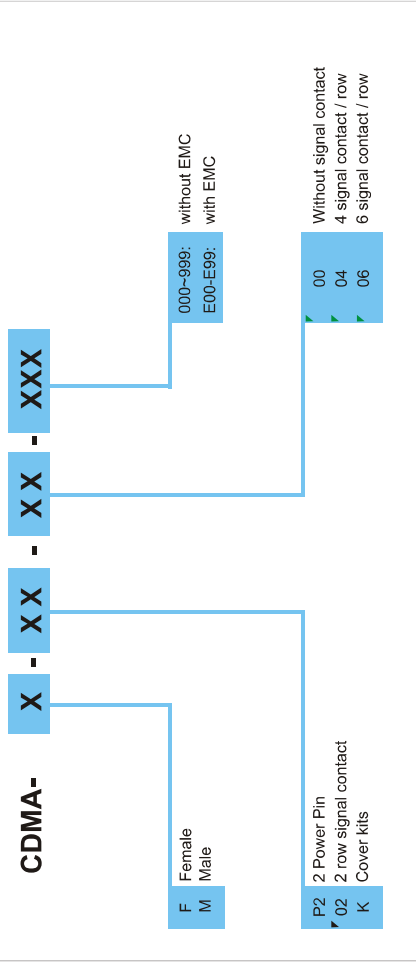

## Product Information

### Amphenol CDMA Series Connector



## Ordering Information

### 812 Series

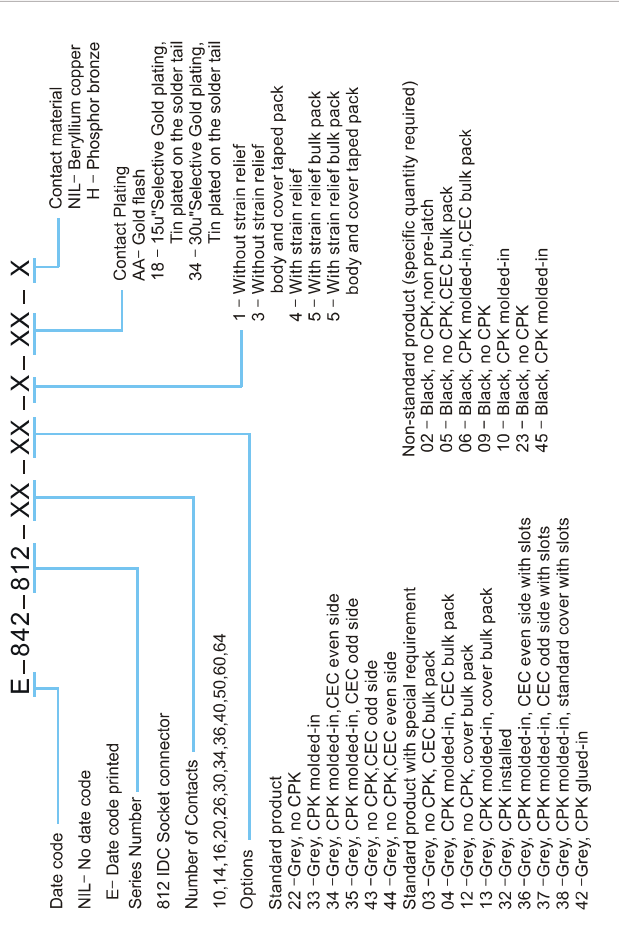

## Product Information

### Amphenol 812 Series

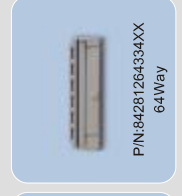
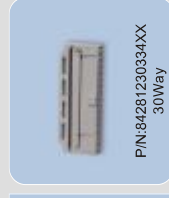

## Ordering Information

### 816 Series

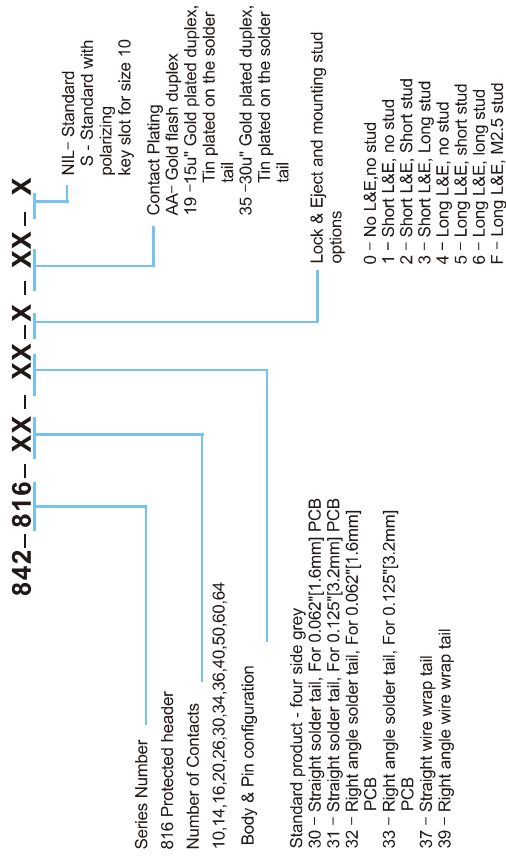

## Ordering Information

### 821 Series

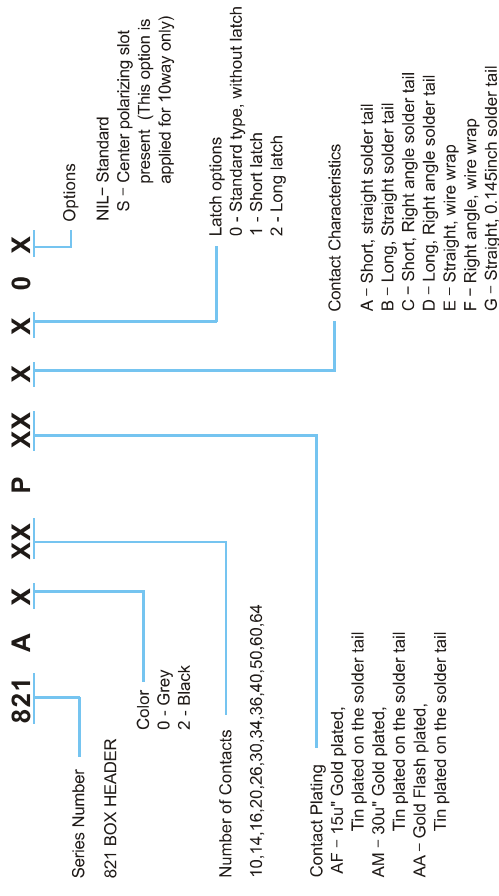

## Product Information

### Amphenol 816 Connector

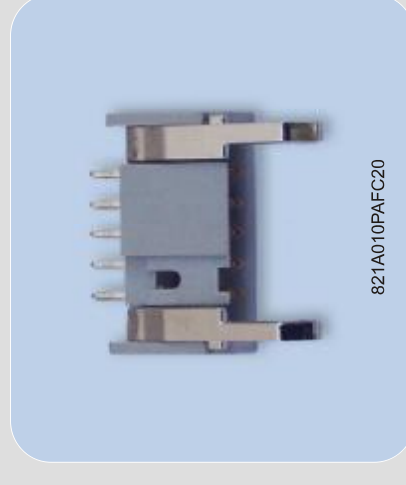
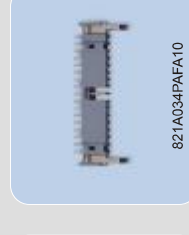
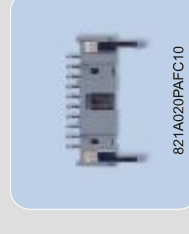



## Ordering Information

### 912 Series

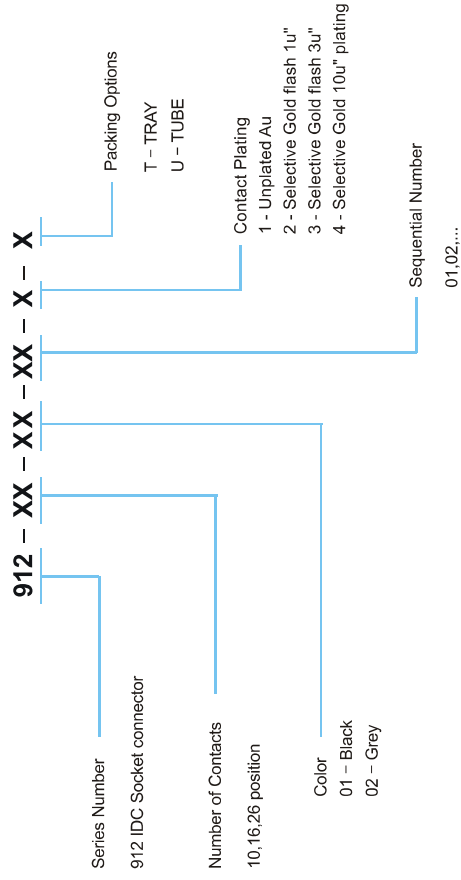

## Ordering Information

### 916 Series

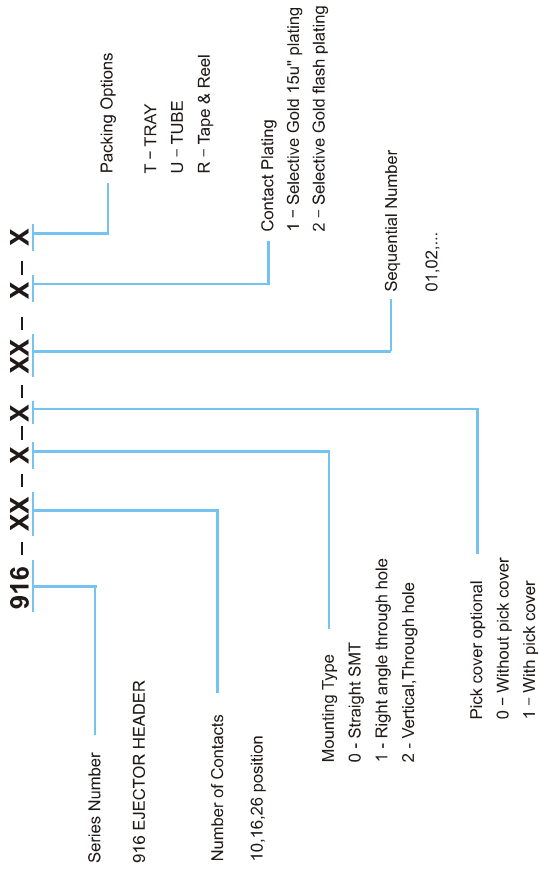

## Product Information

### Amphenol 912 Connector



## Product Information

### Amphenol 916 Connector



Amphenol

## Ordering Information

### SCA2 Series

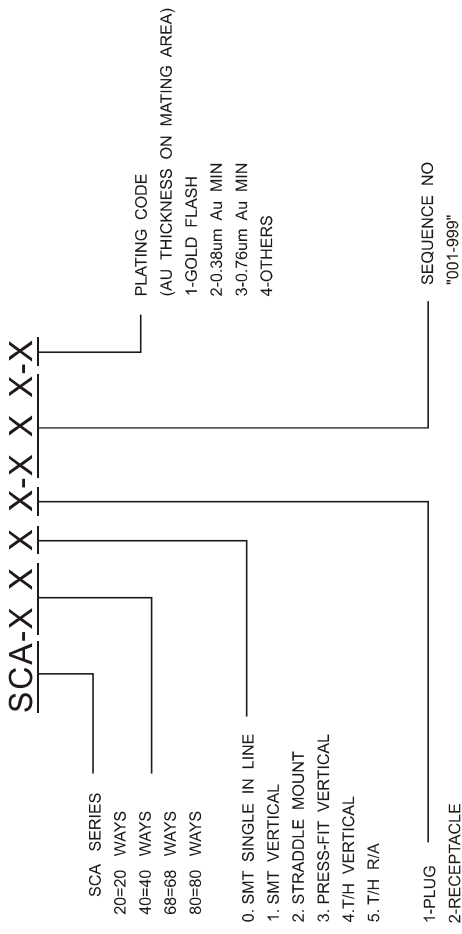

## Ordering Information

### Micro TCA Series

#### Micro TCA-170-B-X-X-X

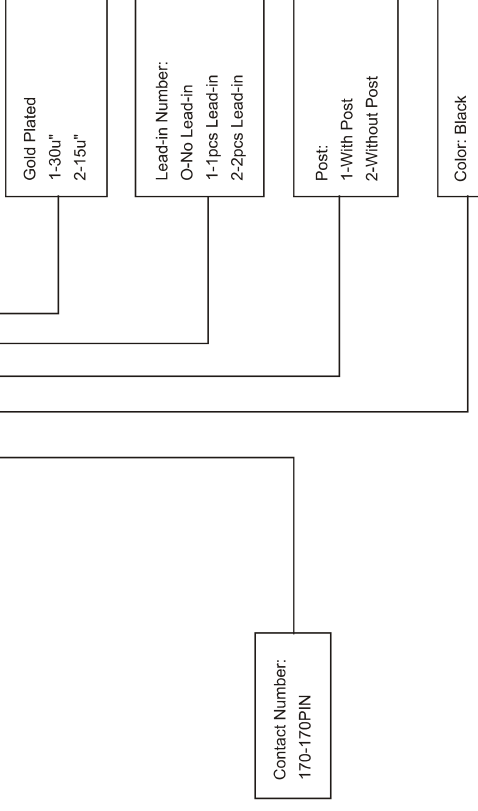

## Product Information

### Amphenol SCA2 Connector



## Product Information

### Amphenol Micro TCA Connector





## Ordering Information

### ACS Series

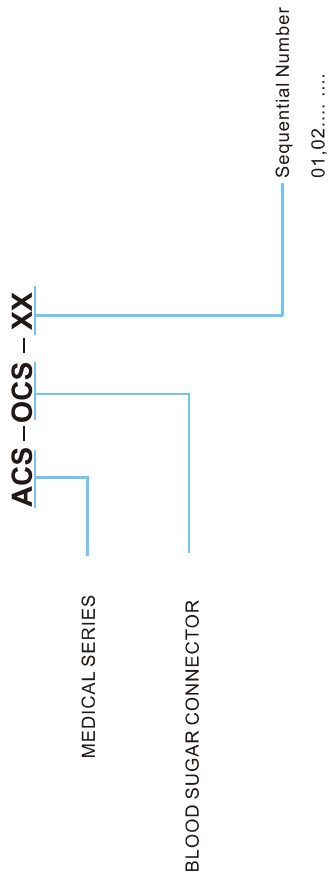

## Product Information

### Amphenol ACS Connector



# Internal I/O

## SATA/PATA & Internal Disk Drive Connectors



Amphenol is at the leading edge of technology in the fast growing Server and Storage market, offering integrated inside-the-box interconnect solutions including SATA, SAS, PATA, SCSI, SCA2, Mini-SAS, CF I and CFII. We offer various mounting methods including Straddle Mount, Straight or Right Angle Solder DIP, and SMT. The solutions cover board mount connectors, device I/O and cable assemblies for all form factors of hard disk drives including 0.8", 1", 1.8", 2.5" and 3.5". In addition, we supply a complete family of internal connectors for hard disk drives.

Amphenol



#### SATA (Serial ATA)

Serial ATA provides much higher speed of data transfer than the traditional Parallel ATA standard. Its cable is much smaller than that of SATA and provides better air flow within the device box, lowering manufacturing and maintenance costs. It also allows for flexibility in system design. Amphenol offers a complete range of plug and receptacle connectors (signal and power). Standard and customized cable assemblies are offered in conjunction with connectors.

#### Plug/Receptacle Options

- Combo Plug (Signal+Power)
- Straddle Mount, SMT or Solder-DIP
  - Combo Plug with Testing Pin
  - Combo Plug with Legacy Combo Solder DIP

- Combo Receptacle (Signal+Power)
- Combo Receptacle Straight, SMT
  - Combo Receptacle Straight Solder-DIP

- Plug (Signal)
- Straight or Right Angle Solder-DIP or SMT
  - Double Deck Right Angle SMT
  - 4x1 Straight or Right Angle SMT

- Cable end (Signal+Power)
- Solder or crimping

Detailed: [Order information & Product Information](#) pls refer to [page 19](#)

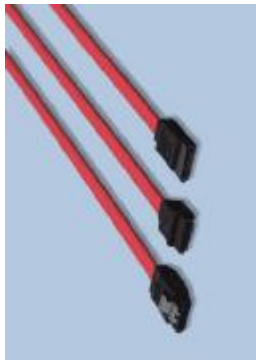

#### Internal Micro SATA

Amphenol's internal micro SATA connector is designed to enable connection of a slim 1.8 inch form factor HDD or SSD to the Serial ATA interface. The internal micro Serial ATA connector uses the 1.27mm pitch configuration for both the signal and power segments. The signal segment has the same configuration as the internal standard Serial ATA connector. The power segment provides the present voltage requirement support of 3.3 V, and includes a provision for a future voltage requirement of 5 V. In addition, there is a reserved pin, P7. Finally, there are two optional pins, P8 and P9, for vendor specific use.

Detailed: [Order information & Product Information](#) pls refer to [page 21](#)



#### Internal Micro SAS

Amphenol's internal Micro SAS connector uses the same 1.27mm pitch for both the signal and power segments as the Micro SATA connector as defined in the SATA specification. In addition, it contains a second signal segment on 0.8mm pitch similar to the SAS internal connector as defined in SFF8482. It contains an optional pair of contact opposite the primary signal contact group.

Detailed: [Order information & Product Information](#) pls refer to [page 20](#)



#### SATA 6Gb/s

Amphenol's SATA 6Gb/s doubles the maximum transfer speed from 3 gigabit/second to 6 gigabit/second, allowing consumers to move large amounts of data at a faster rate. It is backward compatible with 3Gb/s and 1.5Gb/s, allowing the same cables and same connectors configuration as 3Gb/s

Detailed: [Order information & Product Information](#) pls refer to [page 20](#)



#### Slim I/O & Slimline SATA

The Amphenol slim I/O board-to-board connector is designed to fit into low profile, 0.8mm contact space for standard SATA interface. The connector is used in applications such as the thin DVD or CD-ROM drive bay for notebook computers. Amphenol slimline SATA is designed to achieve size compatibility with SATA connector slimline designs. Without changes to the drive case media tray or internal mechanics, it simply requires a replacement of the SATA PCB with a SATA controller and the slimline connector.

#### PATA (Parallel ATA)

A PATA connector is included in the Amphenol traditional 864 series, which combines signal, power and control in one connector. This feature yields lower manufacturing cost and high productivity in the PCB assembly. The connector meets SFF-8059 Specification. PATA cable assemblies are available for customized requirements.

- Polarizing features available for proper mating
- Higher temperature plastic available for SMT assembly
- Four friction dimples in the power portion hold the mating receptacle more firmly
- Straddle mount for PCB thickness: 1.22~4.0, 1.3mm
- Through hole for PCB thickness: 1.27~4.0, 1.3mm



#### Internal Disk Drive Connectors

Amphenol supplies Board-to-Board and Spindle Motor connectors specifically designed for hard disk drive application for all form factors including 0.8", 1", 1.8", 2.5" and 3.5". Our Read/Write connectors range from compressive header/socket to board to board connectors. In addition, Amphenol supplies a full range of spindle motor connectors and jumpers. Amphenol is also a leading supplier of interconnect solutions to other storage devices such as optical drives.



#### SATA Connectors & Cables

Amphenol offers a complete range of standard and customized Serial ATA (SATA) cable assemblies. SATA provides much higher-speed data transfer than the traditional Parallel ATA STANDARD. SATA cables are also much smaller than that of PATA and provide better airflow within the device box, lowering manufacturing and maintenance costs.

Amphenol



# Ordering Information

## SATA Series

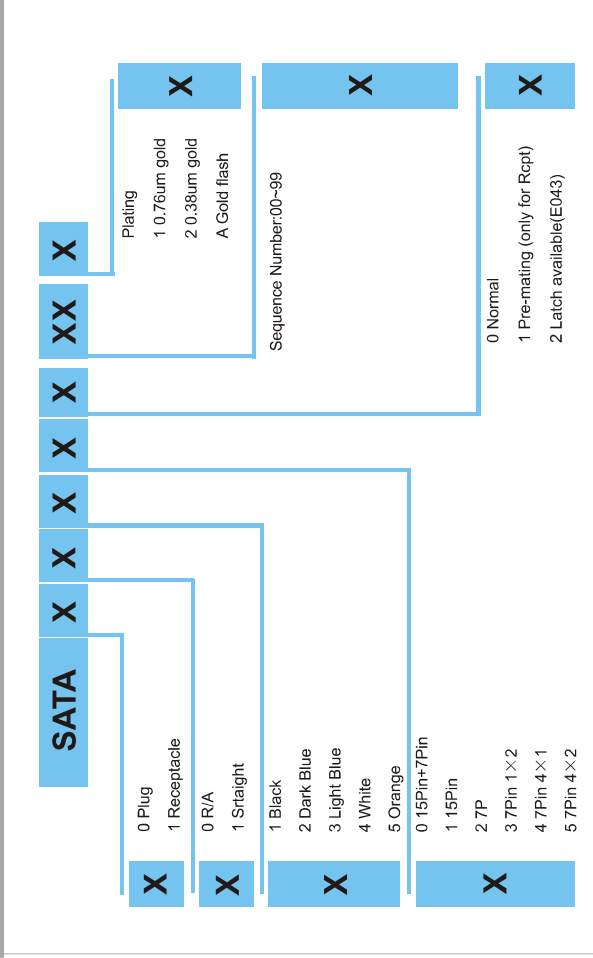

# Product Information

## Amphenol SATA Connector

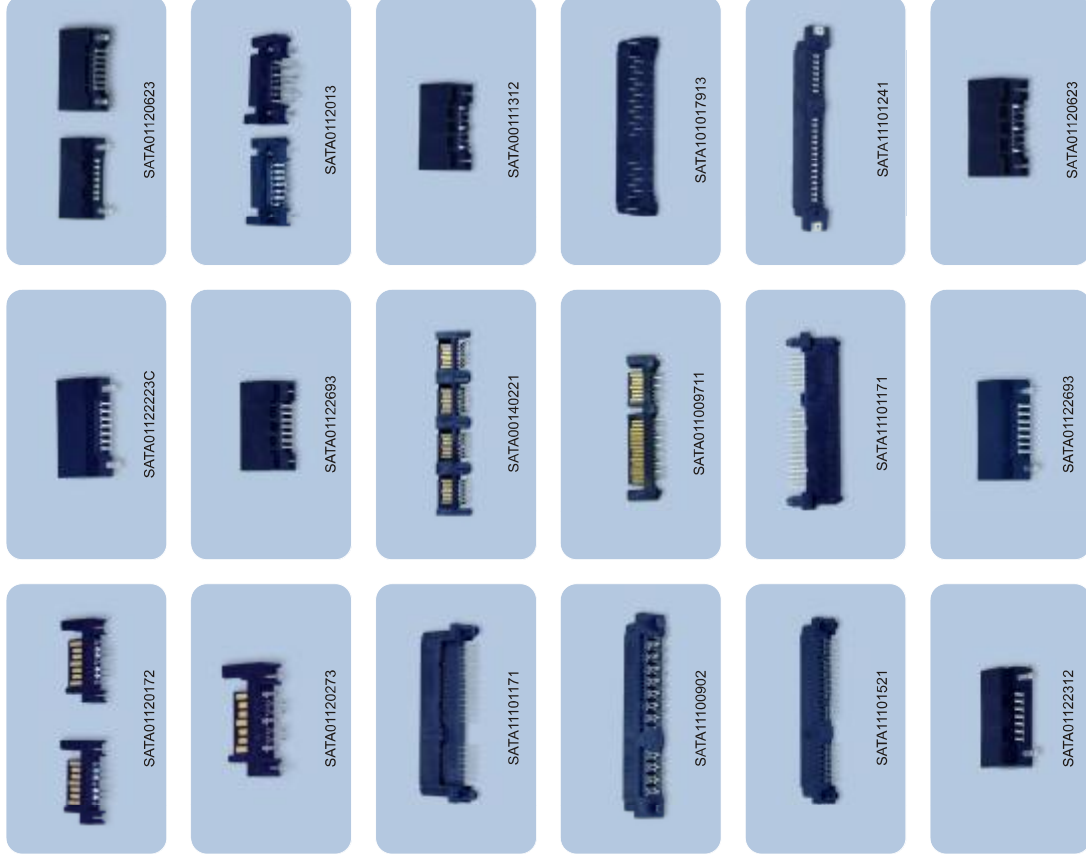

Amphenol



## Ordering Information

### SSATA Series

	SSATA	X	X	X	X	XX	X	X	X
0 Plug 1 Receptacle	X								
0 R/A 1 Straight	X								
1 Black 2 Nature	X								
0 6Pin+7Pin 1 6Pin	X								
Plating 1 0.76um gold 2 0.38um gold 3 Gold flash 4 0.20um gold									X
Packing 1 Tray 2 Carry Tape									X
Sequence Number									X
0 Normal 1 Pre-mating (only for Rcpt) 2 Latch available(E043)									X

## Ordering Information

### LSATA Series

	LSATA	X	X	X	X	XX	X	X
0 Plug 1 Receptacle	X							
0 R/A 1 Straight	X							
1 Black 2 Dark Blue 3 Light Blue 4 White 5 Orange	X							
0 24PIN	X							
Plating 1 0.76um gold 2 0.38um gold 3 Gold flash 4 0.20um gold								X
Packing 1 Tray 2 Carry Tape								X
Sequence Number								X
0 Normal								X

## Product Information

### Amphenol SSATA Connector



## Product Information

### Amphenol LSATA Connector

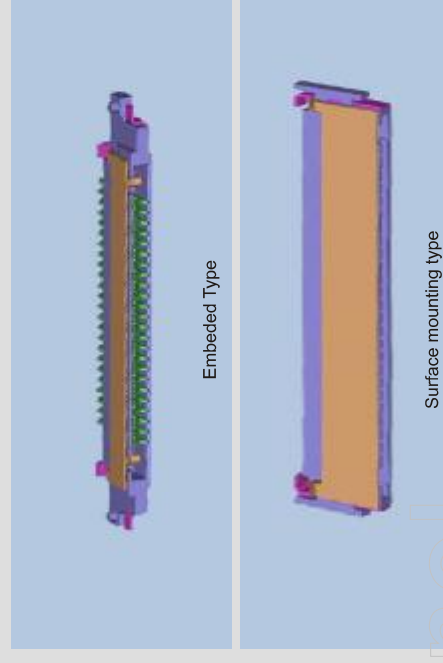

# Internal I/O SCSI/SAS

Amphenol has been a leading supplier of SCSI connectors, cable and cable assemblies. We have also established a full range of the next generation SAS (Serial attached SCSI). Together with other internal interconnect products, Amphenol enables customers unprecedented flexibility in choosing the right class of connection in environments requiring performance, scalability and reliability



## SAS (Serial attached SCSI)

SAS (Serial attached SCSI) is a point to point connectivity storage system architecture that has many advantages over its parallel SCSI predecessor. It is designed to replace the SCSI interconnect system with a much smaller, more flexible serial design. SAS connectors allow devices to be cabled or directly attached to the backplane. Data speed can be up to 6 Gbps. Amphenol provides a full range of SAS cable and board mount connectors as well as cable assemblies.

### Connector Position

19-pos, 29 pos, 32pos

### Backplane

- Straight Receptacle Solder DIP
- Straight Receptacle SMT
- Straight Receptacle Hybrid (Soldier DIP + SMT)
- Straight Receptacle Press-Fit
- Straight Plug SMT
- Straight Plug Press-Fit
- Right Angle Receptacle Solder
- DIP Right Angle Receptacle SMT
- Right Angle Plug SMT

### Cable-end

- Cable Plug
- Cable Receptacle

- Faster data speed (up to 6.0Gbps) and much better system performance
- Point-to-point topology eliminating the need of hubs allows for flexible system topology and better scalability of system
- Allows more disk arrays in the same space as needed in the SCSI system
- The cable length can be longer than 8 meters without causing any defect in signal transmission
- Simpler cable routing and better system airflow
- Compatible also with SATA disk drives
- Meets the requirement of SFF-8482 Specification

Detailed Order Information & Product Information pls refer to page 26

## SCSI and Wide-SCSI

Amphenol provides a wide range of SCSI-1, -2, -3 connectors for cable mounts, PCB mounts and cable assembly. SCSI (Small Computer System Interface) is a parallel I/O bus system used to connect computers to peripheral devices such as disk drives, tape drives and printers. The Amphenol wide-SCSI 3-in-1 combo combines the signal, ID and power together in one connector with the following selections:

- SCSI + Header (6x2) + Power, Straddle Mount
- SCSI + Header (6x2) + Power, Surface Mount, Single in Line
- SCSI + Header (16x2) + Power, Straddle Mount

Amphenol





## Ordering Information

### SAS Female Series

SAS-F	X	X	X	X	X	XX	X	XX	XX	XX
0 R/A Through Hole										
1 Straight Through Hole	X									
2 R/A SMT										
3 Straight SMT										
4 R/A Hybrid										
5 Straight Hybrid										
6 R/A Pressfit										
7 Straight Pressfit										
8 Cable Termination										
1 Black	X									
0 W/O Any Accessory										
1 Hold Down										
2 Board Lock										
3 Solder TAB										
4 Plastic Post or Board Lock										
NIL Standard C Cover TR Tape and Reel										X
Plating 1 0.76 um gold 2 0.38 um gold A Gold flash										X
Sequence Number										X
TBA										X

## Ordering Information

### Micro SAS Female Series

MSAS-F	X	X	X	X	X	X	X	XX	X	XX
2 R/A SMT	X									
3 Straight SMT										
8 Cable Termination										
1 Black	X									
0 W/O Any Accessory										
1 Hold Down										
2 Board Lock										
3 Solder TAB										
4 Plastic Post or Board Lock										
NIL Standard C Cover TR Tape and Reel										X
Plating 1 0.76 um gold 2 0.38 um gold A Gold flash										X
Sequence Number										X
TBA	X									

## Ordering Information

### Micro SAS Female Series

MSAS-F	X	X	X	X	X	X	X	XX	X	XX
2 R/A SMT	X									
3 Straight SMT										
8 Cable Termination										
1 Black	X									
0 W/O Any Accessory										
1 Hold Down										
2 Board Lock										
3 Solder TAB										
4 Plastic Post or Board Lock										
NIL Standard C Cover TR Tape and Reel										X
Plating 1 0.76 um gold 2 0.38 um gold A Gold flash										X
Sequence Number										X
TBA	X									

## Product Information

### Amphenol SAS Female Connector

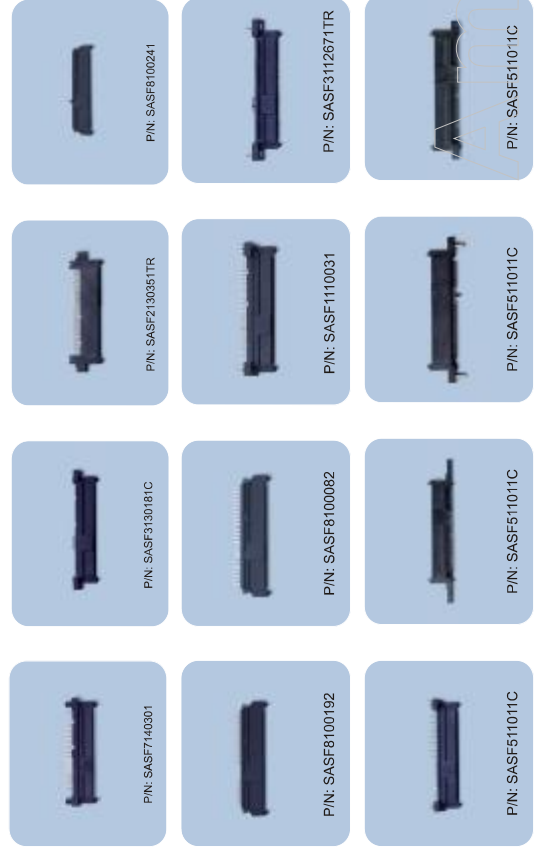

## Product Information

### Amphenol Micro SAS Female Connector

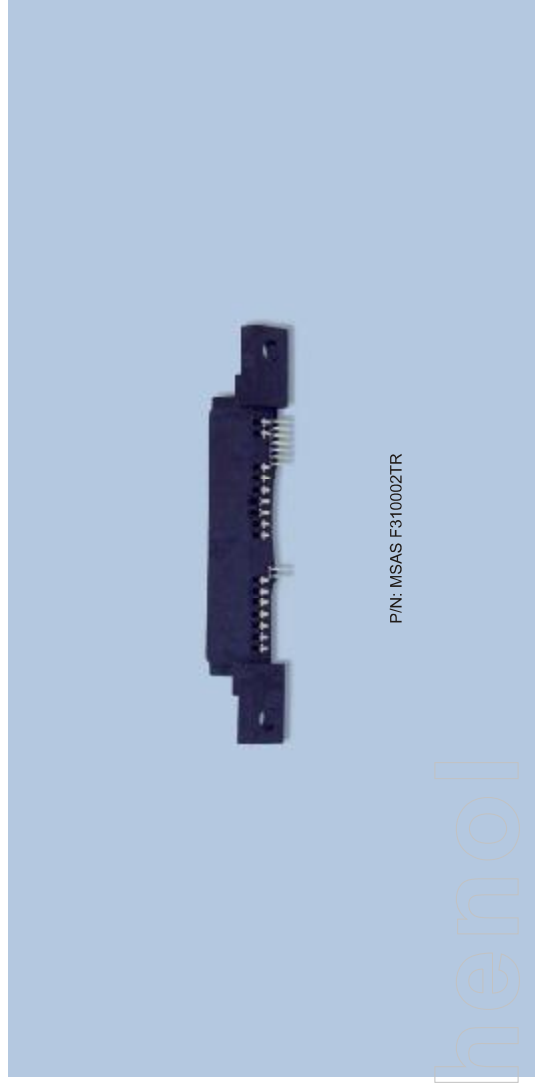

## Ordering Information

### Micro SAS Male Series

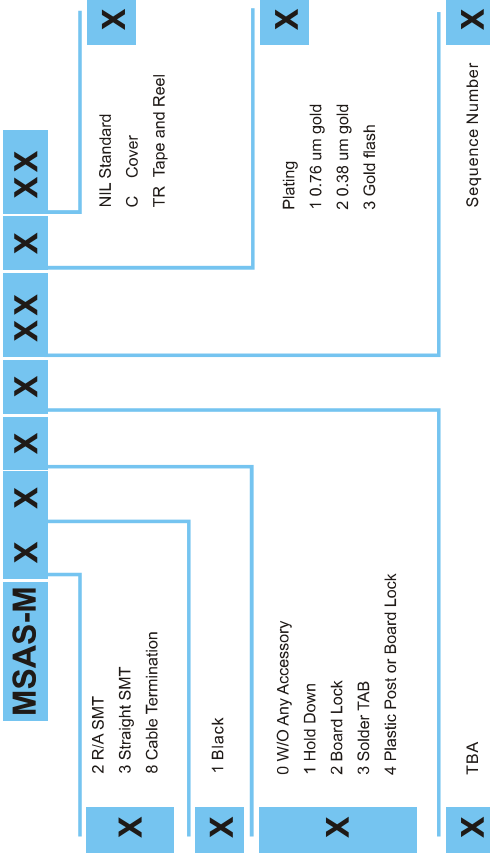

## Ordering Information

### RPS Series

### RPS Part Number System

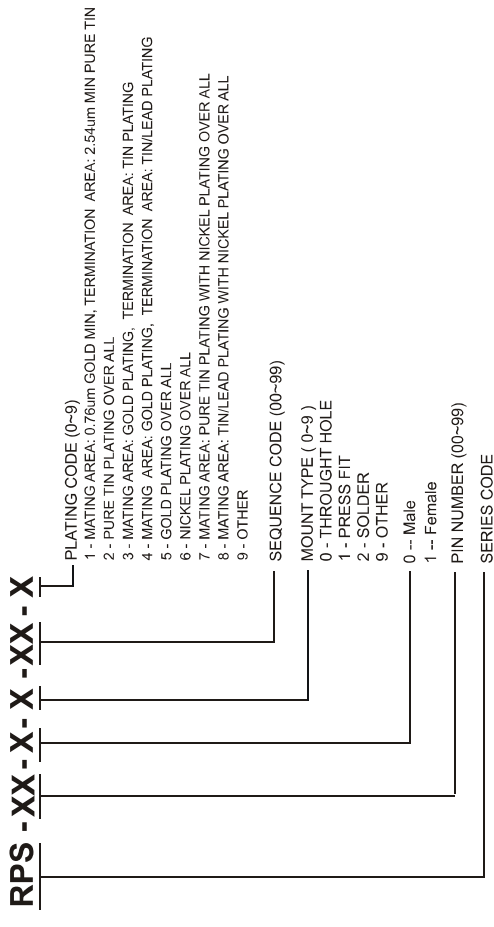

## Product Information

### Amphenol Micro SAS Male Connector



P/N: MSAS M3100012TR

## Product Information

### Amphenol RPS Connector



RPS 0111978



RPS 0111008



RPS 0101978

# External I/O

## Traditional I/O Connectors

Amphenol provides a wide range of input/output connectors for different market segments and applications. In addition to complete product families of high-speed interconnect, modular jacks, D-Subs and professional audio connectors, Amphenol manufactures all industrial standard products as well as customized connectors that are tailored to our customers' unique environments.



### Micro-Ribbon Connectors

The 57 series Micro-Ribbon (Centronics) connectors offers a fast, economical and distinctively different method of achieving electrical interconnection with contacts designed to mate easily and positively. The connectors are available in rack and panel, cable to panel, cable to cable and PCB types; The 57LE series Micro-Ribbon connectors offers a low cost Right Angle PCB mount version.

The 157 series Micro-Ribbon IDC cable mount connectors combines the field-proven features and reliability of 57 series Micro-Ribbon solder type connectors with the speed and convenience of IDC solderless terminations.

The 257 series (SCSI-2) provides a cost effective solution to data transfer applications. Available with 50, 68 and 100-way contact connectors, cable mount and board mount. The 957 connectors are tailor made double deck, high-density Micro-Ribbon connectors.

Detailed Order information & Product Information pls refer to page 30/34



### MDR

Amphenol's MDR is a high-density shielded I/O connector with a broad range of board-mount, wire-mount, and cabling components. Ribbon contact is on a grid, which provides a small footprint connector, creating a reliable system for repetitive plugging and unplugging in I/O application.

The 858 MDR (Mini D Ribbon) connectors are high-density shielded I/O connectors. Available with 28, 68 and 100-way contact connectors, cable mount and board mount.

Detailed Order information & Product Information pls refer to page 38



### Filtered Micro-Ribbon Connectors

Amphenol FCC57 series of Filtered "Micro-Ribbon" connectors provides a very cost effective solution to EMI. This family of connectors is the telephone industry's standard connectors for multiple lines interconnect. Available in 36, 50 and 64 sizes, Amphenol also offers a variety of termination styles: male/female adapters, right angle PCB, vertical, press-fit and solder cup. A variety of capacitance values are available including capacitors that can meet high voltage requirements. These connectors were designed to fit in the same footprint as the 57/157 standard micro-ribbon connectors.



### USB & Harsh Environment USB

The Amphenol series of USB receptacles and plugs is a complete system of interconnection technology designed in accordance with Universal Serial Bus Specifications Version 2.0 and using asynchronous and isochronous data transfer rates of up to 480 Mbps. Available with different mounting options, including through hole, SMT stack and vertical mount. Connector type includes Type A, Type B and Type AB. Amphenol's harsh environment MUSB is designed to meet IP67, military shock and vibration standards. Utilizing die cast metal shells, MUSB is usable with various mounting and termination methods. The PosiLock USB series provides a locking latch to prevent accidental un-mating. The series accepts standard USB plugs.



Amphenol



## Ordering Information

### 57 Series

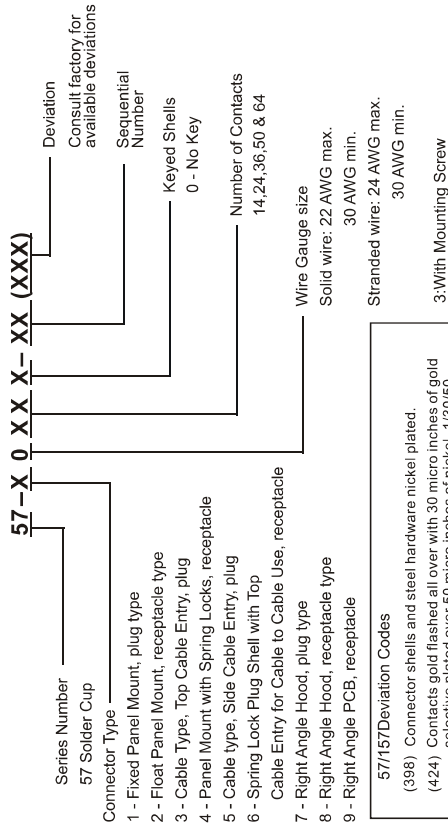

**57/157 Deviation Codes**

(398) Connector shells and steel hardware nickel plated.  
(424) Contacts gold flashed all over with 30 micro inches of gold selective plated over 50 micro inches of nickel. 1/30/50  
(441) Tin over nickel plated shells.  
(448) 57/157 series contacts plated 30 micro inches gold select over 50 nickel all over contacts have bare edges.  
(450) 57/157 series contacts plated 50 micro inches gold select over 50 micro inches nickel all over contacts have bare edges.

## Ordering Information

### 57LE Series

Deviation Codes  
0 - #4-40 UNC-2B Standard ground tab  
D3 - 3.2 mm through hole ground tab  
D29 - Beardlock (soldering tab)  
D47 - Low Cost 57LE CONNECTOR, 4-40 RIVETS WITH BOARDLOCKS  
D55 - Same as D47 But Beardlock FOR 0.125" PCB Hole  
D98 - 64 PIN WITH B/L 4-40 RIVET FOR MOUNTING  
D99 - NO FLASH FOR Panel of FRONT SHELL

### 57LE Part Number System

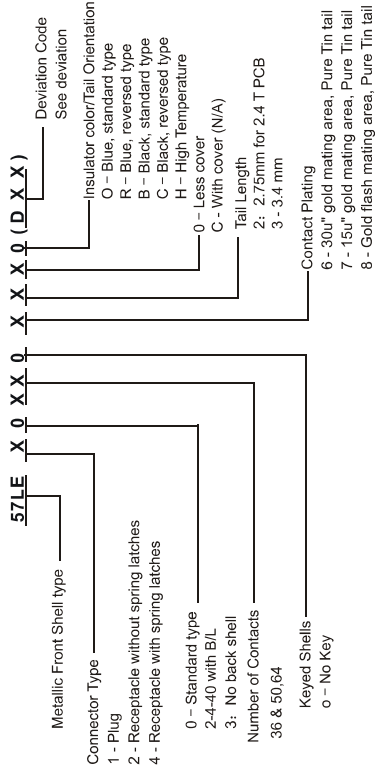

## Product Information

### Amphenol 57 Connector



50Way, R/A, Female, Spring latch



64way R/A Male 577064017



Low profile, 50 way, R/A, Female

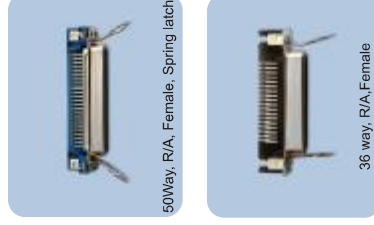

50Way, R/A, Female, Spring latch

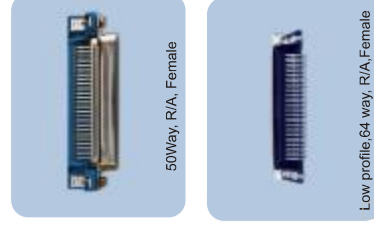

Low profile, 64 way, R/A, Female

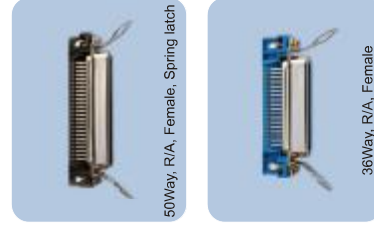

50Way, R/A, Female, Spring latch

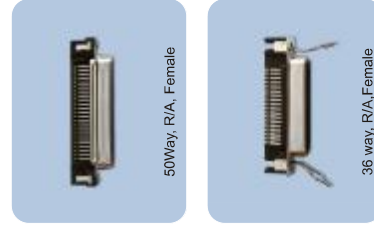

36 way, R/A, Female

## Product Information

### Amphenol 57LE Connector

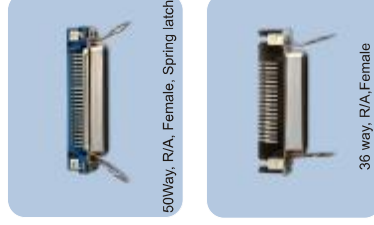

50Way, R/A, Female

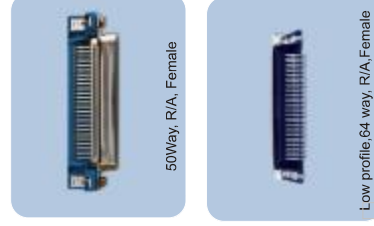

36Way, R/A, Female

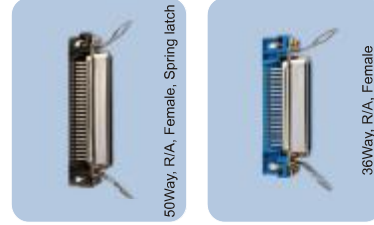

50Way, R/A, Female, Spring latch

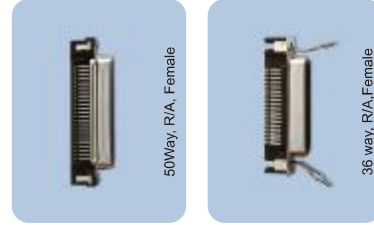

36 way, R/A, Female

# Amphenol

## Ordering Information

### 157 Series

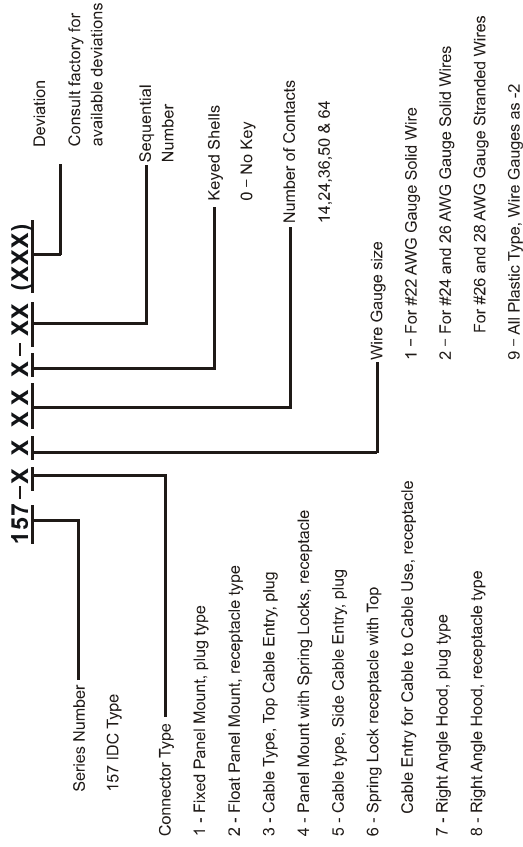

## Ordering Information

### 257 Plug Series

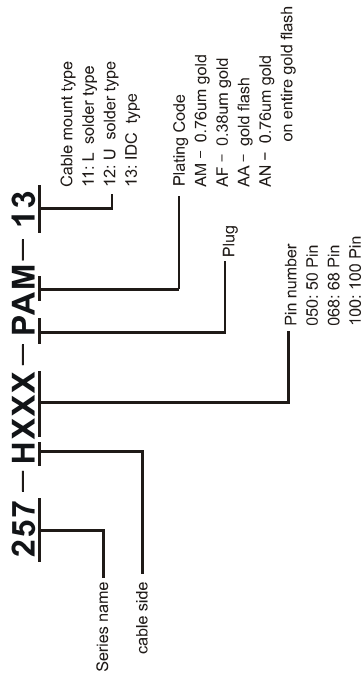

## Product Information

### Amphenol 157 Connector

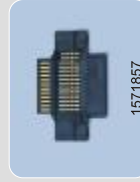

1571857



15772500448



157755001



157125003



15712640



157250010441



157125002539872



1573250018



257H068PAM11



257H068PAM12



257H068PAM13



257H100PAM13

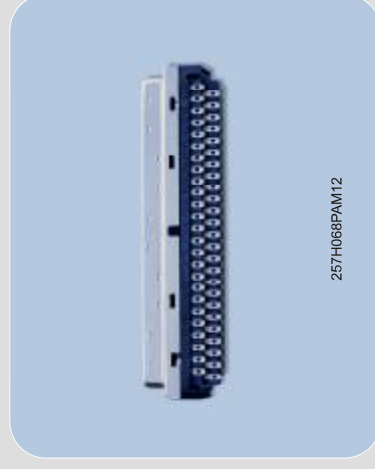

257H068PAM12

Amphenol

## Ordering Information

### 257 Receptade Series

#### 257-XXXXS XX XX

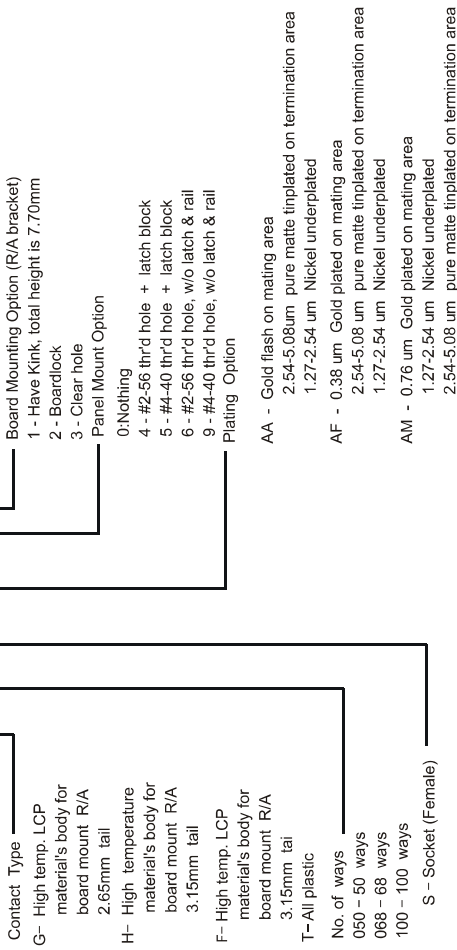

## Ordering Information

### 858 Part Number System for female

#### 858F-XXX-XX-X-XXX-X

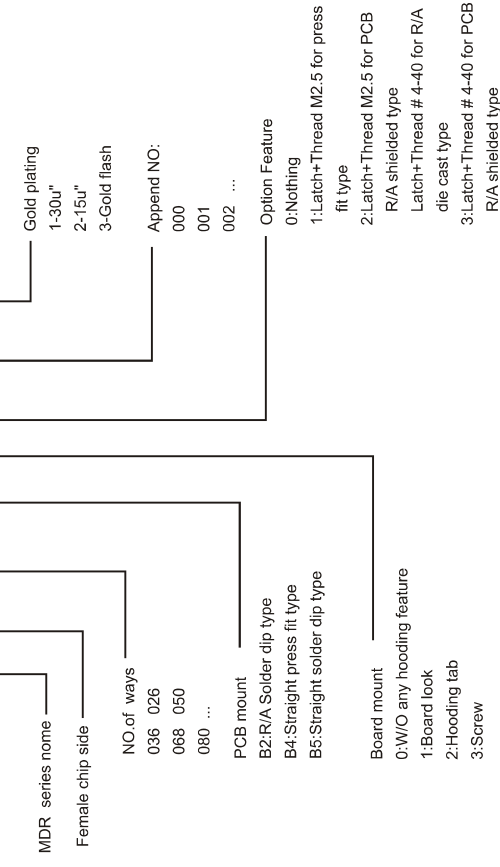

## Product Information

### Amphenol 257 Receptade Connector

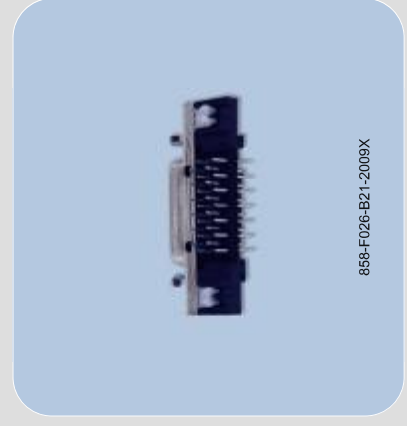
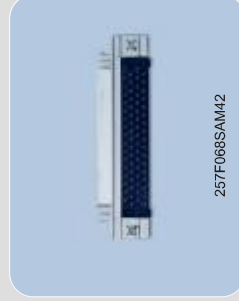

## Ordering Information

### 858 Part Number System for Male (cable type)

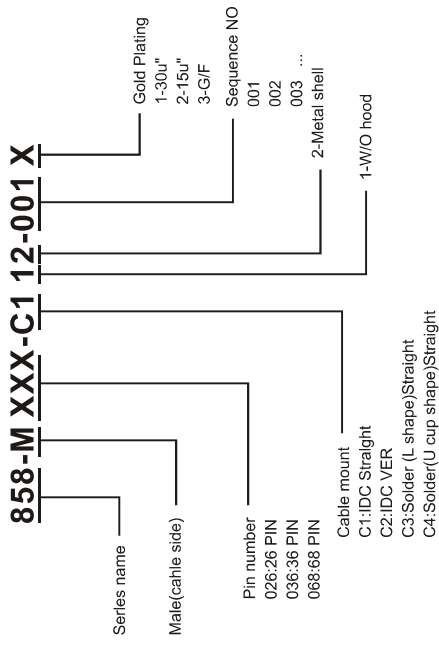

## Ordering Information

### 957 Female Series

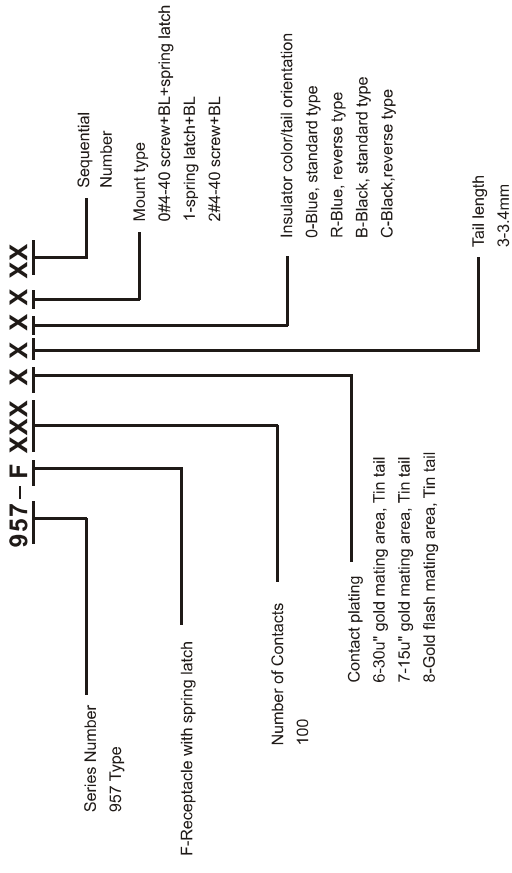

## Product Information

### Amphenol 858 Connector



858M026-C112-0011



858-M036-C112-0011



858M068C3120011



858M068C4120011

## Product Information

### Amphenol 957 Female Connector

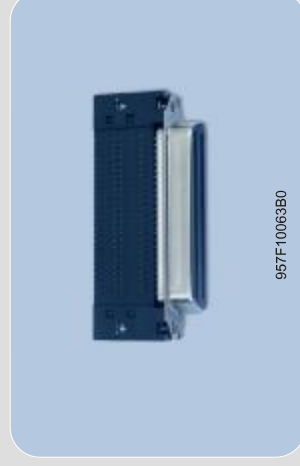

957F10063B0



957F10063B05

Amphenol



## Ordering Information

### 957 Male Series

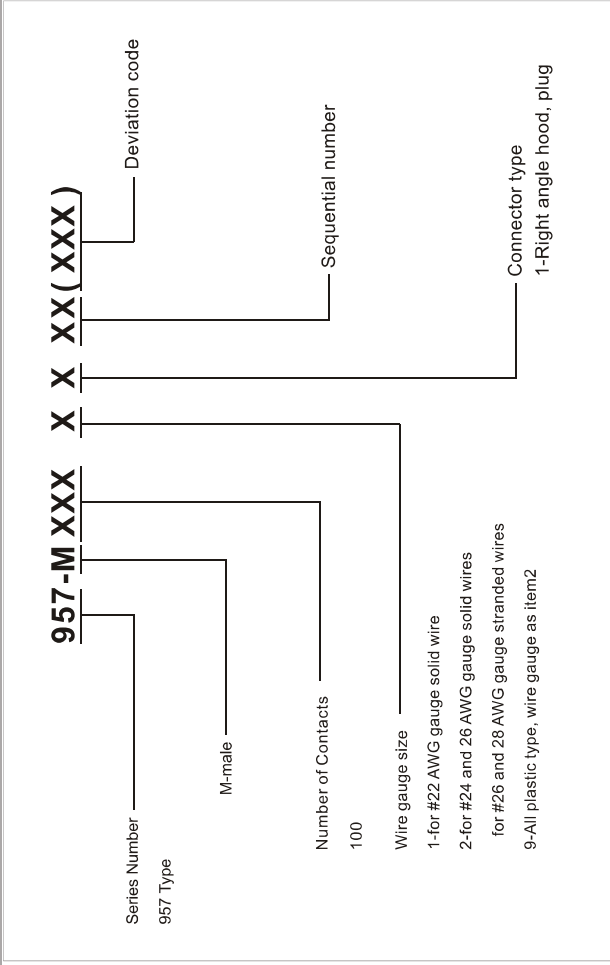

## Product Information

### Amphenol 957 Male Connector



# External I/O HDMI

High-Definition Multimedia Interface (HDMI) is a compact audio/video interface for transmitting uncompressed digital data. HDMI connects digital audio/video sources such as set-top boxes, Blu-ray Disc players, personal computers (PCs), video game consoles, and AV receivers to compatible digital audio devices, computer monitors, and digital televisions.

HDMI is a small, user-friendly interconnect that can carry up to 5 Gbps of combined video and audio in a single cable. The 0.50mm (.020") pitch SMT connectors are fully shielded for ESD protection, gold plated for reliability and are 100% compliant RoHS.

The DisplayPort is designed for internal and external system solution for high bandwidth audio and video data transfer in the notebook and PC market. The standards, defined by Video Electronics Standards Association (VESA), cover provisions for high definition digital audio-video and graphics streaming via the interface through the same cable. This reduces cost and provides ease of use through the plug-and-play feature making it user-friendly for consumer. It also provides performance scalability for future developments of high quality displays, high color depths and high refresh rates display.



Amphenol

## Product Information

### Amphenol Display Port Connector

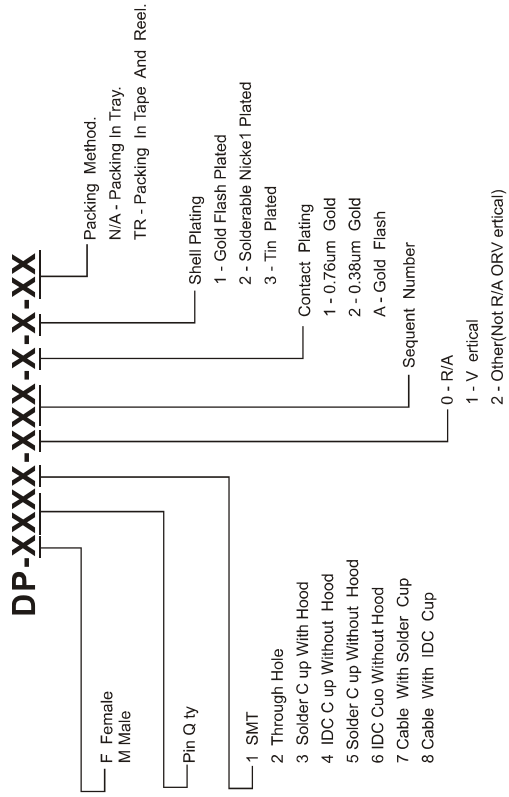

## Ordering Information

### HDM-F Series

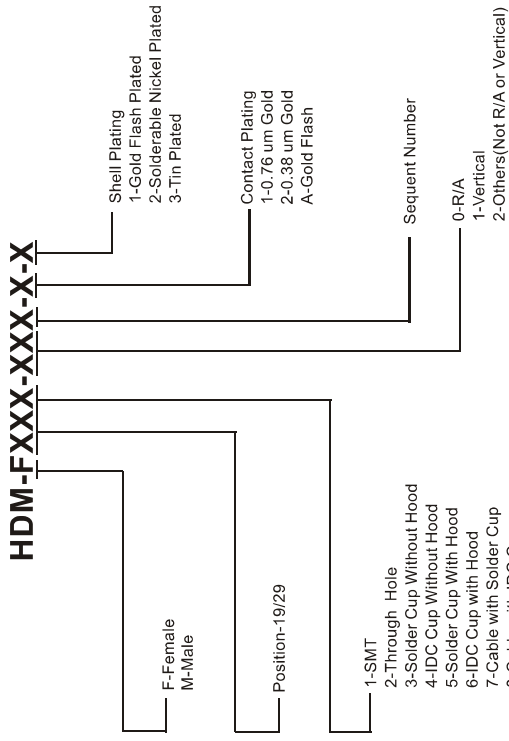

## Product Information

### Amphenol Display Port Connector



## Product Information

### Amphenol HDM-F Connector



Amphenol

# External I/O High-Speed I/O



Amphenol offers a full range of high-speed connectors with data rates ranging from 1 Gbps to 80 Gbps and beyond, meeting customers' various high-speed connector requirements and objectives including:

- Increased platform density for scaling improved performance in defined physical space
- Servers that can scale I/O and processing power independently
- Racks of servers that can be managed as one autonomous unit
- Servers that can share I/O resources
- True "plug-and-play" I/O connectivity

Connector	Data Speed
RJ45 Giga	1 Gbps
VHDCI	4 Gbps and higher
SFP	4 Gbps and higher
External SATA	3 Gbps
External Mini-SAS	3 Gbps and higher
Infinity 4x	10 Gbps and higher
XFP	10 Gbps
Infinity 12x	30 Gbps



## VHDCI (Very High Density Cable Interface)

VHDCI (Very High Density Cable Interface or Ultra-SCSI) provides interconnections where space limitations and high performance are key requirements. Designed to be compact, these fully shielded connectors support ESD/EMI protection, are capable of transferring data up to 4 Gbps and meet EIA709AAAF specifications. Receptacles are available in both right angle and straddle-mount configurations with or without shield EMI tabs. Plugs are available with a variety of back shells, or without a back shell for over-molding purposes. VHDCI cable assemblies are available for customized requirements.

Detailed: [Order information & Product Information](#) pls refer to [Page 51](#)

## SFP, IPF and XFP Connector and Cage Assembly

Amphenol's extensive range of high-speed SFP/IPF connector and cage solutions utilize a 20 position connector with a metal cage enclosing the connector. SFP (Small Form Factor Pluggable) is used to support Fiber Channel, Fast Ethernet and Gigabit Technology. We offer all sizes including single port, ganged (1 xN) and the stacked (2xN) family, with data speeds up to 4 Gbps per port and higher. More special features such as LEDs will continue to be introduced. The cages are a one-piece construction with enhanced transceiver mating tabs. The cages are available in a press-fit or solder version and longer or shorter pins are available. The next generation XFP connector and cage will allow the speed to reach 10 Gbps per port.

## External SATA

Amphenol's high performance external SATA has evolved from SATA that was originally designed as internal or inside-the-box interface technology. External SATA brings the same performance and features to external storage needs. A data speed of 3 Gbps is much faster than contemporary external storage solutions such as USB 2.0 and Firewire (IEEE 1394). Available in both board mount and cable end connectors, e-SATA cable assemblies satisfy customized requirements.

## External Mini-SAS

Amphenol's External Mini-SAS is one of the latest members of the high-speed I/O family. This connection system is based on industry-proven card edge style contacts. Mini-SAS is designed to satisfy the needs for gigabit serial data transmissions with signal speeds across the connector interface of up to 3 Gbps and higher. The cage is mounted separately to the body so that the stress imposed by insertion and removal of the cable plug does not affect the signal / body solder joints.

## INFINITY (4X/12X)

Amphenol's INFINITY 4X & 12X series of connectors facilitates data speeds up to 10 & 30 Gbps respectively, as required by InfiniBand, Fiber Channel and Serial Attached SCSI Trade Associations, with superior EMI performance. INFINITY connectors are high-density and hot pluggable, and meet Specifications SFF-8470. A variety of receptacles, plugs and cable assemblies are available to fit multiple connectors into a 1U form factor and PCI bracket. Plug kits are available with a variety of cable size options as well as a unique low profile version that will allow a belly-to-belly configuration in a 1U form factor chassis. INFINITY cable assemblies are available for customized requirements.

Amphenol











## X-ON Electronics

Largest Supplier of Electrical and Electronic Components

*Click to view similar products for [Sensor Cables / Actuator Cables](#) category:*

*Click to view products by [Amphenol](#) manufacturer:*

Other Similar products are found below :

[60963](#) [60964](#) [M83513/19-F01CP](#) [703000D02F2002](#) [703001D02F0602](#) [703001D02F300](#) [704000D02F120](#) [773032K02F030](#) [802027107404-1](#)  
[802027213811-1](#) [804001A09M150](#) [805001A09M0502](#) [84914-0235](#) [84914-0237](#) [885030A09M020](#) [8R4J30E03C3003](#) [1200651332](#)  
[1200651713](#) [1200660844](#) [1200660845](#) [1200661173](#) [1200680071](#) [1200720053](#) [1200720081](#) [1200720099](#) [1200720217](#) [1200800231](#)  
[1200860125](#) [1200870123](#) [1200980102](#) [1200650267](#) [1200650298](#) [1200660183](#) [1200660782](#) [1200660849](#) [1200661295](#) [1200661297](#)  
[1200661342](#) [1200661343](#) [1200670080](#) [1200670220](#) [1200680331](#) [1200720252](#) [1200730184](#) [1200860344](#) [1200870359](#) [1200870643](#)  
[1200980008](#) [1200980031](#) [1210502211](#)