

THIS DOCUMENT IS SUBJECT TO CHANGE WITHOUT NOTICE. IT IS CONFIDENTIAL AND A PROPERTY OF AMPHENOL LTW. DISCLOSURE TO THIRD PARTY HAS TO BE AUTHORIZED BY AMPHENOL LTW.

REV.	ECN NO.	DATE	SIGN	DESCRIPTION
A		2022-03-07	Jiahe Lin	Rev.01 To Rev.A

MSBS-XXPFFR-EE0001
 XX: No. Of Pin

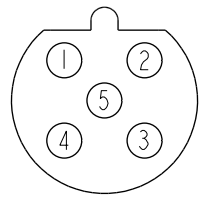
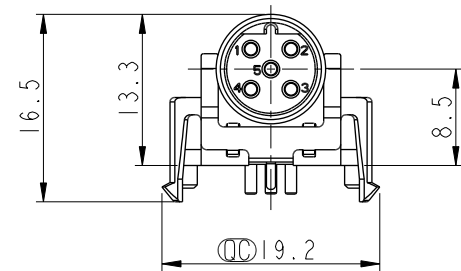
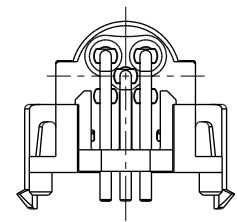
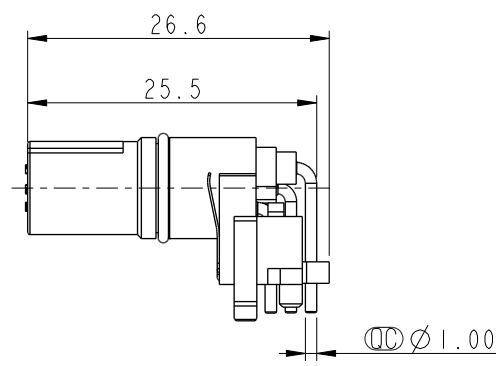
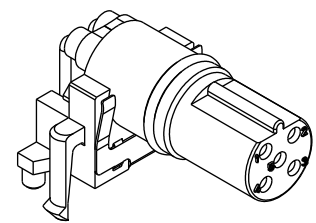
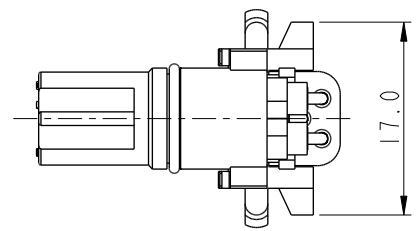

5P

Pin Assignments
Front View

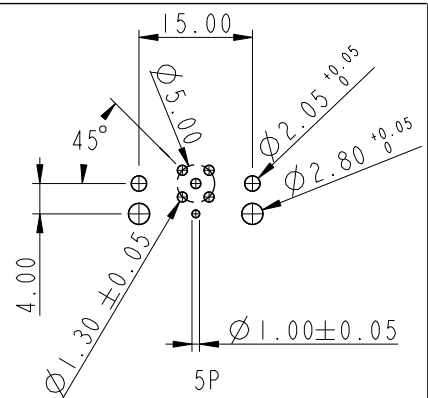

PCB Layout

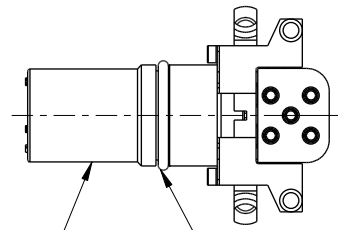

Connector O-Ring

Note:

- * RoHS Compliant
- * \varnothing Important dimension
- * Waterproof rate: Non-Waterproof
- * Connector
- Housing: Thermoplastic, Black
- Pin: Copper alloy, Gold plated
- O-Ring: Rubber, Gray
- * For pcb thickness max: 1.6mm

UNIT:mm		
TOLERANCE	.X ±0.25	
.XX	±0.1	
.XXX	±0.05	
ANGLES	±1°	

TITLE N SEN, M12 B -SHLD, RECEPTACLE, F, F, PCB R		
SCALE 3:2	SIZE A4	SHEET 1 OF 1
REV. A	WC-REV. A.1	\varnothing : Inspection item

Amphenol LTW
 安費諾亮泰企業股份有限公司

ITEM NO	DRAWN BY Jiahe Lin	DATE 2022-03-07
DWG NO MSBS-XXPFFR-EE0001	CHECKED BY Allen Pan	DATE 2022-03-07
CUSTOMER ALTW	APPROVED BY Fred Lee	DATE 2022-03-07

X-ON Electronics

Largest Supplier of Electrical and Electronic Components

Click to view similar products for [Circular Metric Connectors](#) category:

Click to view products by [Amphenol](#) manufacturer:

Other Similar products are found below :

[600X518037X](#) [MA1EAF1200](#) [6STD15PCR99B70A](#) [8R4000A16M020](#) [8R4A00A18M020](#) [8R5000A16M005](#) [1200910008](#) [1200910011](#)
[1300140094](#) [130203-0054](#) [1300150099](#) [RF-12S1N8A90DU](#) [1-3637-600-5205](#) [1612618](#) [8R4006A16M010](#) [8R5006A18A120](#) [1604232](#)
[1R3006A20M005](#) [RF-12P1N8A80DU](#) [RF-12P1N8A90DU](#) [41-01016](#) [41-40011](#) [41-40017](#) [42-01015](#) [4-22279-4](#) [4-22281-1](#) [4-22284-9](#) [43-](#)
[00002](#) [43-01166](#) [41-40005](#) [41-40016](#) [43-00161](#) [43-01191](#) [XS3P-M421-2](#) [600X518050X](#) [SACC-DSI-FS-5P-PG9-L180 SC](#) [8R4006A16A120](#)
[8R4000A16M010](#) [RKC 50/16](#) [1R3004A20A1201](#) [6-22279-3](#) [N03FA03144](#) [1300140077](#) [XS8A-0441](#) [859RD04-103R004](#) [860RD04-113R004](#)
[860RD04-213R004](#) [860-X08-213R004](#) [1-213245-2](#) [2273142-2](#)