

THIS DOCUMENT IS SUBJECT TO CHANGE WITHOUT NOTICE. IT IS CONFIDENTIAL AND A PROPERTY OF Amphenol LTW. DISCLOSURE TO THIRD PARTY HAS TO BE AUTHORIZED BY Amphenol LTW.

REV.	ECN NO.	DATE	SIGN	DESCRIPTION
A	Initial Release	2015/08/03	Feng_Li	Change Rev.01 To Rev.A
B	LEN16A0097-099	2016/10/14	Yulong_wang	Add 3, 5Pin, IP69K & Cat5e Cable.

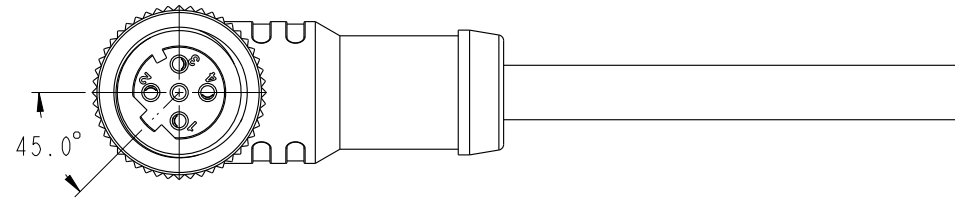
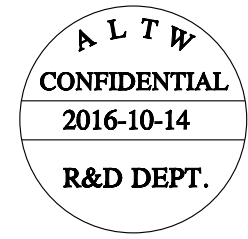
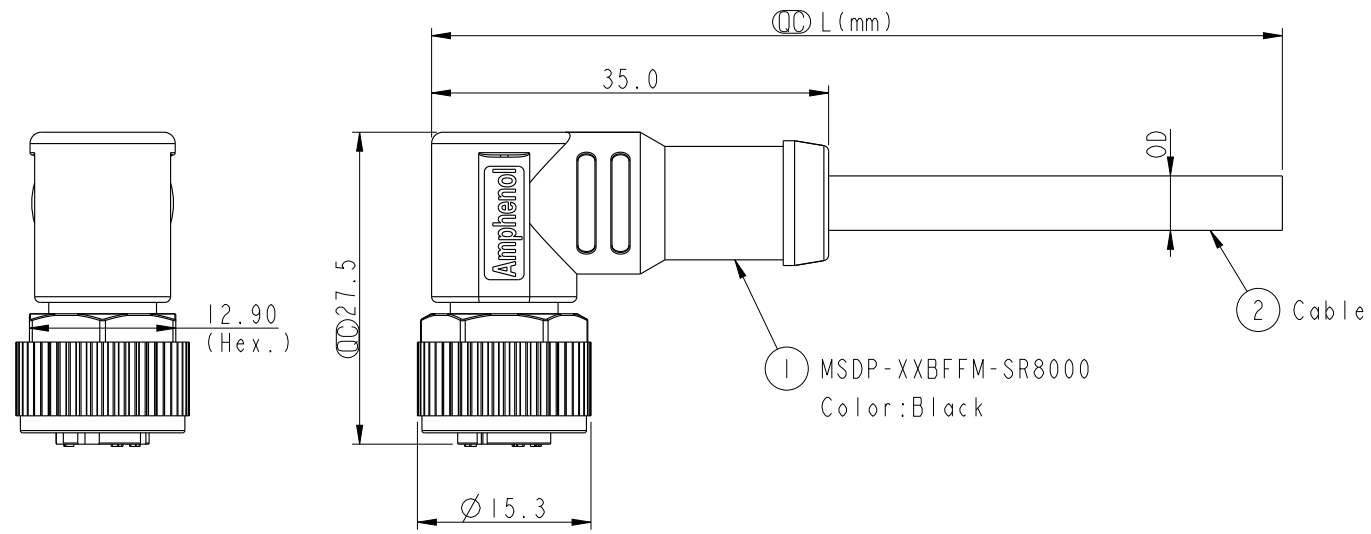

- Notes:
- * \varnothing Important Dimension.
 - $\triangle B$ * Waterproof Rate: IP68, IP69K.
 - * Connector: PU+GF, Black.
 - * Female Pin: Copper Alloy, Gold Plated.
 - * Screw Nut: Nylon, Black.
 - * Outer Mold: PU, Black.
 - $\triangle B$ * Cable: (A) UL2517,PVC Jacket, Yellow.
(B) UL20549,PUR Jacket, Black.
(D) UL2517,PVC Jacket, Black.
(E) CAT5E, PU Jacket, Black.
 - $\triangle B$ * Rated Voltage: 3 & 4Pin 250V dc. or ac.
5Pin 60V dc. or ac.
 - * Rated Current: 4A
 - * Operating Temperature: -25~+85°C
 - * Cable Length Tolerance: 01M:±40mm
02M~05M:±60mm
06M~10M:±100mm
11M~30M:±200mm
31M~99M:±500mm

UNIT:mm TOLERANCE ±0.5mm

TITLE M12 D Type 90° Female Conn.			
SCALE 3:2	SIZE A4	SHEET 1 OF 2	
REV. B	WC-REV. A.2	\varnothing : Inspection item	

Amphenol LTW
安費諾亮泰企業股份有限公司

ITEM NO	DRAWN BY Yulong_wang	DATE 2016-10-14
DWG NO MSDP-XXBFFM-SR8XXX	CHECKED BY Jinhai	DATE 2016-10-14
CUSTOMER ALTW	APPROVED BY Jerry	DATE 2016-10-14

THIS DOCUMENT IS SUBJECT TO CHANGE WITHOUT NOTICE. IT IS CONFIDENTIAL AND A PROPERTY OF Amphenol LTW. DISCLOSURE TO THIRD PARTY HAS TO BE AUTHORIZED BY Amphenol LTW.

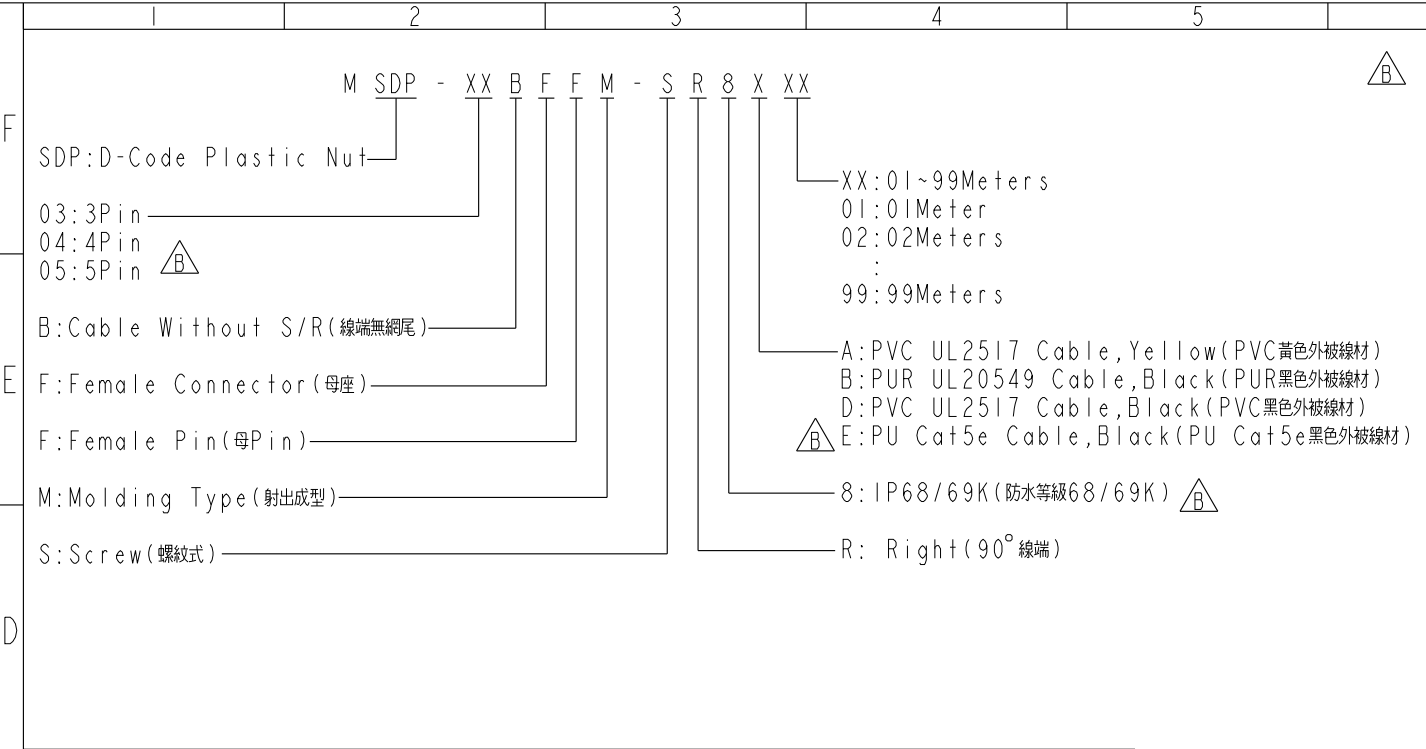

4P	PU	6.2	22	MSDP-04BFFM-SR8EXX
5P	PVC	5.1		MSDP-05BFFM-SR8DXX
4P		4.8		MSDP-04BFFM-SR8DXX
3P		4.5		MSDP-03BFFM-SR8DXX
5P	PUR	4.4		MSDP-05BFFM-SR8BXX
4P		4.0		MSDP-04BFFM-SR8BXX
3P	PVC	3.8		MSDP-03BFFM-SR8BXX
5P		5.1		MSDP-05BFFM-SR8AXX
4P		4.8		MSDP-04BFFM-SR8AXX
3P	4.5	MSDP-03BFFM-SR8AXX		
Contacts	Cable Jacket	Cable OD	AWG	Item No.

5	--	5	--	5	Gray	灰		
4	Black	4	Black	4	Black	黑	4	Green
3	Blue	3	Blue	3	Blue	藍	2	White/Green
2	--	2	White	2	White	白	3	Orange
1	Brown	1	Brown	1	Brown	棕	1	White/Orange
Pin #	Wire	Pin #	Wire	Pin #	Wire		Pin #	Wire (Cat5e)

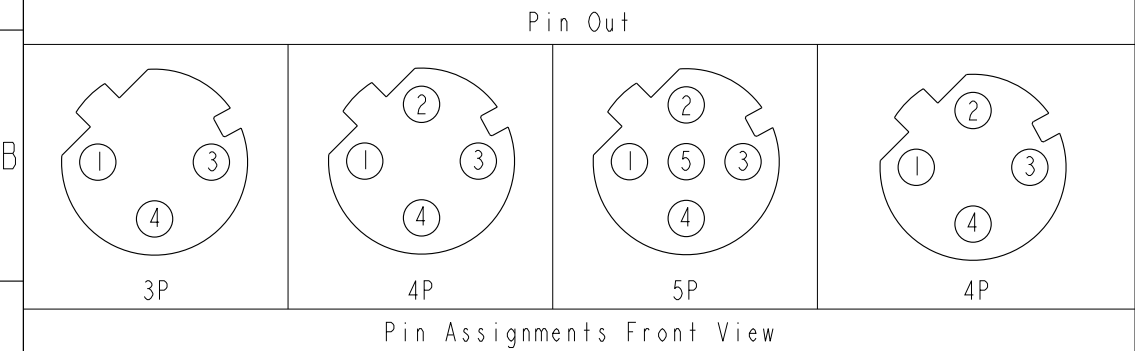
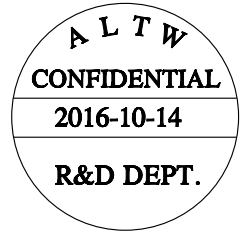
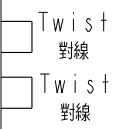

UNIT: mm TOLERANCE ±0.5mm	TITLE M12 D Type 90° Female Conn.		Amphenol LTW 安費諾亮泰企業股份有限公司		ITEM NO	DRAWN BY Yulong_wang	DATE 2016-10-14
	SCALE 3:2	SIZE A4			SHEET 2 OF 2	DWG NO MSDP-XXBFFM-SR8XXX	CHECKED BY Jinhai
	REV. B	WC-REV. A.2	☉: Inspection item		CUSTOMER ALTW	APPROVED BY Jerry	DATE 2016-10-14

X-ON Electronics

Largest Supplier of Electrical and Electronic Components

Click to view similar products for [Sensor Cables / Actuator Cables](#) category:

Click to view products by [Amphenol](#) manufacturer:

Other Similar products are found below :

[60963](#) [60964](#) [703000D02F2002](#) [703001D02F0602](#) [703001D02F300](#) [704000D02F120](#) [773032K02F030](#) [802027107404-1](#) [802027213811-1](#)
[804001A09M150](#) [805001A09M0502](#) [84914-0235](#) [84914-0237](#) [885030A09M020](#) [8R4J30E03C3003](#) [1200651332](#) [1200651713](#) [1200660844](#)
[1200660845](#) [1200661173](#) [1200680071](#) [1200720053](#) [1200720081](#) [1200720099](#) [1200720217](#) [1200800231](#) [1200860125](#) [1200870123](#)
[1200980102](#) [1200650267](#) [1200650298](#) [1200660183](#) [1200660782](#) [1200660849](#) [1200661295](#) [1200661297](#) [1200661342](#) [1200661343](#)
[1200670080](#) [1200670220](#) [1200680331](#) [1200720252](#) [1200730184](#) [1200860344](#) [1200870359](#) [1200870643](#) [1200980008](#) [1200980031](#)
[1210502211](#) [1210400542](#)